

Standard Development Timeline

This section is maintained by the drafting team during the development of the standard and will be removed when the standard is adopted by the NERC Board of Trustees (Board).

Description of Current Draft

This is the first draft of proposed standard for formal 45-day comment period.

Completed Actions	Date
Standards Committee approved Standard Authorization Request (SAR) for posting	February 20, 2019
SAR posted for comment	February 25 – March 27, 2019

Anticipated Actions	Date
45-day formal comment period with ballot	July – September 2019
45-day formal comment period with additional ballot	October – December 2019
45-day formal comment period with second additional ballot	January – March 2020
10-day final ballot	April 2020
Board adoption	May 2020

A. Introduction

1. **Title:** Transmission System Planned Performance for Geomagnetic Disturbance Events
2. **Number:** TPL-007-~~43~~
3. **Purpose:** Establish requirements for Transmission system planned performance during geomagnetic disturbance (GMD) events.
4. **Applicability:**
 - 4.1. **Functional Entities:**
 - 4.1.1. Planning Coordinator with a planning area that includes a Facility or Facilities specified in 4.2;
 - 4.1.2. Transmission Planner with a planning area that includes a Facility or Facilities specified in 4.2;
 - 4.1.3. Transmission Owner who owns a Facility or Facilities specified in 4.2; and
 - 4.1.4. Generator Owner who owns a Facility or Facilities specified in 4.2.
 - 4.2. **Facilities:**
 - 4.2.1. Facilities that include power transformer(s) with a high side, wye-grounded winding with terminal voltage greater than 200 kV.
5. **Effective Date:** See Implementation Plan for TPL-007-~~43~~.
- ~~6.~~ **Background:** During a GMD event, geomagnetically-induced currents (GIC) may cause transformer hot-spot heating or damage, loss of Reactive Power sources, increased Reactive Power demand, and Misoperation(s), the combination of which may result in voltage collapse and blackout.
- ~~7.6.~~ ~~The only difference between TPL 007 3 and TPL 007 2 is that TPL 007 3 adds a Canadian Variance to address regulatory practices/processes within Canadian jurisdictions and to allow the use of Canadian specific data and research to define and implement alternative GMD event(s) that achieve at least an equivalent reliability objective of that in TPL-007-2.~~

B. Requirements and Measures

- R1. Each Planning Coordinator, in conjunction with its Transmission Planner(s), shall identify the individual and joint responsibilities of the Planning Coordinator and Transmission Planner(s) in the Planning Coordinator's planning for maintaining models, performing the study or studies needed to complete benchmark and supplemental GMD Vulnerability Assessments, and implementing process(es) to obtain GMD measurement data as specified in this standard. *[Violation Risk Factor: Lower] [Time Horizon: Long-term Planning]*

- M1.** Each Planning Coordinator, in conjunction with its Transmission Planners, shall provide documentation on roles and responsibilities, such as meeting minutes, agreements, copies of procedures or protocols in effect between entities or between departments of a vertically integrated system, or email correspondence that identifies an agreement has been reached on individual and joint responsibilities for maintaining models, performing the study or studies needed to complete benchmark and supplemental GMD Vulnerability Assessments, and implementing process(es) to obtain GMD measurement data in accordance with Requirement R1.
- R2.** Each responsible entity, as determined in Requirement R1, shall maintain System models and GIC System models of the responsible entity’s planning area for performing the study or studies needed to complete benchmark and supplemental GMD Vulnerability Assessments. *[Violation Risk Factor: High] [Time Horizon: Long-term Planning]*
- M2.** Each responsible entity, as determined in Requirement R1, shall have evidence in either electronic or hard copy format that it is maintaining System models and GIC System models of the responsible entity’s planning area for performing the study or studies needed to complete benchmark and supplemental GMD Vulnerability Assessments.
- R3.** Each responsible entity, as determined in Requirement R1, shall have criteria for acceptable System steady state voltage performance for its System during the GMD events described in Attachment 1. *[Violation Risk Factor: Medium] [Time Horizon: Long-term Planning]*
- M3.** Each responsible entity, as determined in Requirement R1, shall have evidence, such as electronic or hard copies of the criteria for acceptable System steady state voltage performance for its System in accordance with Requirement R3.

Benchmark GMD Vulnerability Assessment(s)

- R4.** Each responsible entity, as determined in Requirement R1, shall complete a benchmark GMD Vulnerability Assessment of the Near-Term Transmission Planning Horizon at least once every 60 calendar months. This benchmark GMD Vulnerability Assessment shall use a study or studies based on models identified in Requirement R2, document assumptions, and document summarized results of the steady state analysis. *[Violation Risk Factor: High] [Time Horizon: Long-term Planning]*
- 4.1.** The study or studies shall include the following conditions:
- 4.1.1.** System On-Peak Load for at least one year within the Near-Term Transmission Planning Horizon; and
 - 4.1.2.** System Off-Peak Load for at least one year within the Near-Term Transmission Planning Horizon.

- 4.2.** The study or studies shall be conducted based on the benchmark GMD event described in Attachment 1 to determine whether the System meets the performance requirements for the steady state planning benchmark GMD event contained in Table 1.
- 4.3.** The benchmark GMD Vulnerability Assessment shall be provided: (i) to the responsible entity's Reliability Coordinator, adjacent Planning Coordinators, and adjacent Transmission Planners within 90 calendar days of completion, and (ii) to any functional entity that submits a written request and has a reliability-related need within 90 calendar days of receipt of such request or within 90 calendar days of completion of the benchmark GMD Vulnerability Assessment, whichever is later.
- 4.3.1.** If a recipient of the benchmark GMD Vulnerability Assessment provides documented comments on the results, the responsible entity shall provide a documented response to that recipient within 90 calendar days of receipt of those comments.
- M4.** Each responsible entity, as determined in Requirement R1, shall have dated evidence such as electronic or hard copies of its benchmark GMD Vulnerability Assessment meeting all of the requirements in Requirement R4. Each responsible entity, as determined in Requirement R1, shall also provide evidence, such as email records, web postings with an electronic notice of posting, or postal receipts showing recipient and date, that it has distributed its benchmark GMD Vulnerability Assessment: (i) to the responsible entity's Reliability Coordinator, adjacent Planning Coordinators, and adjacent Transmission Planners within 90 calendar days of completion, and (ii) to any functional entity that submits a written request and has a reliability-related need within 90 calendar days of receipt of such request or within 90 calendar days of completion of the benchmark GMD Vulnerability Assessment, whichever is later, as specified in Requirement R4. Each responsible entity, as determined in Requirement R1, shall also provide evidence, such as email notices or postal receipts showing recipient and date, that it has provided a documented response to comments received on its benchmark GMD Vulnerability Assessment within 90 calendar days of receipt of those comments in accordance with Requirement R4.
- R5.** Each responsible entity, as determined in Requirement R1, shall provide GIC flow information to be used for the benchmark thermal impact assessment of transformers specified in Requirement R6 to each Transmission Owner and Generator Owner that owns an applicable Bulk Electric System (BES) power transformer in the planning area. The GIC flow information shall include: *[Violation Risk Factor: Medium] [Time Horizon: Long-term Planning]*
- 5.1.** The maximum effective GIC value for the worst case geoelectric field orientation for the benchmark GMD event described in Attachment 1. This value shall be provided to the Transmission Owner or Generator Owner that owns each applicable BES power transformer in the planning area.

- 5.2.** The effective GIC time series, GIC(t), calculated using the benchmark GMD event described in Attachment 1 in response to a written request from the Transmission Owner or Generator Owner that owns an applicable BES power transformer in the planning area. GIC(t) shall be provided within 90 calendar days of receipt of the written request and after determination of the maximum effective GIC value in Part 5.1.
- M5.** Each responsible entity, as determined in Requirement R1, shall provide evidence, such as email records, web postings with an electronic notice of posting, or postal receipts showing recipient and date, that it has provided the maximum effective GIC values to the Transmission Owner and Generator Owner that owns each applicable BES power transformer in the planning area as specified in Requirement R5, Part 5.1. Each responsible entity, as determined in Requirement R1, shall also provide evidence, such as email records, web postings with an electronic notice of posting, or postal receipts showing recipient and date, that it has provided GIC(t) in response to a written request from the Transmission Owner or Generator Owner that owns an applicable BES power transformer in the planning area.
- R6.** Each Transmission Owner and Generator Owner shall conduct a benchmark thermal impact assessment for its solely and jointly owned applicable BES power transformers where the maximum effective GIC value provided in Requirement R5, Part 5.1, is 75 A per phase or greater. The benchmark thermal impact assessment shall: *[Violation Risk Factor: Medium] [Time Horizon: Long-term Planning]*
- 6.1.** Be based on the effective GIC flow information provided in Requirement R5;
- 6.2.** Document assumptions used in the analysis;
- 6.3.** Describe suggested actions and supporting analysis to mitigate the impact of GICs, if any; and
- 6.4.** Be performed and provided to the responsible entities, as determined in Requirement R1, within 24 calendar months of receiving GIC flow information specified in Requirement R5, Part 5.1.
- M6.** Each Transmission Owner and Generator Owner shall have evidence such as electronic or hard copies of its benchmark thermal impact assessment for all of its solely and jointly owned applicable BES power transformers where the maximum effective GIC value provided in Requirement R5, Part 5.1, is 75 A per phase or greater, and shall have evidence such as email records, web postings with an electronic notice of posting, or postal receipts showing recipient and date, that it has provided its thermal impact assessment to the responsible entities as specified in Requirement R6.
- R7.** Each responsible entity, as determined in Requirement R1, that concludes through the benchmark GMD Vulnerability Assessment conducted in Requirement R4 that their System does not meet the performance requirements for the steady state planning benchmark GMD event contained in Table 1, shall develop a Corrective

Action Plan (CAP) addressing how the performance requirements will be met. The CAP shall: *[Violation Risk Factor: High] [Time Horizon: Long-term Planning]*

7.1. List System deficiencies and the associated actions needed to achieve required System performance. Examples of such actions include:

- Installation, modification, retirement, or removal of Transmission and generation Facilities and any associated equipment.
- Installation, modification, or removal of Protection Systems or Remedial Action Schemes.
- Use of Operating Procedures, specifying how long they will be needed as part of the CAP.
- Use of Demand-Side Management, new technologies, or other initiatives.

7.2. Be developed within one year of completion of the benchmark GMD Vulnerability Assessment.

7.3. Include a timetable, subject to ~~revision by the responsible entity~~ ERO approval for any extension sought under in Part 7.4, for implementing the selected actions from Part 7.1. The timetable shall:

7.3.1. Specify implementation of non-hardware mitigation, if any, within two years of development of the CAP; and

7.3.2. Specify implementation of hardware mitigation, if any, within four years of development of the CAP.

7.4. Be submitted to the ERO with a request for extension ~~revised if situations beyond the control of the responsible entity is unable to determined in Requirement R1 prevent implementation of~~ the CAP within the timetable ~~for implementation~~ provided in Part 7.3. The ~~submitted revised~~ CAP shall document the following, ~~and be updated at least once every 12 calendar months until implemented~~:

~~7.4.1.~~ Circumstances causing the delay for fully or partially implementing the selected actions in Part 7.1 and how those circumstances are beyond the control of the responsible entity;

~~7.4.2, 7.4.1.~~ Description of the original CAP, and any previous changes to the CAP, with the associated timetable(s) for implementing the selected actions in Part 7.1; and

7.4.2. Revisions to the selected actions in Part 7.1, if any, including utilization of Operating Procedures, if applicable; and;

7.4.3. ~~and the U~~ updated timetable for implementing the selected actions in Part 7.1.

- 7.5. Be provided: (i) to the responsible entity's Reliability Coordinator, adjacent Planning Coordinator(s), adjacent Transmission Planner(s), and functional entities referenced in the CAP within 90 calendar days of development or revision, and (ii) to any functional entity that submits a written request and has a reliability-related need within 90 calendar days of receipt of such request or within 90 calendar days of development or revision, whichever is later.
- 7.5.1. If a recipient of the CAP provides documented comments on the CAP results, the responsible entity shall provide a documented response to that recipient within 90 calendar days of receipt of those comments.
- M7. Each responsible entity, as determined in Requirement R1, that concludes, through the benchmark GMD Vulnerability Assessment conducted in Requirement R4, that the responsible entity's System does not meet the performance requirements for the steady state planning benchmark GMD event contained in Table 1 shall have evidence such as dated electronic or hard copies of its CAP including timetable for implementing selected actions, as specified in Requirement R7. Each responsible entity, as determined in Requirement R1, shall also provide evidence, such as email records or postal receipts showing recipient and date, that it submitted a request for extension to the ERO if has revised its CAP if situations beyond the responsible entity's is unable to control prevent implementation of the CAP within the timetable provided in Part 7.3 specified. Each responsible entity, as determined in Requirement R1, shall also provide evidence, such as email records, web postings with an electronic notice of posting, or postal receipts showing recipient and date, that it has distributed its CAP or relevant information, if any, (i) to the responsible entity's Reliability Coordinator, adjacent Planning Coordinator(s), adjacent Transmission Planner(s), and functional entities referenced in the CAP within 90 calendar days of development or revision, and (ii) to any functional entity that submits a written request and has a reliability-related need within 90 calendar days of receipt of such request or within 90 calendar days of development or revision, whichever is later as specified in Requirement R7. Each responsible entity, as determined in Requirement R1, shall also provide evidence, such as email notices or postal receipts showing recipient and date, that it has provided a documented response to comments received on its CAP within 90 calendar days of receipt of those comments, in accordance with Requirement R7.

Supplemental GMD Vulnerability Assessment(s)

- R8. Each responsible entity, as determined in Requirement R1, shall complete a supplemental GMD Vulnerability Assessment of the Near-Term Transmission Planning Horizon at least once every 60 calendar months. This supplemental GMD Vulnerability Assessment shall use a study or studies based on models identified in Requirement R2, document assumptions, and document summarized results of the steady state analysis. *[Violation Risk Factor: High] [Time Horizon: Long-term Planning]*
- 8.1. The study or studies shall include the following conditions:

8.1.1. System On-Peak Load for at least one year within the Near-Term Transmission Planning Horizon; and

8.1.2. System Off-Peak Load for at least one year within the Near-Term Transmission Planning Horizon.

8.2. The study or studies shall be conducted based on the supplemental GMD event described in Attachment 1 to determine whether the System meets the performance requirements for the steady state planning supplemental GMD event contained in Table 1.

~~8.3. If the analysis concludes there is Cascading caused by the supplemental GMD event described in Attachment 1, an evaluation of possible actions designed to reduce the likelihood or mitigate the consequences and adverse impacts of the event(s) shall be conducted.~~

8.4.8.3. The supplemental GMD Vulnerability Assessment shall be provided: (i) to the responsible entity's Reliability Coordinator, adjacent Planning Coordinators, adjacent Transmission Planners within 90 calendar days of completion, and (ii) to any functional entity that submits a written request and has a reliability-related need within 90 calendar days of receipt of such request or within 90 calendar days of completion of the supplemental GMD Vulnerability Assessment, whichever is later.

8.4.1.8.3.1. If a recipient of the supplemental GMD Vulnerability Assessment provides documented comments on the results, the responsible entity shall provide a documented response to that recipient within 90 calendar days of receipt of those comments.

M8. Each responsible entity, as determined in Requirement R1, shall have dated evidence such as electronic or hard copies of its supplemental GMD Vulnerability Assessment meeting all of the requirements in Requirement R8. Each responsible entity, as determined in Requirement R1, shall also provide evidence, such as email records, web postings with an electronic notice of posting, or postal receipts showing recipient and date, that it has distributed its supplemental GMD Vulnerability Assessment: (i) to the responsible entity's Reliability Coordinator, adjacent Planning Coordinators, adjacent Transmission Planners within 90 calendar days of completion, and (ii) to any functional entity that submits a written request and has a reliability-related need within 90 calendar days of receipt of such request or within 90 calendar days of completion of the supplemental GMD Vulnerability Assessment, whichever is later, as specified in Requirement R8. Each responsible entity, as determined in Requirement R1, shall also provide evidence, such as email notices or postal receipts showing recipient and date, that it has provided a documented response to comments received on its supplemental GMD Vulnerability Assessment within 90 calendar days of receipt of those comments in accordance with Requirement R8.

- R9.** Each responsible entity, as determined in Requirement R1, shall provide GIC flow information to be used for the supplemental thermal impact assessment of transformers specified in Requirement R10 to each Transmission Owner and Generator Owner that owns an applicable Bulk Electric System (BES) power transformer in the planning area. The GIC flow information shall include: *[Violation Risk Factor: Medium] [Time Horizon: Long-term Planning]*
- 9.1.** The maximum effective GIC value for the worst case geoelectric field orientation for the supplemental GMD event described in Attachment 1. This value shall be provided to the Transmission Owner or Generator Owner that owns each applicable BES power transformer in the planning area.
- 9.2.** The effective GIC time series, GIC(t), calculated using the supplemental GMD event described in Attachment 1 in response to a written request from the Transmission Owner or Generator Owner that owns an applicable BES power transformer in the planning area. GIC(t) shall be provided within 90 calendar days of receipt of the written request and after determination of the maximum effective GIC value in Part 9.1.
- M9.** Each responsible entity, as determined in Requirement R1, shall provide evidence, such as email records, web postings with an electronic notice of posting, or postal receipts showing recipient and date, that it has provided the maximum effective GIC values to the Transmission Owner and Generator Owner that owns each applicable BES power transformer in the planning area as specified in Requirement R9, Part 9.1. Each responsible entity, as determined in Requirement R1, shall also provide evidence, such as email records, web postings with an electronic notice of posting, or postal receipts showing recipient and date, that it has provided GIC(t) in response to a written request from the Transmission Owner or Generator Owner that owns an applicable BES power transformer in the planning area.
- R10.** Each Transmission Owner and Generator Owner shall conduct a supplemental thermal impact assessment for its solely and jointly owned applicable BES power transformers where the maximum effective GIC value provided in Requirement R9, Part 9.1, is 85 A per phase or greater. The supplemental thermal impact assessment shall: *[Violation Risk Factor: Medium] [Time Horizon: Long-term Planning]*
- 10.1.** Be based on the effective GIC flow information provided in Requirement R9;
- 10.2.** Document assumptions used in the analysis;
- 10.3.** Describe suggested actions and supporting analysis to mitigate the impact of GICs, if any; and
- 10.4.** Be performed and provided to the responsible entities, as determined in Requirement R1, within 24 calendar months of receiving GIC flow information specified in Requirement R9, Part 9.1.

M10. Each Transmission Owner and Generator Owner shall have evidence such as electronic or hard copies of its supplemental thermal impact assessment for all of its solely and jointly owned applicable BES power transformers where the maximum effective GIC value provided in Requirement R9, Part 9.1, is 85 A per phase or greater, and shall have evidence such as email records, web postings with an electronic notice of posting, or postal receipts showing recipient and date, that it has provided its supplemental thermal impact assessment to the responsible entities as specified in Requirement R10.

R11. Each responsible entity, as determined in Requirement R1, that concludes through the supplemental GMD Vulnerability Assessment conducted in Requirement R8 that their System does not meet the performance requirements for the steady state planning supplemental GMD event contained in Table 1, shall develop a Corrective Action Plan (CAP) addressing how the performance requirements will be met. The CAP shall: [Violation Risk Factor: High] [Time Horizon: Long-term Planning]

11.1. List System deficiencies and the associated actions needed to achieve required System performance. Examples of such actions include:

- Installation, modification, retirement, or removal of Transmission and generation Facilities and any associated equipment.
- Installation, modification, or removal of Protection Systems or Remedial Action Schemes.
- Use of Operating Procedures, specifying how long they will be needed as part of the CAP.
- Use of Demand-Side Management, new technologies, or other initiatives.

11.2. Be developed within one year of completion of the supplemental GMD Vulnerability Assessment.

11.3. Include a timetable, subject to ERO approval for any extension sought under Part 11.4, for implementing the selected actions from Part 11.1. The timetable shall:

11.3.1. Specify implementation of non-hardware mitigation, if any, within two years of development of the CAP; and

11.3.2. Specify implementation of hardware mitigation, if any, within four years of development of the CAP.

11.4. Be submitted to the ERO with a request for extension if the responsible entity is unable to implement the CAP within the timetable provided in Part 11.3. The submitted CAP shall document the following:

11.4.1. Circumstances causing the delay for fully or partially implementing the selected actions in Part 11.1 and how those circumstances are beyond the control of the responsible entity;

11.4.2. Revisions to the selected actions in Part 11.1, if any, including utilization of Operating Procedures, if applicable; and

11.4.3. Updated timetable for implementing the selected actions in Part 11.1.

11.5. Be provided: (i) to the responsible entity's Reliability Coordinator, adjacent Planning Coordinator(s), adjacent Transmission Planner(s), and functional entities referenced in the CAP within 90 calendar days of development or revision, and (ii) to any functional entity that submits a written request and has a reliability-related need within 90 calendar days of receipt of such request or within 90 calendar days of development or revision, whichever is later.

11.5.1. If a recipient of the CAP provides documented comments on the CAP, the responsible entity shall provide a documented response to that recipient within 90 calendar days of receipt of those comments.

M11. Each responsible entity, as determined in Requirement R1, that concludes, through the supplemental GMD Vulnerability Assessment conducted in Requirement R8, that the responsible entity's System does not meet the performance requirements for the steady state planning supplemental GMD event contained in Table 1 shall have evidence such as dated electronic or hard copies of its CAP including timetable for implementing selected actions, as specified in Requirement R11. Each responsible entity, as determined in Requirement R1, shall also provide evidence, such as email records or postal receipts showing recipient and date, that it submitted a request for extension to the ERO if the responsible entity is unable to implement the CAP within the timetable provided in Part 11.3. Each responsible entity, as determined in Requirement R1, shall also provide evidence, such as email records, web postings with an electronic notice of posting, or postal receipts showing recipient and date, that it has distributed its CAP or relevant information, if any, (i) to the responsible entity's Reliability Coordinator, adjacent Planning Coordinator(s), adjacent Transmission Planner(s), and functional entities referenced in the CAP within 90 calendar days of development or revision, and (ii) to any functional entity that submits a written request and has a reliability-related need within 90 calendar days of receipt of such request or within 90 calendar days of development or revision, whichever is later as specified in Requirement R11. Each responsible entity, as determined in Requirement R1, shall also provide evidence, such as email notices or postal receipts showing recipient and date, that it has provided a documented response to comments received on its CAP within 90 calendar days of receipt of those comments, in accordance with Requirement R11.

GMD Measurement Data Processes

~~R11~~-~~R12~~. Each responsible entity, as determined in Requirement R1, shall implement a process to obtain GIC monitor data from at least one GIC monitor located in the Planning Coordinator's planning area or other part of the system included in the Planning Coordinator's GIC System model. *[Violation Risk Factor: Lower] [Time Horizon: Long-term Planning]*

~~M10~~-~~M12~~. Each responsible entity, as determined in Requirement R1, shall have evidence such as electronic or hard copies of its GIC monitor location(s) and documentation of its process to obtain GIC monitor data in accordance with Requirement R1~~2~~**1**.

~~R12~~-~~R13~~. Each responsible entity, as determined in Requirement R1, shall implement a process to obtain geomagnetic field data for its Planning Coordinator's planning area. *[Violation Risk Factor: Lower] [Time Horizon: Long-term Planning]*

~~M11~~-~~M13~~. Each responsible entity, as determined in Requirement R1, shall have evidence such as electronic or hard copies of its process to obtain geomagnetic field data for its Planning Coordinator's planning area in accordance with Requirement R1~~3~~**2**.

B-C. Compliance

1. Compliance Monitoring Process

1.1. Compliance Enforcement Authority: "Compliance Enforcement Authority" means NERC or the Regional Entity, or any entity as otherwise designated by an Applicable Governmental Authority, in their respective roles of monitoring and/or enforcing compliance with mandatory and enforceable Reliability Standards in their respective jurisdictions.

1.2. Evidence Retention: The following evidence retention period(s) identify the period of time an entity is required to retain specific evidence to demonstrate compliance. For instances where the evidence retention period specified below is shorter than the time since the last audit, the Compliance Enforcement Authority may ask an entity to provide other evidence to show that it was compliant for the full-time period since the last audit.

The applicable entity shall keep data or evidence to show compliance as identified below unless directed by its Compliance Enforcement Authority to retain specific evidence for a longer period of time as part of an investigation.

- For Requirements R1, R2, R3, R5, R6, R9, and R10, each responsible entity shall retain documentation as evidence for five years.
- For Requirements R4 and R8, each responsible entity shall retain documentation of the current GMD Vulnerability Assessment and the preceding GMD Vulnerability Assessment.

- For Requirement R7 and R11, each responsible entity shall retain documentation as evidence for five years or until all actions in the Corrective Action Plan are completed, whichever is later.
- For Requirements R1~~24~~ and R1~~32~~, each responsible entity shall retain documentation as evidence for three years.

1.3. Compliance Monitoring and Enforcement Program: As defined in the NERC Rules of Procedure, “Compliance Monitoring and Enforcement Program” refers to the identification of the processes that will be used to evaluate data or information for the purpose of assessing performance or outcomes with the associated Reliability Standard.

Table 1: Steady State Planning GMD Event

Steady State:

- a. Voltage collapse, Cascading and uncontrolled islanding shall not occur.
- b. Generation loss is acceptable as a consequence of the steady state planning GMD events.
- c. Planned System adjustments such as Transmission configuration changes and re-dispatch of generation are allowed if such adjustments are executable within the time duration applicable to the Facility Ratings.

Category	Initial Condition	Event	Interruption of Firm Transmission Service Allowed	Load Loss Allowed
Benchmark GMD Event – GMD Event with Outages	1. System as may be postured in response to space weather information ¹ , and then 2. GMD event ²	Reactive Power compensation devices and other Transmission Facilities removed as a result of Protection System operation or Misoperation due to harmonics during the GMD event	Yes ³	Yes ³
Supplemental GMD Event – GMD Event with Outages	1. System as may be postured in response to space weather information ¹ , and then 2. GMD event ²	Reactive Power compensation devices and other Transmission Facilities removed as a result of Protection System operation or Misoperation due to harmonics during the GMD event	Yes	Yes

Table 1: Steady State Performance Footnotes

1. The System condition for GMD planning may include adjustments to posture the System that are executable in response to space weather information.
2. The GMD conditions for the benchmark and supplemental planning events are described in Attachment 1.
3. Load loss as a result of manual or automatic Load shedding (e.g., UVLS) and/or curtailment of Firm Transmission Service may be used to meet BES performance requirements during studied GMD conditions. The likelihood and magnitude of Load loss or curtailment of Firm Transmission Service should be minimized.

Violation Severity Levels

R #	Violation Severity Levels			
	Lower VSL	Moderate VSL	High VSL	Severe VSL
R1.	N/A	N/A	N/A	The Planning Coordinator, in conjunction with its Transmission Planner(s), failed to determine and identify individual or joint responsibilities of the Planning Coordinator and Transmission Planner(s) in the Planning Coordinator’s planning area for maintaining models, performing the study or studies needed to complete benchmark and supplemental GMD Vulnerability Assessments, and implementing process(es) to obtain GMD measurement data as specified in this standard.
R2.	N/A	N/A	The responsible entity did not maintain either System models or GIC System models of the responsible entity’s planning area for performing the studies	The responsible entity did not maintain both System models and GIC System models of the responsible entity’s planning area for performing the studies

R #	Violation Severity Levels			
	Lower VSL	Moderate VSL	High VSL	Severe VSL
			needed to complete benchmark and supplemental GMD Vulnerability Assessments.	needed to complete benchmark and supplemental GMD Vulnerability Assessments.
R3.	N/A	N/A	N/A	The responsible entity did not have criteria for acceptable System steady state voltage performance for its System during the GMD events described in Attachment 1 as required.
R4.	The responsible entity completed a benchmark GMD Vulnerability Assessment, but it was more than 60 calendar months and less than or equal to 64 calendar months since the last benchmark GMD Vulnerability Assessment.	The responsible entity's completed benchmark GMD Vulnerability Assessment failed to satisfy one of the elements listed in Requirement R4, Parts 4.1 through 4.3; OR The responsible entity completed a benchmark GMD Vulnerability Assessment, but it was more than 64 calendar months and less than or equal to 68 calendar months since the	The responsible entity's completed benchmark GMD Vulnerability Assessment failed to satisfy two of the elements listed in Requirement R4, Parts 4.1 through 4.3; OR The responsible entity completed a benchmark GMD Vulnerability Assessment, but it was more than 68 calendar months and less than or equal to 72 calendar months since the	The responsible entity's completed benchmark GMD Vulnerability Assessment failed to satisfy three of the elements listed in Requirement R4, Parts 4.1 through 4.3; OR The responsible entity completed a benchmark GMD Vulnerability Assessment, but it was more than 72 calendar months since the last benchmark

R #	Violation Severity Levels			
	Lower VSL	Moderate VSL	High VSL	Severe VSL
		last benchmark GMD Vulnerability Assessment.	last benchmark GMD Vulnerability Assessment.	GMD Vulnerability Assessment; OR The responsible entity does not have a completed benchmark GMD Vulnerability Assessment.
R5.	The responsible entity provided the effective GIC time series, GIC(t), in response to written request, but did so more than 90 calendar days and less than or equal to 100 calendar days after receipt of a written request.	The responsible entity provided the effective GIC time series, GIC(t), in response to written request, but did so more than 100 calendar days and less than or equal to 110 calendar days after receipt of a written request.	The responsible entity provided the effective GIC time series, GIC(t), in response to written request, but did so more than 110 calendar days after receipt of a written request.	The responsible entity did not provide the maximum effective GIC value to the Transmission Owner and Generator Owner that owns each applicable BES power transformer in the planning area; OR The responsible entity did not provide the effective GIC time series, GIC(t), upon written request.
R6.	The responsible entity failed to conduct a benchmark thermal impact assessment for 5% or less or one of its solely owned and jointly owned applicable BES power	The responsible entity failed to conduct a benchmark thermal impact assessment for more than 5% up to (and including) 10% or two of its solely owned and jointly	The responsible entity failed to conduct a benchmark thermal impact assessment for more than 10% up to (and including) 15% or three of its solely owned and	The responsible entity failed to conduct a benchmark thermal impact assessment for more than 15% or more than three of its solely owned and jointly owned

R #	Violation Severity Levels			
	Lower VSL	Moderate VSL	High VSL	Severe VSL
	<p>transformers (whichever is greater) where the maximum effective GIC value provided in Requirement R5, Part 5.1, is 75 A or greater per phase; OR The responsible entity conducted a benchmark thermal impact assessment for its solely owned and jointly owned applicable BES power transformers where the maximum effective GIC value provided in Requirement R5, Part 5.1, is 75 A or greater per phase but did so more than 24 calendar months and less than or equal to 26 calendar months of receiving GIC flow information specified in Requirement R5, Part 5.1.</p>	<p>owned applicable BES power transformers (whichever is greater) where the maximum effective GIC value provided in Requirement R5, Part 5.1, is 75 A or greater per phase; OR The responsible entity conducted a benchmark thermal impact assessment for its solely owned and jointly owned applicable BES power transformers where the maximum effective GIC value provided in Requirement R5, Part 5.1, is 75 A or greater per phase but did so more than 26 calendar months and less than or equal to 28 calendar months of receiving GIC flow information specified in Requirement R5, Part 5.1; OR The responsible entity failed to include one of the</p>	<p>jointly owned applicable BES power transformers (whichever is greater) where the maximum effective GIC value provided in Requirement R5, Part 5.1, is 75 A or greater per phase; OR The responsible entity conducted a benchmark thermal impact assessment for its solely owned and jointly owned applicable BES power transformers where the maximum effective GIC value provided in Requirement R5, Part 5.1, is 75 A or greater per phase but did so more than 28 calendar months and less than or equal to 30 calendar months of receiving GIC flow information specified in Requirement R5, Part 5.1; OR The responsible entity failed to include two of the</p>	<p>applicable BES power transformers (whichever is greater) where the maximum effective GIC value provided in Requirement R5, Part 5.1, is 75 A or greater per phase; OR The responsible entity conducted a benchmark thermal impact assessment for its solely owned and jointly owned applicable BES power transformers where the maximum effective GIC value provided in Requirement R5, Part 5.1, is 75 A or greater per phase but did so more than 30 calendar months of receiving GIC flow information specified in Requirement R5, Part 5.1; OR The responsible entity failed to include three of the required elements as listed</p>

R #	Violation Severity Levels			
	Lower VSL	Moderate VSL	High VSL	Severe VSL
		required elements as listed in Requirement R6, Parts 6.1 through 6.3.	required elements as listed in Requirement R6, Parts 6.1 through 6.3.	in Requirement R6, Parts 6.1 through 6.3.
R7.	The responsible entity's Corrective Action Plan failed to comply with one of the elements in Requirement R7, Parts 7.1 through 7.5.	The responsible entity's Corrective Action Plan failed to comply with two of the elements in Requirement R7, Parts 7.1 through 7.5.	The responsible entity's Corrective Action Plan failed to comply with three of the elements in Requirement R7, Parts 7.1 through 7.5.	The responsible entity's Corrective Action Plan failed to comply with four or more of the elements in Requirement R7, Parts 7.1 through 7.5; OR The responsible entity did not develop have a Corrective Action Plan as required by Requirement R7.
R8.	The responsible entity's completed supplemental GMD Vulnerability Assessment failed to satisfy one of elements listed in Requirement R8, Parts 8.1 through 8.4; OR The responsible entity completed a supplemental GMD Vulnerability Assessment, but it was more	The responsible entity's completed supplemental GMD Vulnerability Assessment failed to satisfy two one of the elements listed in Requirement R8, Parts 8.1 through 8.34; OR The responsible entity completed a supplemental GMD Vulnerability Assessment, but it was more	The responsible entity's completed supplemental GMD Vulnerability Assessment failed to satisfy three two of the elements listed in Requirement R8, Parts 8.1 through 8.34; OR The responsible entity completed a supplemental GMD Vulnerability Assessment, but it was more	The responsible entity's completed supplemental GMD Vulnerability Assessment failed to satisfy three four of the elements listed in Requirement R8, Parts 8.1 through 8.34; OR The responsible entity completed a supplemental GMD Vulnerability Assessment, but it was more

R #	Violation Severity Levels			
	Lower VSL	Moderate VSL	High VSL	Severe VSL
	than 60 calendar months and less than or equal to 64 calendar months since the last supplemental GMD Vulnerability Assessment.	than 64 calendar months and less than or equal to 68 calendar months since the last supplemental GMD Vulnerability Assessment.	than 68 calendar months and less than or equal to 72 calendar months since the last supplemental GMD Vulnerability Assessment.	than 72 calendar months since the last supplemental GMD Vulnerability Assessment; OR The responsible entity does not have a completed supplemental GMD Vulnerability Assessment.
R9.	The responsible entity provided the effective GIC time series, GIC(t), in response to written request, but did so more than 90 calendar days and less than or equal to 100 calendar days after receipt of a written request.	The responsible entity provided the effective GIC time series, GIC(t), in response to written request, but did so more than 100 calendar days and less than or equal to 110 calendar days after receipt of a written request.	The responsible entity provided the effective GIC time series, GIC(t), in response to written request, but did so more than 110 calendar days after receipt of a written request.	The responsible entity did not provide the maximum effective GIC value to the Transmission Owner and Generator Owner that owns each applicable BES power transformer in the planning area; OR The responsible entity did not provide the effective GIC time series, GIC(t), upon written request.
R10.	The responsible entity failed to conduct a supplemental thermal impact assessment for 5% or less or one of its	The responsible entity failed to conduct a supplemental thermal impact assessment for more than 5% up to (and	The responsible entity failed to conduct a supplemental thermal impact assessment for more than 10% up to	The responsible entity failed to conduct a supplemental thermal impact assessment for more than 15% or more

R #	Violation Severity Levels			
	Lower VSL	Moderate VSL	High VSL	Severe VSL
	<p>solely owned and jointly owned applicable BES power transformers (whichever is greater) where the maximum effective GIC value provided in Requirement R9, Part 9.1, is 85 A or greater per phase;</p> <p>OR</p> <p>The responsible entity conducted a supplemental thermal impact assessment for its solely owned and jointly owned applicable BES power transformers where the maximum effective GIC value provided in Requirement R9, Part 9.1, is 85 A or greater per phase but did so more than 24 calendar months and less than or equal to 26 calendar months of receiving GIC flow information specified in Requirement R9, Part 9.1.</p>	<p>including) 10% or two of its solely owned and jointly owned applicable BES power transformers (whichever is greater) where the maximum effective GIC value provided in Requirement R9, Part 9.1, is 85 A or greater per phase;</p> <p>OR</p> <p>The responsible entity conducted a supplemental thermal impact assessment for its solely owned and jointly owned applicable BES power transformers where the maximum effective GIC value provided in Requirement R9, Part 9.1, is 85 A or greater per phase but did so more than 26 calendar months and less than or equal to 28 calendar months of receiving GIC flow information specified in Requirement R9, Part 9.1</p> <p>OR</p>	<p>(and including) 15% or three of its solely owned and jointly owned applicable BES power transformers (whichever is greater) where the maximum effective GIC value provided in Requirement R9, Part 9.1, is 85 A or greater per phase;</p> <p>OR</p> <p>The responsible entity conducted a supplemental thermal impact assessment for its solely owned and jointly owned applicable BES power transformers where the maximum effective GIC value provided in Requirement R9, Part 9.1, is 85 A or greater per phase but did so more than 28 calendar months and less than or equal to 30 calendar months of receiving GIC flow information specified in Requirement R9, Part 9.1;</p> <p>OR</p>	<p>than three of its solely owned and jointly owned applicable BES power transformers (whichever is greater) where the maximum effective GIC value provided in Requirement R9, Part 9.1, is 85 A or greater per phase;</p> <p>OR</p> <p>The responsible entity conducted a supplemental thermal impact assessment for its solely owned and jointly owned applicable BES power transformers where the maximum effective GIC value provided in Requirement R9, Part 9.1, is 85 A or greater per phase but did so more than 30 calendar months of receiving GIC flow information specified in Requirement R9, Part 9.1;</p> <p>OR</p>

R #	Violation Severity Levels			
	Lower VSL	Moderate VSL	High VSL	Severe VSL
		The responsible entity failed to include one of the required elements as listed in Requirement R10, Parts 10.1 through 10.3.	The responsible entity failed to include two of the required elements as listed in Requirement R10, Parts 10.1 through 10.3.	The responsible entity failed to include three of the required elements as listed in Requirement R10, Parts 10.1 through 10.3.
R11.	<p><u>The responsible entity's Corrective Action Plan failed to comply with one of the elements in Requirement R11, Parts 11.1 through 11.5.</u></p> <p>N/A</p>	<p><u>The responsible entity's Corrective Action Plan failed to comply with two of the elements in Requirement R11, Parts 11.1 through 11.5.</u></p> <p>N/A</p>	<p><u>The responsible entity's Corrective Action Plan failed to comply with three of the elements in Requirement R11, Parts 11.1 through 11.5.</u></p> <p>N/A</p>	<p><u>The responsible entity's Corrective Action Plan failed to comply with four or more of the elements in Requirement R11, Parts 11.1 through 11.5;</u></p> <p><u>OR</u></p> <p><u>The responsible entity did not develop a Corrective Action Plan as required by Requirement R11.</u></p> <p>The responsible entity did not implement a process to obtain GIC monitor data from at least one GIC monitor located in the Planning Coordinator's planning area or other part of the system included in the Planning Coordinator's GIC System Model.</p>

R #	Violation Severity Levels			
	Lower VSL	Moderate VSL	High VSL	Severe VSL
R12.	N/A	N/A	N/A	<p><u>The responsible entity did not implement a process to obtain GIC monitor data from at least one GIC monitor located in the Planning Coordinator’s planning area or other part of the system included in the Planning Coordinator’s GIC System Model.</u></p> <p>The responsible entity did not implement a process to obtain geomagnetic field data for its Planning Coordinator’s planning area.</p>
<u>R13.</u>	<u>N/A</u>	<u>N/A</u>	<u>N/A</u>	<p><u>The responsible entity did not implement a process to obtain geomagnetic field data for its Planning Coordinator’s planning area.</u></p>

C.D. Regional Variances

D.A. Regional Variance for Canadian Jurisdictions

This Variance shall be applicable in those Canadian jurisdictions where the Variance has been approved for use by the applicable governmental authority or has otherwise become effective in the jurisdiction.

This variance replaces All references to “Attachment 1” in the standard ~~are replaced~~ with “Attachment 1 or Attachment 1-CAN.”

In addition, this Variance replaces Requirement R7, Part 7.3 through Part 7.5 and Requirement R11, Part 11.3 through Part 11.5 with the following:

D.A.7.3. Include a timetable, subject to revision by the responsible entity in Part D.A.7.4, for implementing the selected actions from Part 7.1. The timetable shall:

D.A.7.3.1. Specify implementation of non-hardware mitigation, if any, within two years of the later of the development of the CAP ~~or~~ receipt of regulatory approvals, if required; and

D.A.7.3.2. Specify implementation of hardware mitigation, if any, within four years of the later of the development of the CAP or receipt of regulatory approvals, if required.

D.A.7.4. Be revised if the responsible entity is unable to implement the CAP within the timetable for implementation provided in Part D.A.7.3. The revised CAP shall document the following:

D.A.7.4.1 Circumstances causing the delay for fully or partially implementing the selected actions in Part 7.1 and how those circumstances are beyond the control of the responsible entity;

D.A.7.4.2 Revisions to the selected actions in Part 7.1, if any, including utilization of Operating Procedures if applicable; and

D.A.7.4.3 Updated timetable for implementing the selected actions in Part 7.1.

D.A.7.5. Be provided: (i) to the responsible entity’s Reliability Coordinator, adjacent Planning Coordinator(s), adjacent Transmission Planner(s), and functional entities referenced in the CAP within 90 calendar days of development or revision, (ii) to any functional entity that submits a written request and has a reliability-related need within 90 calendar days of receipt of such request or within 90 calendar days of development or revision, whichever is later, and (iii) to the Compliance Enforcement Authority or Applicable Governmental Authority when revised under D.A.7.4 within 90 calendar days of revision.

D.A.7.5.1 If a recipient of the CAP provides documented comments on the CAP, the responsible entity shall provide a documented response to that recipient within 90 calendar days of receipt of those comments.

D.A.M.7. Each responsible entity, as determined in Requirement R1, that concludes, through the benchmark GMD Vulnerability Assessment conducted in Requirement R4, that the responsible entity's System does not meet the performance requirements for the steady state planning benchmark GMD event contained in Table 1 shall have evidence such as dated electronic or hard copies of its CAP including timetable for implementing selected actions, as specified in Requirement R7. Each responsible entity, as determined in Requirement R1, shall also provide evidence, such as email records or postal receipts showing recipient and date, that it has revised its CAP if situations beyond the responsible entity's control prevent implementation of the CAP within the timetable specified. Each responsible entity, as determined in Requirement R1, shall also provide evidence, such as email records, web postings with an electronic notice of posting, or postal receipts showing recipient and date, that it has distributed its CAP or relevant information, if any, (i) to the responsible entity's Reliability Coordinator, adjacent Planning Coordinator(s), adjacent Transmission Planner(s), and functional entities referenced in the CAP within 90 calendar days of development or revision, (ii) to any functional entity that submits a written request and has a reliability-related need within 90 calendar days of receipt of such request or within 90 calendar days of development or revision, whichever is later as specified in Requirement R7, and (iii) to the Compliance Enforcement Authority or Applicable Governmental Authority when revised under D.A.7.4 within 90 calendar days of revision. Each responsible entity, as determined in Requirement R1, shall also provide evidence, such as email notices or postal receipts showing recipient and date, that it has provided a documented response to comments received on its CAP within 90 calendar days of receipt of those comments, in accordance with Requirement R7.

D.A.11.3.–Include a timetable, subject to revision by the responsible entity in Part D.A.11.4, for implementing the selected actions from Part 11.1. The timetable shall:

D.A.11.3.1. Specify implementation of non-hardware mitigation, if any, within two years of the later of the development of the CAP or receipt of regulatory approvals, if required; and

D.A.11.3.2. Specify implementation of hardware mitigation, if any, within four years of the later of the development of the CAP or receipt of regulatory approvals, if required.

D.A.11.4. Be revised if the responsible entity is unable to implement the CAP within the timetable for implementation provided in Part D.A.11.3. The revised CAP shall document the following:

D.A.11.4.1 Circumstances causing the delay for fully or partially implementing the selected actions in Part 11.1 and how those circumstances are beyond the control of the responsible entity;

D.A.11.4.2. Revisions to the selected actions in Part 11.1, if any, including utilization of Operating Procedures if applicable; and

D.A.11.4.3. Updated timetable for implementing the selected actions in Part 11.1.

D.A.11.5. Be provided: (i) to the responsible entity's Reliability Coordinator, adjacent Planning Coordinator(s), adjacent Transmission Planner(s), and functional entities referenced in the CAP within 90 calendar days of development or revision, (ii) to any functional entity that submits a written request and has a reliability-related need within 90 calendar days of receipt of such request or within 90 calendar days of development or revision, whichever is later, and (iii) to the Compliance Enforcement Authority or Applicable Governmental Authority when revised under D.A.11.4 within 90 calendar days of revision.

D.A.11.5.1. If a recipient of the CAP provides documented comments on the CAP, the responsible entity shall provide a documented response to that recipient within 90 calendar days of receipt of those comments.

D.A.M.11. Each responsible entity, as determined in Requirement R1, that concludes, through the supplemental GMD Vulnerability Assessment conducted in Requirement R8, that the responsible entity's System does not meet the performance requirements for the steady state planning supplemental GMD event contained in Table 1 shall have evidence such as dated electronic or hard copies of its CAP including timetable for implementing selected actions, as specified in Requirement R11. Each responsible entity, as determined in Requirement R1, shall also provide evidence, such as email records or postal receipts showing recipient and date, that it has revised its CAP if situations beyond the responsible entity's control prevent implementation of the CAP within the timetable specified. Each responsible entity, as determined in Requirement R1, shall also provide evidence, such as email records, web postings with an electronic notice of posting, or postal receipts showing recipient and date, that it has distributed its CAP or relevant information, if any, (i) to the responsible entity's Reliability Coordinator, adjacent Planning Coordinator(s), adjacent Transmission Planner(s), and functional entities referenced in the CAP within 90 calendar days of development or revision, (ii) to any functional entity that submits a written request and has a reliability-related need within 90 calendar days of receipt of such request or within 90 calendar days of development or revision, whichever is later as specified in Requirement R11, and (iii) to the Compliance Enforcement Authority or Applicable Governmental Authority when revised under D.A.11.4 within 90 calendar days of revision. Each responsible entity, as determined in Requirement R1, shall also provide evidence, such as email notices or postal receipts showing recipient and date, that it has provided a documented response to comments received on its CAP within 90 calendar days of receipt of those comments, in accordance with Requirement R11.

D-E. Associated Documents

Attachment 1

Attachment 1-CAN

Version History

Version	Date	Action	Change Tracking
1	December 17, 2014	Adopted by the NERC Board of Trustees	New
2	November 9, 2017	Adopted by the NERC Board of Trustees	Revised to respond to directives in FERC Order No. 830.
2	November 25, 2018	FERC Order issued approving TPL-007-2. Docket No. RM18-8-000	
3	February 7, 2019	Adopted by the NERC Board of Trustees	Canadian Variance
<u>4</u>	<u>TBD</u>	<u>Adopted by the NERC Board of Trustees</u>	<u>Revised to respond to directives in FERC Order. 851</u>

Attachment 1

Calculating Geoelectric Fields for the Benchmark and Supplemental GMD Events

The benchmark GMD event¹ defines the geoelectric field values used to compute GIC flows that are needed to conduct a benchmark GMD Vulnerability Assessment. It is composed of the following elements: (1) a reference peak geoelectric field amplitude of 8 V/km derived from statistical analysis of historical magnetometer data; (2) scaling factors to account for local geomagnetic latitude; (3) scaling factors to account for local earth conductivity; and (4) a reference geomagnetic field time series or waveform to facilitate time-domain analysis of GMD impact on equipment.

The supplemental GMD event is composed of similar elements as described above, except (1) the reference peak geoelectric field amplitude is 12 V/km over a localized area; and (2) the geomagnetic field time series or waveform includes a local enhancement in the waveform.²

The regional geoelectric field peak amplitude used in GMD Vulnerability Assessment, E_{peak} , can be obtained from the reference geoelectric field value of 8 V/km for the benchmark GMD event (1) or 12 V/km for the supplemental GMD event (2) using the following relationships:

$$E_{peak} = 8 \times \alpha \times \beta_b \text{ (V/km)} \quad (1)$$

$$E_{peak} = 12 \times \alpha \times \beta_s \text{ (V/km)} \quad (2)$$

where, α is the scaling factor to account for local geomagnetic latitude, and β is a scaling factor to account for the local earth conductivity structure. Subscripts b and s for the β scaling factor denote association with the benchmark or supplemental GMD events, respectively.

Scaling the Geomagnetic Field

The benchmark and supplemental GMD events are defined for geomagnetic latitude of 60° and must be scaled to account for regional differences based on geomagnetic latitude. Table 2 provides a scaling factor correlating peak geoelectric field to geomagnetic latitude. Alternatively, the scaling factor α is computed with the empirical expression:

$$\alpha = 0.001 \times e^{(0.115 \times L)} \quad (3)$$

where, L is the geomagnetic latitude in degrees and $0.1 \leq \alpha \leq 1$.

¹ The Benchmark Geomagnetic Disturbance Event Description, May 2016 is available on the Related Information webpage for TPL-007-1: http://www.nerc.com/pa/Stand/TPL0071RD/Benchmark_clean_May12_complete.pdf.

² The extent of local enhancements is on the order of 100 km in North-South (latitude) direction but longer in East-West (longitude) direction. The local enhancement in the geomagnetic field occurs over the time period of 2-5 minutes. Additional information is available in the Supplemental Geomagnetic Disturbance Event Description, October 2017 white paper on the Project 2013-03 Geomagnetic Disturbance Mitigation project webpage: <http://www.nerc.com/pa/Stand/Pages/Project-2013-03-Geomagnetic-Disturbance-Mitigation.aspx>.

For large planning areas that cover more than one scaling factor from Table 2, the GMD Vulnerability Assessment should be based on a peak geoelectric field that is:

- calculated by using the most conservative (largest) value for α ; or
- calculated assuming a non-uniform or piecewise uniform geomagnetic field.

Table 2: Geomagnetic Field Scaling Factors for the Benchmark and Supplemental GMD Events	
Geomagnetic Latitude (Degrees)	Scaling Factor1 (α)
≤ 40	0.10
45	0.2
50	0.3
54	0.5
56	0.6
57	0.7
58	0.8
59	0.9
≥ 60	1.0

Scaling the Geoelectric Field

The benchmark GMD event is defined for the reference Quebec earth model described in Table 4. The peak geoelectric field, E_{peak} , used in a GMD Vulnerability Assessment may be obtained by either:

- Calculating the geoelectric field for the ground conductivity in the planning area and the reference geomagnetic field time series scaled according to geomagnetic latitude, using a procedure such as the plane wave method described in the NERC GMD Task Force GIC Application Guide;³ or
- Using the earth conductivity scaling factor β from Table 3 that correlates to the ground conductivity map in Figure 1 or Figure 2. Along with the scaling factor α from equation (3) or Table 2, β is applied to the reference geoelectric field using equation (1 or 2, as applicable) to obtain the regional geoelectric field peak amplitude E_{peak} to be used in GMD Vulnerability Assessments. When a ground conductivity model is not available, the planning entity should use the largest β factor of adjacent physiographic regions or a technically justified value.

³ Available at the NERC GMD Task Force project webpage: [http://www.nerc.com/comm/PC/Pages/Geomagnetic-Disturbance-Task-Force-\(GMDTF\)-2013.aspx](http://www.nerc.com/comm/PC/Pages/Geomagnetic-Disturbance-Task-Force-(GMDTF)-2013.aspx).

The earth models used to calculate Table 3 for the United States were obtained from publicly available information published on the U. S. Geological Survey website.⁴ The models used to calculate Table 3 for Canada were obtained from Natural Resources Canada (NRCan) and reflect the average structure for large regions. A planner can also use specific earth model(s) with documented justification and the reference geomagnetic field time series to calculate the β factor(s) as follows:

$$\beta_b = E/8 \text{ for the benchmark GMD event} \quad (4)$$

$$\beta_s = E/12 \text{ for the supplemental GMD} \quad (5)$$

where, E is the absolute value of peak geoelectric in V/km obtained from the technically justified earth model and the reference geomagnetic field time series.

For large planning areas that span more than one β scaling factor, the most conservative (largest) value for β may be used in determining the peak geoelectric field to obtain conservative results. Alternatively, a planner could perform analysis using a non-uniform or piecewise uniform geoelectric field.

Applying the Localized Peak Geoelectric Field in the Supplemental GMD Event

The peak geoelectric field of the supplemental GMD event occurs in a localized area.⁵ Planners have flexibility to determine how to apply the localized peak geoelectric field over the planning area in performing GIC calculations. Examples of approaches are:

- Apply the peak geoelectric field (12 V/km scaled to the planning area) over the entire planning area;
- Apply a spatially limited (12 V/km scaled to the planning area) peak geoelectric field (e.g., 100 km in North-South latitude direction and 500 km in East-West longitude direction) over a portion(s) of the system, and apply the benchmark GMD event over the rest of the system; or
- Other methods to adjust the benchmark GMD event analysis to account for the localized geoelectric field enhancement of the supplemental GMD event.

⁴ Available at <http://geomag.usgs.gov/conductivity/>.

⁵ See the Supplemental Geomagnetic Disturbance Description white paper located on the Project 2013-03 Geomagnetic Disturbance Mitigation project webpage: <http://www.nerc.com/pa/Stand/Pages/Project-2013-03-Geomagnetic-Disturbance-Mitigation.aspx>.

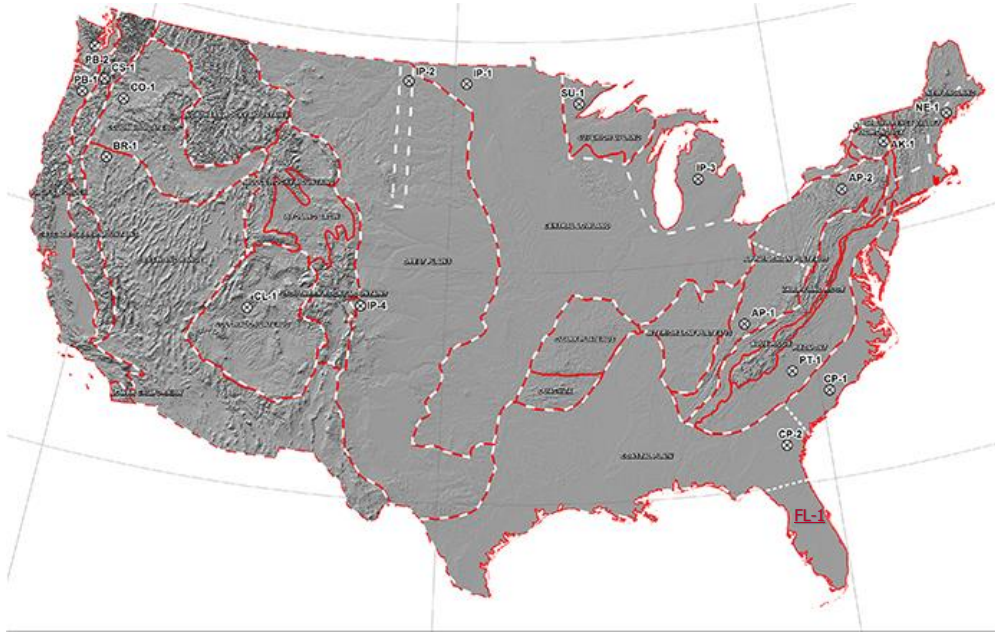

Figure 1: Physiographic Regions of the Continental United States⁶



Figure 2: Physiographic Regions of Canada

⁶ Additional map detail is available at the U.S. Geological Survey: <http://geomag.usgs.gov/>.

Table 3: Geoelectric Field Scaling Factors		
Earth model	Scaling Factor Benchmark Event (β_b)	Scaling Factor Supplemental Event (β_s)
AK1A	0.56	0.51
AK1B	0.56	0.51
AP1	0.33	0.30
AP2	0.82	0.78
BR1	0.22	0.22
CL1	0.76	0.73
CO1	0.27	0.25
CP1	0.81	0.77
CP2	0.95	0.86
FL1	0.76	0.73
CS1	0.41	0.37
IP1	0.94	0.90
IP2	0.28	0.25
IP3	0.93	0.90
IP4	0.41	0.35
NE1	0.81	0.77
PB1	0.62	0.55
PB2	0.46	0.39
PT1	1.17	1.19
SL1	0.53	0.49
SU1	0.93	0.90
BOU	0.28	0.24
FBK	0.56	0.56
PRU	0.21	0.22
BC	0.67	0.62
PRAIRIES	0.96	0.88
SHIELD	1.0	1.0
ATLANTIC	0.79	0.76

Scaling factors in Table 3 are dependent upon the frequency content of the reference storm. Consequently, the benchmark GMD event and the supplemental GMD event may produce different scaling factors for a given earth model.

~~Rationale: Scaling factors in Table 3 are dependent upon the frequency content of the reference storm. Consequently, the benchmark GMD event and the supplemental GMD event may produce different scaling factors for a given earth model.~~

~~The scaling factor associated with the benchmark GMD event for the Florida earth model (FL1) has been updated based on the earth model published on the USGS public website.~~

Layer Thickness (km)	Resistivity (Ω-m)
15	20,000
10	200
125	1,000
200	100
∞	3

Reference Geomagnetic Field Time Series or Waveform for the Benchmark GMD Event⁷

The geomagnetic field measurement record of the March 13-14 1989 GMD event, measured at the NRCan Ottawa geomagnetic observatory, is the basis for the reference geomagnetic field waveform to be used to calculate the GIC time series, GIC(t), required for transformer thermal impact assessment.

The geomagnetic latitude of the Ottawa geomagnetic observatory is 55°; therefore, the amplitudes of the geomagnetic field measurement data were scaled up to the 60° reference geomagnetic latitude (see Figure 3) such that the resulting peak geoelectric field amplitude computed using the reference earth model was 8 V/km (see Figures 4 and 5). The sampling rate for the geomagnetic field waveform is 10 seconds.⁸ To use this geoelectric field time series when a different earth model is applicable, it should be scaled with the appropriate benchmark conductivity scaling factor β_b .

⁷ Refer to the Benchmark Geomagnetic Disturbance Event Description white paper for details on the determination of the reference geomagnetic field waveform: <http://www.nerc.com/pa/stand/Pages/TPL0071RI.aspx>.

⁸ The data file of the benchmark geomagnetic field waveform is available on the Related Information webpage for TPL-007-1: <http://www.nerc.com/pa/stand/Pages/TPL0071RI.aspx>.

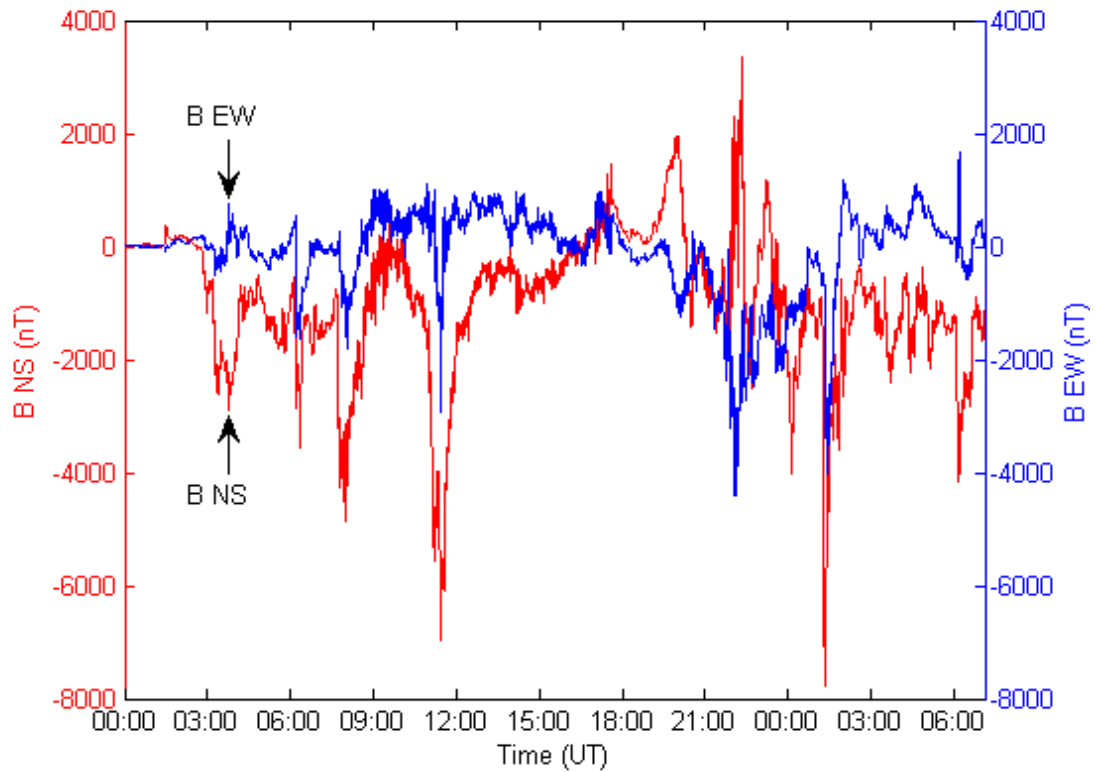

Figure 3: Benchmark Geomagnetic Field Waveform
Red B_n (Northward), Blue B_e (Eastward)

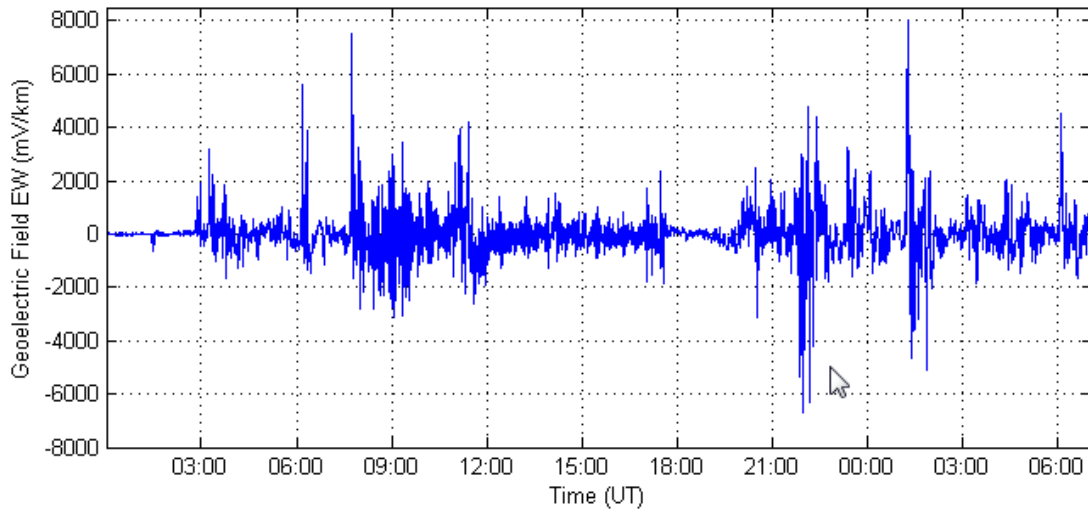
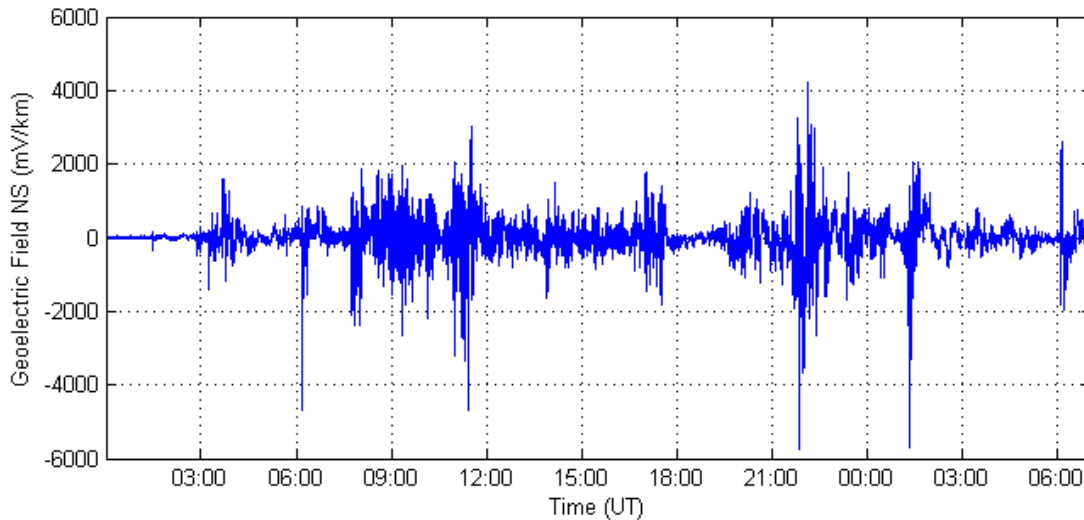

Figure 4: Benchmark Goelectric Field Waveform
E_E (Eastward)



**Figure 5: Benchmark Geoelectric Field Waveform
 E_N (Northward)**

Reference Geomagnetic Field Time Series or Waveform for the Supplemental GMD Event⁹

The geomagnetic field measurement record of the March 13-14, 1989 GMD event, measured at the NRCan Ottawa geomagnetic observatory, is the basis for the reference geomagnetic field waveform to be used to calculate the GIC time series, $GIC(t)$, required for transformer thermal impact assessment for the supplemental GMD event. The supplemental GMD event waveform differs from the benchmark GMD event waveform in that the supplemental GMD event waveform has a local enhancement.

The geomagnetic latitude of the Ottawa geomagnetic observatory is 55° ; therefore, the amplitudes of the geomagnetic field measurement data were scaled up to the 60° reference geomagnetic latitude (see Figure 6) such that the resulting peak geoelectric field amplitude computed using the reference earth model was 12 V/km (see Figure 7). The sampling rate for the geomagnetic field waveform is 10 seconds.¹⁰ To use this geoelectric field time series when a different earth model is applicable, it should be scaled with the appropriate supplemental conductivity scaling factor β_s .

⁹ Refer to the Supplemental Geomagnetic Disturbance Event Description white paper for details on the determination of the reference geomagnetic field waveform: <http://www.nerc.com/pa/Stand/Pages/Project-2013-03-Geomagnetic-Disturbance-Mitigation.aspx>.

¹⁰ The data file of the benchmark geomagnetic field waveform is available on the NERC GMD Task Force project webpage: [http://www.nerc.com/comm/PC/Pages/Geomagnetic-Disturbance-Task-Force-\(GMDTF\)-2013.aspx](http://www.nerc.com/comm/PC/Pages/Geomagnetic-Disturbance-Task-Force-(GMDTF)-2013.aspx).

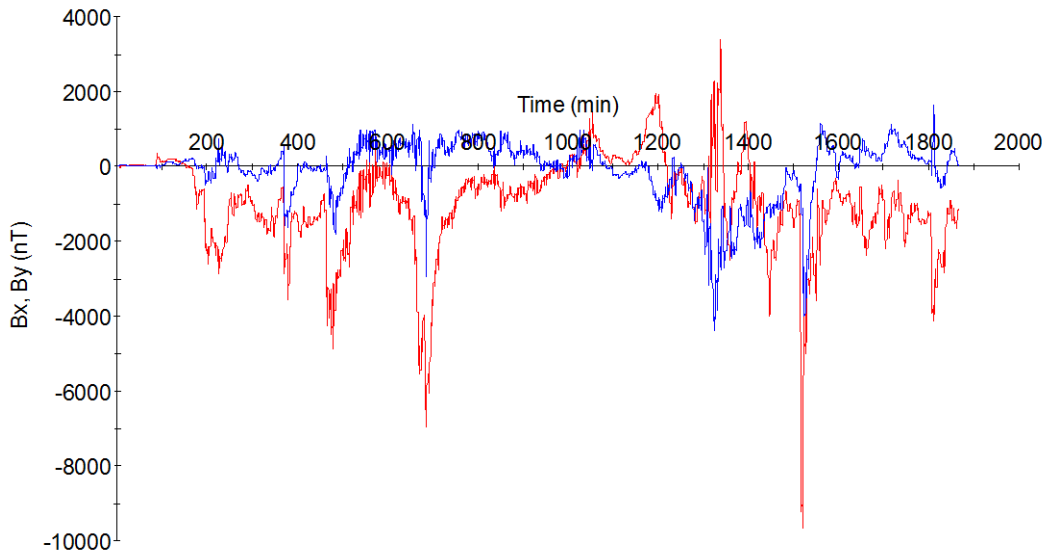

**Figure 6: Supplemental Geomagnetic Field Waveform
Red B_N (Northward), Blue B_E (Eastward)**

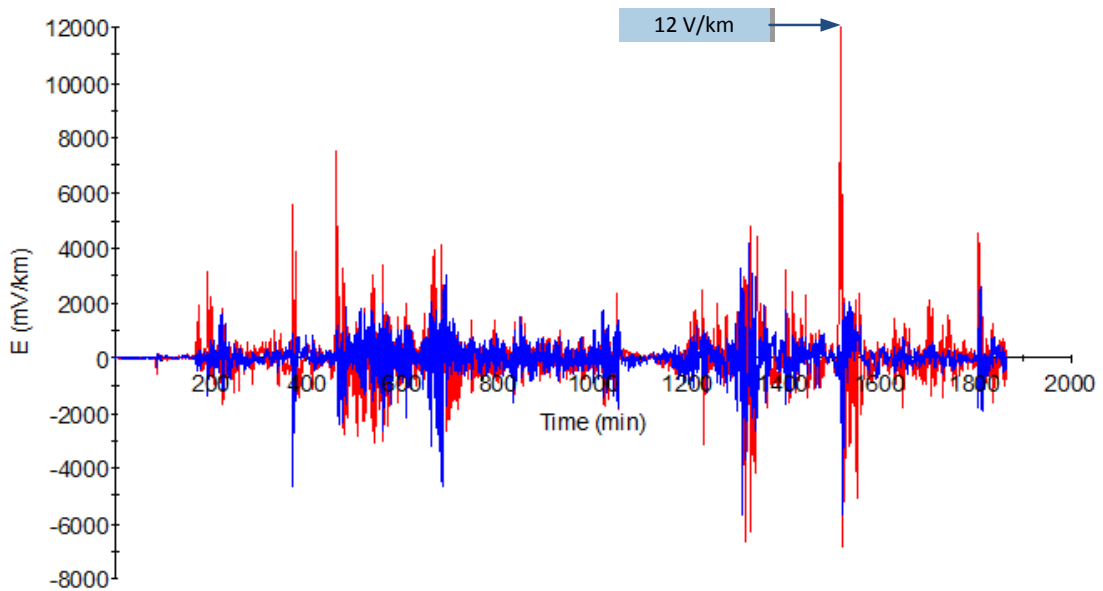

**Figure 7: Supplemental Goelectric Field Waveform
Blue E_N (Northward), Red E_E (Eastward)**

Attachment 1-CAN

Attachment 1-CAN provides an alternative that a Canadian entity may use in lieu of the benchmark or supplemental GMD event(s) defined in Attachment 1 for performing GMD Vulnerability Assessment(s).

A Canadian entity may use the provisions of Attachment 1-CAN if it has regionally specific information that provides a technically justified means to re-define a 1-in-100 year GMD planning event(s) within its planning area.

Information for the Alternative Methodology

GMD Vulnerability Assessment(s) require the use of geophysical and engineering models. Canadian-specific data is available and growing. Ongoing research allows for more accurate characterization of regional parameters used in these models. Such Canadian-specific data includes geomagnetic field, earth conductivity, and geomagnetically induced current measurements that can be used for modeling and simulation validation.

Information used to calculate geoelectric fields for the benchmark and supplemental GMD events shall be clearly documented and technically justified. For example, the factors involved in the calculation of geoelectric fields are geomagnetic field variations and an earth transfer function(s).¹~~14~~ Technically justified information used in modelling geomagnetic field variations may include: technical documents produced by governmental entities such as Natural Resources Canada; technical papers published in peer-reviewed journals; and data sets gathered using sound scientific principles. An earth transfer function may rely on magnetotelluric measurements or earth conductivity models.

Modeling assumptions shall also be clearly documented and technically justified. An entity may use sensitivity analysis to identify how the assumptions affect the results.

A simplified model may be used to perform a GMD Vulnerability Assessment(s), as long as the model is more conservative than a more detailed model.

When interpreting assessment results, the entity shall consider the maturity of the modeling, toolset, and techniques applied.

Geomagnetic Disturbance Planning Events

The 1-in-100 year planning event shall be based on regionally specific data and technically justifiable statistical analyses (e.g., extreme value theory) and applied to the benchmark and supplemental GMD Vulnerability Assessment(s).

¹ The “earth transfer function” is the relationship between the electric fields and magnetic field variations at the surface of the earth.

~~¹⁴ The “earth transfer function” is the relationship between the electric fields and magnetic field variations at the surface of the earth.~~

For the benchmark GMD Vulnerability Assessment(s), an entity shall consider the large-scale spatial structure of the GMD event. For the supplemental GMD Vulnerability Assessment(s), an entity shall consider the small-scale spatial structure of the GMD event (e.g., using magnetometer measurements or realistic electrojet calculations).

Guidelines and Technical Basis

The diagram below provides an overall view of the GMD Vulnerability Assessment process:

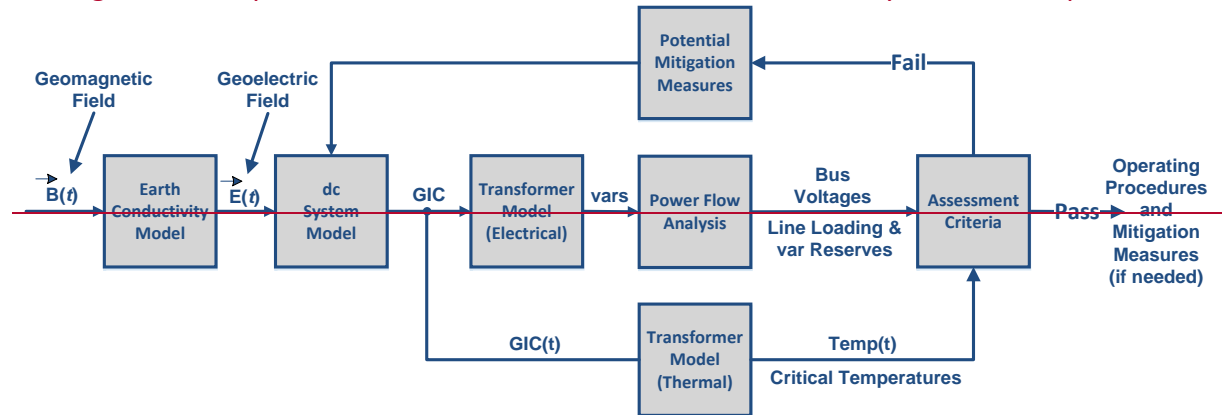

The requirements in this standard cover various aspects of the GMD Vulnerability Assessment process:

Benchmark GMD Event (Attachment 1)

The benchmark GMD event defines the goelectric field values used to compute GIC flows that are needed to conduct a benchmark GMD Vulnerability Assessment. The *Benchmark Geomagnetic Disturbance Event Description, May 2016*⁴¹ white paper includes the event description, analysis, and example calculations.

Supplemental GMD Event (Attachment 1)

The supplemental GMD event defines the goelectric field values used to compute GIC flows that are needed to conduct a supplemental GMD Vulnerability Assessment. The *Supplemental Geomagnetic Disturbance Event Description, October 2017*⁴² white paper includes the event description and analysis.

Requirement R2

A GMD Vulnerability Assessment requires a GIC System model, which is a dc representation of the System, to calculate GIC flow. In a GMD Vulnerability Assessment, GIC simulations are used to determine transformer Reactive Power absorption and transformer thermal response. Details for developing the GIC System model are provided in the NERC GMD Task Force guide:

⁴¹ <http://www.nerc.com/pa/stand/Pages/TPL0071RI.aspx>

⁴² http://www.nerc.com/pa/Stand/Pages/Project_2013_03_Geomagnetic_Disturbance_Mitigation.aspx

~~Application Guide for Computing Geomagnetically-Induced Current in the Bulk Power System, December 2013.~~¹³

~~Underground pipe type cables present a special modeling situation in that the steel pipe that encloses the power conductors significantly reduces the geoelectric field induced into the conductors themselves, while they remain a path for GIC. Solid dielectric cables that are not enclosed by a steel pipe will not experience a reduction in the induced geoelectric field. A planning entity should account for special modeling situations in the GIC system model, if applicable.~~

Requirement R4

~~The *Geomagnetic Disturbance Planning Guide*,¹⁴ December 2013 developed by the NERC GMD Task Force provides technical information on GMD-specific considerations for planning studies.~~

Requirement R5

~~The benchmark thermal impact assessment of transformers specified in Requirement R6 is based on GIC information for the benchmark GMD Event. This GIC information is determined by the planning entity through simulation of the GIC System model and must be provided to the entity responsible for conducting the thermal impact assessment. GIC information should be provided in accordance with Requirement R5 each time the GMD Vulnerability Assessment is performed since, by definition, the GMD Vulnerability Assessment includes a documented evaluation of susceptibility to localized equipment damage due to GMD.~~

~~The maximum effective GIC value provided in Part 5.1 is used for the benchmark thermal impact assessment. Only those transformers that experience an effective GIC value of 75 A or greater per phase require evaluation in Requirement R6.~~

~~GIC(t) provided in Part 5.2 is used to convert the steady state GIC flows to time series GIC data for the benchmark thermal impact assessment of transformers. This information may be needed by one or more of the methods for performing a benchmark thermal impact~~

¹³ ~~http://www.nerc.com/comm/PC/Geomagnetic%20Disturbance%20Task%20Force%20GMDTF%202013/GIC%20Application%20Guide%202013_approved.pdf~~

¹⁴ ~~http://www.nerc.com/comm/PC/Geomagnetic%20Disturbance%20Task%20Force%20GMDTF%202013/GMD%20Planning%20Guide_approved.pdf~~

assessment. Additional information is in the following section and the *Transformer Thermal Impact Assessment White Paper*,¹⁵ October 2017.

The peak GIC value of 75 Amps per phase has been shown through thermal modeling to be a conservative threshold below which the risk of exceeding known temperature limits established by technical organizations is low.

Requirement R6

The benchmark thermal impact assessment of a power transformer may be based on manufacturer provided GIC capability curves, thermal response simulation, thermal impact screening, or other technically justified means. Approaches for conducting the assessment are presented in the *Transformer Thermal Impact Assessment White Paper ERO Enterprise-Endorsed Implementation Guidance*¹⁶ for this requirement. This ERO-Endorsed document is posted on the NERC Compliance Guidance¹⁷ webpage.

Transformers are exempt from the benchmark thermal impact assessment requirement if the effective GIC value for the transformer is less than 75 A per phase, as determined by a GIC analysis of the System. Justification for this criterion is provided in the *Screening Criterion for Transformer Thermal Impact Assessment White Paper*,¹⁸ October 2017. A documented design specification exceeding this value is also a justifiable threshold criterion that exempts a transformer from Requirement R6.

The benchmark threshold criteria and its associated transformer thermal impact must be evaluated on the basis of effective GIC. Refer to the white papers for additional information.

Requirement R7

Technical considerations for GMD mitigation planning, including operating and equipment strategies, are available in Chapter 5 of the *Geomagnetic Disturbance Planning Guide*,¹⁹ December 2013. Additional information is available in the *2012 Special Reliability Assessment*

¹⁵ <http://www.nerc.com/pa/Stand/Pages/Project-2013-03-Geomagnetic-Disturbance-Mitigation.aspx>.

¹⁶ <http://www.nerc.com/pa/comp/guidance/EROEndorsedImplementationGuidance/TPL-007-1-Transformer-Thermal-Impact-Assessment-White-Paper.pdf>.

¹⁷ <http://www.nerc.com/pa/comp/guidance/Pages/default.aspx>.

¹⁸ <http://www.nerc.com/pa/Stand/Pages/Project-2013-03-Geomagnetic-Disturbance-Mitigation.aspx>.

¹⁹ <http://www.nerc.com/comm/PC/Geomagnetic%20Disturbance%20Task%20Force%20GMDTF%202013/GMD%20Planning%20Guide-approved.pdf>.

~~Interim Report: Effects of Geomagnetic Disturbances on the Bulk Power System,~~²⁰ February 2012.

Requirement R8

~~The *Geomagnetic Disturbance Planning Guide*,²¹ December 2013 developed by the NERC GMD Task Force provides technical information on GMD-specific considerations for planning studies.~~

~~The supplemental GMD Vulnerability Assessment process is similar to the benchmark GMD Vulnerability Assessment process described under Requirement R4.~~

Requirement R9

~~The supplemental thermal impact assessment specified of transformers in Requirement R10 is based on GIC information for the supplemental GMD Event. This GIC information is determined by the planning entity through simulation of the GIC System model and must be provided to the entity responsible for conducting the thermal impact assessment. GIC information should be provided in accordance with Requirement R9 each time the GMD Vulnerability Assessment is performed since, by definition, the GMD Vulnerability Assessment includes a documented evaluation of susceptibility to localized equipment damage due to GMD.~~

~~The maximum effective GIC value provided in Part 9.1 is used for the supplemental thermal impact assessment. Only those transformers that experience an effective GIC value of 85 A or greater per phase require evaluation in Requirement R10.~~

~~GIC(t) provided in Part 9.2 is used to convert the steady state GIC flows to time-series GIC data for the supplemental thermal impact assessment of transformers. This information may be needed by one or more of the methods for performing a supplemental thermal impact assessment. Additional information is in the following section.~~

~~The peak GIC value of 85 Amps per phase has been shown through thermal modeling to be a conservative threshold below which the risk of exceeding known temperature limits established by technical organizations is low.~~

Requirement R10

~~The supplemental thermal impact assessment of a power transformer may be based on manufacturer provided GIC capability curves, thermal response simulation, thermal impact screening, or other technically justified means. Approaches for conducting the assessment are presented in the *Transformer Thermal Impact Assessment White Paper ERO Enterprise-Endorsed Implementation Guidance*²² discussed in the Requirement R6 section above. A later~~

²⁰ <http://www.nerc.com/pa/RAPA/ra/Reliability%20Assessments%20DL/2012GMD.pdf>.

²¹ http://www.nerc.com/comm/PC/Geomagnetic%20Disturbance%20Task%20Force%20GMDTF%202013/GMD%20Planning%20Guide_approved.pdf.

²² http://www.nerc.com/pa/comp/guidance/EROEndorsedImplementationGuidance/TPL-007-1_Transformer_Thermal_Impact_Assessment_White_Paper.pdf.

~~version of the *Transformer Thermal Impact Assessment White Paper*,²³ October 2017, has been developed to include updated information pertinent to the supplemental GMD event and supplemental thermal impact assessment.~~

~~Transformers are exempt from the supplemental thermal impact assessment requirement if the effective GIC value for the transformer is less than 85 A per phase, as determined by a GIC analysis of the System. Justification for this criterion is provided in the revised *Screening Criterion for Transformer Thermal Impact Assessment White Paper*,²⁴ October 2017. A documented design specification exceeding this value is also a justifiable threshold criterion that exempts a transformer from Requirement R10.~~

~~The supplemental threshold criteria and its associated transformer thermal impact must be evaluated on the basis of effective GIC. Refer to the white papers for additional information.~~

Requirement R11

~~Technical considerations for GIC monitoring are contained in Chapter 6 of the *2012 Special Reliability Assessment Interim Report: Effects of Geomagnetic Disturbances on the Bulk Power System*,²⁵ February 2012. GIC monitoring is generally performed by Hall effect transducers that are attached to the neutral of the wye-grounded transformer. Data from GIC monitors is useful for model validation and situational awareness.~~

~~Responsible entities consider the following in developing a process for obtaining GIC monitor data:~~

~~**Monitor locations.** An entity's operating process may be constrained by location of existing GIC monitors. However, when planning for additional GIC monitoring installations consider that data from monitors located in areas found to have high GIC based on system studies may provide more useful information for validation and situational awareness purposes. Conversely, data from GIC monitors that are located in the vicinity of transportation systems using direct current (e.g., subways or light rail) may be unreliable.~~

~~**Monitor specifications.** Capabilities of Hall effect transducers, existing and planned, should be considered in the operating process. When planning new GIC monitor installations, consider~~

²³ http://www.nerc.com/pa/Stand/Pages/Project_2013_03_Geomagnetic_Disturbance_Mitigation.aspx.

²⁴ http://www.nerc.com/pa/Stand/Pages/Project_2013_03_Geomagnetic_Disturbance_Mitigation.aspx.

²⁵ <http://www.nerc.com/pa/RAPA/ra/Reliability%20Assessments%20DL/2012GMD.pdf>.

monitor data range (e.g., -500 A through +500 A) and ambient temperature ratings consistent with temperatures in the region in which the monitor will be installed.

Sampling Interval. An entity's operating process may be constrained by capabilities of existing GIC monitors. However, when possible specify data sampling during periods of interest at a rate of 10 seconds or faster.

Collection Periods. The process should specify when the entity expects GIC data to be collected. For example, collection could be required during periods where the Kp index is above a threshold, or when GIC values are above a threshold. Determining when to discontinue collecting GIC data should also be specified to maintain consistency in data collection.

Data format. Specify time and value formats. For example, Greenwich Mean Time (GMT) (MM/DD/YYYY HH:MM:SS) and GIC Value (Ampere). Positive (+) and negative (-) signs indicate direction of GIC flow. Positive reference is flow from ground into transformer neutral. Time

fields should indicate the sampled time rather than system or SCADA time if supported by the GIC monitor system.

Data retention. The entity's process should specify data retention periods, for example 1 year. Data retention periods should be adequately long to support availability for the entity's model validation process and external reporting requirements, if any.

Additional information. The entity's process should specify collection of other information necessary for making the data useful, for example monitor location and type of neutral connection (e.g., three phase or single phase).

Requirement R12

Magnetometers measure changes in the earth's magnetic field. Entities should obtain data from the nearest accessible magnetometer. Sources of magnetometer data include:

Observatories such as those operated by U.S. Geological Survey and Natural Resources Canada, see figure below for locations:²⁶

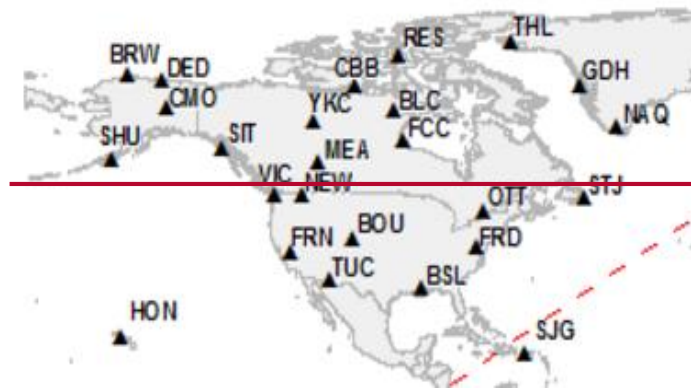

²⁶ http://www.intermagnet.org/index_eng.php.