

NERC

NORTH AMERICAN ELECTRIC
RELIABILITY CORPORATION

900 MW Fault Induced Solar Photovoltaic Resource Interruption Disturbance Report

Southern California Event: October 9, 2017
Joint NERC and WECC Staff Report

February 2018

RELIABILITY | ACCOUNTABILITY



3353 Peachtree Road NE
Suite 600, North Tower
Atlanta, GA 30326
404-446-2560 | www.nerc.com

Table of Contents

Preface.....	iii
Executive Summary	iv
Key Findings, Actions, and Recommendations.....	iv
Chapter 1: Event Summary.....	1
Chapter 2: Analysis of Inverter-Based Resource Performance	7
No Erroneous Frequency Tripping	7
Continued Use of Momentary Cessation.....	8
Ramp Rate Interactions with Recovery from Momentary Cessation	9
Interpretation of PRC-024-2 Voltage Ride-Through Curve	11
Instantaneous Voltage Tripping.....	13
Phase Lock Loop Synchronization Issues	15
DC Reverse Current Tripping	16
Intra-Plant Transient Interactions and Ride-Through Considerations.....	17
Chapter 3: Findings, Actions, and Recommendations.....	19
Finding 1: No Erroneous Frequency Tripping	19
Finding 2: Continued Use of Momentary Cessation	19
Finding 3: Ramp Rate Interactions with Momentary Cessation	19
Finding 4: Interpretation of PRC-024-2 Voltage Ride-Through Curve	20
Finding 5: Instantaneous Voltage Tripping and Measurement Filtering	20
Finding 6: Phase Lock Loop Synchronization Issues	20
Finding 7: DC Reverse Current Tripping.....	20
Finding 8: Transient Interactions and Ride-Through Considerations	21
Additional Recommendations	21
Appendix A: Glossary of Terms and Acronyms.....	22
Appendix B: October 9, 2017 Disturbance Analysis Team	23

Preface

The North American Electric Reliability Corporation (NERC) is a not-for-profit international regulatory authority whose mission is to assure the reliability of the bulk power system (BPS) in North America. NERC develops and enforces Reliability Standards; annually assesses seasonal and long-term reliability; monitors the BPS through system awareness; and educates, trains, and certifies industry personnel. NERC’s area of responsibility spans the continental United States, Canada, and the northern portion of Baja California, Mexico. NERC is the electric reliability organization (ERO) for North America, subject to oversight by the Federal Energy Regulatory Commission (FERC) and governmental authorities in Canada. NERC’s jurisdiction includes users, owners, and operators of the BPS, which serves more than 334 million people.

The North American BPS is divided into the eight Regional Entity (RE) boundaries, as shown in the map and corresponding table below.

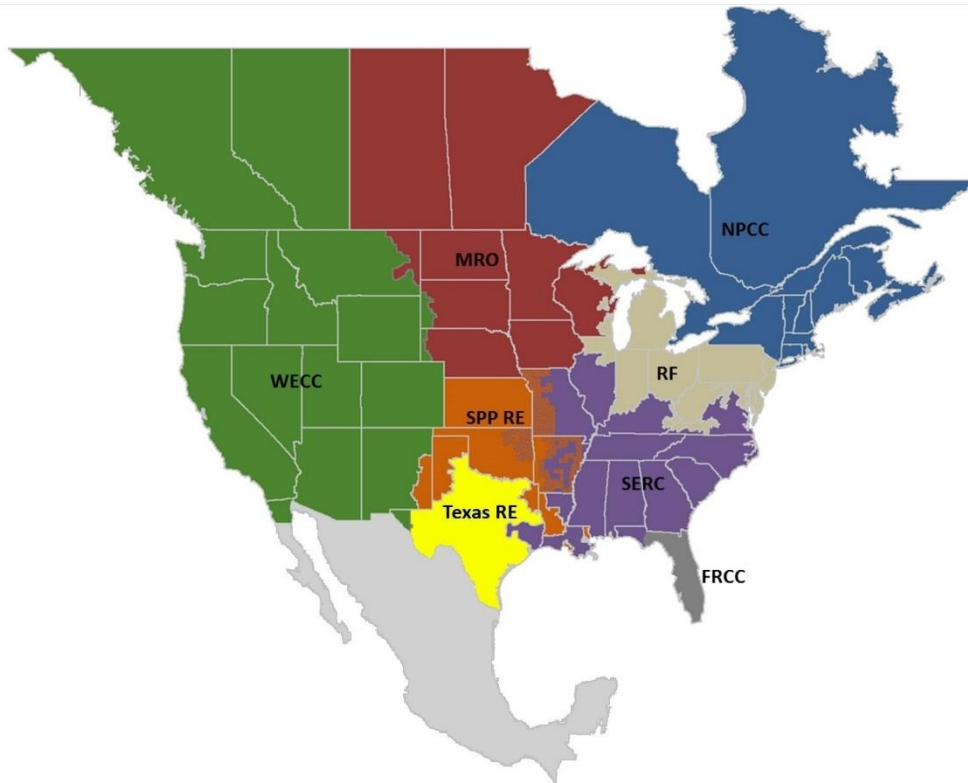

The Regional boundaries in this map are approximate. The highlighted area between SPP and SERC denotes overlap as some load-serving entities participate in one Region while associated transmission owners/operators participate in another.

FRCC	Florida Reliability Coordinating Council
MRO	Midwest Reliability Organization
NPCC	Northeast Power Coordinating Council
RF	Reliability First
SERC	SERC Reliability Corporation
SPP RE	Southwest Power Pool Regional Entity
Texas RE	Texas Reliability Entity
WECC	Western Electricity Coordinating Council

Executive Summary

This report contains the ERO analysis of the BPS disturbance that occurred in the Southern California area on October 9, 2017, resulting from the Canyon 2 Fire. This report was prepared following the data request to Generator Owners (GOs) and Generator Operators (GOPs) sent on October 12, 2017, after the event was identified by NERC, WECC, and Southern California Edison (SCE). The purpose of the report is to document the analysis, key findings, and recommendations from the Canyon 2 Fire disturbance.

On October 9, 2017, the Canyon 2 Fire caused two transmission system faults near the Serrano substation east of Los Angeles. The first fault was a normally cleared phase-to-phase fault on a 220 kV transmission line that occurred at 12:12:16 Pacific time, and the second fault was a normally cleared phase-to-phase fault on a 500 kV transmission line that occurred at 12:14:30 Pacific time. Both faults resulted in the reduction of solar PV generation across a wide region of the SCE footprint. Approximately 900 MW of solar PV resources were lost as a result of these events,¹ and six solar PV plants accounted for most of the reduction in generation. In general, the majority of inverter tripping was caused by sub-cycle transient overvoltages and instantaneous protective action at the inverters to disconnect them from the grid. A significant amount of inverters also entered momentary cessation during and following the fault events.

NERC and WECC developed a data request to gather information related to the performance of affected generating facilities. The information was collected and analyzed by NERC and WECC in coordination with the affected GOPs and inverter manufacturers.

Key Findings, Actions, and Recommendations

The following are key findings, actions, and recommendations for inverter-based resource performance as a direct outcome of the analysis of the October 9, 2017, Canyon 2 Fire disturbance:

- **Finding 1: No Erroneous Frequency Tripping**
No inverter-based resources tripped due to frequency-related protective functions. Affected inverter manufacturers and GOs immediately responded to the recommendations from the Blue Cut Fire disturbance report² to address the issues of erroneous tripping due to miscalculated frequency during transient conditions. Erroneous tripping due to miscalculated frequency appears to be remediated.
- **Finding 2: Continued Use of Momentary Cessation**
Solar PV resources continue to use momentary cessation³ most commonly for voltage magnitudes outside 0.9–1.1 per unit (pu). The use of momentary cessation is observed in sequence of events recording and high resolution measurement data.

Action 2

The NERC Inverter-Based Resource Task Force (IRPTF) is performing stability studies for the Western Interconnection to more thoroughly investigate the potential implications of momentary cessation on system stability. The IRPTF is developing performance recommendations for use of momentary cessation only where existing resources may need to use it due to equipment limitations. NERC is also inventorying momentary cessation for existing inverters based on manufacturer and model to understand its breadth of use and potential mitigation.

¹ No solar PV generation was de-energized as a direct consequence of the fault event; rather, the facilities ceased output as a response to the fault on the system.

² The Blue Cut Fire disturbance report can be found here:

http://www.nerc.com/pa/rrm/ea/1200_MW_Fault_Induced_Solar_Photovoltaic_Resource_/1200_MW_Fault_Induced_Solar_Photovoltaic_Resource_Interruption_Final.pdf.

³ Momentary cessation is an operating mode used by inverters where they momentarily cease current injection into the grid when voltages fall outside predetermined threshold values (most commonly above 1.1 pu or below 0.9 pu voltage).

Recommendation 2

The use of momentary cessation is not recommended, should not be used for new inverter-based resources, and should be eliminated or mitigated to the greatest extent possible for existing resources connected to the BPS. For existing resources that must use momentary cessation as an equipment limitation, active current injection following voltage recovery should be restored very quickly (i.e., within 0.5 seconds). The NERC IRPTF should develop recommendations as to whether any conditions warrant the use of momentary cessation and perform dynamic simulations to understand the impacts of momentary cessation on BPS stability.

- **Finding 3: Ramp Rate Interactions with Momentary Cessation**

Inverter-based resources are returning to predisturbance outputs slower than desired because plant-level controller ramp rate limits used for balancing generation and load are being applied to inverter-based resources following momentary cessation. During ride-through conditions, the inverter controls its output and ignores signals sent by the plant-level controller. After voltage recovers and the inverter enters a normal operating range, it again responds to signals from the plant controller. The plant controller then applies its ramp rate limits to the remaining recovery of current injections restraining the inverter from recovering quickly to its predisturbance current injection.

Recommendation 3

Existing inverters where momentary cessation cannot be effectively eliminated should not be impeded from restoring current injection following momentary cessation. Active current injection should not be restricted by a plant-level controller or other slow ramp rate limits. Resources with this interaction should remediate the issue in close coordination with their Balancing Authority (BA) and inverter manufacturers; this is to ensure that ramp rates are still enabled appropriately to control gen-load balance but not applied to restoring output following momentary cessation. Plant controllers may consider including a short delay (i.e., 0.5 seconds) before sending commands following ride-through mode to ensure the inverter has fully recovered active current injection before resuming control.

- **Finding 4: Interpretation of PRC-024-2 Voltage Ride-Through Curve**

Many inverters currently installed on the BPS are set to trip when outside of the PRC-024-2 voltage ride-through curve. The curve is often used as the inverter protective trip settings rather than setting the protection to the widest extent possible while still protecting the equipment. The region outside of the PRC-024-2 voltage ride-through curve is being misinterpreted as a “must trip” region rather than a “may trip” region.

Action 4⁴

NERC Event Analysis is developing a NERC Alert⁵ that will be issued to the industry to ensure that the intent of the PRC-024-2 curve and equipment voltage protective philosophies are understood. The purpose of the NERC Alert is to inform GOs of voltage-related inverter tripping risks during grid disturbances and to ensure that GOs understand the steps that can be taken to mitigate these risks.

Recommendation 4

Voltage protection functions in the inverters should be set based on physical equipment limitations to protect the inverter itself and not based solely on the PRC-024-2 voltage ride-through characteristic. Within the “no trip” region of the curve, the inverters are expected to ride through and continue injecting current to the BPS. The region outside the curve should be interpreted as a “may trip” zone and not a “must trip” zone and protection should be set as wide as possible while still ensuring the reliability and integrity of the inverter-based resource.

⁴ This action also relates to the Finding 5, which pertains to voltage protective relaying in inverters.

⁵ NERC Alerts: <http://www.nerc.com/pa/rrm/bpsa/Pages/About-Alerts.aspx>

- **Finding 5: Instantaneous Voltage Tripping and Measurement Filtering**

A large percentage of existing inverters on the BPS are configured to trip using instantaneous overvoltage protection, based on the PRC-024-2 high voltage ride-through curve, and do not filter out voltage transients. Any instantaneous, sub-cycle transient overvoltage may trip the inverter off-line making these resources susceptible to tripping on transients caused by faults and other switching actions.

Recommendation 5

Inverter protective functions should use a filtered, fundamental frequency voltage input for overvoltage protection when compared with the PRC-024-2 ride-through curve.

- **Finding 6: Phase Lock Loop Synchronization Issues**

One inverter manufacturer reported fault codes for phase lock loop (PLL) synchronization issues that resulted in protective action to open the inverter primary circuit breaker.

Recommendation 6

Inverters should not trip for momentary PLL loss of synchronism caused by phase jumps, distortion, etc., during BPS grid events (e.g., faults). Inverters should continue to inject current into the grid and, at a minimum, lock the PLL to the last synchronized point and continue injecting current to the BPS at that calculated phase until the PLL can regain synchronism upon fault clearing.

- **Finding 7: DC Reverse Current Tripping**

One inverter manufacturer reported fault codes for dc reverse current, where protective action opened the inverter primary circuit breaker. The dc reverse current caused the resources to remain off-line for an average of 81 minutes after tripping because this is considered a “major fault” that requires a manual reset at the inverter.

Recommendation 7

GOs should coordinate with their inverter manufacturers to ensure that dc reverse current detection and protection are set to avoid tripping for dc reverse currents that could result during sub-cycle transient overvoltage conditions since these are not likely to damage any equipment in the plant. Mitigating steps may include increasing the magnitude settings to align with the ratings of the equipment or implementing a short duration to the dc reverse current protection before sending the trip command.

- **Finding 8: Transient Interactions and Ride-Through Considerations**

There appears to be an inter-relationship between in-plant shunt compensation, sub-cycle transient overvoltage, and momentary cessation that results in inverter tripping. While this has been observed at multiple locations for multiple events, the causes and effects are not well understood and require detailed electromagnetic transient (EMT) simulations for further investigation.

Recommendation 8

EMT studies should be performed by the affected GOPs, in coordination with their Transmission Owner(s) (TO(s)), to better understand the cause of transient overvoltages resulting in inverter tripping. These studies should also identify why the observed inverter terminal voltages are much higher than the voltage at the point of measurement (POM) and any protection coordination needed to ride through these types of voltage conditions.

Additional Recommendations:

- A NERC Alert should be issued to the NERC registered GOs to ensure that they understand the intent of the PRC-024-2 curve and equipment voltage protective philosophies. The purpose of the NERC Alert is to mitigate unnecessary voltage-related inverter tripping during grid disturbances and to ensure that GOs understand how to mitigate these risks.
- Generic dynamic stability models, used during the interconnection process for studying reliability of the BPS, do not accurately reflect all aspects of the behavior of inverter-based resources. Model

improvements should be prioritized by industry groups developing these models (e.g., WECC Renewable Energy Modeling Task Force) to ensure that stability models sufficiently reflect the behavior of inverter-based resources installed today and in the future.

- Continued analyses of inverter-based resource performance under existing and future penetration levels are needed to determine if there are any reliability risks using control philosophies employed today. The ERO Enterprise and affected BAs should determine if potential resource loss events caused by momentary cessation or inverter tripping could pose a reliability risk.
- NERC and the NERC IRPTF should continue monitoring and analyzing grid events that involve inverter-based resources. Regional Entities should continue issuing data requests to GOs and GOPs when events indicate losses of inverter-based resources. Information collected from data requests, and follow-up discussions with inverter manufacturers and affected GOs and GOPs, significantly improves industry understanding of the performance characteristics of inverters connected to the BPS. The NERC IRPTF should include findings from this Disturbance Report and the Blue Cut Fire Disturbance Report in the Reliability Guideline that is being developed. NERC plans to publish the Reliability Guideline around September 2018.

Data and information about the event were gathered from the affected registered entities involved in the disturbance, and this was instrumental to the successful and timely completion of this analysis.

Chapter 1: Event Summary

On October 9, 2017, the Canyon 2 Fire caused two transmission system faults near Anaheim Hills, California, which is approximately 30 miles east of Los Angeles. The first fault was a normally cleared phase-to-phase fault on a 220 kV transmission line that occurred at 12:12:16 Pacific time, and the second fault was a normally cleared phase-to-phase fault on a 500 kV transmission line that occurred at 12:14:30 Pacific time. Both faults resulted in the reduction of solar PV generation across a wide region of the Southern California Edison (SCE) footprint. Figure 1.1 shows a high-level map of the affected areas of solar PV generation and the location of the Canyon 2 Fire. The two values correspond to the amounts of solar PV power reduction during the first and second fault events.

The first fault resulted in a reduction of 682 MW of solar PV resources, and the second fault resulted in a reduction of 937 MW. These amounts were determined using supervisory control and data acquisition (SCADA) data supplied by SCE at a resolution of one sample every four seconds. Data of this resolution is able to capture the general response of the solar PV plants over a longer period of time; however, the data cannot differentiate between momentary cessation and tripping in some cases.⁶ Based on data requested for this event (e.g., sequence of events alarms, high resolution measurements, etc.) from Generator Owners (GOs) and Generator Operators (GOPs) for this event, it was confirmed that most of the affected solar PV inverters that did not trip entered momentary cessation. Some plants restored output within five seconds, as recommended in the Blue Cut Fire disturbance report, while others took longer to fully restore power output.



Figure 1.1: Map of the Affected Area and Canyon 2 Fire Location⁷

⁶ MW loss values in this report are based on SCADA measurements, which do not capture momentary cessation and restoration of current injection immediately following momentary cessation in sufficient resolution since momentary cessation and current restoration are often faster than SCADA scan rates. Therefore, reported MW loss values relate mostly to tripping and not to momentary cessation. Additionally, there could be additional BPS disturbances that are overlooked because SCADA may not capture the momentary loss for that event.

⁷ The active power loss values for each event were derived from SCADA data used in the aggregated solar PV response that is shown in Figure 1.4.

Figures 1.2 and 1.3 show digital fault recorder (DFR) point-on-wave data from the fault locations⁸ and demonstrate that both the 220 kV and 500 kV phase-to-phase faults cleared normally with no irregular transient behavior. Both faults resulted in tripping or momentary reduction of a significant amount of solar PV resources affected by these faults. No solar PV generation was de-energized as a direct consequence of the protective relaying removing the faulted element(s) from service; rather, the solar PV inverter controls tripped in response to the measured conditions at their point of measurement (POM) or terminals.

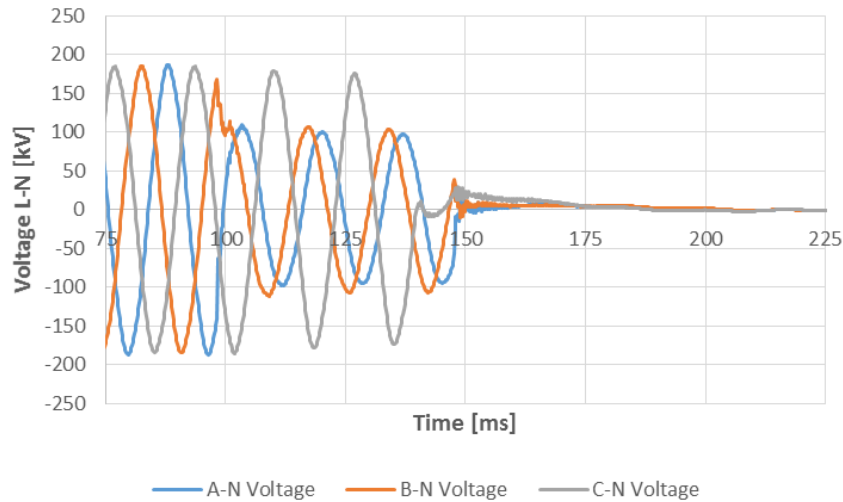

Figure 1.2: DFR Data from 220 kV A-B Phase Fault at 12:12:16 PST [Source: SCE]

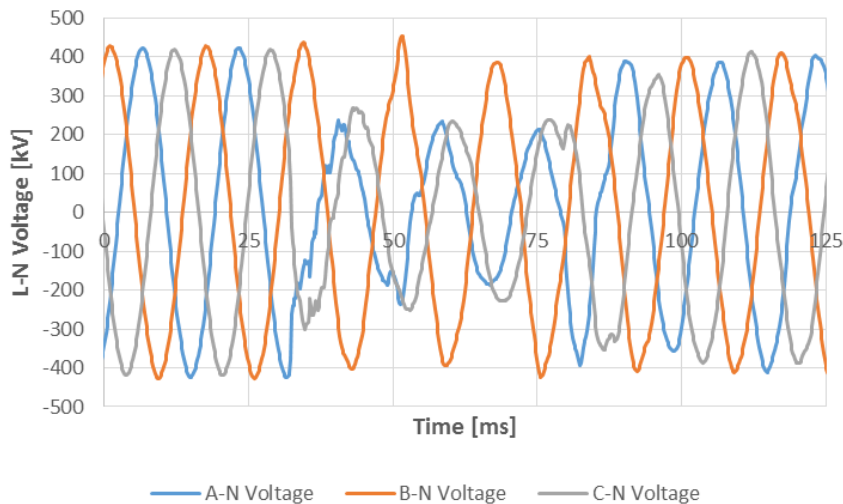

Figure 1.3: DFR Data from 500 kV A-C Phase Fault at 12:14:30 PST [Source: SCE]

Figure 1.4 shows the aggregate solar PV fleet response during the two events, Figure 1.5 shows the aggregated response of solar PV resources separated by region (to match Figure 1.1), and Figure 1.6 shows the response of the six solar PV plants that accounted for most of the reduction in generation. These plots were generated using SCADA data from Southern California Edison.

⁸ The 220 kV measurement is on the line side, hence why measured voltage goes to zero upon fault clearing. The 500 kV measurement is on the bus side and measured voltage recovers after fault clearing.

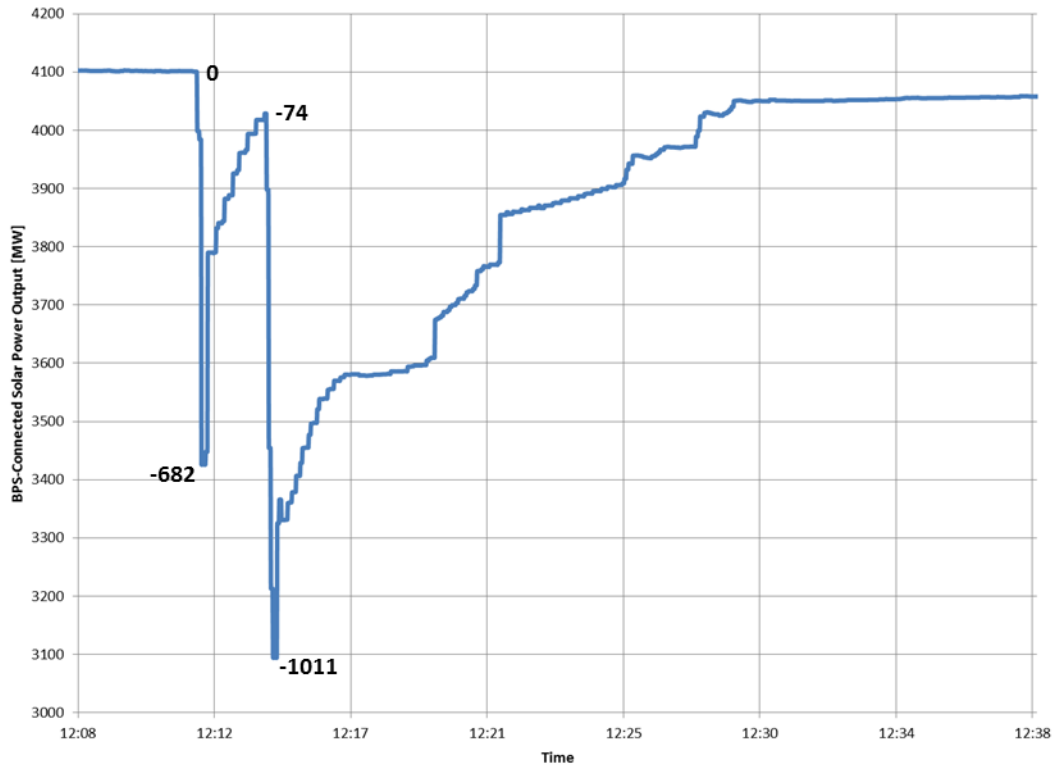

Figure 1.4: Solar PV Response during Canyon 2 Fire [Source: SCE]

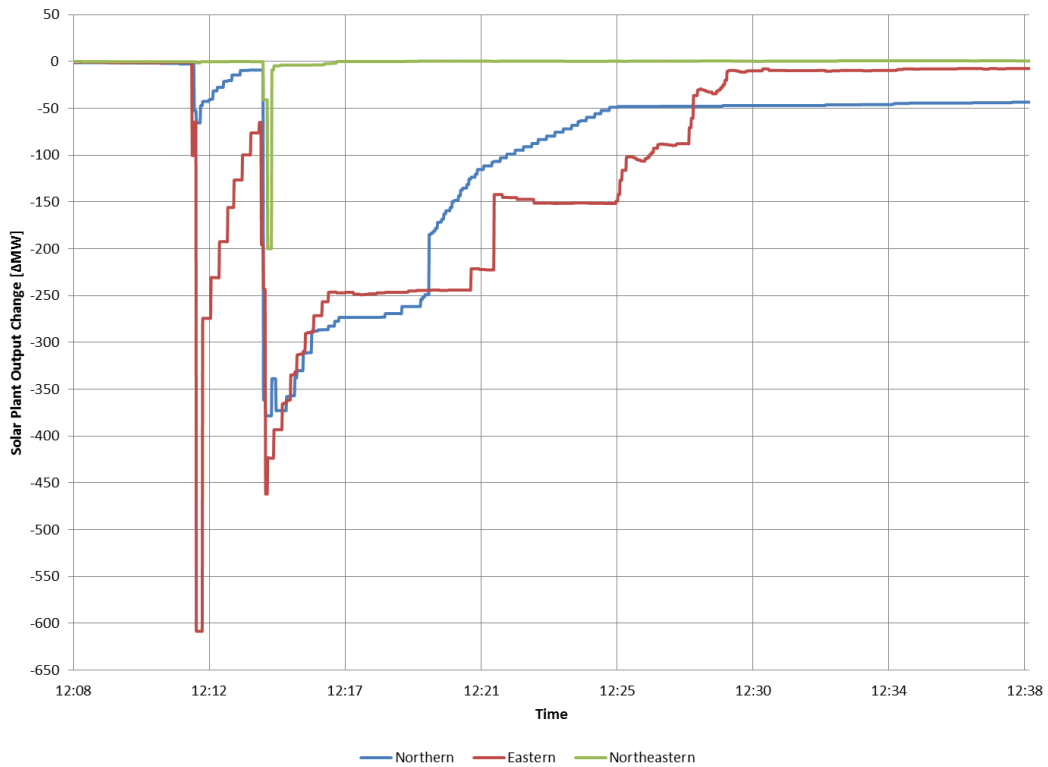

Figure 1.5: Regional Solar PV Response during Canyon 2 Fire [Source: SCE]

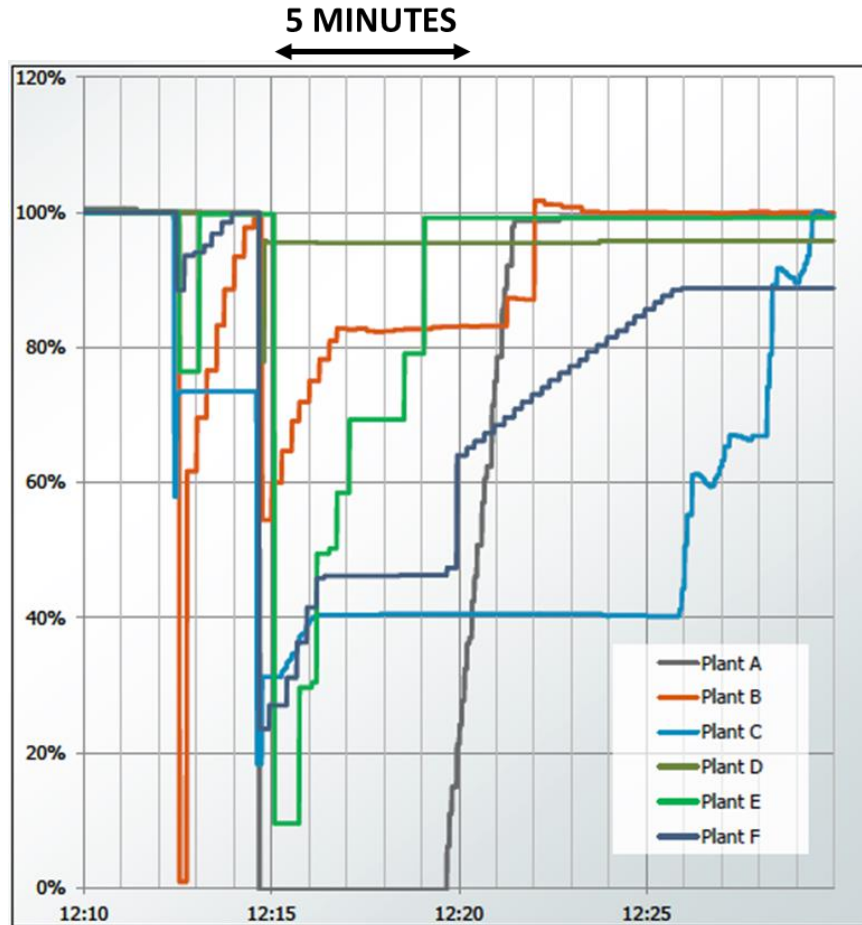

Figure 1.6: Response of Six Solar PV Plants Affected by the Fault Events [Source: SCE]

Table 1.1 provides an overview of the two fault events and the impacted solar PV during these disturbances.⁹ As mentioned, this does not capture all the resources that may have entered momentary cessation. According to SCE analysis, a relatively small amount of inverter-based resources connected to the distribution system (i.e., distributed energy resources (DERs)) tripped due to the bulk power system (BPS) faults. This report focuses solely on BPS-connected solar PV resources.

Table 1.1: Solar Photovoltaic Generation Loss						
Event No.	Date/Time	Fault Location	Fault Type	Clearing Time (cycles)	Lost Generation (MW)	Geographic Impact
1	10/09/2017 12:12:16	220 kV line	Line to Line (AB)	2.85	682	Somewhat Widespread
2	10/09/2017 12:14:30	500 kV line	Line to Line (AC)	2.86	937	Somewhat Widespread

⁹ The tabulated amount of solar PV tripped for each fault is based on the SCADA resolution data shown in Figure 1.4.

The 500 kV fault that resulted in over 900 MW solar PV resource loss caused a frequency excursion in the Western Interconnection with system frequency reaching a frequency nadir of 59.878 Hz about 3.3 seconds after the fault (see Figure 1.7). Frequency recovered to nominal in roughly 100 seconds. The NERC IRPTF is performing stability studies to determine if the momentary loss of inverter-based resources caused by momentary cessation poses any significant risk to frequency stability and if this should be considered in the resource loss protection criteria (RLPC) for the Western Interconnection (i.e., currently the loss of 2 Palo Verde generating units).

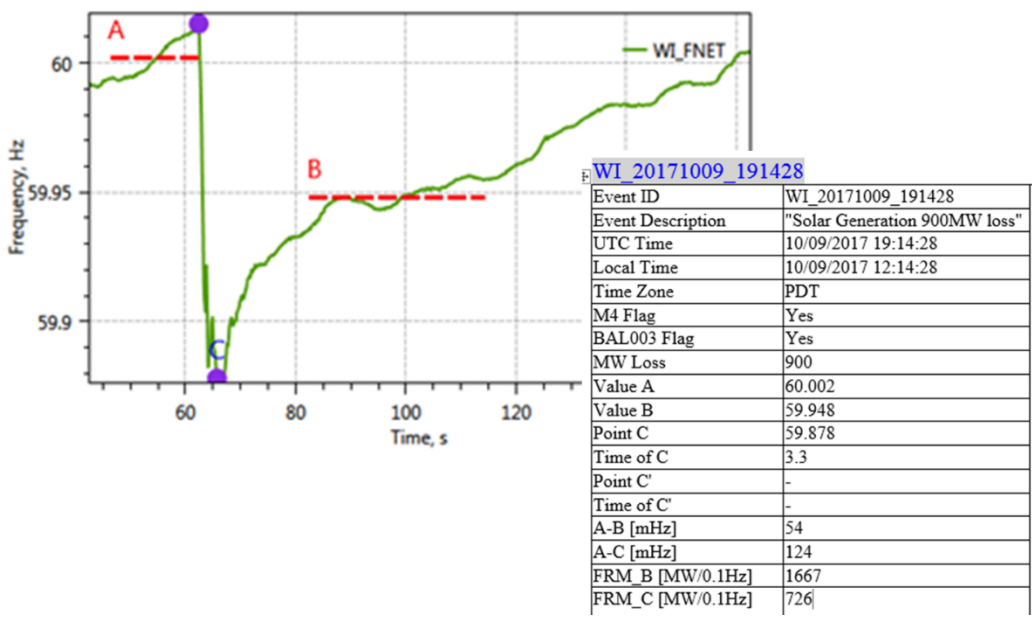

Figure 1.7: Western Interconnection Frequency during Second Fault

The Canyon 2 Fire disturbance occurred in the California Independent System Operator (CAISO) Balancing Authority (BA) area (see Figure 1.8). CAISO has experienced a rapid growth in solar PV resources recently and expects an increasing penetration of solar PV and inverter-based resources in the future. CAISO recorded a peak penetration level of 47.3 percent (9,292 MW solar generation, 19,641 MW CAISO load) of solar¹⁰ PV generation at 13:03 Pacific time on May 4, 2017. Near the time of the October 9 disturbances, CAISO recorded a penetration level of 34.3 percent (9179 MW solar generation, 26,740 MW CAISO load) of solar PV generation.

¹⁰ This includes both BPS-connected and DER solar PV.

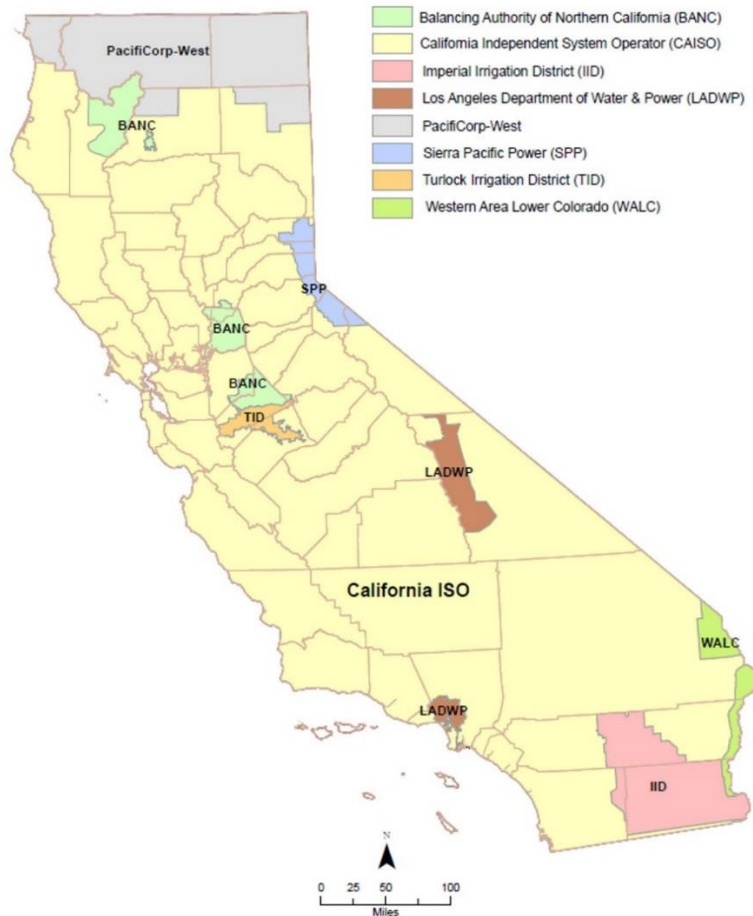

Figure 1.8: California Balancing Authority Areas

The Blue Cut Fire disturbance illuminated the issue of inverter-based resource disconnection caused by BPS faults. Since that disturbance, NERC has been coordinating with WECC, SCE, and CAISO to monitor for BPS disturbances that affect inverter-based resources. SCE identified the October 9, 2017, Canyon 2 Fire disturbance through proactive fault detection and analysis, with particular attention to the dynamic behavior of inverter-based resources. NERC will continue to work with its Regional Entities, inverter manufacturers, and industry to identify grid events where inverter-based resources are involved, analyze these events, and identify the root causes of unexpected performance from these resources.

The response of the affected solar PV generating resources was analyzed for each fault event. Key findings from this analysis are provided in more detail in Chapter 2, and recommendations to improve performance of solar PV resources are provided in Chapter 3.

Chapter 2: Analysis of Inverter-Based Resource Performance

While the Blue Cut Fire disturbance identified issues with erroneous frequency tripping during transient grid conditions and the use of momentary cessation by the majority of existing inverter-based resources, the following observations were made during analysis of the Canyon 2 Fire disturbance related to inverter-based resources:

- Erroneous frequency tripping was not a cause of solar PV resource tripping
- The majority of existing solar PV resources continue to use momentary cessation during abnormal voltage events
- Ramp rate limiters and interactions between inverters and plant controllers impeded the inverters from quickly restoring active power output to predisturbance levels following momentary cessation
- Interpretation of the PRC-024-2 voltage ride-through curve is an ongoing issue
- Instantaneous voltage tripping and a lack of voltage measurement filtering contributed to the event
- Phase lock loop synchronization issues contributed to the event
- Transient (voltage) interactions within the plant may have contributed to the event

These findings are discussed in more detail in the following sections of this chapter.

No Erroneous Frequency Tripping

No frequency-related tripping occurred during either of the two Canyon 2 Fire fault events. It appears that the mitigating actions of the inverter manufacturer and affected GOs has remediated the frequency-related issues identified during the Blue Cut Fire disturbance.

During the Blue Cut Fire disturbance, a significant amount of utility-scale solar PV tripped due to calculating an instantaneous frequency of less than 57 Hz during a transient voltage excursion caused by a fault on the grid and then taking incorrect protective action on that calculated frequency signal. NERC issued a NERC Alert¹¹ on June 20, 2017, as an outcome of the Blue Cut Fire disturbance report and recommended that Generator Owners (GOs) and Generator Operators (GOPs) ensure that their installed inverter controls do not trip for erroneous instantaneous frequency measurement during transients. The Level 2 NERC Alert recommendations carried mandatory reporting obligations for the industry, which responded by August 31, 2017. Responses from the NERC Alert indicated that over 6,200 MW (37% of total inverter capacity reported) of bulk power system (BPS)-connected solar PV generation was susceptible to the erroneous frequency calculation/protective action issues described in the Blue Cut Fire disturbance report.

The erroneous tripping due to calculated frequency issue was isolated to one inverter manufacturer, and that manufacturer has been proactively working with NERC, WECC, and the affected GOs to implement a 5-second duration (some may refer to this as delay) on any frequency-related tripping actions. By the completion of the NERC Alert (August 31, 2017), a total of 68 percent¹² of the affected generation had implemented the corrective action. By October 9, 2017, the inverter manufacturer had implemented the corrective action on over 97 percent of their transmission-connected solar PV inverters in CAISO.

¹¹ The Alert following the Blue Cut Fire can be found here:

<http://www.nerc.com/pa/rrm/bpsa/Alerts%20DL/NERC%20Alert%20Loss%20of%20Solar%20Resources%20during%20Transmission%20Disturbance.pdf>

¹² Percentage based on MW capacity.

Key Finding:

No inverter-based resources tripped due to frequency-related protective functions. Affected inverter manufacturers and GOs immediately responded to the recommendations from the Blue Cut Fire Disturbance Report to address the issues of erroneous tripping due to miscalculated frequency during transient conditions. Erroneous tripping due to miscalculated frequency appears to be remediated.

Continued Use of Momentary Cessation

During the October 9 disturbance, it was observed that solar PV resources continue to use momentary cessation. Sequence-of-event alarms and high-resolution measurements provided from inverter manufacturers and GOs/GOPs as part of the data request show this type of performance from the existing fleet. A number of PV resources included inverters that momentarily ceased production of current and subsequently tripped off-line due to overvoltage conditions (described in more detail in the following subsection “Instantaneous Voltage Tripping”).

Momentary cessation was also observed in the Blue Cut Fire disturbance, and the disturbance report highlighted that the majority of currently installed inverters are configured to momentarily cease current injection for voltages above 1.1 pu or below 0.9 pu. The report recommended that any resources using momentary cessation should be configured to restore output to predisturbance levels in no greater than five seconds, provided that the inverter is capable of these changes. This recommendation was predominantly based on rate of change of frequency for resource loss events in the Western Interconnection to ensure that the recovery of active power occurs before the frequency nadir is reached in the West.

However, this recommendation may need to be updated once further analysis and system stability studies are performed using realistic, worst-case dispatch conditions and sensitivities of inverter-based resource performance. The NERC Inverter-Based Resource Task Force (IRPTF) is currently investigating the impacts of momentary cessation to BPS stability and overall system reliability and will adjust this recommendation appropriately to ensure widespread BPS reliability. Initial stability studies conducted by the NERC IRPTF have identified potential wide-area stability problems when delays in restoration from momentary cessation exceed 0.5 seconds. The recommendation from the Blue Cut Fire disturbance report was intended to ensure reliability in the short-term; however, the use of momentary cessation is not recommended for newly interconnecting inverter-based resources and should be eliminated to the greatest extent possible for existing and future resources connected to the BPS. There may be exceptions to this recommendation when considering the use of momentary cessation for sub-cycle transient conditions to protect the power electronics. The NERC IRPTF will be providing detailed guidance on momentary cessation in a Reliability Guideline to be published in 2018.

NERC is also working with the inverter manufacturers to inventory the use of momentary cessation for each manufacturer and each model type for that manufacturer. This inventory is exploring how existing inverters are set and to what extent these settings can be modified to eliminate the use of momentary cessation in the existing inverter fleet. The information gathered in the inventory is informing the stability studies being performed by the NERC IRPTF.

Key Finding:

Solar PV resources continue to use momentary cessation most commonly for voltage magnitudes outside 0.9–1.1 pu. The use of momentary cessation is observed in sequence of events recording and high resolution measurement data. A more detailed assessment of the impacts of momentary cessation on BPS reliability is being studied by the NERC IRPTF, and the IRPTF may update the recommended performance specifications as applicable. The IRPTF is also inventorying the existing inverter fleet to understand the use of momentary cessation and the extent to which it can be eliminated for the existing fleet.

Recommendation:

The use of momentary cessation is not recommended, should not be used for new inverter-based resources, and should be eliminated or mitigated to the greatest extent possible for existing resources connected to the BPS. For existing resources that must use momentary cessation (as an equipment limitation), active current injection following voltage recovery should be restored very quickly (within 0.5 seconds). The NERC IRPTF should develop recommendations as to whether any conditions warrant the use of momentary cessation and perform dynamic simulations to understand the impacts of momentary cessation on BPS stability.

Ramp Rate Interactions with Recovery from Momentary Cessation

During the Canyon 2 Fire disturbance, multiple plants experienced ramp rate limiter interactions that impeded the inverters from recovering to precontingency active current injection quickly. Figure 2.1 shows identified conditions where the plant-level controller imposed ramp rates on the inverters following momentary cessation. This is not the intended operation of inverter-based resources and these interactions following fault conditions need to be remediated to ensure BPS transient and frequency stability (these ramp rates are typically imposed on active power, not reactive power).

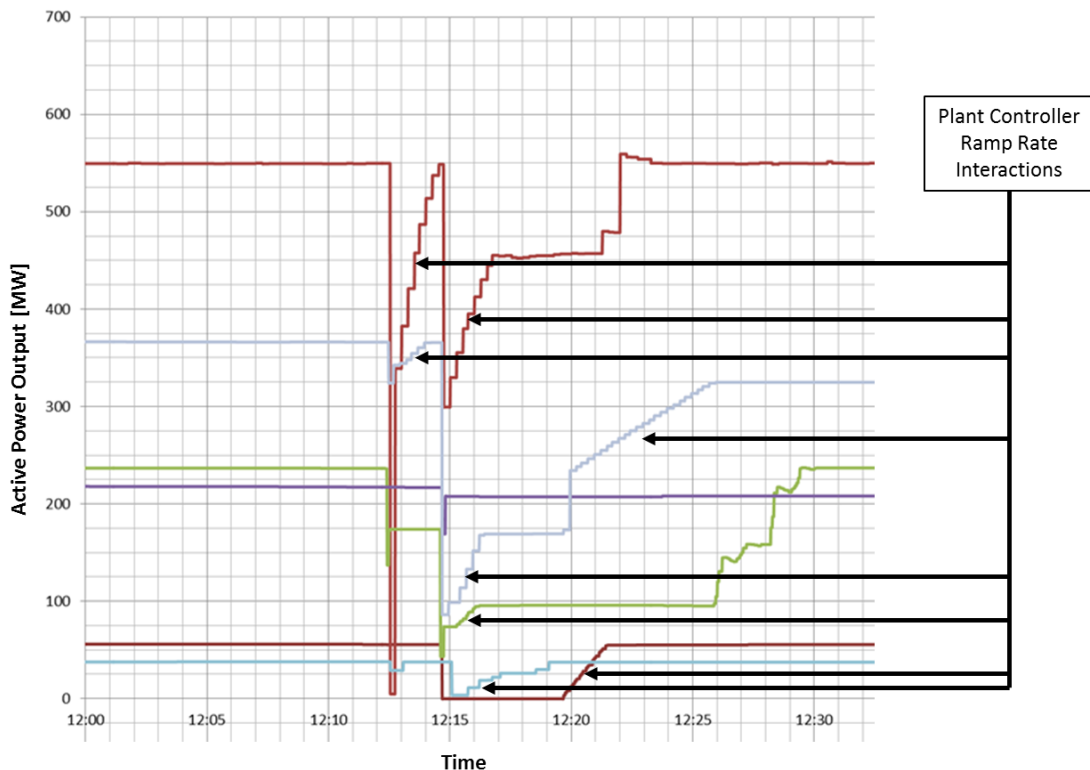

Figure 2.1: Plant Controller Ramp Rate Interactions

Ramp rates are used by Balancing Authorities (BAs) to aid in the balance of generation and demand to control grid frequency and BA area control error (ACE). BAs may have ramp rate limits on generating resources to ensure the plant does not change power output too quickly. This allows the BA to ensure that sufficient ramping resources are available to meet the expected or unexpected changes in generation or load in real-time operations.

Ramp rate limits are typically implemented at the plant-level controller to ensure that the overall plant active power output meets any BA ramping requirements.¹³ This controller is relatively slow, operating around a resolution of 100 ms (10 times per second) or slower. However, when voltage at the plant controller falls below a predetermined level (e.g., 0.9 pu), the plant controller freezes, sending commands based on when the inverters enter ride-through mode or momentary cessation where command values from the plant controller are ignored and each inverter uses its terminal conditions for control. If the inverter enters momentary cessation, it recovers active current injection to predisturbance levels within a programmable amount of time (e.g., within 0.5 seconds). Once voltage recovers to above the predetermined level, the plant controller will again begin sending commands for the inverters to follow. Ramp rates then become controlled by the plant controller again. The plant controller and inverter controls should be coordinated to ensure that active current injection returns to predisturbance levels unimpeded by any interaction with the ramp rate limits of the plant controller.

One inverter manufacturer also restores active current following momentary cessation to a predetermined level and then the maximum power point tracking (MPPT) control returns the output the remainder of the way. The MPPT ramp rates are much slower than the initial fast restoration in active current injection and should also not impede the inverter returning to predisturbance levels quickly (e.g., within 0.5 seconds). MPPT behavior during recovery from momentary cessation depends on how the inverter handles the MPPT control during momentary cessation—whether it freezes the output of the MPPT function to the predisturbance value or resets it to some default value. If the inverter uses a default value far from the operating value, control software changes should be made, if possible, to eliminate this interaction.

Existing inverter-based resources that are unable to eliminate the use of momentary cessation should restore current injection to precontingency levels very quickly (e.g., within 0.5 sec) following momentary cessation (as stated above). Active current injection should not be restricted by a plant-level controller. Generating facilities with this interaction should remediate this issue, in close coordination with their BA and inverter manufacturers, to ensure that ramp rates are still enabled appropriately to control gen-load balance but not applied to restoring output following momentary cessation.

¹³ Ramp rate limits may be implemented at the inverter-level if there is no plant-level controller.

Key Finding:

Inverter-based resources are returning to predisturbance outputs slower than desired because plant-level controller ramp rate limits used for balancing generation and load are being applied to inverter-based resources following momentary cessation. During ride-through conditions, the inverter controls its output and ignores signals sent by the plant-level controller. After voltage recovers and the inverter enters a normal operating range, it again responds to signals from the plant controller. The plant controller then applies its ramp rate limits to the remaining recovery of current injections, restraining the inverter from recovering quickly to its predisturbance current injection.

Recommendation:

Existing inverters where momentary cessation cannot be effectively eliminated should not be impeded from restoring current injection following momentary cessation. Active current injection should not be restricted by a plant-level controller or other slow ramp rate limits. Resources with this interaction should remediate the issue in close coordination with their BA and inverter manufacturers to ensure that ramp rates are still enabled appropriately to control gen-load balance but not applied to restoring output following momentary cessation. Plant controllers may consider including a short delay (e.g., 0.5 seconds) before sending commands following ride-through mode to ensure the inverter has fully recovered active current injection before resuming control.

Interpretation of PRC-024-2 Voltage Ride-Through Curve

All responses from the data request sent after the October 9, 2017, disturbance indicated that the PRC-024-2 voltage ride-through curve (see Figure 2.2 and Table 2.1) was used to set the voltage protective relay settings for inverters installed on the BPS. Some responses also indicated that the “may trip” zone is still interpreted as a “must trip” zone, despite the attempt in the Blue Cut Fire disturbance report to clarify the intent of PRC-024-2.

The PRC-024-2 ride-through curve is often used as the inverter voltage protection trip settings by default rather than considering equipment limitations to set the protective thresholds. The intent of the PRC-024-2 curve is not to specify a design criteria for resources. Rather, inverter protection settings should be based on the equipment specifications that may be wider than those of the PRC-024-2 curve. The IRPTF is investigating in simulations the potential impacts of all inverters in a geographical or electrical region tripping during voltage transients.

The intent of PRC-024-2 is to define the minimum and maximum voltage conditions where generating resources may trip for voltage excursions. The region outside the “no trip” zone should be interpreted as a “may trip” zone and not a “must trip” zone. Inverter settings should be determined based on equipment limitations and should be set to ride-through to the greatest extent possible. This helps support BPS reliability during and following grid events such as faults.

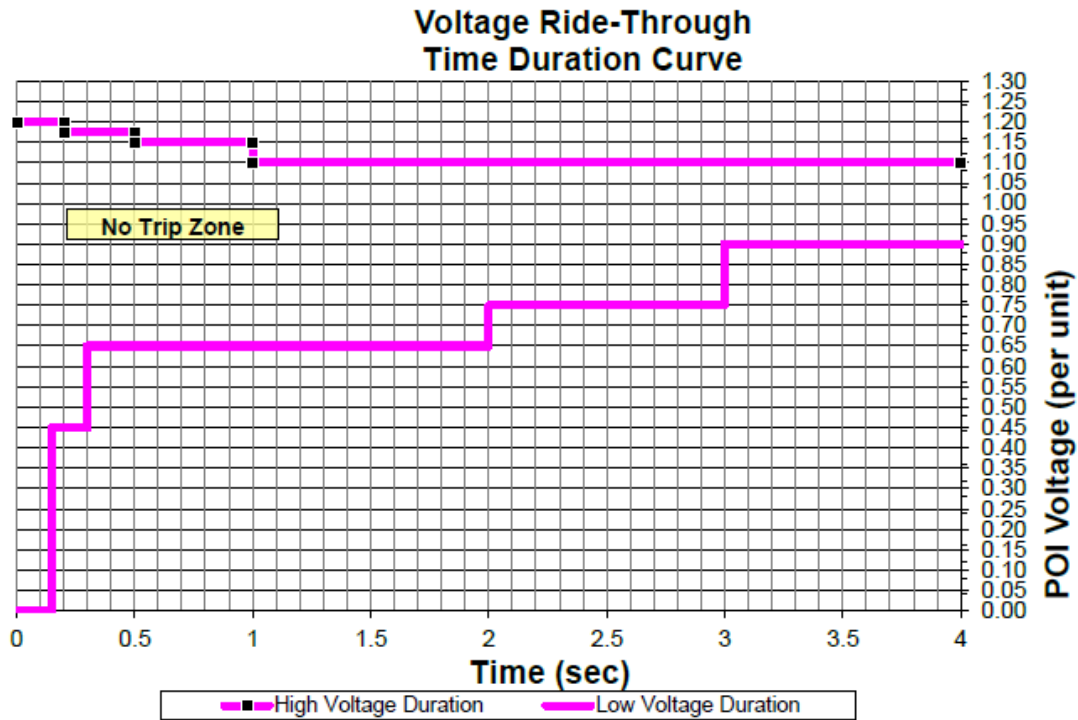

Figure 2.2: PRC-024-2 Voltage Ride-Through Curve

Table 2.1: PRC-024-2 Voltage Ride-Through Table

High Voltage Ride-Through Duration		Low Voltage Ride-Through Duration	
Voltage (pu)	Time (sec)	Voltage (pu)	Time (sec)
≥ 1.20	Instantaneous Trip	≤ 0.45	0.15
≥ 1.175	0.20	≤ 0.65	0.30
≥ 1.15	0.50	≤ 0.75	2.00
≥ 1.10	1.00	≤ 0.90	3.00

Key Finding:

Inverters currently installed on the BPS are using the PRC-024-2 voltage ride-through curve to set voltage protective relaying for the inverter. The curve is often used as the inverter protection trip settings by default rather than setting the protection to the widest extent possible while still protecting the equipment. The region outside of the PRC-024-2 voltage ride-through curve is being misinterpreted as a “must trip” region rather than a “may trip” region.

Recommendation:

Voltage protection functions in the inverters should be set based on physical equipment limitations to protect the inverter itself and should not be set based solely on the PRC-024-2 voltage ride-through characteristic. Within the “no trip” region of the curve, the inverters are expected to ride through and continue injecting current to the BPS. The region outside the curve should be interpreted as a “may trip” zone and not a “must trip” zone and protection should be set as wide as possible while still ensuring the reliability and integrity of the inverter-based resource.

Instantaneous Voltage Tripping

In the Canyon 2 Fire disturbance, inverters tripped due to a sub-cycle (less than quarter cycle) measured voltage above the overvoltage protective setting for the inverter (see Figure 2.3¹⁴ and Table 2.2). However, root-mean-square (RMS) trip settings should not be applied to instantaneously sampled voltage measurements. RMS trip settings should be applied to the fundamental frequency component of a filtered ac voltage waveform to avoid spurious tripping on transient overvoltages.

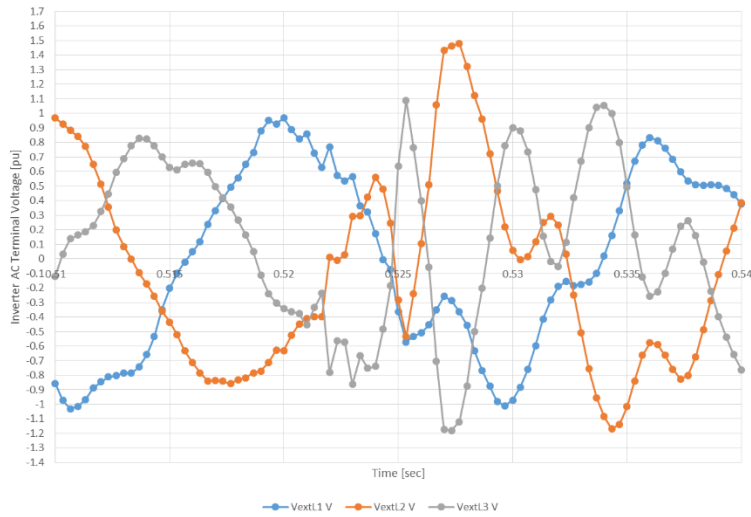

Figure 2.3: Phase Voltages during On-Fault Conditions

Table 2.2: Instantaneous Overvoltages during Transient Waveform			
Inst. Voltage [pu nominal peak]	Samples	Time [sec]	Cycles
> 1.1	5	0.00167	0.1
> 1.2	4	0.00133	0.08
> 1.3	4	0.00133	0.08
> 1.4	3	0.00100	0.06

The PRC-024-2 ride-through curve was derived based on conventional relaying philosophies. Modern digital protective relays typically use a filtered (e.g., bandpass filter) fundamental frequency RMS signal for voltage sensing, which eliminates any susceptibility to tripping for transient overvoltages. Instantaneous voltage values are not used since voltage transients are common on the BPS due to switching actions, fault clearing, lightning, etc. These types of transients should not result in protective relay action unless a fault condition exists, and relays are set using filtered quantities to ensure secure operation. Inverter protective functions should use a filtered, fundamental frequency voltage input for overvoltage protection when compared with the PRC-024-2 ride-through curve.

Responses from the data request and discussions with the inverter manufacturers identified the following:

- Lack of Voltage Measurement Filtering and Instantaneous Trip Settings:** Some inverter manufacturers use an unfiltered, high resolution voltage measurement (kHz range) for input to the inverter voltage protection functions. This type of sensing, coupled with an instantaneous trip setting, makes the inverter susceptible to unnecessary tripping on sub-cycle transient overvoltages. A number of BPS-connected solar PV resources tripped on “overvoltage protection” in this manner during the Canyon 2 Fire disturbance.

¹⁴ The per-unit base for the figure is the nominal instantaneous peak ac voltage.

- **Need for Protection Coordination Improvements:** During the October 9 disturbance, some manufacturers indicated that the ac circuit breaker tripped to protect the inverter from instantaneous overvoltage damage. However, inverter ac circuit breaker operation requires at least 2–3 cycles and is therefore not protecting the equipment from damage due to sub-cycle instantaneous overvoltages frequently seen during switching transients, faults, etc. This form of protection is too slow and results in insecure relay operation. Rather, surge arrestors are used to protect equipment from sub-cycle high magnitude transient overvoltages.

The NERC IRPTF has drafted the recommended transient overvoltage ride-through curve shown in Figure 2.4. Further details will be provided in the Reliability Guideline under development by the IRPTF. This curve differentiates between sub-cycle overvoltage that uses an instantaneously measured ac voltage value and RMS overvoltage that should use a well filtered, fundamental frequency RMS voltage measurement. The overvoltage ride-through limits on the RMS portion of the curve mirror PRC-024-2 while the limits on the sub-cycle instantaneous portion of the curve are based on new technology inverter capabilities, historical overvoltage events, known equipment limitations, and simulations of potential overvoltage conditions that can be expected at inverters on the BPS. Note that the RMS portion of the waveform applies to the POI of the inverter-based resources while the sub-cycle portion is a recommended specification for the inverters themselves.

Key Finding:

A large percentage of existing inverters on the BPS are configured with instantaneous overvoltage protection at the PRC-024-2 high voltage ride-through curve that does not use any form of filtering. Any instantaneous, sub-cycle transient overvoltage may trip the inverter off-line, making these resources susceptible to tripping on transients caused by faults and other switching actions.

Recommendation:

Inverter protective functions should use a filtered, fundamental frequency voltage input for overvoltage protection when compared with the PRC-024-2 ride-through curve. Any sub-cycle transient overvoltage protection, if applicable, should use voltage levels based on equipment limitation that are substantially higher than the PRC-024-2 curve.

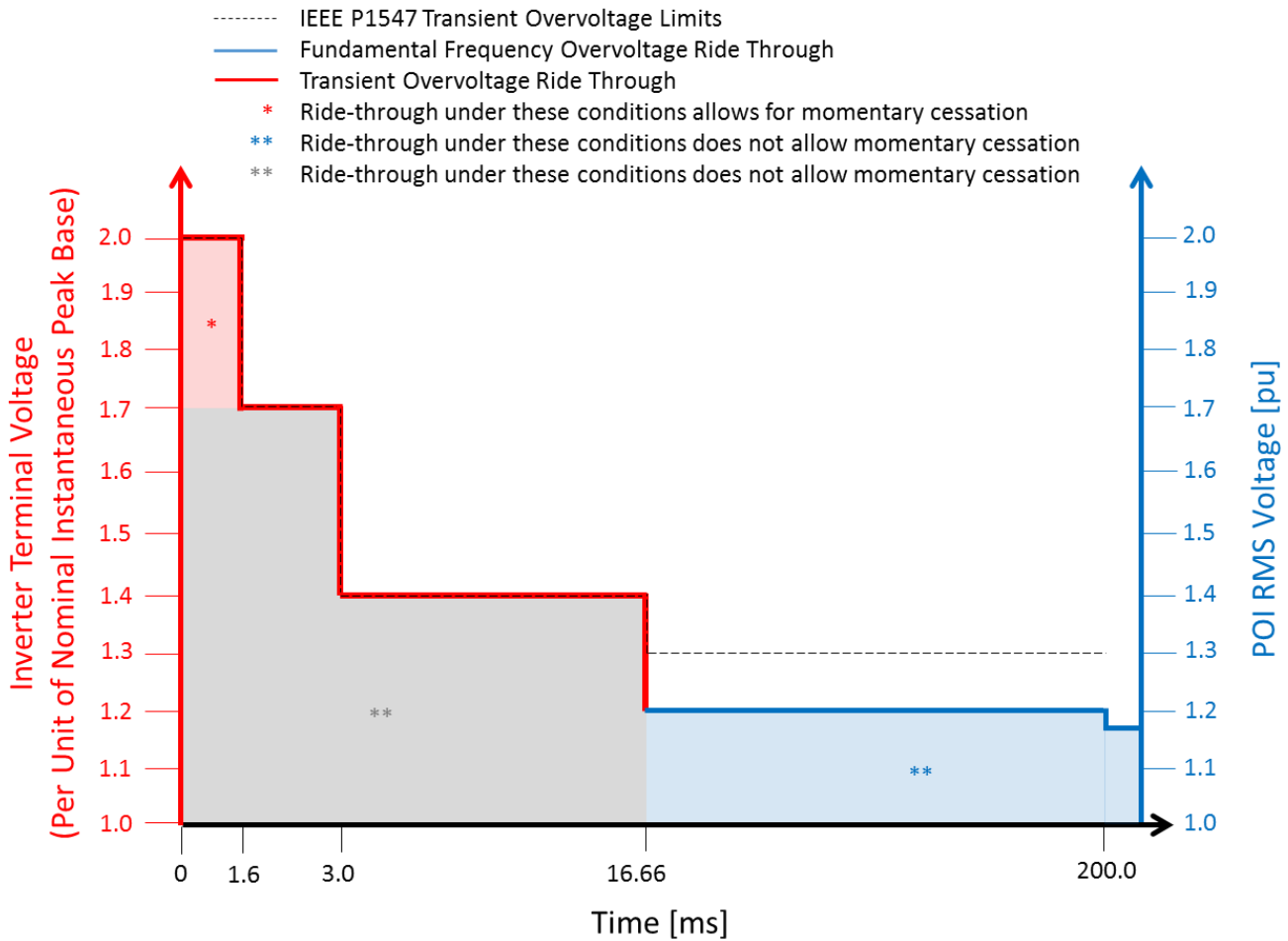

Figure 2.4: Recommended Overvoltage Ride-Through Curve

Phase Lock Loop Synchronization Issues

One inverter manufacturer reported fault codes for phase lock loop (PLL) synchronization issues, resulting in protective action to open the inverter primary circuit breaker. For these inverters, this action is taken for “complete loss or sudden fluctuation in grid voltage” that causes the inverter PLL to briefly lose synchronism with the ac grid waveform. This triggers a five-minute restart action by the inverter. At the plant where this occurred, other fault indicators also took action to trip the inverter and PLL loss of synchronism was not the primary cause of inverter tripping. However, other plants reported PLL loss of synchronism as the only fault code that tripped the inverters.

Momentary loss of synchronism does not cause direct damage to an inverter and should not result in tripping. Inverters should ride through momentary loss of synchronism caused by phase jumps, distortion, etc., during BPS grid events, such as faults. Inverters riding through these disturbances should continue to inject current into the grid and, at a minimum, lock the PLL to the last synchronized point and continue injecting current to the BPS at that calculated phase until the PLL can regain synchronism upon fault clearing. Any active or reactive current injections during this period should be limited by the inverter prior to any protective functions operating; the inverter should become a current-limited resource if maximum current injection conditions are specified by the inverter. Once synchronism is regained, the inverter should stably return to injecting current based on the synchronized PLL phase conditions.

Key Finding:

One inverter manufacturer reported fault codes for phase lock loop (PLL) synchronization issues, resulting in protective action to open the inverter primary circuit breaker.

Recommendation:

Inverters should ride through momentary loss of synchronism caused by phase jumps, distortion, etc., during BPS grid events, such as faults. Inverters riding through these disturbances should continue to inject current into the grid and, at a minimum, lock the PLL to the last synchronized point and continue injecting current to the BPS at that calculated phase until the PLL can regain synchronism upon fault clearing.

DC Reverse Current Tripping

One inverter manufacturer reported fault codes for dc reverse current, where protective action opened the inverter primary circuit breaker. The dc reverse current is considered a “major fault” by that manufacturer that requires a manual reset at the inverter. This resulted in the resources remaining off-line for an average of 81 minutes after tripping.

Inverters have anti-parallel diodes across the insulated-gate bipolar transistors (IGBTs), or switches in the power electronics (see illustration in Figure 2.5), to mitigate voltage spikes during switching. For inductive loads, like loads across the BPS, current through the inductor cannot change instantly otherwise transient voltage spikes occur. The anti-parallel diodes are used to allow current through the inductive load to go to zero. For example, when switches S1 and S2 are on, current flows left to right in the R-L load. When the half cycle is over, S1 and S2 turn off and S3 and S4 turn on. During this time, energy is fed back to the dc bus. During normal operation, this is a small amount of reverse current and is acceptable. During normal operation, the inverter is generating an ac waveform from the dc voltage through IGBT gating. This process necessitates the inverter to balance the ac voltage so as to keep the potential higher on the dc side. Normally this is not a problem; the maximum ac voltage the inverter can generate is sufficiently lower than the field dc voltage, thus current can flow out to the grid. However, ac transient over-voltages may cause the ac voltage to be greater than the dc voltage. This can lead to current flowing into the dc bus and PV arrays.

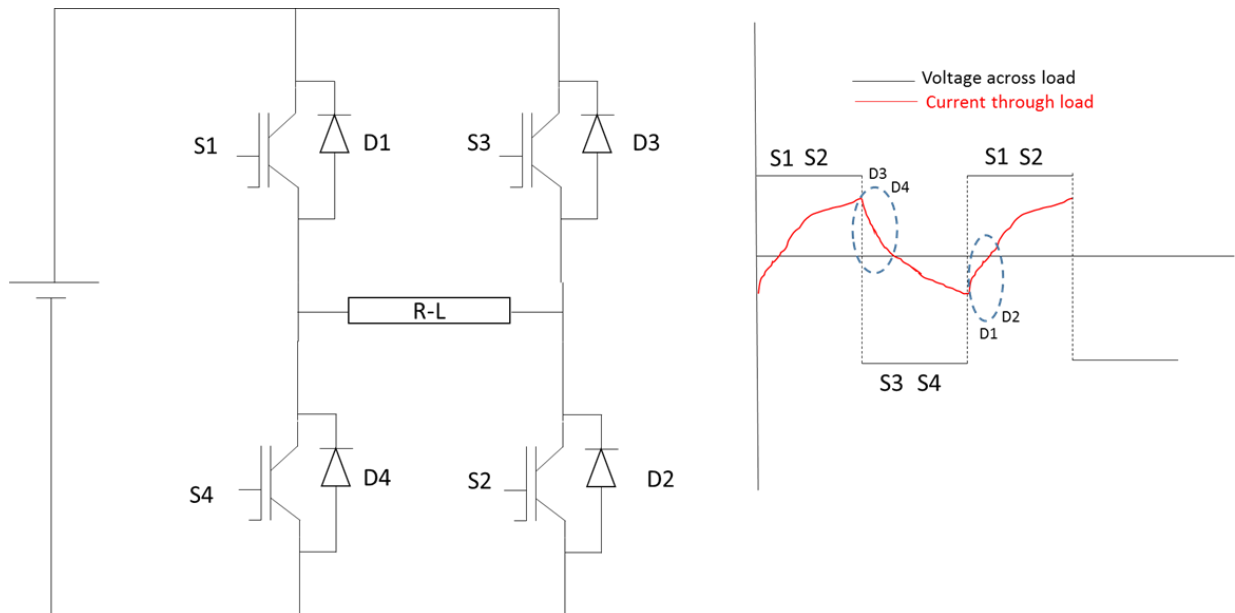

Figure 2.5: Online Illustration of Anti-Parallel Diodes

UL Std. 1741¹⁵ includes a testing requirement that any reverse current should not exceed the manufacturer's specification for maximum reverse current. The maximum dc reverse current specification here depends on the inverter, and is specified by the manufacturer. However, it does not specify a maximum duration and provides sufficient design flexibility that it should be feasible for inverters to not trip due to reverse current during transient ac over-voltages.

According to a number of equipment manufacturers, reverse current is not damaging to the inverters, the dc power source, nor the collector systems. Rather, detection and protection of this dc reverse current is used to protect the panels, particularly for local faults in the collector system. However, panels can be rated to at least 1–2 times rated current in the reverse direction. An inverse time characteristic can be used for dc reverse current protection. Instantaneous tripping should not be used unless current exceeds the dc reverse current rating of the panels. These protective settings should all be coordinated to avoid any unnecessary tripping on dc reverse current.

GOs should coordinate with their inverter manufacturers to ensure that dc reverse current detection and protection are set to avoid tripping for dc reverse currents that could result during sub-cycle transient overvoltage conditions since these are not likely to damage any equipment in the plant. Mitigating steps may include increasing the magnitude settings to align with the ratings of the equipment or implementing a short duration to the dc reverse current protection before sending the trip command. This will help avoid spurious tripping for very short duration (sub-cycle) transient overvoltages.

Key Finding:

One inverter manufacturer reported fault codes for dc reverse current, resulting in protective action to open the inverter primary circuit breaker. The dc reverse current is considered a “major fault” that requires a manual reset at the inverter, causing the resources to remain off-line for an average of 81 minutes after tripping.

Recommendation:

GOs should coordinate with their inverter manufacturers to ensure that dc reverse current detection and protection are set to avoid tripping for dc reverse currents that could result during sub-cycle transient overvoltage conditions since these are not likely to damage any equipment in the plant. Mitigating steps may include increasing the magnitude settings to align with the ratings of the equipment or implementing a short duration to the dc reverse current protection before sending the trip command.

Intra-Plant Transient Interactions and Ride-Through Considerations

Electromagnetic transient (EMT) studies are needed to identify any potential interactions between shunt compensation within the plant and inverter response to grid voltage depressions during fault conditions. Inverters responding with momentary cessation and with grid-supportive reactive current injection should both be analyzed to identify any potential implications with the different operating modes. The affected GOPs and Transmission Owners (TOs) should coordinate to perform EMT studies and explore any potential controls and protection issues that may exist.

Faults on the BPS result in depressed voltages across the BPS and can also cause significant voltage waveform distortion. Distortion in the voltage waveform can cause the inverter PLL to lose synchronism if severe enough. Inverter controls need to be robust enough to handle distorted waveform periods, particularly during fault conditions. Figure 2.6 shows the voltage (top) and current (bottom) at the point of measurement (POM) of an

¹⁵ UL 1741, “Standard for Inverters, Converters, Controllers and Interconnection System Equipment for Use with Distributed Energy Resources”. Available: https://standardscatalog.ul.com/standards/en/standard_1741_2.

inverter-based resource during the Canyon 2 Fire disturbance. The voltage waveform is significantly distorted during the on-fault conditions, and the inverter enters momentary cessation. Historically, inverters have used momentary cessation to ride through the grid disturbance. However, this is not the intended response of inverters since they are expected to ride through these disturbances and continue injecting current to the grid.

This particular solar PV facility entered into momentary cessation during the disturbance and subsequently tripped following fault clearing (as can be seen in the prolonged reduction in current in Figure 2.6) on “ac grid overvoltage” that occurred for less than a single electrical cycle. Plant operator(s) noted that many of the solar PV plants affected by the disturbance have shunt capacitor banks within the plant and that further study is needed to understand the interactions between shunt compensation, momentary cessation, and inverter tripping.

The potential interaction of in-plant shunt capacitors with the response of inverters during and after the fault conditions has been identified in this event as a potential cause for transient overvoltage and warrants further study. Prior to the disturbance, shunt compensation is in-service to support collector system voltages while the inverters are producing active power. When the fault occurs, grid voltages are depressed and most inverters enter into momentary cessation (cease injection of current to the BPS). Upon fault clearing, the inverters take a cycle or two to either ramp back up to predisturbance output or regain synchronism with the grid. During this time, the shunt capacitors are discharging on very low grid voltage. The combination of the inverter momentary cessation and response of the shunt compensation within the plant may be causing a large overshoot in plant voltages for a very short time (less than an electrical cycle). These voltage are not observed at the POM, as reported by TOs for these plants. However, the inverters are observing significantly higher voltage at their terminals, causing them to trip.

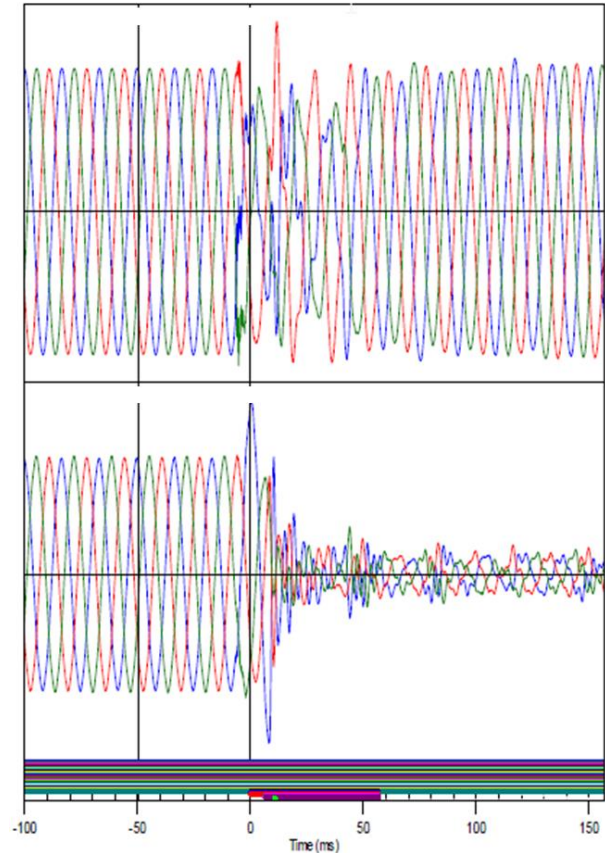

Figure 2.6: DFR Data at Plant POM

the inverter momentary cessation and response of the shunt compensation within the plant may be causing a large overshoot in plant voltages for a very short time (less than an electrical cycle). These voltage are not observed at the POM, as reported by TOs for these plants. However, the inverters are observing significantly higher voltage at their terminals, causing them to trip.

Key Finding:

During fault events, there appears to be an interrelationship between momentary cessation, in-plant shunt compensation, and transient overvoltage conditions that result in inverter tripping. While this has been observed at multiple locations for multiple events, the causes and effects are not well understood and require detailed EMT simulations for further investigation.

Recommendation:

EMT studies should be performed by the affected GOPs, in coordination with their TO(s), to better understand the cause of transient overvoltages resulting in inverter tripping. These studies should also identify why the observed inverter terminal voltages are much higher than the voltage at the point of measurement (POM), and any protection coordination needed to ride through these types of voltage conditions.

Chapter 3: Findings, Actions, and Recommendations

The following are key findings, actions, and recommendations for inverter-based resource performance as a direct outcome of the analysis of the October 9, 2017, Canyon 2 Fire disturbance:

Finding 1: No Erroneous Frequency Tripping

No inverter-based resources tripped due to frequency-related protective functions. Affected inverter manufacturers and Generator Owners (GOs) immediately responded to the recommendations from the Blue Cut Fire disturbance Report to address the issues of erroneous tripping due to miscalculated frequency during transient conditions. Erroneous tripping due to miscalculated frequency appears to be remediated.

Finding 2: Continued Use of Momentary Cessation

Solar PV resources continue to use momentary cessation, most commonly for voltage magnitudes outside 0.9–1.1 pu. The use of momentary cessation is observed in sequence of events recording and high resolution measurement data.

Action for Finding 2

The NERC Inverter-Based Resource Task Force (IRPTF) is performing stability studies for the Western Interconnection to more thoroughly investigate the potential implications of momentary cessation on system stability. The IRPTF is developing performance recommendations for use of momentary cessation only where existing resources may need to use it due to equipment limitations (based on the results of the studies). NERC is also inventorying momentary cessation for existing inverters based on manufacturer and model to understand its breadth of use and potential mitigation.

Recommendation 2

The use of momentary cessation is not recommended, should not be used for new inverter-based resources, and should be eliminated or mitigated to the greatest extent possible for existing resources connected to the bulk power system (BPS). For existing resources that must use momentary cessation (as an equipment limitation), active current injection following voltage recovery should be restored very quickly (within 0.5 seconds). The NERC IRPTF should develop recommendations as to whether any conditions warrant the use of momentary cessation and perform dynamic simulations to understand the impacts of momentary cessation on BPS stability.

Finding 3: Ramp Rate Interactions with Momentary Cessation

Inverter-based resources are returning to predisturbance outputs slower than desired because plant-level controller ramp rate limits used for balancing generation and load are being applied to inverter-based resources following momentary cessation. During ride-through conditions, the inverter controls its output and ignores signals sent by the plant-level controller. After voltage recovers and the inverter enters a normal operating range, it again responds to signals from the plant controller. The plant controller then applies its ramp rate limits to the remaining recovery of current injections, restraining the inverter from recovering quickly to its predisturbance current injection.

Recommendation 3

Existing inverters where momentary cessation cannot be effectively eliminated should not be impeded from restoring current injection following momentary cessation. Active current injection should not be restricted by a plant-level controller or other slow ramp rate limits. Resources with this interaction should remediate the issue in close coordination with their Balancing Authority (BA) and inverter manufacturers to ensure that ramp rates are still enabled appropriately to control gen-load balance but not applied to restoring output following momentary cessation. Plant controllers may consider including a short delay (e.g., 0.5 seconds) before sending commands

following ride-through mode to ensure the inverter has fully recovered active current injection before resuming control.

Finding 4: Interpretation of PRC-024-2 Voltage Ride-Through Curve

Many inverters currently installed on the BPS are set to trip when outside of the PRC-024-2 voltage ride-through curve. The curve is often used as the inverter protective trip settings rather than setting the protection to the widest extent possible while still protecting the equipment. The region outside of the PRC-024-2 voltage ride-through curve is being misinterpreted as a “must trip” region rather than a “may trip” region.

Action for Finding 4

NERC Event Analysis is developing a NERC Alert that will be issued to the industry to ensure that the intent of the PRC-024-2 curve and equipment voltage protective philosophies is understood. The purpose of the alert is to inform GOs of voltage-related inverter tripping risks during grid disturbances, and to ensure that GOs understand the steps that can be taken to mitigate these risks.

Recommendation 4

Voltage protection functions in the inverters should be set based on physical equipment limitations to protect the inverter itself and should not be set based solely on the PRC-024-2 voltage ride-through characteristic. Within the “no trip” region of the curve, the inverters are expected to ride through and continue injecting current to the BPS. The region outside the curve should be interpreted as a “may trip” zone and not a “must trip” zone and protection should be set as wide as possible while still ensuring the reliability and integrity of the inverter-based resource.

Finding 5: Instantaneous Voltage Tripping and Measurement Filtering

A large percentage of existing inverters on the BPS are configured to trip using instantaneous overvoltage protection, based on the PRC-024-2 high voltage ride-through curve, and do not filter out voltage transients. Any instantaneous, sub-cycle transient overvoltage may trip the inverter off-line, making these resources susceptible to tripping on transients caused by faults and other switching actions.

Recommendation 5

Inverter protective functions should use a filtered, fundamental frequency voltage input for overvoltage protection when compared with the PRC-024-2 ride-through curve.

Finding 6: Phase Lock Loop Synchronization Issues

One inverter manufacturer reported fault codes for phase lock loop (PLL) synchronization issues that resulted in protective action to open the inverter primary circuit breaker.

Recommendation 6

Inverters should not trip for momentary PLL loss of synchronism caused by phase jumps, distortion, etc., during BPS grid events (e.g., faults). Inverters should continue to inject current into the grid and, at a minimum, lock the PLL to the last synchronized point and continue injecting current to the BPS at that calculated phase until the PLL can regain synchronism upon fault clearing.

Finding 7: DC Reverse Current Tripping

One inverter manufacturer reported fault codes for dc reverse current, where protective action opened the inverter primary circuit breaker. The dc reverse current caused the resources to remain off-line for an average of 81 minutes after tripping because this is considered a “major fault” that requires a manual reset at the inverter.

Recommendation 7

GOs should coordinate with their inverter manufacturers to ensure that dc reverse current detection and protection are set to avoid tripping for dc reverse currents that could result during sub-cycle transient overvoltage conditions since these are not likely to damage any equipment in the plant. Mitigating steps may include increasing the magnitude settings to align with the ratings of the equipment, or implementing a short duration to the dc reverse current protection before sending the trip command.

Finding 8: Transient Interactions and Ride-Through Considerations

There appears to be an interrelationship between in-plant shunt compensation, sub-cycle transient overvoltage, and momentary cessation that results in inverter tripping. While this has been observed at multiple locations for multiple events, the causes and effects are not well understood and require detailed EMT simulations for further investigation.

Recommendation 8

EMT studies should be performed by the affected Generator Operators (GOPs), in coordination with their Transmission Owner(s) (TO(s)), to better understand the cause of transient overvoltages resulting in inverter tripping. These studies should also identify why the observed inverter terminal voltages are much higher than the voltage at the point of measurement (POM and any protection coordination needed to ride through these types of voltage conditions.

Additional Recommendations

- A NERC Alert should be issued to the NERC registered GOs to ensure they understand the intent of the PRC-024-2 curve and equipment voltage protective philosophies. The purpose of the alert is to mitigate unnecessary voltage-related inverter tripping during grid disturbances, and to ensure that GOs understand how to mitigate these risks.
- Generic dynamic stability models used during the interconnection process for studying reliability of the BPS do not accurately reflect all aspects of the behavior of inverter-based resources. Model improvements should be prioritized by industry groups developing these models (e.g., WECC Renewable Energy Modeling Task Force) to ensure that stability models sufficiently reflect the behavior of inverter-based resources installed today and in the future.
- Continued analyses of inverter-based resource performance under existing and future penetration levels are needed to determine if there are any reliability risks using control philosophies employed today. The ERO Enterprise and affected BAs should determine if potential resource loss events caused by momentary cessation or inverter tripping could pose a reliability risk.
- NERC and the NERC IRPTF should continue monitoring and analyzing grid events that involve inverter-based resources. Regional Entities should continue issuing data requests to GOs and GOPs when events indicate losses of inverter-based resources. Information collected from data requests, and follow-up discussions with inverter manufacturers and affected GOs and GOPs, significantly improves industry understanding of the performance characteristics of inverters connected to the BPS. The NERC IRPTF should include findings from this Disturbance Report and the Blue Cut Fire Disturbance Report in the Reliability Guideline that is being developed. NERC plans to publish the Reliability Guideline around September 2018.

Appendix A: Glossary of Terms and Acronyms

Acronym/Term	Definition
ACE	Area Control Error
BA	Balancing Authority
BAA	Balancing Authority Area
BES	Bulk Electric System
CAISO	California Independent System Operator
DER	Distributed Energy Resource
DFR	Digital Fault Recorder
ERO	Electric Reliability Organization
FERC	Federal Energy Regulatory Commission
FNET	Frequency Monitoring Network
GIA	Generator Interconnection Agreement
GO	Generator Owner
GOP	Generator Operator
IEEE	Institute of Electrical and Electronic Engineers
LADWP	Los Angeles Department of Water and Power
LL	Line-to-Line fault
MSSC	Most Severe Single Contingency
MW	Megawatt
NERC	North American Electric Reliability Corporation
OC	NERC Operating Committee
PF	Power Factor
PLL	Phase Lock Loop
p.u.	Per Unit
PV	Photovoltaic
RC	Reliability Coordinator
RE	Regional Entity
SCADA	Supervisory Control and Data Acquisition
SCE	Southern California Edison
SLG	Single-Line-to-Ground Fault
TO	Transmission Owner
TOP	Transmission Operator
VAR	Volt-Ampere Reactive
WECC	Western Electric Coordinating Council
UL	Underwriters Laboratories
Continuous Operation	Inverter operating mode where the inverter is injecting current into the grid while the grid is within specified parameters
Momentary Cessation	Inverter operating mode where the inverter temporarily ceases to inject current into the grid in response to a system voltage excursion with the capability of immediate restore output when the system voltage returns to normal
Restore Output	Return operation of the DER to the state prior to the abnormal excursion of voltage that resulted in Momentary Cessation
Trip mode	Inverter operating mode where current injection stops either due to mechanical or electrical disconnection. Return to service is delayed (typically around five minute delay)

Appendix B: October 9, 2017 Disturbance Analysis Team

The disturbance was analyzed by the following individuals. NERC gratefully acknowledges WECC, Southern California Edison, California ISO, and all the affected Generator Owners and Generator Operators. The coordination between all affected entities was crucial to identifying the key findings and developing recommendations for improved performance. NERC would also like to acknowledge the continued engagement and support of the inverter manufacturers, to ensure that the mitigating measures being developed are pragmatic. Lastly, all members of the NERC Inverter-Based Resource Performance Task Force (IRPTF) continue to help support NERC in its mission to ensure reliability, particularly faced with rapidly changing technology and grid performance characteristics.

Name	Company
Rich Bauer	NERC
Bob Cummings	NERC
James Merlo	NERC
Ryan Quint	NERC
Jule Tate	NERC
Steve Ashbaker	WECC
Katie Iversen	WECC
David Piper	SCE