

**Exhibit A**

**Proposed Reliability Standard**

**Exhibit A**

**Reliability Standard CIP-003-8 Clean and Redline**

## A. Introduction

1. **Title:** Cyber Security — Security Management Controls
2. **Number:** CIP-003-8
3. **Purpose:** To specify consistent and sustainable security management controls that establish responsibility and accountability to protect BES Cyber Systems against compromise that could lead to misoperation or instability in the Bulk Electric System (BES).
4. **Applicability:**
  - 4.1. **Functional Entities:** For the purpose of the requirements contained herein, the following list of functional entities will be collectively referred to as “Responsible Entities.” For requirements in this standard where a specific functional entity or subset of functional entities are the applicable entity or entities, the functional entity or entities are specified explicitly.
    - 4.1.1. **Balancing Authority**
    - 4.1.2. **Distribution Provider** that owns one or more of the following Facilities, systems, and equipment for the protection or restoration of the BES:
      - 4.1.2.1. Each underfrequency Load shedding (UFLS) or undervoltage Load shedding (UVLS) system that:
        - 4.1.2.1.1. is part of a Load shedding program that is subject to one or more requirements in a NERC or Regional Reliability Standard; and
        - 4.1.2.1.2. performs automatic Load shedding under a common control system owned by the Responsible Entity, without human operator initiation, of 300 MW or more.
      - 4.1.2.2. Each Remedial Action Scheme (RAS) where the RAS is subject to one or more requirements in a NERC or Regional Reliability Standard.
      - 4.1.2.3. Each Protection System (excluding UFLS and UVLS) that applies to Transmission where the Protection System is subject to one or more requirements in a NERC or Regional Reliability Standard.
      - 4.1.2.4. Each Cranking Path and group of Elements meeting the initial switching requirements from a Blackstart Resource up to and including the first interconnection point of the starting station service of the next generation unit(s) to be started.
    - 4.1.3. **Generator Operator**
    - 4.1.4. **Generator Owner**
    - 4.1.5. **Reliability Coordinator**
    - 4.1.6. **Transmission Operator**

#### 4.1.7. Transmission Owner

**4.2. Facilities:** For the purpose of the requirements contained herein, the following Facilities, systems, and equipment owned by each Responsible Entity in Section 4.1 above are those to which these requirements are applicable. For requirements in this standard where a specific type of Facilities, system, or equipment or subset of Facilities, systems, and equipment are applicable, these are specified explicitly.

**4.2.1. Distribution Provider:** One or more of the following Facilities, systems and equipment owned by the Distribution Provider for the protection or restoration of the BES:

**4.2.1.1.** Each UFLS or UVLS System that:

**4.2.1.1.1.** is part of a Load shedding program that is subject to one or more requirements in a NERC or Regional Reliability Standard; and

**4.2.1.1.2.** performs automatic Load shedding under a common control system owned by the Responsible Entity, without human operator initiation, of 300 MW or more.

**4.2.1.2.** Each RAS where the RAS is subject to one or more requirements in a NERC or Regional Reliability Standard.

**4.2.1.3.** Each Protection System (excluding UFLS and UVLS) that applies to Transmission where the Protection System is subject to one or more requirements in a NERC or Regional Reliability Standard.

**4.2.1.4.** Each Cranking Path and group of Elements meeting the initial switching requirements from a Blackstart Resource up to and including the first interconnection point of the starting station service of the next generation unit(s) to be started.

**4.2.2. Responsible Entities listed in 4.1 other than Distribution Providers:**

All BES Facilities.

**4.2.3. Exemptions:** The following are exempt from Standard CIP-003-8:

**4.2.3.1.** Cyber Assets at Facilities regulated by the Canadian Nuclear Safety Commission.

**4.2.3.2.** Cyber Assets associated with communication networks and data communication links between discrete Electronic Security Perimeters (ESPs).

**4.2.3.3.** The systems, structures, and components that are regulated by the Nuclear Regulatory Commission under a cyber security plan pursuant to 10 C.F.R. Section 73.54.

**4.2.3.4.** For Distribution Providers, the systems and equipment that are not included in section 4.2.1 above.



**5. Effective Dates:**

See Implementation Plan for CIP-003-8.

**6. Background:**

Standard CIP-003 exists as part of a suite of CIP Standards related to cyber security, which require the initial identification and categorization of BES Cyber Systems and require organizational, operational, and procedural controls to mitigate risk to BES Cyber Systems.

The term policy refers to one or a collection of written documents that are used to communicate the Responsible Entities' management goals, objectives and expectations for how the Responsible Entity will protect its BES Cyber Systems. The use of policies also establishes an overall governance foundation for creating a culture of security and compliance with laws, regulations, and standards.

The term documented processes refers to a set of required instructions specific to the Responsible Entity and to achieve a specific outcome. This term does not imply any naming or approval structure beyond what is stated in the requirements. An entity should include as much as it believes necessary in its documented processes, but it must address the applicable requirements.

The terms program and plan are sometimes used in place of documented processes where it makes sense and is commonly understood. For example, documented processes describing a response are typically referred to as plans (i.e., incident response plans and recovery plans). Likewise, a security plan can describe an approach involving multiple procedures to address a broad subject matter.

Similarly, the term program may refer to the organization's overall implementation of its policies, plans, and procedures involving a subject matter. Examples in the standards include the personnel risk assessment program and the personnel training program. The full implementation of the CIP Cyber Security Reliability Standards could also be referred to as a program. However, the terms program and plan do not imply any additional requirements beyond what is stated in the standards.

Responsible Entities can implement common controls that meet requirements for multiple high, medium, and low impact BES Cyber Systems. For example, a single cyber security awareness program could meet the requirements across multiple BES Cyber Systems.

Measures provide examples of evidence to show documentation and implementation of the requirement. These measures serve to provide guidance to entities in acceptable records of compliance and should not be viewed as an all-inclusive list.

Throughout the standards, unless otherwise stated, bulleted items in the requirements and measures are items that are linked with an "or," and numbered items are items that are linked with an "and."

Many references in the Applicability section use a threshold of 300 MW for UFLS and UVLS. This particular threshold of 300 MW for UVLS and UFLS was provided in Version 1 of the CIP Cyber Security Standards. The threshold remains at 300 MW since it is specifically addressing UVLS and UFLS, which are last ditch efforts to save the BES. A review of UFLS

tolerances defined within Regional Reliability Standards for UFLS program requirements to date indicates that the historical value of 300 MW represents an adequate and reasonable threshold value for allowable UFLS operational tolerances.

## B. Requirements and Measures

- R1.** Each Responsible Entity shall review and obtain CIP Senior Manager approval at least once every 15 calendar months for one or more documented cyber security policies that collectively address the following topics: *[Violation Risk Factor: Medium] [Time Horizon: Operations Planning]*
- 1.1.** For its high impact and medium impact BES Cyber Systems, if any:
    - 1.1.1.** Personnel and training (CIP-004);
    - 1.1.2.** Electronic Security Perimeters (CIP-005) including Interactive Remote Access;
    - 1.1.3.** Physical security of BES Cyber Systems (CIP-006);
    - 1.1.4.** System security management (CIP-007);
    - 1.1.5.** Incident reporting and response planning (CIP-008);
    - 1.1.6.** Recovery plans for BES Cyber Systems (CIP-009);
    - 1.1.7.** Configuration change management and vulnerability assessments (CIP-010);
    - 1.1.8.** Information protection (CIP-011); and
    - 1.1.9.** Declaring and responding to CIP Exceptional Circumstances.
  - 1.2.** For its assets identified in CIP-002 containing low impact BES Cyber Systems, if any:
    - 1.2.1.** Cyber security awareness;
    - 1.2.2.** Physical security controls;
    - 1.2.3.** Electronic access controls;
    - 1.2.4.** Cyber Security Incident response;
    - 1.2.5.** Transient Cyber Assets and Removable Media malicious code risk mitigation; and
    - 1.2.6.** Declaring and responding to CIP Exceptional Circumstances.
- M1.** Examples of evidence may include, but are not limited to, policy documents; revision history, records of review, or workflow evidence from a document management system that indicate review of each cyber security policy at least once every 15 calendar months; and documented approval by the CIP Senior Manager for each cyber security policy.
- R2.** Each Responsible Entity with at least one asset identified in CIP-002 containing low impact BES Cyber Systems shall implement one or more documented cyber security plan(s) for its low impact BES Cyber Systems that include the sections in Attachment 1. *[Violation Risk Factor: Lower] [Time Horizon: Operations Planning]*

Note: An inventory, list, or discrete identification of low impact BES Cyber Systems or their BES Cyber Assets is not required. Lists of authorized users are not required.

- M2.** Evidence shall include each of the documented cyber security plan(s) that collectively include each of the sections in Attachment 1 and additional evidence to demonstrate implementation of the cyber security plan(s). Additional examples of evidence per section are located in Attachment 2.
- R3.** Each Responsible Entity shall identify a CIP Senior Manager by name and document any change within 30 calendar days of the change. *[Violation Risk Factor: Medium]*  
*[Time Horizon: Operations Planning]*
- M3.** An example of evidence may include, but is not limited to, a dated and approved document from a high level official designating the name of the individual identified as the CIP Senior Manager.
- R4.** The Responsible Entity shall implement a documented process to delegate authority, unless no delegations are used. Where allowed by the CIP Standards, the CIP Senior Manager may delegate authority for specific actions to a delegate or delegates. These delegations shall be documented, including the name or title of the delegate, the specific actions delegated, and the date of the delegation; approved by the CIP Senior Manager; and updated within 30 days of any change to the delegation. Delegation changes do not need to be reinstated with a change to the delegator. *[Violation Risk Factor: Lower]* *[Time Horizon: Operations Planning]*
- M4.** An example of evidence may include, but is not limited to, a dated document, approved by the CIP Senior Manager, listing individuals (by name or title) who are delegated the authority to approve or authorize specifically identified items.

## C. Compliance

### 1. Compliance Monitoring Process

#### 1.1. Compliance Enforcement Authority:

As defined in the NERC Rules of Procedure, “Compliance Enforcement Authority” (CEA) means NERC or the Regional Entity in their respective roles of monitoring and enforcing compliance with the NERC Reliability Standards.

#### 1.2. Evidence Retention:

The following evidence retention periods identify the period of time an entity is required to retain specific evidence to demonstrate compliance. For instances where the evidence retention period specified below is shorter than the time since the last audit, the CEA may ask an entity to provide other evidence to show that it was compliant for the full time period since the last audit.

The Responsible Entity shall keep data or evidence to show compliance as identified below unless directed by its CEA to retain specific evidence for a longer period of time as part of an investigation:

- Each Responsible Entity shall retain evidence of each requirement in this standard for three calendar years.
- If a Responsible Entity is found non-compliant, it shall keep information related to the non-compliance until mitigation is complete and approved or for the time specified above, whichever is longer.
- The CEA shall keep the last audit records and all requested and submitted subsequent audit records.

#### 1.3. Compliance Monitoring and Assessment Processes:

- Compliance Audits
- Self-Certifications
- Spot Checking
- Compliance Investigations
- Self-Reporting
- Complaints

#### 1.4. Additional Compliance Information:

None.

## Violation Severity Levels

R #	Time Horizon	VRF	Violation Severity Levels (CIP-003-8)			
			Lower VSL	Moderate VSL	High VSL	Severe VSL
<b>R1</b>	<b>Operations Planning</b>	<b>Medium</b>	<p>The Responsible Entity documented and implemented one or more cyber security policies for its high impact and medium impact BES Cyber Systems, but did not address one of the nine topics required by R1. (R1.1)</p> <p>OR</p> <p>The Responsible Entity did not complete its review of the one or more documented cyber security policies for its high impact and medium impact BES Cyber Systems as required by R1 within 15 calendar months but did</p>	<p>The Responsible Entity documented and implemented one or more cyber security policies for its high impact and medium impact BES Cyber Systems, but did not address two of the nine topics required by R1. (R1.1)</p> <p>OR</p> <p>The Responsible Entity did not complete its review of the one or more documented cyber security policies for its high impact and medium impact BES Cyber Systems as required by R1 within 16 calendar months but did</p>	<p>The Responsible Entity documented and implemented one or more cyber security policies for its high impact and medium impact BES Cyber Systems, but did not address three of the nine topics required by R1. (R1.1)</p> <p>OR</p> <p>The Responsible Entity did not complete its review of the one or more documented cyber security policies for its high impact and medium impact BES Cyber Systems as required by R1 within 17 calendar months but did complete this review in less than or equal to 18</p>	<p>The Responsible Entity documented and implemented one or more cyber security policies for its high impact and medium impact BES Cyber Systems, but did not address four or more of the nine topics required by R1. (R1.1)</p> <p>OR</p> <p>The Responsible Entity did not have any documented cyber security policies for its high impact and medium impact BES Cyber Systems as required by R1. (R1.1)</p> <p>OR</p> <p>The Responsible Entity did not</p>

R #	Time Horizon	VRF	Violation Severity Levels (CIP-003-8)			
			Lower VSL	Moderate VSL	High VSL	Severe VSL
			<p>complete this review in less than or equal to 16 calendar months of the previous review. (R1.1)</p> <p>OR</p> <p>The Responsible Entity did not complete its approval of the one or more documented cyber security policies for its high impact and medium impact BES Cyber Systems as required by R1 by the CIP Senior Manager within 15 calendar months but did complete this approval in less than or equal to 16 calendar months of the previous approval. (R1.1)</p>	<p>complete this review in less than or equal to 17 calendar months of the previous review. (R1.1)</p> <p>OR</p> <p>The Responsible Entity did not complete its approval of the one or more documented cyber security policies for its high impact and medium impact BES Cyber Systems as required by R1 by the CIP Senior Manager within 16 calendar months but did complete this approval in less than or equal to 17 calendar months of the previous approval. (R1.1)</p>	<p>calendar months of the previous review. (R1.1)</p> <p>OR</p> <p>The Responsible Entity did not complete its approval of the one or more documented cyber security policies for its high impact and medium impact BES Cyber Systems as required by R1 by the CIP Senior Manager within 17 calendar months but did complete this approval in less than or equal to 18 calendar months of the previous approval. (R1)</p> <p>OR</p> <p>The Responsible Entity documented one or more cyber security policies for its assets identified in CIP-002 containing low impact</p>	<p>complete its review of the one or more documented cyber security policies as required by R1 within 18 calendar months of the previous review. (R1)</p> <p>OR</p> <p>The Responsible Entity did not complete its approval of the one or more documented cyber security policies for its high impact and medium impact BES Cyber Systems as required by R1 by the CIP Senior Manager within 18 calendar months of the previous approval. (R1.1)</p> <p>OR</p>

R #	Time Horizon	VRF	Violation Severity Levels (CIP-003-8)			
			Lower VSL	Moderate VSL	High VSL	Severe VSL
			<p>OR</p> <p>The Responsible Entity documented one or more cyber security policies for its assets identified in CIP-002 containing low impact BES Cyber Systems, but did not address one of the six topics required by R1. (R1.2)</p> <p>OR</p> <p>The Responsible Entity did not complete its review of the one or more documented cyber security policies for its assets identified in CIP-002 containing low impact BES Cyber Systems as required by Requirement R1 within 15 calendar</p>	<p>OR</p> <p>The Responsible Entity documented one or more cyber security policies for its assets identified in CIP-002 containing low impact BES Cyber Systems, but did not address two of the six topics required by R1. (R1.2)</p> <p>OR</p> <p>The Responsible Entity did not complete its review of the one or more documented cyber security policies for its assets identified in CIP-002 containing low impact BES Cyber Systems as required by Requirement R1 within 16 calendar</p>	<p>BES Cyber Systems, but did not address three of the six topics required by R1. (R1.2)</p> <p>OR</p> <p>The Responsible Entity did not complete its review of the one or more documented cyber security policies for its assets identified in CIP-002 containing low impact BES Cyber Systems as required by R1 within 17 calendar months but did not complete this review in less than or equal to 18 calendar months of the previous review. (R1.2)</p> <p>OR</p> <p>The Responsible Entity did not complete its approval of the one or more documented cyber security policies for its</p>	<p>The Responsible Entity documented one or more cyber security policies for its assets identified in CIP-002 containing low impact BES Cyber Systems, but did not address four or more of the six topics required by R1. (R1.2)</p> <p>OR</p> <p>The Responsible Entity did not have any documented cyber security policies for its assets identified in CIP-002 containing low impact BES Cyber Systems as required by R1. (R1.2)</p> <p>OR</p> <p>The Responsible Entity did not</p>



R #	Time Horizon	VRF	Violation Severity Levels (CIP-003-8)			
			Lower VSL	Moderate VSL	High VSL	Severe VSL
			<p>months but did complete this review in less than or equal to 16 calendar months of the previous review. (R1.2)</p> <p>OR</p> <p>The Responsible Entity did not complete its approval of the one or more documented cyber security policies for its assets identified in CIP-002 containing low impact BES Cyber Systems as required by Requirement R1 by the CIP Senior Manager within 15 calendar months but did complete this approval in less than or equal to 16 calendar months of</p>	<p>months but did complete this review in less than or equal to 17 calendar months of the previous review. (R1.2)</p> <p>OR</p> <p>The Responsible Entity did not complete its approval of the one or more documented cyber security policies for its assets identified in CIP-002 containing low impact BES Cyber Systems as required by Requirement R1 by the CIP Senior Manager within 16 calendar months but did complete this approval in less than or equal to 17</p>	<p>assets identified in CIP-002 containing low impact BES Cyber Systems as required by Requirement R1 by the CIP Senior Manager within 17 calendar months but did complete this approval in less than or equal to 18 calendar months of the previous approval. (R1.2)</p>	<p>complete its approval of the one or more documented cyber security policies for its assets identified in CIP-002 containing low impact BES Cyber Systems as required by Requirement R1 by the CIP Senior Manager within 18 calendar months of the previous approval. (R1.2)</p>

R #	Time Horizon	VRF	Violation Severity Levels (CIP-003-8)			
			Lower VSL	Moderate VSL	High VSL	Severe VSL
			the previous approval. (R1.2)	calendar months of the previous approval. (R1.2)		
<b>R2</b>	<b>Operations Planning</b>	<b>Lower</b>	<p>The Responsible Entity documented its cyber security plan(s) for its assets containing low impact BES Cyber Systems, but failed to document cyber security awareness according to Requirement R2, Attachment 1, Section 1. (R2)</p> <p>OR</p> <p>The Responsible Entity implemented electronic access controls but failed to document its cyber security plan(s) for electronic access controls according to Requirement R2,</p>	<p>The Responsible Entity documented its cyber security plan(s) for its assets containing low impact BES Cyber Systems, but failed to reinforce cyber security practices at least once every 15 calendar months according to Requirement R2, Attachment 1, Section 1. (R2)</p> <p>OR</p> <p>The Responsible Entity documented its cyber security plan(s) for its assets containing low impact BES Cyber Systems, but failed</p>	<p>The Responsible Entity documented the physical access controls for its assets containing low impact BES Cyber Systems, but failed to implement the physical security controls according to Requirement R2, Attachment 1, Section 2. (R2)</p> <p>OR</p> <p>The Responsible Entity documented its cyber security plan(s) for electronic access controls for its assets containing low impact BES Cyber Systems, but failed to permit only necessary inbound and outbound electronic</p>	<p>The Responsible Entity failed to document and implement one or more cyber security plan(s) for its assets containing low impact BES Cyber Systems according to Requirement R2, Attachment 1. (R2)</p>

R #	Time Horizon	VRF	Violation Severity Levels (CIP-003-8)			
			Lower VSL	Moderate VSL	High VSL	Severe VSL
			<p>Attachment 1, Section 3. (R2)</p> <p>OR</p> <p>The Responsible Entity documented its cyber security plan(s) for its assets containing low impact BES Cyber Systems, but failed to document one or more Cyber Security Incident response plan(s) according to Requirement R2, Attachment 1, Section 4. (R2)</p> <p>OR</p> <p>The Responsible Entity documented one or more Cyber Security Incident response plan(s) within its cyber security plan(s) for its assets containing</p>	<p>to document physical security controls according to Requirement R2, Attachment 1, Section 2. (R2)</p> <p>OR</p> <p>The Responsible Entity documented its cyber security plan(s) for its assets containing low impact BES Cyber Systems, but failed to document electronic access controls according to Requirement R2, Attachment 1, Section 3. (R2)</p> <p>OR</p> <p>The Responsible Entity documented its cyber security plan(s) for electronic access controls but</p>	<p>access controls according to Requirement R2, Attachment 1, Section 3.1. (R2)</p> <p>OR</p> <p>The Responsible Entity documented one or more Cyber Security Incident response plan(s) within its cyber security plan(s) for its assets containing low impact BES Cyber Systems, but failed to test each Cyber Security Incident response plan(s) at least once every 36 calendar months according to Requirement R2, Attachment 1, Section 4. (R2)</p> <p>OR</p> <p>The Responsible Entity documented the determination of</p>	

R #	Time Horizon	VRF	Violation Severity Levels (CIP-003-8)			
			Lower VSL	Moderate VSL	High VSL	Severe VSL
			low impact BES Cyber Systems, but failed to update each Cyber Security Incident response plan(s) within 180 days according to Requirement R2, Attachment 1, Section 4. (R2) OR The Responsible Entity documented its plan(s) for Transient Cyber Assets and Removable Media, but failed to manage its Transient Cyber Asset(s) according to Requirement R2, Attachment 1, Section 5.1. (R2) OR The Responsible Entity documented	failed to implement authentication for all Dial-up Connectivity that provides access to low impact BES Cyber System(s), per Cyber Asset capability according to Requirement R2, Attachment 1, Section 3.2 (R2) OR The Responsible Entity documented one or more incident response plan(s) within its cyber security plan(s) for its assets containing low impact BES Cyber Systems, but failed to include the process for identification, classification, and response to Cyber Security Incidents	whether an identified Cyber Security Incident is a Reportable Cyber Security Incident, but failed to notify the Electricity Information Sharing and Analysis Center (E-ISAC) according to Requirement R2, Attachment 1, Section 4. (R2) OR The Responsible Entity documented its plan(s) for Transient Cyber Assets and Removable Media, but failed to implement mitigation for the introduction of malicious code for Transient Cyber Assets managed by the Responsible Entity according to Requirement R2,	

R #	Time Horizon	VRF	Violation Severity Levels (CIP-003-8)			
			Lower VSL	Moderate VSL	High VSL	Severe VSL
			its plan(s) for Transient Cyber Assets, but failed to document the Removable Media section(s) according to Requirement R2, Attachment 1, Section 5.3. (R2)	according to Requirement R2, Attachment 1, Section 4. (R2)  OR The Responsible Entity documented its cyber security plan(s) for its assets containing low impact BES Cyber Systems, but failed to document the determination of whether an identified Cyber Security Incident is a Reportable Cyber Security Incident and subsequent notification to the Electricity Information Sharing and Analysis Center (E-ISAC) according to Requirement R2,	Attachment 1, Section 5.1. (R2)  OR The Responsible Entity documented its plan(s) for Transient Cyber Assets and Removable Media, but failed to implement mitigation for the introduction of malicious code for Transient Cyber Assets managed by a party other than the Responsible Entity according to Requirement R2, Attachment 1, Section 5.2. (R2)  OR The Responsible Entity documented its plan(s) for Transient Cyber Assets and Removable Media, but failed to implement mitigation for	

R #	Time Horizon	VRF	Violation Severity Levels (CIP-003-8)			
			Lower VSL	Moderate VSL	High VSL	Severe VSL
				<p>Attachment 1, Section 4. (R2)</p> <p>OR</p> <p>The Responsible Entity documented its plan(s) for Transient Cyber Assets and Removable Media, but failed to document mitigation for the introduction of malicious code for Transient Cyber Assets managed by the Responsible Entity according to Requirement R2, Attachment 1, Sections 5.1 and 5.3. (R2)</p> <p>OR</p> <p>The Responsible Entity documented its plan(s) for Transient Cyber</p>	<p>the threat of detected malicious code on the Removable Media prior to connecting Removable Media to a low impact BES Cyber System according to Requirement R2, Attachment 1, Section 5.3. (R2)</p>	

R #	Time Horizon	VRF	Violation Severity Levels (CIP-003-8)			
			Lower VSL	Moderate VSL	High VSL	Severe VSL
				<p>Assets and Removable Media, but failed to document mitigation for the introduction of malicious code for Transient Cyber Assets managed by a party other than the Responsible Entity according to Requirement R2, Attachment 1, Section 5.2. (R2)</p> <p>OR</p> <p>The Responsible Entity documented its plan(s) for Transient Cyber Assets and Removable Media, but failed to implement the Removable Media section(s) according to Requirement R2,</p>		

R #	Time Horizon	VRF	Violation Severity Levels (CIP-003-8)			
			Lower VSL	Moderate VSL	High VSL	Severe VSL
				Attachment 1, Section 5.3. (R2)		
<b>R3</b>	<b>Operations Planning</b>	<b>Medium</b>	The Responsible Entity has identified by name a CIP Senior Manager, but did not document changes to the CIP Senior Manager within 30 calendar days but did document this change in less than 40 calendar days of the change. (R3)	The Responsible Entity has identified by name a CIP Senior Manager, but did not document changes to the CIP Senior Manager within 40 calendar days but did document this change in less than 50 calendar days of the change. (R3)	The Responsible Entity has identified by name a CIP Senior Manager, but did not document changes to the CIP Senior Manager within 50 calendar days but did document this change in less than 60 calendar days of the change. (R3)	The Responsible Entity has not identified, by name, a CIP Senior Manager.  OR The Responsible Entity has identified by name a CIP Senior Manager, but did not document changes to the CIP Senior Manager within 60 calendar days of the change. (R3)
<b>R4</b>	<b>Operations Planning</b>	<b>Lower</b>	The Responsible Entity has identified a delegate by name, title, date of delegation, and specific actions delegated, but did	The Responsible Entity has identified a delegate by name, title, date of delegation, and specific actions delegated, but did	The Responsible Entity has identified a delegate by name, title, date of delegation, and specific actions delegated, but did not document changes to the delegate	The Responsible Entity has used delegated authority for actions where allowed by the CIP Standards, but does not have a process



R #	Time Horizon	VRF	Violation Severity Levels (CIP-003-8)			
			Lower VSL	Moderate VSL	High VSL	Severe VSL
			not document changes to the delegate within 30 calendar days but did document this change in less than 40 calendar days of the change. (R4)	not document changes to the delegate within 40 calendar days but did document this change in less than 50 calendar days of the change. (R4)	within 50 calendar days but did document this change in less than 60 calendar days of the change. (R4)	to delegate actions from the CIP Senior Manager. (R4)  OR The Responsible Entity has identified a delegate by name, title, date of delegation, and specific actions delegated, but did not document changes to the delegate within 60 calendar days of the change. (R4)

**D. Regional Variances**

None.

**E. Interpretations**

None.

**F. Associated Documents**

None.

## Version History

Version	Date	Action	Change Tracking
1	1/16/06	R3.2 — Change “Control Center” to “control center.”	3/24/06
2	9/30/09	<p>Modifications to clarify the requirements and to bring the compliance elements into conformance with the latest guidelines for developing compliance elements of standards.</p> <p>Removal of reasonable business judgment.</p> <p>Replaced the RRO with the RE as a responsible entity.</p> <p>Rewording of Effective Date.</p> <p>Changed compliance monitor to Compliance Enforcement Authority.</p>	
3	12/16/09	<p>Updated Version Number from -2 to -3</p> <p>In Requirement 1.6, deleted the sentence pertaining to removing component or system from service in order to perform testing, in response to FERC order issued September 30, 2009.</p>	
3	12/16/09	Approved by the NERC Board of Trustees.	
3	3/31/10	Approved by FERC.	
4	1/24/11	Approved by the NERC Board of Trustees.	
5	11/26/12	Adopted by the NERC Board of Trustees.	Modified to coordinate with other CIP standards and to revise format to use RBS Template.

Version	Date	Action	Change Tracking
5	11/22/13	FERC Order issued approving CIP-003-5.	
6	11/13/14	Adopted by the NERC Board of Trustees.	Addressed two FERC directives from Order No. 791 related to identify, assess, and correct language and communication networks.
6	2/12/15	Adopted by the NERC Board of Trustees.	Replaces the version adopted by the Board on 11/13/2014. Revised version addresses remaining directives from Order No. 791 related to transient devices and low impact BES Cyber Systems.
6	1/21/16	FERC Order issued approving CIP-003-6. Docket No. RM15-14-000	
7	2/9/17	Adopted by the NERC Board of Trustees.	Revised to address FERC Order No. 822 directives regarding (1) the definition of LERC and (2) transient devices.
7	4/19/18	FERC Order issued approving CIP-003-7. Docket No. RM17-11-000	

Version	Date	Action	Change Tracking
8	5/9/19	Adopted by the NERC Board of Trustees.	Removed SPS references.  Revised to address FERC Order No. 843 regarding mitigating the risk of malicious code.

## Attachment 1

### Required Sections for Cyber Security Plan(s) for Assets Containing Low Impact BES Cyber Systems

Responsible Entities shall include each of the sections provided below in the cyber security plan(s) required under Requirement R2.

Responsible Entities with multiple-impact BES Cyber Systems ratings can utilize policies, procedures, and processes for their high or medium impact BES Cyber Systems to fulfill the sections for the development of low impact cyber security plan(s). Each Responsible Entity can develop a cyber security plan(s) either by individual asset or groups of assets.

**Section 1.** Cyber Security Awareness: Each Responsible Entity shall reinforce, at least once every 15 calendar months, cyber security practices (which may include associated physical security practices).

**Section 2.** Physical Security Controls: Each Responsible Entity shall control physical access, based on need as determined by the Responsible Entity, to (1) the asset or the locations of the low impact BES Cyber Systems within the asset, and (2) the Cyber Asset(s), as specified by the Responsible Entity, that provide electronic access control(s) implemented for Section 3.1, if any.

**Section 3.** Electronic Access Controls: For each asset containing low impact BES Cyber System(s) identified pursuant to CIP-002, the Responsible Entity shall implement electronic access controls to:

- 3.1** Permit only necessary inbound and outbound electronic access as determined by the Responsible Entity for any communications that are:
  - i. between a low impact BES Cyber System(s) and a Cyber Asset(s) outside the asset containing low impact BES Cyber System(s);
  - ii. using a routable protocol when entering or leaving the asset containing the low impact BES Cyber System(s); and
  - iii. not used for time-sensitive protection or control functions between intelligent electronic devices (e.g., communications using protocol IEC TR-61850-90-5 R-GOOSE).
- 3.2** Authenticate all Dial-up Connectivity, if any, that provides access to low impact BES Cyber System(s), per Cyber Asset capability.

**Section 4.** Cyber Security Incident Response: Each Responsible Entity shall have one or more Cyber Security Incident response plan(s), either by asset or group of assets, which shall include:

- 4.1** Identification, classification, and response to Cyber Security Incidents;
- 4.2** Determination of whether an identified Cyber Security Incident is a Reportable Cyber Security Incident and subsequent notification to the

Electricity Information Sharing and Analysis Center (E-ISAC), unless prohibited by law;

- 4.3 Identification of the roles and responsibilities for Cyber Security Incident response by groups or individuals;
- 4.4 Incident handling for Cyber Security Incidents;
- 4.5 Testing the Cyber Security Incident response plan(s) at least once every 36 calendar months by: (1) responding to an actual Reportable Cyber Security Incident; (2) using a drill or tabletop exercise of a Reportable Cyber Security Incident; or (3) using an operational exercise of a Reportable Cyber Security Incident; and
- 4.6 Updating the Cyber Security Incident response plan(s), if needed, within 180 calendar days after completion of a Cyber Security Incident response plan(s) test or actual Reportable Cyber Security Incident.

**Section 5. Transient Cyber Asset and Removable Media Malicious Code Risk Mitigation:** Each Responsible Entity shall implement, except under CIP Exceptional Circumstances, one or more plan(s) to achieve the objective of mitigating the risk of the introduction of malicious code to low impact BES Cyber Systems through the use of Transient Cyber Assets or Removable Media. The plan(s) shall include:

- 5.1 For Transient Cyber Asset(s) managed by the Responsible Entity, if any, the use of one or a combination of the following in an ongoing or on-demand manner (per Transient Cyber Asset capability):
  - Antivirus software, including manual or managed updates of signatures or patterns;
  - Application whitelisting; or
  - Other method(s) to mitigate the introduction of malicious code.
- 5.2 For Transient Cyber Asset(s) managed by a party other than the Responsible Entity, if any:
  - 5.2.1 Use one or a combination of the following prior to connecting the Transient Cyber Asset to a low impact BES Cyber System (per Transient Cyber Asset capability):
    - Review of antivirus update level;
    - Review of antivirus update process used by the party;
    - Review of application whitelisting used by the party;
    - Review use of live operating system and software executable only from read-only media;
    - Review of system hardening used by the party; or

- Other method(s) to mitigate the introduction of malicious code.

**5.2.2** For any method used pursuant to 5.2.1, Responsible Entities shall determine whether any additional mitigation actions are necessary and implement such actions prior to connecting the Transient Cyber Asset.

**5.3** For Removable Media, the use of each of the following:

**5.3.1** Method(s) to detect malicious code on Removable Media using a Cyber Asset other than a BES Cyber System; and

**5.3.2** Mitigation of the threat of detected malicious code on the Removable Media prior to connecting Removable Media to a low impact BES Cyber System.

## Attachment 2

### Examples of Evidence for Cyber Security Plan(s) for Assets Containing Low Impact BES Cyber Systems

**Section 1.** Cyber Security Awareness: An example of evidence for Section 1 may include, but is not limited to, documentation that the reinforcement of cyber security practices occurred at least once every 15 calendar months. The evidence could be documentation through one or more of the following methods:

- Direct communications (for example, e-mails, memos, or computer-based training);
- Indirect communications (for example, posters, intranet, or brochures); or
- Management support and reinforcement (for example, presentations or meetings).

**Section 2.** Physical Security Controls: Examples of evidence for Section 2 may include, but are not limited to:

- Documentation of the selected access control(s) (e.g., card key, locks, perimeter controls), monitoring controls (e.g., alarm systems, human observation), or other operational, procedural, or technical physical security controls that control physical access to both:
  - a. The asset, if any, or the locations of the low impact BES Cyber Systems within the asset; and
  - b. The Cyber Asset(s) specified by the Responsible Entity that provide(s) electronic access controls implemented for Attachment 1, Section 3.1, if any.

**Section 3.** Electronic Access Controls: Examples of evidence for Section 3 may include, but are not limited to:

1. Documentation showing that at each asset or group of assets containing low impact BES Cyber Systems, routable communication between a low impact BES Cyber System(s) and a Cyber Asset(s) outside the asset is restricted by electronic access controls to permit only inbound and outbound electronic access that the Responsible Entity deems necessary, except where an entity provides rationale that communication is used for time-sensitive protection or control functions between intelligent electronic devices. Examples of such documentation may include, but are not limited to representative diagrams that illustrate control of inbound and outbound communication(s) between the low impact BES Cyber System(s) and a Cyber Asset(s) outside the asset containing low impact BES Cyber System(s) or lists of implemented electronic access controls (e.g., access control lists restricting IP addresses, ports, or services; implementing unidirectional gateways).



2. Documentation of authentication for Dial-up Connectivity (e.g., dial out only to a preprogrammed number to deliver data, dial-back modems, modems that must be remotely controlled by the control center or control room, or access control on the BES Cyber System).

**Section 4. Cyber Security Incident Response:** An example of evidence for Section 4 may include, but is not limited to, dated documentation, such as policies, procedures, or process documents of one or more Cyber Security Incident response plan(s) developed either by asset or group of assets that include the following processes:

1. to identify, classify, and respond to Cyber Security Incidents; to determine whether an identified Cyber Security Incident is a Reportable Cyber Security Incident and for notifying the Electricity Information Sharing and Analysis Center (E-ISAC);
2. to identify and document the roles and responsibilities for Cyber Security Incident response by groups or individuals (e.g., initiating, documenting, monitoring, reporting, etc.);
3. for incident handling of a Cyber Security Incident (e.g., containment, eradication, or recovery/incident resolution);
4. for testing the plan(s) along with the dated documentation that a test has been completed at least once every 36 calendar months; and
5. to update, as needed, Cyber Security Incident response plan(s) within 180 calendar days after completion of a test or actual Reportable Cyber Security Incident.

**Section 5. Transient Cyber Asset and Removable Media Malicious Code Risk Mitigation:**

1. Examples of evidence for Section 5.1 may include, but are not limited to, documentation of the method(s) used to mitigate the introduction of malicious code such as antivirus software and processes for managing signature or pattern updates, application whitelisting practices, processes to restrict communication, or other method(s) to mitigate the introduction of malicious code. If a Transient Cyber Asset does not have the capability to use method(s) that mitigate the introduction of malicious code, evidence may include documentation by the vendor or Responsible Entity that identifies that the Transient Cyber Asset does not have the capability.
2. Examples of evidence for Section 5.2.1 may include, but are not limited to, documentation from change management systems, electronic mail or procedures that document a review of the installed antivirus update level; memoranda, electronic mail, system documentation, policies or contracts from the party other than the Responsible Entity that identify the antivirus update process, the use of application whitelisting, use of live operating systems or system hardening performed by the party other than the Responsible Entity; evidence from change management systems, electronic mail or contracts that

identifies the Responsible Entity's acceptance that the practices of the party other than the Responsible Entity are acceptable; or documentation of other method(s) to mitigate malicious code for Transient Cyber Asset(s) managed by a party other than the Responsible Entity. If a Transient Cyber Asset does not have the capability to use method(s) that mitigate the introduction of malicious code, evidence may include documentation by the Responsible Entity or the party other than the Responsible Entity that identifies that the Transient Cyber Asset does not have the capability.

Examples of evidence for Attachment 1, Section 5.2.2 may include, but are not limited to, documentation from change management systems, electronic mail, or contracts that identifies a review to determine whether additional mitigation is necessary and has been implemented prior to connecting the Transient Cyber Asset managed by a party other than the Responsible Entity.

3. Examples of evidence for Section 5.3.1 may include, but are not limited to, documented process(es) of the method(s) used to detect malicious code such as results of scan settings for Removable Media, or implementation of on-demand scanning. Examples of evidence for Section 5.3.2 may include, but are not limited to, documented process(es) for the method(s) used for mitigating the threat of detected malicious code on Removable Media, such as logs from the method(s) used to detect malicious code that show the results of scanning and the mitigation of detected malicious code on Removable Media or documented confirmation by the entity that the Removable Media was deemed to be free of malicious code.

## Guidelines and Technical Basis

### Section 4 – Scope of Applicability of the CIP Cyber Security Standards

Section “4. Applicability” of the standards provides important information for Responsible Entities to determine the scope of the applicability of the CIP Cyber Security Requirements.

Section “4.1. Functional Entities” is a list of NERC functional entities to which the standard applies. If the entity is registered as one or more of the functional entities listed in Section 4.1, then the NERC CIP Cyber Security Standards apply. Note that there is a qualification in Section 4.1 that restricts the applicability in the case of Distribution Providers to only those that own certain types of systems and equipment listed in 4.2.

Section “4.2. Facilities” defines the scope of the Facilities, systems, and equipment owned by the Responsible Entity, as qualified in Section 4.1, that is subject to the requirements of the standard. In addition to the set of BES Facilities, Control Centers, and other systems and equipment, the list includes the set of systems and equipment owned by Distribution Providers. While the NERC Glossary term “Facilities” already includes the BES characteristic, the additional use of the term BES here is meant to reinforce the scope of applicability of these Facilities where it is used, especially in this applicability scoping section. This in effect sets the scope of Facilities, systems, and equipment that is subject to the standards.

#### Requirement R1:

In developing policies in compliance with Requirement R1, the number of policies and their content should be guided by a Responsible Entity's management structure and operating conditions. Policies might be included as part of a general information security program for the entire organization, or as components of specific programs. The Responsible Entity has the flexibility to develop a single comprehensive cyber security policy covering the required topics, or it may choose to develop a single high-level umbrella policy and provide additional policy detail in lower level documents in its documentation hierarchy. In the case of a high-level umbrella policy, the Responsible Entity would be expected to provide the high-level policy as well as the additional documentation in order to demonstrate compliance with CIP-003-8, Requirement R1.

If a Responsible Entity has any high or medium impact BES Cyber Systems, the one or more cyber security policies must cover the nine subject matter areas required by CIP-003-8, Requirement R1, Part 1.1. If a Responsible Entity has identified from CIP-002 any assets containing low impact BES Cyber Systems, the one or more cyber security policies must cover the six subject matter areas required by Requirement R1, Part 1.2.

Responsible Entities that have multiple-impact rated BES Cyber Systems are not required to create separate cyber security policies for high, medium, or low impact BES Cyber Systems. The Responsible Entities have the flexibility to develop policies that cover all three impact ratings.

Implementation of the cyber security policy is not specifically included in CIP-003-8, Requirement R1 as it is envisioned that the implementation of this policy is evidenced through successful implementation of CIP-003 through CIP-011. However, Responsible Entities are encouraged not to limit the scope of their cyber security policies to only those requirements in NERC cyber security Reliability Standards, but to develop a holistic cyber security policy

appropriate for its organization. Elements of a policy that extend beyond the scope of NERC's cyber security Reliability Standards will not be considered candidates for potential violations although they will help demonstrate the organization's internal culture of compliance and posture towards cyber security.

For Part 1.1, the Responsible Entity may consider the following for each of the required topics in its one or more cyber security policies for medium and high impact BES Cyber Systems, if any:

### 1.1.1 Personnel and training (CIP-004)

- Organization position on acceptable background investigations
- Identification of possible disciplinary action for violating this policy
- Account management

### 1.1.2 Electronic Security Perimeters (CIP-005) including Interactive Remote Access

- Organization stance on use of wireless networks
- Identification of acceptable authentication methods
- Identification of trusted and untrusted resources
- Monitoring and logging of ingress and egress at Electronic Access Points
- Maintaining up-to-date anti-malware software before initiating Interactive Remote Access
- Maintaining up-to-date patch levels for operating systems and applications used to initiate Interactive Remote Access
- Disabling VPN "split-tunneling" or "dual-homed" workstations before initiating Interactive Remote Access
- For vendors, contractors, or consultants: include language in contracts that requires adherence to the Responsible Entity's Interactive Remote Access controls

### 1.1.3 Physical security of BES Cyber Systems (CIP-006)

- Strategy for protecting Cyber Assets from unauthorized physical access
- Acceptable physical access control methods
- Monitoring and logging of physical ingress

### 1.1.4 System security management (CIP-007)

- Strategies for system hardening
- Acceptable methods of authentication and access control
- Password policies including length, complexity, enforcement, prevention of brute force attempts
- Monitoring and logging of BES Cyber Systems

- 1.1.5 Incident reporting and response planning (CIP-008)
  - Recognition of Cyber Security Incidents
  - Appropriate notifications upon discovery of an incident
  - Obligations to report Cyber Security Incidents
- 1.1.6 Recovery plans for BES Cyber Systems (CIP-009)
  - Availability of spare components
  - Availability of system backups
- 1.1.7 Configuration change management and vulnerability assessments (CIP-010)
  - Initiation of change requests
  - Approval of changes
  - Break-fix processes
- 1.1.8 Information protection (CIP-011)
  - Information access control methods
  - Notification of unauthorized information disclosure
  - Information access on a need-to-know basis
- 1.1.9 Declaring and responding to CIP Exceptional Circumstances
  - Processes to invoke special procedures in the event of a CIP Exceptional Circumstance
  - Processes to allow for exceptions to policy that do not violate CIP requirements

For Part 1.2, the Responsible Entity may consider the following for each of the required topics in its one or more cyber security policies for assets containing low impact BES Cyber Systems, if any:

- 1.2.1 Cyber security awareness
  - Method(s) for delivery of security awareness
  - Identification of groups to receive cyber security awareness
- 1.2.2 Physical security controls
  - Acceptable approach(es) for selection of physical security control(s)
- 1.2.3 Electronic access controls
  - Acceptable approach(es) for selection of electronic access control(s)
- 1.2.4 Cyber Security Incident response
  - Recognition of Cyber Security Incidents

- Appropriate notifications upon discovery of an incident
- Obligations to report Cyber Security Incidents

### 1.2.5 Transient Cyber Assets and Removable Media Malicious Code Risk Mitigation

- Acceptable use of Transient Cyber Asset(s) and Removable Media
- Method(s) to mitigate the risk of the introduction of malicious code to low impact BES Cyber Systems from Transient Cyber Assets and Removable Media
- Method(s) to request Transient Cyber Asset and Removable Media

### 1.2.6 Declaring and responding to CIP Exceptional Circumstances

- Process(es) to declare a CIP Exceptional Circumstance
- Process(es) to respond to a declared CIP Exceptional Circumstance

Requirements relating to exceptions to a Responsible Entity's security policies were removed because it is a general management issue that is not within the scope of a reliability requirement. It is an internal policy requirement and not a reliability requirement. However, Responsible Entities are encouraged to continue this practice as a component of their cyber security policies.

In this and all subsequent required approvals in the NERC CIP Reliability Standards, the Responsible Entity may elect to use hardcopy or electronic approvals to the extent that there is sufficient evidence to ensure the authenticity of the approving party.

#### **Requirement R2:**

The intent of Requirement R2 is for each Responsible Entity to create, document, and implement one or more cyber security plan(s) that address the security objective for the protection of low impact BES Cyber Systems. The required protections are designed to be part of a program that covers the low impact BES Cyber Systems collectively at an asset level (based on the list of assets containing low impact BES Cyber Systems identified in CIP-002), but not at an individual device or system level.

### **Requirement R2, Attachment 1**

As noted, Attachment 1 contains the sections that must be included in the cyber security plan(s). The intent is to allow entities that have a combination of high, medium, and low impact BES Cyber Systems the flexibility to choose, if desired, to cover their low impact BES Cyber Systems (or any subset) under their programs used for the high or medium impact BES Cyber Systems rather than maintain two separate programs. The purpose of the cyber security plan(s) in Requirement R2 is for Responsible Entities to use the cyber security plan(s) as a means of documenting their approaches to meeting the subject matter areas. The cyber security plan(s) can be used to reference other policies and procedures that demonstrate “how” the Responsible Entity is meeting each of the subject matter areas, or Responsible Entities can develop comprehensive cyber security plan(s) that contain all of the detailed implementation content solely within the cyber security plan itself. To meet the obligation for the cyber security plan, the expectation is that the cyber security plan contains or references sufficient details to address the implementation of each of the required subject matters areas.

Guidance for each of the subject matter areas of Attachment 1 is provided below.

#### **Requirement R2, Attachment 1, Section 1 – Cyber Security Awareness**

The intent of the cyber security awareness program is for entities to reinforce good cyber security practices with their personnel at least once every 15 calendar months. The entity has the discretion to determine the topics to be addressed and the manner in which it will communicate these topics. As evidence of compliance, the Responsible Entity should be able to produce the awareness material that was delivered according to the delivery method(s) (e.g., posters, emails, or topics at staff meetings, etc.). The standard drafting team does not intend for Responsible Entities to be required to maintain lists of recipients and track the reception of the awareness material by personnel.

Although the focus of the awareness is cyber security, it does not mean that only technology-related topics can be included in the program. Appropriate physical security topics (e.g., tailgating awareness and protection of badges for physical security, or “If you see something, say something” campaigns, etc.) are valid for cyber security awareness. The intent is to cover topics concerning any aspect of the protection of BES Cyber Systems.

#### **Requirement R2, Attachment 1, Section 2 – Physical Security Controls**

The Responsible Entity must document and implement methods to control physical access to (1) the asset or the locations of low impact BES Cyber Systems within the asset, and (2) Cyber Assets that implement the electronic access control(s) specified by the Responsible Entity in Attachment 1, Section 3.1, if any. If these Cyber Assets implementing the electronic access controls are located within the same asset as the low impact BES Cyber Asset(s) and inherit the same physical access controls and the same need as outlined in Section 2, this may be noted by the Responsible Entity in either its policies or cyber security plan(s) to avoid duplicate documentation of the same controls.

The Responsible Entity has the flexibility to select the methods used to meet the objective of controlling physical access to (1) the asset(s) containing low impact BES Cyber System(s) or the low impact BES Cyber Systems themselves and (2) the electronic access control Cyber Assets specified by the Responsible Entity, if any. The Responsible Entity may use one or a

combination of physical access controls, monitoring controls, or other operational, procedural, or technical physical security controls. Entities may use perimeter controls (e.g., fences with locked gates, guards, or site access policies, etc.) or more granular areas of physical access control in areas where low impact BES Cyber Systems are located, such as control rooms or control houses.

The security objective is to control the physical access based on need as determined by the Responsible Entity. The need for physical access can be documented at the policy level. The standard drafting team did not intend to obligate an entity to specify a need for each physical access or authorization of an individual for physical access.

Monitoring as a physical security control can be used as a complement or an alternative to physical access control. Examples of monitoring controls include, but are not limited to: (1) alarm systems to detect motion or entry into a controlled area, or (2) human observation of a controlled area. Monitoring does not necessarily require logging and maintaining logs but could include monitoring that physical access has occurred or been attempted (e.g., door alarm, or human observation, etc.). The standard drafting team's intent is that the monitoring does not need to be per low impact BES Cyber System but should be at the appropriate level to meet the security objective of controlling physical access.

User authorization programs and lists of authorized users for physical access are not required although they are an option to meet the security objective.

### **Requirement R2, Attachment 1, Section 3 – Electronic Access Controls**

Section 3 requires the establishment of electronic access controls for assets containing low impact BES Cyber Systems when there is routable protocol communication or Dial-up Connectivity between Cyber Asset(s) outside of the asset containing the low impact BES Cyber System(s) and the low impact BES Cyber System(s) within such asset. The establishment of electronic access controls is intended to reduce the risks associated with uncontrolled communication using routable protocols or Dial-up Connectivity.

When implementing Attachment 1, Section 3.1, Responsible Entities should note that electronic access controls to permit only necessary inbound and outbound electronic access are required for communications when those communications meet all three of the criteria identified in Attachment 1, Section 3.1. The Responsible Entity should evaluate the communications and when all three criteria are met, the Responsible Entity must document and implement electronic access control(s).

When identifying electronic access controls, Responsible Entities are provided flexibility in the selection of the electronic access controls that meet their operational needs while meeting the security objective of allowing only necessary inbound and outbound electronic access to low impact BES Cyber Systems that use routable protocols between a low impact BES Cyber System(s) and Cyber Asset(s) outside the asset.

In essence, the intent is for Responsible Entities to determine whether there is communication between a low impact BES Cyber System(s) and a Cyber Asset(s) outside the asset containing low impact BES Cyber System(s) that uses a routable protocol when entering or leaving the asset or Dial-up Connectivity to the low impact BES Cyber System(s). Where such



communication is present, Responsible Entities should document and implement electronic access control(s). Where routable protocol communication for time-sensitive protection or control functions between intelligent electronic devices that meets the exclusion language is present, Responsible Entities should document that communication, but are not required to establish any specific electronic access controls.

The inputs to this requirement are the assets identified in CIP-002 as containing low impact BES Cyber System(s); therefore, the determination of routable protocol communications or Dial-up Connectivity is an attribute of the asset. However, it is not intended for communication that provides no access to or from the low impact BES Cyber System(s), but happens to be located at the asset with the low impact BES Cyber System(s), to be evaluated for electronic access controls.

### Electronic Access Control Exclusion

In order to avoid future technology issues, the obligations for electronic access controls exclude communications between intelligent electronic devices that use routable communication protocols for time-sensitive protection or control functions, such as IEC TR-61850-90-5 R-GOOSE messaging. Time-sensitive in this context generally means functions that would be negatively impacted by the latency introduced in the communications by the required electronic access controls. This time-sensitivity exclusion does not apply to SCADA communications which typically operate on scan rates of 2 seconds or greater. While technically time-sensitive, SCADA communications over routable protocols can withstand the delay introduced by electronic access controls. Examples of excluded time-sensitive communications are those communications which may necessitate the tripping of a breaker within a few cycles. A Responsible Entity using this technology is not expected to implement the electronic access controls noted herein. This exception was included so as not to inhibit the functionality of the time-sensitive characteristics related to this technology and not to preclude the use of such time-sensitive reliability enhancing functions if they use a routable protocol in the future.

### **Considerations for Determining Routable Protocol Communications**

To determine whether electronic access controls need to be implemented, the Responsible Entity has to determine whether there is communication between a low impact BES Cyber System(s) and a Cyber Asset(s) outside the asset containing the low impact BES Cyber System(s) that uses a routable protocol when entering or leaving the asset.

When determining whether a routable protocol is entering or leaving the asset containing the low impact BES Cyber System(s), Responsible Entities have flexibility in identifying an approach. One approach is for Responsible Entities to identify an “electronic boundary” associated with the asset containing low impact BES Cyber System(s). This is not an Electronic Security Perimeter *per se*, but a demarcation that demonstrates the routable protocol communication entering or leaving the asset between a low impact BES Cyber System and Cyber Asset(s) outside the asset to then have electronic access controls implemented. This electronic boundary may vary by asset type (Control Center, substation, generation resource) and the specific configuration of the asset. If this approach is used, the intent is for the Responsible Entity to define the electronic boundary such that the low impact BES Cyber System(s) located

at the asset are contained within the “electronic boundary.” This is strictly for determining which routable protocol communications and networks are internal or inside or local to the asset and which are external to or outside the asset.

Alternatively, the Responsible Entity may find the concepts of what is inside and outside to be intuitively obvious for a Cyber Asset(s) outside the asset containing low impact BES Cyber System(s) communicating to a low impact BES Cyber System(s) inside the asset. This may be the case when a low impact BES Cyber System(s) is communicating with a Cyber Asset many miles away and a clear and unambiguous demarcation exists. In this case, a Responsible Entity may decide not to identify an “electronic boundary,” but rather to simply leverage the unambiguous asset demarcation to ensure that the electronic access controls are placed between the low impact BES Cyber System(s) and the Cyber Asset(s) outside the asset.

### **Determining Electronic Access Controls**

Once a Responsible Entity has determined that there is routable communication between a low impact BES Cyber System(s) and a Cyber Asset(s) outside the asset containing the low impact BES Cyber System(s) that uses a routable protocol when entering or leaving the asset containing the low impact BES Cyber System(s), the intent is for the Responsible Entity to document and implement its chosen electronic access control(s). The control(s) are intended to allow only “necessary” inbound and outbound electronic access as determined by the Responsible Entity. However the Responsible Entity chooses to document the inbound and outbound access permissions and the need, the intent is that the Responsible Entity is able to explain the reasons for the electronic access permitted. The reasoning for “necessary” inbound and outbound electronic access controls may be documented within the Responsible Entity’s cyber security plan(s), within a comment on an access control list, a database, spreadsheet or other policies or procedures associated with the electronic access controls.

### **Concept Diagrams**

The diagrams on the following pages are provided as examples to illustrate various electronic access controls at a conceptual level. Regardless of the concepts or configurations chosen by the Responsible Entity, the intent is to achieve the security objective of permitting only necessary inbound and outbound electronic access for communication between low impact BES Cyber Systems and Cyber Asset(s) outside the asset containing the low impact BES Cyber System(s) using a routable protocol when entering or leaving the asset.

### **NOTE:**

- This is not an exhaustive list of applicable concepts.
- The same legend is used in each diagram; however, the diagram may not contain all of the articles represented in the legend.

### Reference Model 1 – Host-based Inbound & Outbound Access Permissions

The Responsible Entity may choose to utilize a host-based firewall technology on the low impact BES Cyber System(s) itself that manages the inbound and outbound electronic access permissions so that only necessary inbound and outbound electronic access is allowed between the low impact BES Cyber System(s) and the Cyber Asset(s) outside the asset containing the low impact BES Cyber System(s). When permitting the inbound and outbound electronic access permissions using access control lists, the Responsible Entity could restrict communication(s) using source and destination addresses or ranges of addresses. Responsible Entities could also restrict communication(s) using ports or services based on the capability of the electronic access control, the low impact BES Cyber System(s), or the application(s).

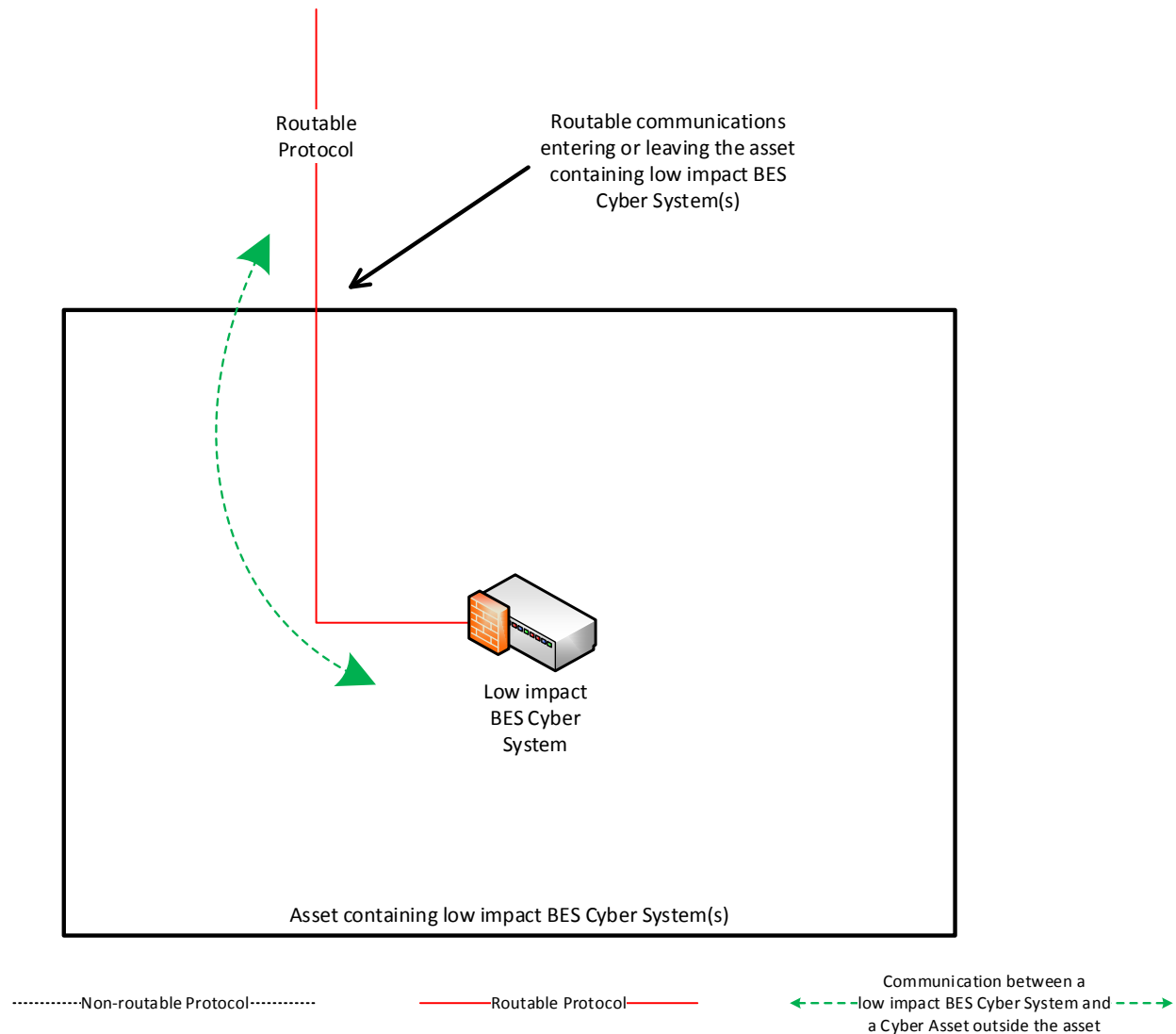

*Reference Model 1*

**Reference Model 2 – Network-based Inbound & Outbound Access Permissions**

The Responsible Entity may choose to use a security device that permits only necessary inbound and outbound electronic access to the low impact BES Cyber System(s) within the asset containing the low impact BES Cyber System(s). In this example, two low impact BES Cyber Systems are accessed using the routable protocol that is entering or leaving the asset containing the low impact BES Cyber System(s). The IP/Serial converter is continuing the same communications session from the Cyber Asset(s) that are outside the asset to the low impact BES Cyber System(s). The security device provides the electronic access controls to permit only necessary inbound and outbound routable protocol access to the low impact BES Cyber System(s). When permitting the inbound and outbound electronic access permissions using access control lists, the Responsible Entity could restrict communication(s) using source and destination addresses or ranges of addresses. Responsible Entities could also restrict communication(s) using ports or services based on the capability of the electronic access control, the low impact BES Cyber System(s), or the application(s).

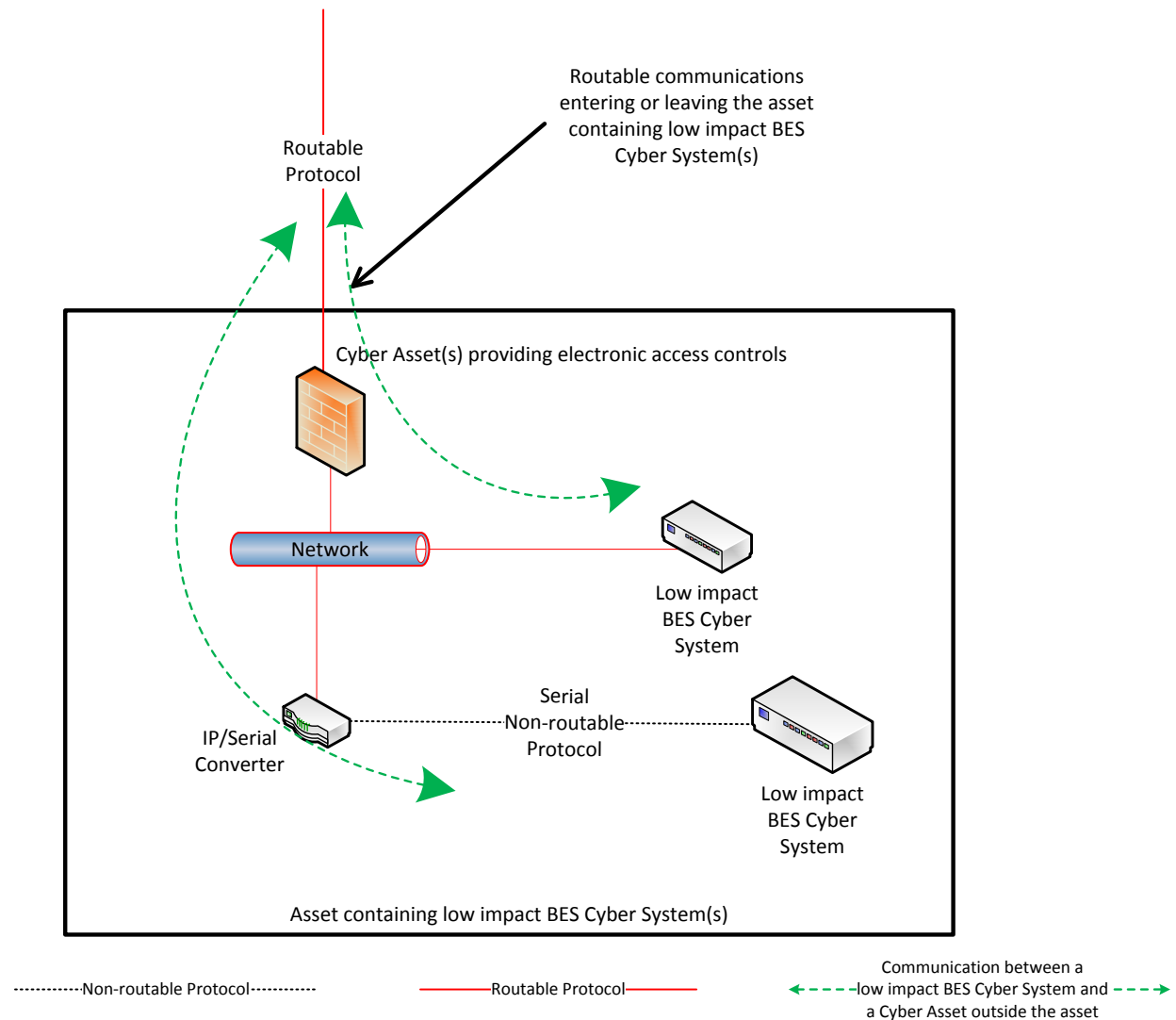

*Reference Model 2*

### Reference Model 3 – Centralized Network-based Inbound & Outbound Access Permissions

The Responsible Entity may choose to utilize a security device at a centralized location that may or may not be at another asset containing low impact BES Cyber System(s). The electronic access control(s) do not necessarily have to reside inside the asset containing the low impact BES Cyber System(s). A security device is in place at “Location X” to act as the electronic access control and permit only necessary inbound and outbound routable protocol access between the low impact BES Cyber System(s) and the Cyber Asset(s) outside each asset containing low impact BES Cyber System(s). Care should be taken that electronic access to or between each asset is through the Cyber Asset(s) determined by the Responsible Entity to be performing electronic access controls at the centralized location. When permitting the inbound and outbound electronic access permissions using access control lists, the Responsible Entity could restrict communication(s) using source and destination addresses or ranges of addresses. Responsible Entities could also restrict communication(s) using ports or services based on the capability of the electronic access control, the low impact BES Cyber System(s), or the application(s).

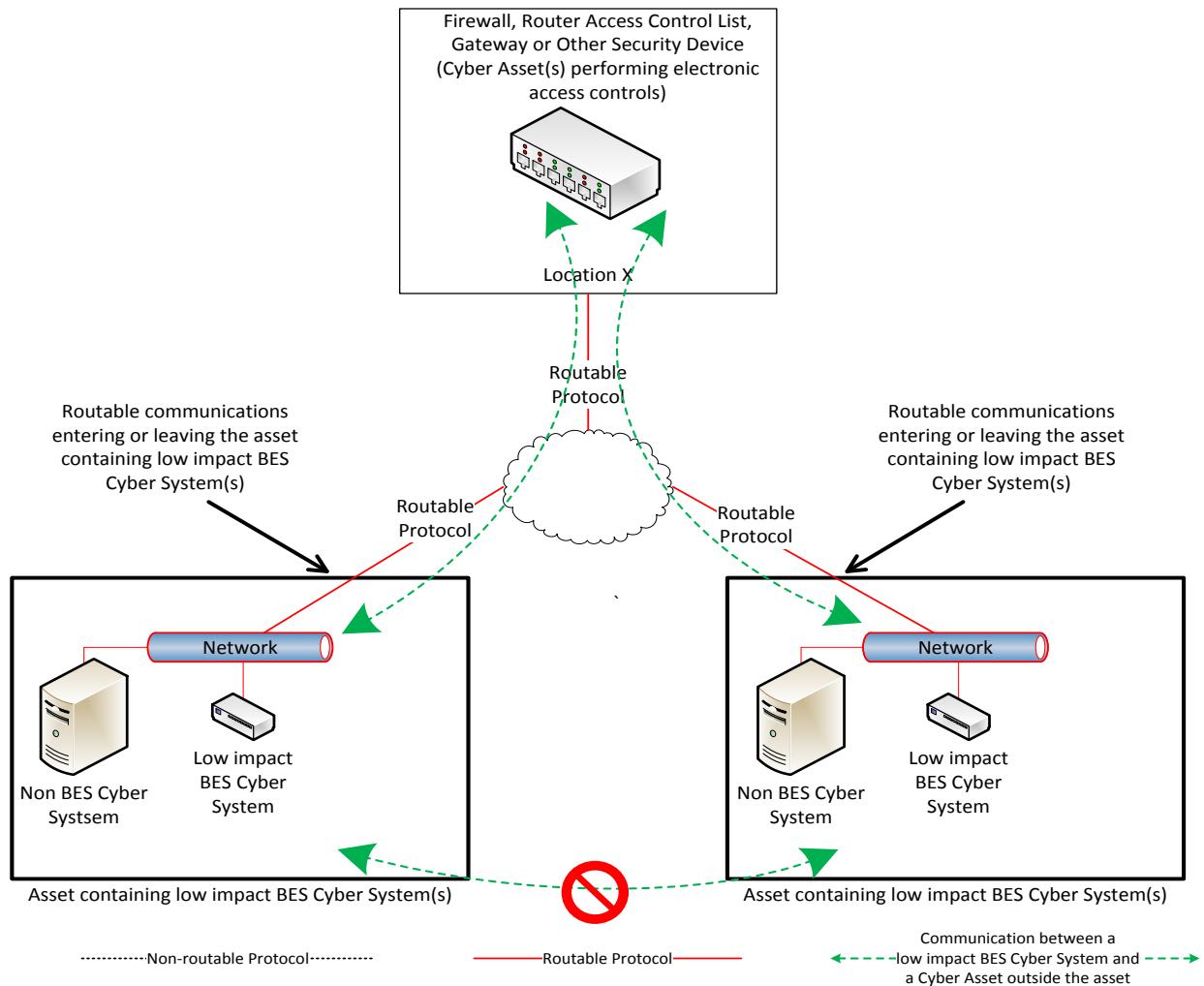

Reference Model 3

### Reference Model 4 – Uni-directional Gateway

The Responsible Entity may choose to utilize a uni-directional gateway as the electronic access control. The low impact BES Cyber System(s) is not accessible (data cannot flow into the low impact BES Cyber System) using the routable protocol entering the asset due to the implementation of a “one-way” (uni-directional) path for data to flow. The uni-directional gateway is configured to permit only the necessary outbound communications using the routable protocol communication leaving the asset.

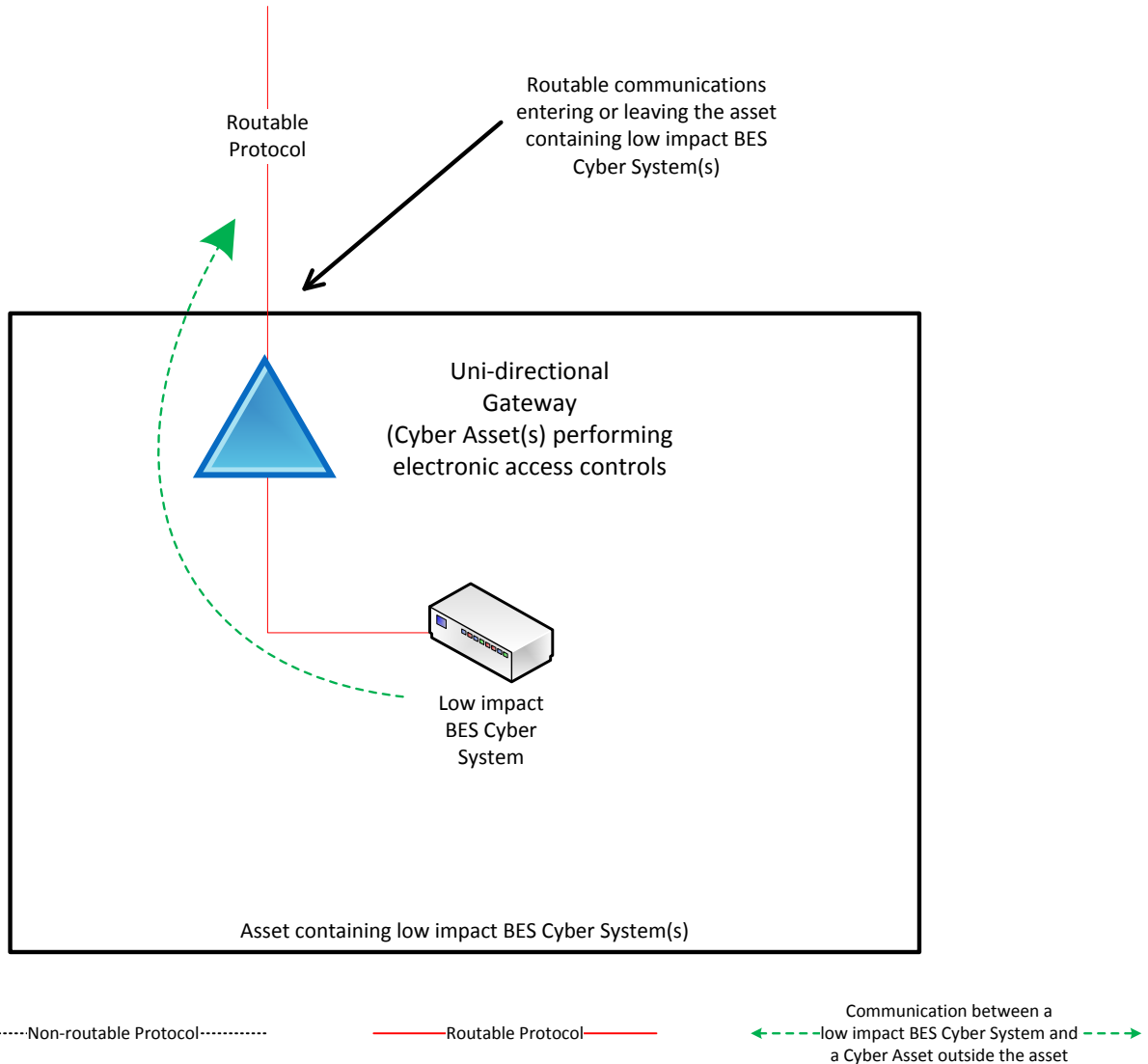

Reference Model 4

### Reference Model 5 – User Authentication

This reference model demonstrates that Responsible Entities have flexibility in choosing electronic access controls so long as the security objective of the requirement is met. The Responsible Entity may choose to utilize a non-BES Cyber Asset located at the asset containing the low impact BES Cyber System that requires authentication for communication from the Cyber Asset(s) outside the asset. This non-BES Cyber System performing the authentication permits only authenticated communication to connect to the low impact BES Cyber System(s), meeting the first half of the security objective to permit only necessary inbound electronic access. Additionally, the non-BES Cyber System performing authentication is configured such that it permits only necessary outbound communication meeting the second half of the security objective. Often, the outbound communications would be controlled in this network architecture by permitting no communication to be initiated from the low impact BES Cyber System. This configuration may be beneficial when the only communication to a device is for user-initiated interactive access.

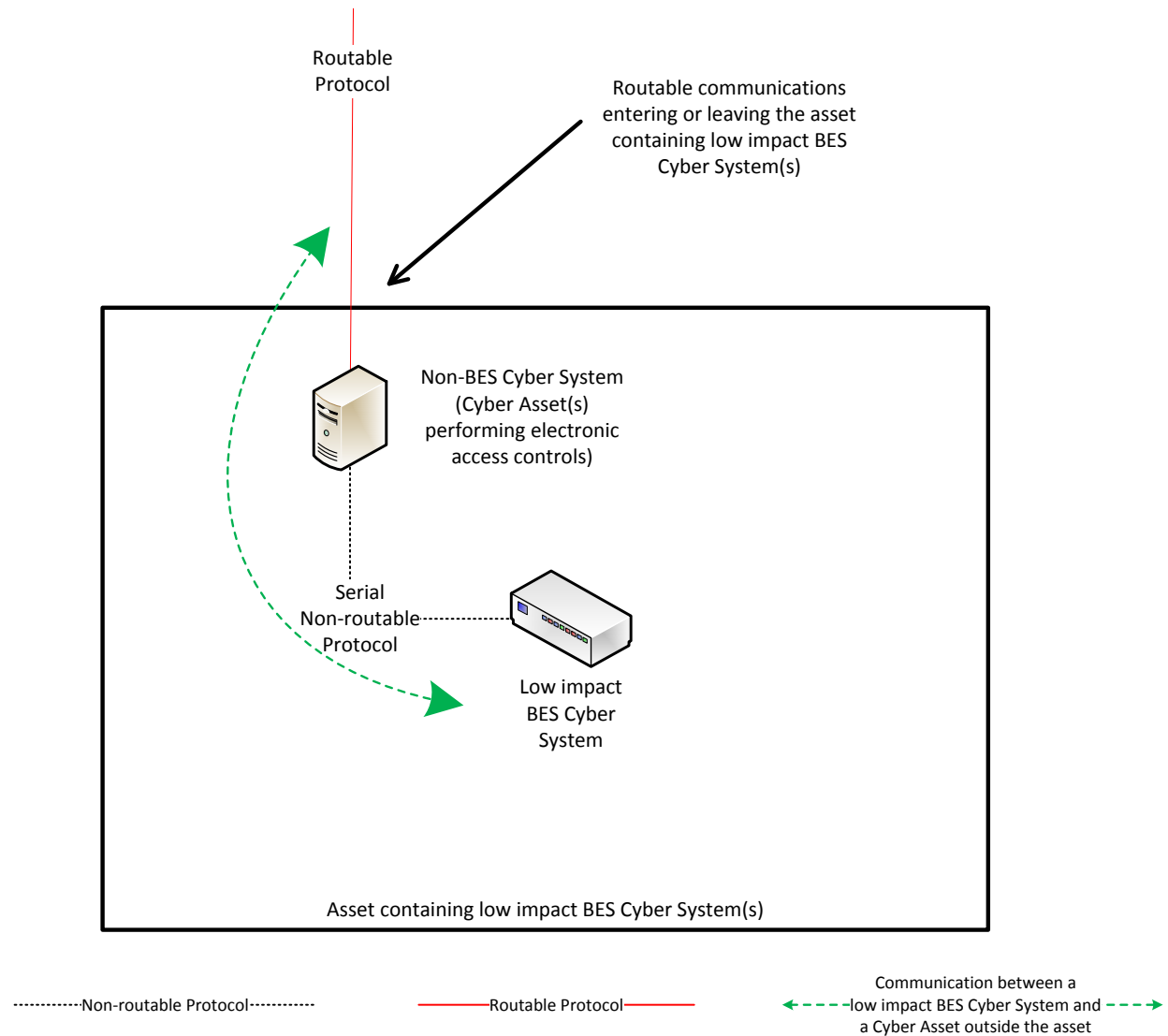

Reference Model 5

### Reference Model 6 – Indirect Access

In implementing its electronic access controls, the Responsible Entity may identify that it has indirect access between the low impact BES Cyber System and a Cyber Asset outside the asset containing the low impact BES Cyber System through a non-BES Cyber Asset located within the asset. This indirect access meets the criteria of having communication between the low impact BES Cyber System and a Cyber Asset outside the asset containing the low impact BES Cyber System. In this reference model, it is intended that the Responsible Entity implement electronic access controls that permit only necessary inbound and outbound electronic access to the low impact BES Cyber System. Consistent with the other reference models provided, the electronic access in this reference model is controlled using the security device that is restricting the communication that is entering or leaving the asset.

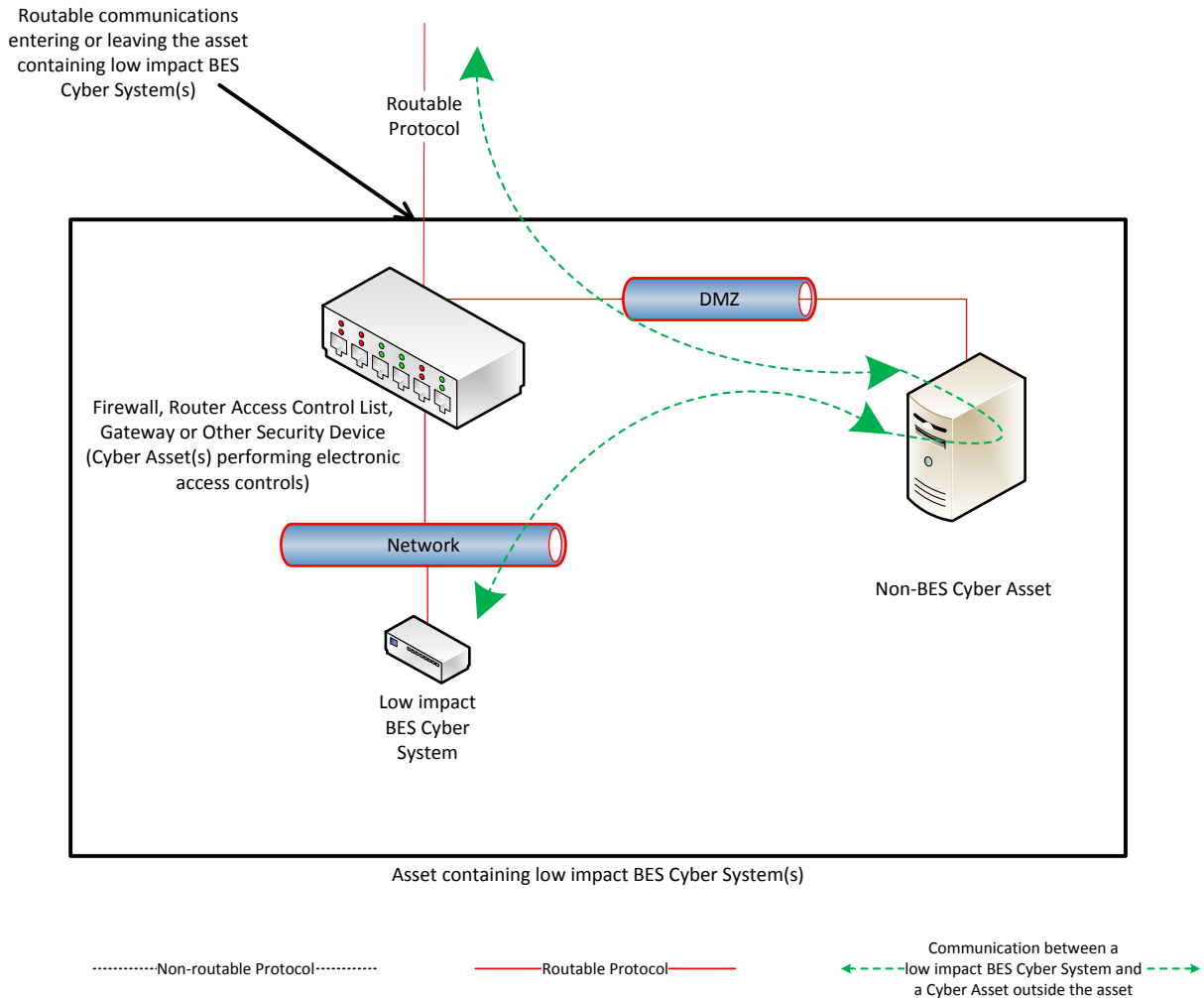

Reference Model 6



### Reference Model 7 – Electronic Access Controls at assets containing low impact BES Cyber Systems and ERC

In this reference model, there is both a routable protocol entering and leaving the asset containing the low impact BES Cyber System(s) that is used by Cyber Asset(s) outside the asset and External Routable Connectivity because there is at least one medium impact BES Cyber System and one low impact BES Cyber System within the asset using the routable protocol communications. The Responsible Entity may choose to leverage an interface on the medium impact Electronic Access Control or Monitoring Systems (EACMS) to provide electronic access controls for purposes of CIP-003. The EACMS is therefore performing multiple functions – as a medium impact EACMS and as implementing electronic access controls for an asset containing low impact BES Cyber Systems.

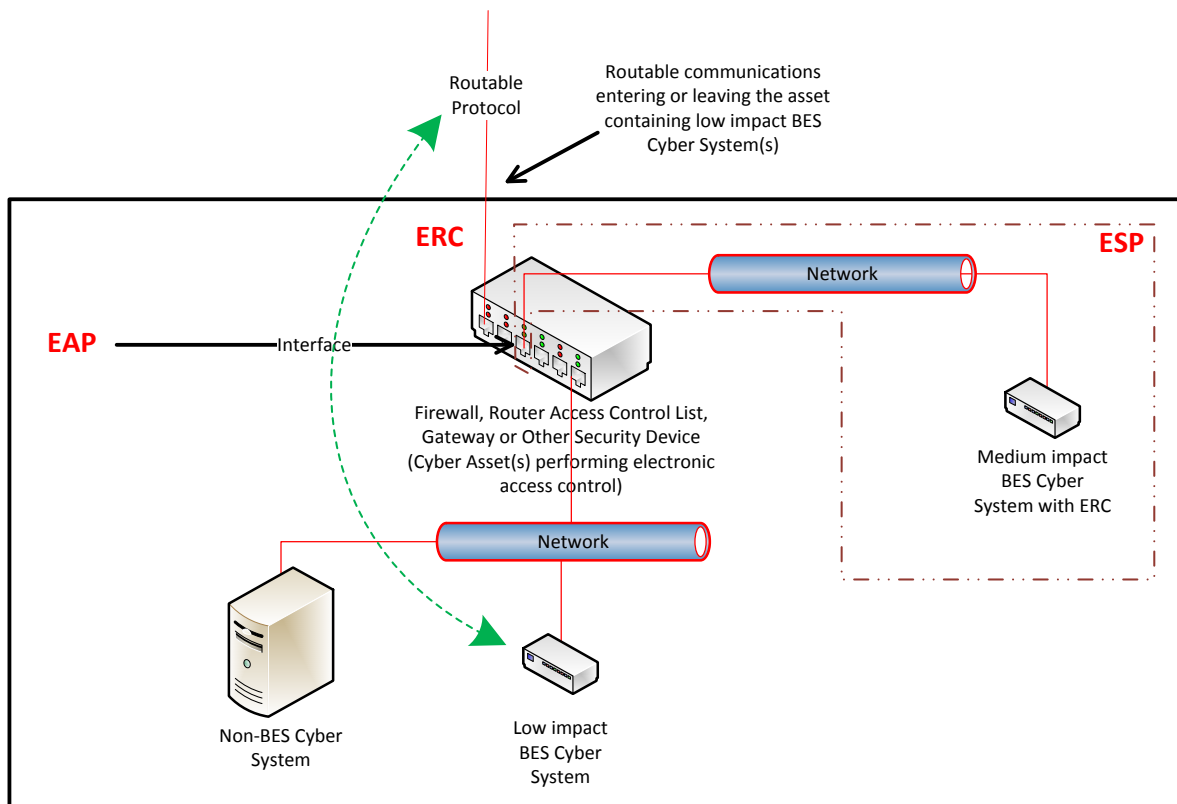

Asset containing low impact BES Cyber System(s) and medium impact BES Cyber System(s)



Reference Model 7

**Reference Model 8 – Physical Isolation and Serial Non-routable Communications – No Electronic Access Controls Required**

In this reference model, the criteria from Attachment 1, Section 3.1 requiring the implementation of electronic access controls are not met. This reference model demonstrates three concepts:

- 1) The physical isolation of the low impact BES Cyber System(s) from the routable protocol communication entering or leaving the asset containing the low impact BES Cyber System(s), commonly referred to as an 'air gap', mitigates the need to implement the required electronic access controls;
- 2) The communication to the low impact BES Cyber System from a Cyber Asset outside the asset containing the low impact BES Cyber System(s) using only a serial non-routable protocol where such communication is entering or leaving the asset mitigates the need to implement the required electronic access controls.
- 3) The routable protocol communication between the low impact BES Cyber System(s) and other Cyber Asset(s), such as the second low impact BES Cyber System depicted, may exist without needing to implement the required electronic access controls so long as the routable protocol communications never leaves the asset containing the low impact BES Cyber System(s).

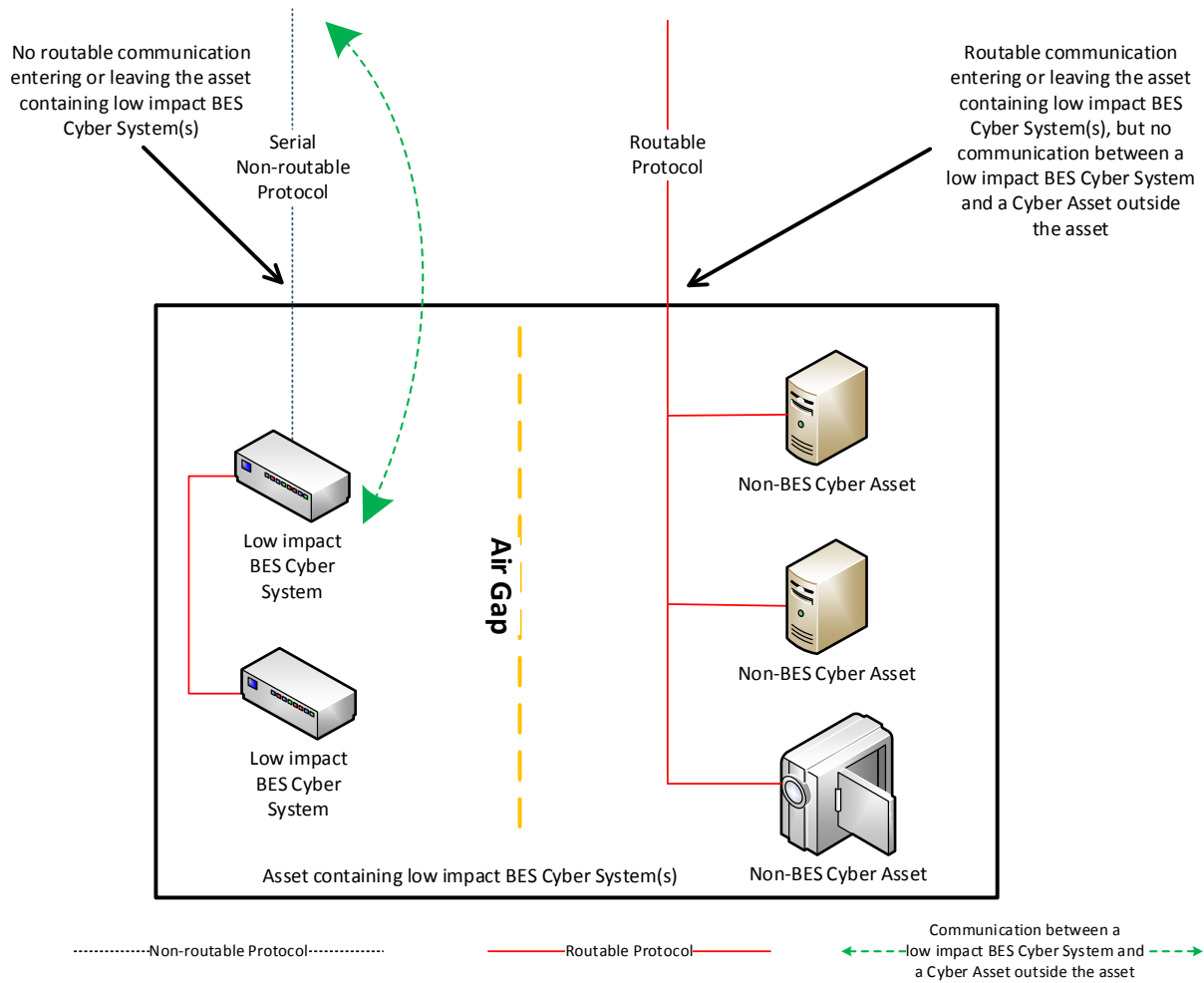

Reference Model 8

**Reference Model 9 – Logical Isolation - No Electronic Access Controls Required**

In this reference model, the criteria from Attachment 1, Section 3.1 requiring the implementation of electronic access controls are not met. The Responsible Entity has logically isolated the low impact BES Cyber System(s) from the routable protocol communication entering or leaving the asset containing low impact BES Cyber System(s). The logical network segmentation in this reference model permits no communication between a low impact BES Cyber System and a Cyber Asset outside the asset. Additionally, no indirect access exists because those non-BES Cyber Assets that are able to communicate outside the asset are strictly prohibited from communicating to the low impact BES Cyber System(s). The low impact BES Cyber System(s) is on an isolated network segment with logical controls preventing routable protocol communication into or out of the network containing the low impact BES Cyber System(s) and these communications never leave the asset using a routable protocol.

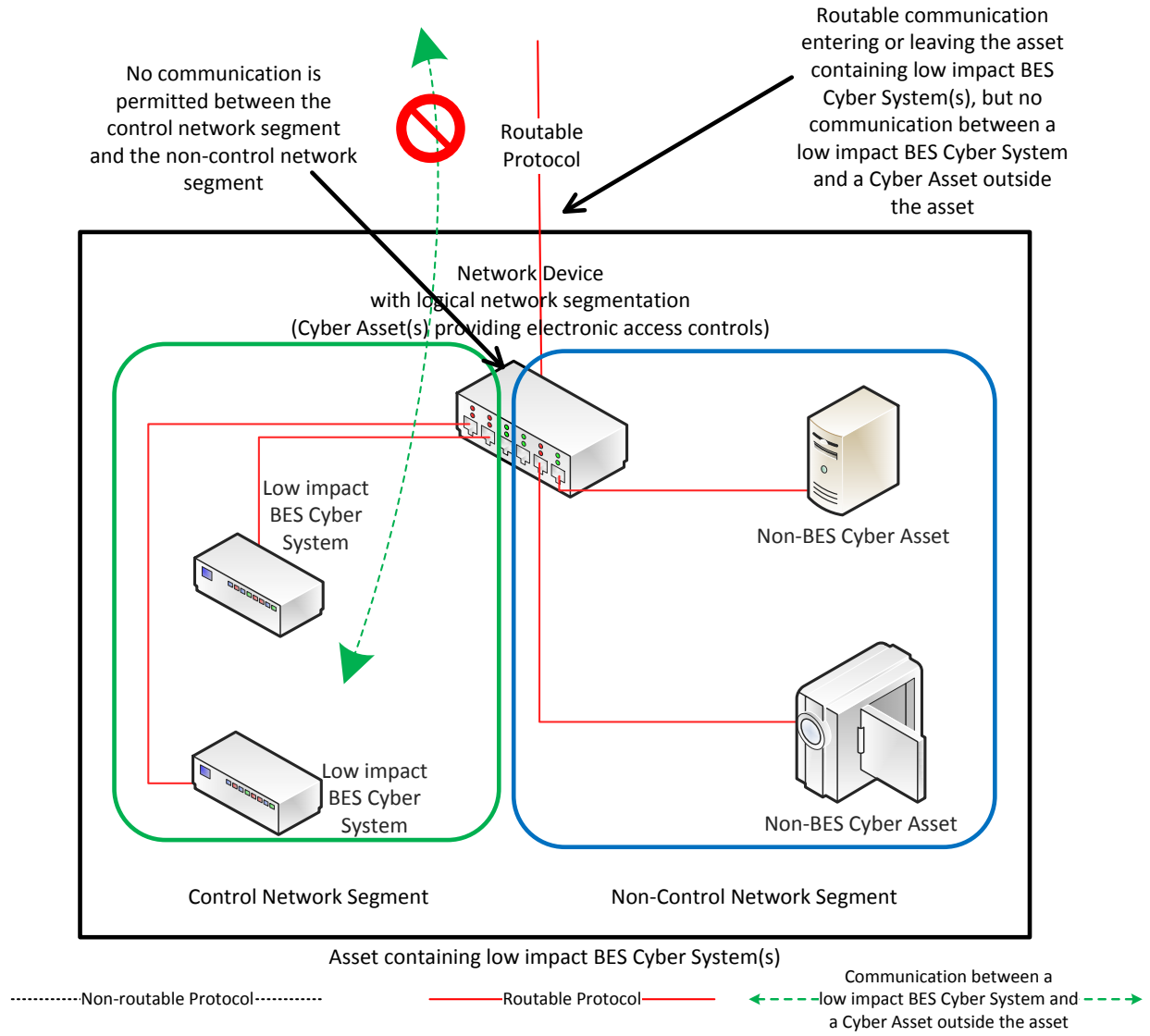

Reference Model 9

**Reference Model 10 - Serial Non-routable Communications Traversing an Isolated Channel on a Non-routable Transport Network – No Electronic Access Controls Required**

In this reference model, the criteria from Attachment 1, Section 3.1 requiring the implementation of electronic access controls are not met. This reference model depicts communication between a low impact BES Cyber System and a Cyber Asset outside the asset containing the low impact BES Cyber System over a serial non-routable protocol which is transported across a wide-area network using a protocol independent transport that may carry routable and non-routable communication such as a Time-Division Multiplexing (TDM) network, a Synchronous Optical Network (SONET), or a Multiprotocol Label Switching (MPLS) network. While there is routable protocol communication entering or leaving the asset containing low impact BES Cyber Systems(s) and there is communication between a low impact BES Cyber System and a Cyber Asset outside the asset, the communication between the low impact BES Cyber System and the Cyber Asset outside the asset is not using the routable protocol communication. This model is related to Reference Model 9 in that it relies on logical isolation to prohibit the communication between a low impact BES Cyber System and a Cyber Asset outside the asset from using a routable protocol.

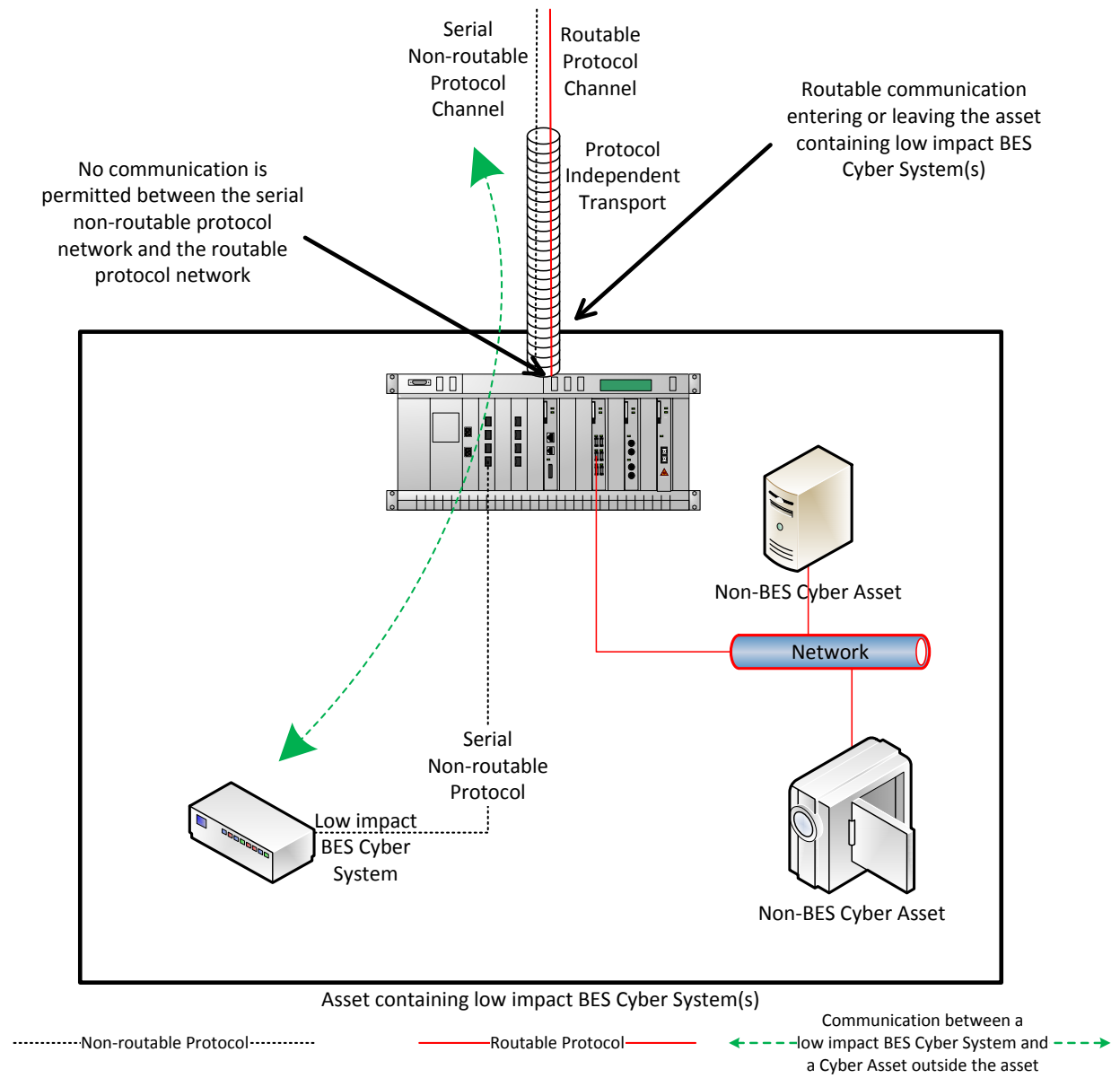

Reference Model 10

### Dial-up Connectivity

Dial-up Connectivity to a low impact BES Cyber System is set to dial out only (no auto-answer) to a preprogrammed number to deliver data. Incoming Dial-up Connectivity is to a dialback modem, a modem that must be remotely controlled by the control center or control room, has some form of access control, or the low impact BES Cyber System has access control.

### Insufficient Access Controls

Some examples of situations that would lack sufficient access controls to meet the intent of this requirement include:

- An asset has Dial-up Connectivity and a low impact BES Cyber System is reachable via an auto-answer modem that connects any caller to the Cyber Asset that has a default password. There is no practical access control in this instance.
- A low impact BES Cyber System has a wireless card on a public carrier that allows the BES Cyber System to be reachable via a public IP address. In essence, low impact BES Cyber Systems should not be accessible from the Internet and search engines such as Shodan.
- Dual-homing or multiple-network interface cards without disabling IP forwarding in the non-BES Cyber Asset within the DMZ to provide separation between the low impact BES Cyber System(s) and the external network would not meet the intent of “controlling” inbound and outbound electronic access assuming there was no other host-based firewall or other security devices on the non-BES Cyber Asset.

### Requirement R2, Attachment 1, Section 4 – Cyber Security Incident Response

The entity should have one or more documented Cyber Security Incident response plan(s) that include each of the topics listed in Section 4. If, in the normal course of business, suspicious activities are noted at an asset containing low impact BES Cyber System(s), the intent is for the entity to implement a Cyber Security Incident response plan that will guide the entity in responding to the incident and reporting the incident if it rises to the level of a Reportable Cyber Security Incident.

Entities are provided the flexibility to develop their Attachment 1, Section 4 Cyber Security Incident response plan(s) by asset or group of assets. The plans do not need to be on a per asset site or per low impact BES Cyber System basis. Entities can choose to use a single enterprise-wide plan to fulfill the obligations for low impact BES Cyber Systems.

The plan(s) must be tested once every 36 months. This is not an exercise per low impact BES Cyber Asset or per type of BES Cyber Asset but rather is an exercise of each incident response plan the entity created to meet this requirement. An actual Reportable Cyber Security Incident counts as an exercise as do other forms of tabletop exercises or drills. NERC-led exercises such as GridEx participation would also count as an exercise provided the entity’s response plan is followed. The intent of the requirement is for entities to keep the Cyber Security Incident response plan(s) current, which includes updating the plan(s), if needed, within 180 days following a test or an actual incident.

For low impact BES Cyber Systems, the only portion of the definition of Cyber Security Incident that would apply is, “A malicious act or suspicious event that disrupts, or was an attempt to



disrupt, the operation of a BES Cyber System.” The other portion of that definition is not to be used to require ESPs and PSPs for low impact BES Cyber Systems.

### **Requirement R2, Attachment 1, Section 5 – Transient Cyber Assets and Removable Media Malicious Code Risk Mitigation**

Most BES Cyber Assets and BES Cyber Systems are isolated from external public or untrusted networks, and therefore Transient Cyber Assets and Removable Media are needed to transport files to and from secure areas to maintain, monitor, or troubleshoot critical systems. Transient Cyber Assets and Removable Media are a potential means for cyber-attack. To protect the BES Cyber Assets and BES Cyber Systems, CIP-003 Requirement R2, Attachment 1, Section 5 requires Responsible Entities to document and implement a plan for how they will mitigate the risk of malicious code introduction to low impact BES Cyber Systems from Transient Cyber Assets and Removable Media. The approach of defining a plan allows the Responsible Entity to document processes that are supportable within its organization and in alignment with its change management processes.

Transient Cyber Assets can be one of many types of devices from a specially-designed device for maintaining equipment in support of the BES to a platform such as a laptop, desktop, or tablet that may interface with or run applications that support BES Cyber Systems and is capable of transmitting executable code to the BES Cyber Asset(s) or BES Cyber System(s). Note: Cyber Assets connected to a BES Cyber System for less than 30 days due to an unplanned removal, such as premature failure, are not intended to be identified as Transient Cyber Assets. Removable Media subject to this requirement include, among others, floppy disks, compact disks, USB flash drives, external hard drives, and other flash memory cards/drives that contain nonvolatile memory.

Examples of these temporarily connected devices include, but are not limited to:

- Diagnostic test equipment;
- Equipment used for BES Cyber System maintenance; or
- Equipment used for BES Cyber System configuration.

To meet the objective of mitigating risks associated with the introduction of malicious code at low impact BES Cyber Systems, Section 5 specifies the capabilities and possible security methods available to Responsible Entities based upon asset type and ownership.

With the list of options provided in Attachment 1, the entity has the discretion to use the option(s) that is most appropriate. This includes documenting its approach for how and when the entity reviews the Transient Cyber Asset under its control or under the control of parties other than the Responsible Entity. The entity should avoid implementing a security function that jeopardizes reliability by taking actions that would negatively impact the performance or support of the Transient Cyber Asset or BES Cyber Asset.

### Malicious Code Risk Mitigation

The terms “mitigate”, “mitigating”, and “mitigation” are used in Section 5 in Attachment 1 to address the risks posed by malicious code when connecting Transient Cyber Assets and Removable Media to BES Cyber Systems. Mitigation is intended to mean that entities reduce security risks presented by connecting the Transient Cyber Asset or Removable Media. When determining the method(s) to mitigate the introduction of malicious code, it is not intended for entities to perform and document a formal risk assessment associated with the introduction of malicious code.

### Per Transient Cyber Asset Capability

As with other CIP standards, the requirements are intended for an entity to use the method(s) that the system is capable of performing. The use of “per Transient Cyber Asset capability” is to eliminate the need for a Technical Feasibility Exception when it is understood that the device cannot use a method(s). For example, for malicious code, many types of appliances are not capable of implementing antivirus software; therefore, because it is not a capability of those types of devices, implementation of the antivirus software would not be required for those devices.

### **Requirement R2, Attachment 1, Section 5.1 - Transient Cyber Asset(s) Managed by the Responsible Entity**

For Transient Cyber Assets and Removable Media that are connected to both low impact and medium/high impact BES Cyber Systems, entities must be aware of the differing levels of requirements and manage these assets under the program that matches the highest impact level to which they will connect.

**Section 5.1:** Entities are to document and implement their plan(s) to mitigate malicious code through the use of one or more of the protective measures listed, based on the capability of the Transient Cyber Asset.

The Responsible Entity has the flexibility to apply the selected method(s) to meet the objective of mitigating the introductions of malicious code either in an on-going or in an on-demand manner. An example of managing a device in an on-going manner is having the antivirus solution for the device managed as part of an end-point security solution with current signature or pattern updates, regularly scheduled systems scans, etc. In contrast, for devices that are used infrequently and the signatures or patterns are not kept current, the entity may manage those devices in an on-demand manner by requiring an update to the signatures or patterns and a scan of the device before the device is connected to ensure that it is free of malicious code.

Selecting management in an on-going or on-demand manner is not intended to imply that the control has to be verified at every single connection. For example, if the device is managed in an on-demand manner, but will be used to perform maintenance on several BES Cyber Asset(s), the Responsible Entity may choose to document that the Transient Cyber Asset has been updated before being connected as a Transient Cyber Asset for the first use of that maintenance work. The intent is not to require a log documenting each connection of a Transient Cyber Asset to a BES Cyber Asset.

The following is additional discussion of the methods to mitigate the introduction of malicious code.

- Antivirus software, including manual or managed updates of signatures or patterns, provides flexibility to manage Transient Cyber Asset(s) by deploying antivirus or endpoint security tools that maintain a scheduled update of the signatures or patterns. Also, for devices that do not regularly connect to receive scheduled updates, entities may choose to update the signatures or patterns and scan the Transient Cyber Asset prior to connection to ensure no malicious software is present.
- Application whitelisting is a method of authorizing only the applications and processes that are necessary on the Transient Cyber Asset. This reduces the risk that malicious software could execute on the Transient Cyber Asset and impact the BES Cyber Asset or BES Cyber System.
- When using methods other than those listed, entities need to document how the other method(s) meet the objective of mitigating the risk of the introduction of malicious code.

If malicious code is discovered on the Transient Cyber Asset, it must be mitigated prior to connection to a BES Cyber System to prevent the malicious code from being introduced into the BES Cyber System. An entity may choose to not connect the Transient Cyber Asset to a BES Cyber System to prevent the malicious code from being introduced into the BES Cyber System. Entities should also consider whether the detected malicious code is a Cyber Security Incident.

### **Requirement R2, Attachment 1, Section 5.2 - Transient Cyber Asset(s) Managed by a Party Other than the Responsible Entity**

Section 5 also recognizes the lack of direct control over Transient Cyber Assets that are managed by parties other than the Responsible Entity. This lack of control, however, does not obviate the Responsible Entity's responsibility to ensure that methods have been deployed to mitigate the introduction of malicious code to low impact BES Cyber System(s) from Transient Cyber Assets it does not manage. Section 5 requires entities to review the other party's security practices with respect to Transient Cyber Assets to help meet the objective of the requirement. The use of "prior to connecting the Transient Cyber Assets" is intended to ensure that the Responsible Entity conducts the review before the first connection of the Transient Cyber Asset to help meet the objective to mitigate the introduction of malicious code. The SDT does not intend for the Responsible Entity to conduct a review for every single connection of that Transient Cyber Asset once the Responsible Entity has established the Transient Cyber Asset is meeting the security objective. The intent is to not require a log documenting each connection of a Transient Cyber Asset to a BES Cyber Asset.

To facilitate these controls, Responsible Entities may execute agreements with other parties to provide support services to BES Cyber Systems and BES Cyber Assets that may involve the use of Transient Cyber Assets. Entities may consider using the Department of Energy Cybersecurity Procurement Language for Energy Delivery dated April 2014.<sup>1</sup> Procurement language may unify

---

<sup>1</sup> <http://www.energy.gov/oe/downloads/cybersecurity-procurement-language-energy-delivery-april-2014>

the other party and entity actions supporting the BES Cyber Systems and BES Cyber Assets. CIP program attributes may be considered including roles and responsibilities, access controls, monitoring, logging, vulnerability, and patch management along with incident response and back up recovery may be part of the other party's support. Entities may consider the "General Cybersecurity Procurement Language" and "The Supplier's Life Cycle Security Program" when drafting Master Service Agreements, Contracts, and the CIP program processes and controls.

**Section 5.2.1:** Entities are to document and implement their process(es) to mitigate the introduction of malicious code through the use of one or more of the protective measures listed.

- Review the use of antivirus software and signature or pattern levels to ensure that the level is adequate to the Responsible Entity to mitigate the risk of malicious software being introduced to an applicable system.
- Review the antivirus or endpoint security processes of the other party to ensure that their processes are adequate to the Responsible Entity to mitigate the risk of introducing malicious software to an applicable system.
- Review the use of application whitelisting used by the other party to mitigate the risk of introducing malicious software to an applicable system.
- Review the use of live operating systems or software executable only from read-only media to ensure that the media is free from malicious software itself. Entities should review the processes to build the read-only media as well as the media itself.
- Review system hardening practices used by the other party to ensure that unnecessary ports, services, applications, etc. have been disabled or removed. This method intends to reduce the attack surface on the Transient Cyber Asset and reduce the avenues by which malicious software could be introduced.

**Section 5.2.2:** The intent of this section is to ensure that after conducting the selected review from Section 5.2.1, if there are deficiencies identified, actions mitigating the risk of the introduction of malicious code to low impact BES Cyber Systems must be completed prior to connecting the device(s) to an applicable system.

### **Requirement R2, Attachment 1, Section 5.3 - Removable Media**

Entities have a high level of control for Removable Media that are going to be connected to their BES Cyber Assets.

**Section 5.3:** Entities are to document and implement their process(es) to mitigate the introduction of malicious code through the use of one or more method(s) to detect malicious code on the Removable Media before it is connected to a BES Cyber Asset. When using the method(s) to detect malicious code, it is expected to occur from a system that is not part of the BES Cyber System to reduce the risk of propagating malicious code into the BES Cyber System

network or onto one of the BES Cyber Assets. If malicious code is discovered, it must be removed or mitigated to prevent it from being introduced into the BES Cyber Asset or BES Cyber System. Entities should also consider whether the detected malicious code is a Cyber Security Incident. Frequency and timing of the methods used to detect malicious code were intentionally excluded from the requirement because there are multiple timing scenarios that can be incorporated into a plan to mitigate the risk of malicious code. The SDT does not intend to obligate a Responsible Entity to conduct a review for every single connection of Removable Media, but rather to implement its plan(s) in a manner that protects all BES Cyber Systems where Removable Media may be used. The intent is to not require a log documenting each connection of Removable Media to a BES Cyber Asset.

As a method to detect malicious code, entities may choose to use Removable Media with on-board malicious code detection tools. For these tools, the Removable Media are still used in conjunction with a Cyber Asset to perform the detection. For Section 5.3.1, the Cyber Asset used to perform the malicious code detection must be outside of the BES Cyber System.

### **Requirement R3:**

The intent of CIP-003-8, Requirement R3 is effectively unchanged since prior versions of the standard. The specific description of the CIP Senior Manager has now been included as a defined term rather than clarified in the Reliability Standard itself to prevent any unnecessary cross-reference to this standard. It is expected that the CIP Senior Manager will play a key role in ensuring proper strategic planning, executive/board-level awareness, and overall program governance.

### **Requirement R4:**

As indicated in the rationale for CIP-003-8, Requirement R4, this requirement is intended to demonstrate a clear line of authority and ownership for security matters. The intent of the SDT was not to impose any particular organizational structure, but, rather, the intent is to afford the Responsible Entity significant flexibility to adapt this requirement to its existing organizational structure. A Responsible Entity may satisfy this requirement through a single delegation document or through multiple delegation documents. The Responsible Entity can make use of the delegation of the delegation authority itself to increase the flexibility in how this applies to its organization. In such a case, delegations may exist in numerous documentation records as long as the collection of these documentation records shows a clear line of authority back to the CIP Senior Manager. In addition, the CIP Senior Manager could also choose not to delegate any authority and meet this requirement without such delegation documentation.

The Responsible Entity must keep its documentation of the CIP Senior Manager and any delegations up-to-date. This is to ensure that individuals do not assume any undocumented authority. However, delegations do not have to be re-instated if the individual who delegated the task changes roles or the individual is replaced. For instance, assume that John Doe is named the CIP Senior Manager and he delegates a specific task to the Substation Maintenance Manager. If John Doe is replaced as the CIP Senior Manager, the CIP Senior Manager documentation must be updated within the specified timeframe, but the existing delegation to

the Substation Maintenance Manager remains in effect as approved by the previous CIP Senior Manager, John Doe.

### **Rationale:**

During development of this standard, text boxes were embedded within the standard to explain the rationale for various parts of the standard. Upon BOT approval, the text from the rationale text boxes was moved to this section.

### **Rationale for Requirement R1:**

One or more security policies enable effective implementation of the requirements of the cyber security Reliability Standards. The purpose of policies is to provide a management and governance foundation for all requirements that apply to a Responsible Entity's BES Cyber Systems. The Responsible Entity can demonstrate through its policies that its management supports the accountability and responsibility necessary for effective implementation of the requirements.

Annual review and approval of the cyber security policies ensures that the policies are kept-up-to-date and periodically reaffirms management's commitment to the protection of its BES Cyber Systems.

### **Rationale for Requirement R2:**

In response to FERC Order No. 791, Requirement R2 requires entities to develop and implement cyber security plans to meet specific security control objectives for assets containing low impact BES Cyber System(s). The cyber security plan(s) covers five subject matter areas: (1) cyber security awareness; (2) physical security controls; (3) electronic access controls; (4) Cyber Security Incident response; and (5) Transient Cyber Asset and Removable Media Malicious Code Risk Mitigation. This plan(s), along with the cyber security policies required under Requirement R1, Part 1.2, provides a framework for operational, procedural, and technical safeguards for low impact BES Cyber Systems.

Considering the varied types of low impact BES Cyber Systems across the BES, Attachment 1 provides Responsible Entities flexibility on how to apply the security controls to meet the security objectives. Additionally, because many Responsible Entities have multiple-impact rated BES Cyber Systems, nothing in the requirement prohibits entities from using their high and medium impact BES Cyber System policies, procedures, and processes to implement security controls required for low impact BES Cyber Systems, as detailed in Requirement R2, Attachment 1.

Responsible Entities will use their identified assets containing low impact BES Cyber System(s) (developed pursuant to CIP-002) to substantiate the sites or locations associated with low impact BES Cyber System(s). However, there is no requirement or compliance expectation for Responsible Entities to maintain a list(s) of individual low impact BES Cyber System(s) and their associated cyber assets or to maintain a list of authorized users.

### **Rationale for Modifications to Sections 2 and 3 of Attachment 1 (Requirement R2):**

Requirement R2 mandates that entities develop and implement one or more cyber security plan(s) to meet specific security objectives for assets containing low impact BES Cyber System(s). In Paragraph 73 of FERC Order No. 822, the Commission directed NERC to modify "...the Low Impact External Routable Connectivity definition to reflect the commentary in the Guidelines and Technical Basis section of CIP-003-6...to provide needed clarity to the definition

and eliminate ambiguity surrounding the term ‘direct’ as it is used in the proposed definition...within one year of the effective date of this Final Rule.”

The revisions to Section 3 incorporate select language from the LERC definition into Attachment 1 and focus the requirement on implementing electronic access controls for asset(s) containing low impact BES Cyber System(s). This change requires the Responsible Entity to permit only necessary inbound and outbound electronic access when using a routable protocol entering or leaving the asset between low impact BES Cyber System(s) and a Cyber Asset(s) outside the asset containing low impact BES Cyber system(s). When this communication is present, Responsible Entities are required to implement electronic access controls unless that communication meets the following exclusion language (previously in the definition of LERC) contained in romanette (iii): “not used for time-sensitive protection or control functions between intelligent electronic devices (e.g. communications using protocol IEC TR-61850-90-5 R-GOOSE)”.

The revisions to Section 2 of Attachment 1 complement the revisions to Section 3; consequently, the requirement now mandates the Responsible Entity control physical access to “the Cyber Asset(s), as specified by the Responsible Entity, that provide electronic access control(s) implemented for Section 3.1, if any.” The focus on electronic access controls rather than on the Low Impact BES Cyber System Electronic Access Points (LEAPs) eliminates the need for LEAPs.

Given these revisions to Sections 2 and 3, the NERC Glossary terms: Low Impact External Routable Connectivity (LERC) and Low Impact BES Cyber System Electronic Access Point (LEAP) will be retired.

### **Rationale for Section 5 of Attachment 1 (Requirement R2):**

Requirement R2 mandates that entities develop and implement one or more cyber security plan(s) to meet specific security objectives for assets containing low impact BES Cyber System(s). In Paragraph 32 of FERC Order No. 822, the Commission directed NERC to “...provide mandatory protection for transient devices used at Low Impact BES Cyber Systems based on the risk posed to bulk electric system reliability.” Transient devices are potential vehicles for introducing malicious code into low impact BES Cyber Systems. Section 5 of Attachment 1 is intended to mitigate the risk of malware propagation to the BES through low impact BES Cyber Systems by requiring entities to develop and implement one or more plan(s) to address the risk. The cyber security plan(s) along with the cyber security policies required under Requirement R1, Part 1.2, provide a framework for operational, procedural, and technical safeguards for low impact BES Cyber Systems.

### **Rationale for Requirement R3:**

The identification and documentation of the single CIP Senior Manager ensures that there is clear authority and ownership for the CIP program within an organization, as called for in Blackout Report Recommendation 43. The language that identifies CIP Senior Manager responsibilities is included in the Glossary of Terms used in NERC Reliability Standards so that it may be used across the body of CIP standards without an explicit cross-reference.



FERC Order No. 706, Paragraph 296, requests consideration of whether the single senior manager should be a corporate officer or equivalent. As implicated through the defined term, the senior manager has “the overall authority and responsibility for leading and managing implementation of the requirements within this set of standards” which ensures that the senior manager is of sufficient position in the Responsible Entity to ensure that cyber security receives the prominence that is necessary. In addition, given the range of business models for responsible entities, from municipal, cooperative, federal agencies, investor owned utilities, privately owned utilities, and everything in between, the SDT believes that requiring the CIP Senior Manager to be a “corporate officer or equivalent” would be extremely difficult to interpret and enforce on a consistent basis.

### **Rationale for Requirement R4:**

The intent of the requirement is to ensure clear accountability within an organization for certain security matters. It also ensures that delegations are kept up-to-date and that individuals do not assume undocumented authority.

In FERC Order No. 706, Paragraphs 379 and 381, the Commission notes that Recommendation 43 of the 2003 Blackout Report calls for “clear lines of authority and ownership for security matters.” With this in mind, the Standard Drafting Team has sought to provide clarity in the requirement for delegations so that this line of authority is clear and apparent from the documented delegations.

## A. Introduction

1. **Title:** Cyber Security — Security Management Controls
2. **Number:** CIP-003-78
3. **Purpose:** To specify consistent and sustainable security management controls that establish responsibility and accountability to protect BES Cyber Systems against compromise that could lead to misoperation or instability in the Bulk Electric System (BES).

### 4. Applicability:

**4.1. Functional Entities:** For the purpose of the requirements contained herein, the following list of functional entities will be collectively referred to as “Responsible Entities.” For requirements in this standard where a specific functional entity or subset of functional entities are the applicable entity or entities, the functional entity or entities are specified explicitly.

#### 4.1.1. Balancing Authority

**4.1.2. Distribution Provider** that owns one or more of the following Facilities, systems, and equipment for the protection or restoration of the BES:

**4.1.2.1.** Each underfrequency Load shedding (UFLS) or undervoltage Load shedding (UVLS) system that:

**4.1.2.1.1.** is part of a Load shedding program that is subject to one or more requirements in a NERC or Regional Reliability Standard; and

**4.1.2.1.2.** performs automatic Load shedding under a common control system owned by the Responsible Entity, without human operator initiation, of 300 MW or more.

**4.1.2.2.** Each ~~Special Protection System (SPS) or~~ Remedial Action Scheme (RAS) where the ~~SPS or~~ RAS is subject to one or more requirements in a NERC or Regional Reliability Standard.

**4.1.2.3.** Each Protection System (excluding UFLS and UVLS) that applies to Transmission where the Protection System is subject to one or more requirements in a NERC or Regional Reliability Standard.

**4.1.2.4.** Each Cranking Path and group of Elements meeting the initial switching requirements from a Blackstart Resource up to and including the first interconnection point of the starting station service of the next generation unit(s) to be started.

#### 4.1.3. Generator Operator

#### 4.1.4. Generator Owner

#### ~~4.1.5. Interchange Coordinator or Interchange Authority~~

**4.1.6.4.1.5. Reliability Coordinator**

**4.1.7.4.1.6. Transmission Operator**

**4.1.8.4.1.7. Transmission Owner**

**4.2. Facilities:** For the purpose of the requirements contained herein, the following Facilities, systems, and equipment owned by each Responsible Entity in Section 4.1 above are those to which these requirements are applicable. For requirements in this standard where a specific type of Facilities, system, or equipment or subset of Facilities, systems, and equipment are applicable, these are specified explicitly.

**4.2.1. Distribution Provider:** One or more of the following Facilities, systems and equipment owned by the Distribution Provider for the protection or restoration of the BES:

**4.2.1.1.** Each UFLS or UVLS System that:

**4.2.1.1.1.** is part of a Load shedding program that is subject to one or more requirements in a NERC or Regional Reliability Standard; and

**4.2.1.1.2.** performs automatic Load shedding under a common control system owned by the Responsible Entity, without human operator initiation, of 300 MW or more.

**4.2.1.2.** Each ~~SPS or~~ RAS where the ~~SPS or~~ RAS is subject to one or more requirements in a NERC or Regional Reliability Standard.

**4.2.1.3.** Each Protection System (excluding UFLS and UVLS) that applies to Transmission where the Protection System is subject to one or more requirements in a NERC or Regional Reliability Standard.

**4.2.1.4.** Each Cranking Path and group of Elements meeting the initial switching requirements from a Blackstart Resource up to and including the first interconnection point of the starting station service of the next generation unit(s) to be started.

**4.2.2. Responsible Entities listed in 4.1 other than Distribution Providers:**

All BES Facilities.

**4.2.3. Exemptions:** The following are exempt from Standard CIP-003-78:

**4.2.3.1.** Cyber Assets at Facilities regulated by the Canadian Nuclear Safety Commission.

**4.2.3.2.** Cyber Assets associated with communication networks and data communication links between discrete Electronic Security Perimeters (ESPs).

**4.2.3.3.** The systems, structures, and components that are regulated by the Nuclear Regulatory Commission under a cyber security plan pursuant to 10 C.F.R. Section 73.54.

**4.2.3.4.** For Distribution Providers, the systems and equipment that are not included in section 4.2.1 above.

**5. Effective Dates:**

See Implementation Plan for CIP-003-78.

**6. Background:**

Standard CIP-003 exists as part of a suite of CIP Standards related to cyber security, which require the initial identification and categorization of BES Cyber Systems and require organizational, operational, and procedural controls to mitigate risk to BES Cyber Systems.

The term policy refers to one or a collection of written documents that are used to communicate the Responsible Entities' management goals, objectives and expectations for how the Responsible Entity will protect its BES Cyber Systems. The use of policies also establishes an overall governance foundation for creating a culture of security and compliance with laws, regulations, and standards.

The term documented processes refers to a set of required instructions specific to the Responsible Entity and to achieve a specific outcome. This term does not imply any naming or approval structure beyond what is stated in the requirements. An entity should include as much as it believes necessary in its documented processes, but it must address the applicable requirements.

The terms program and plan are sometimes used in place of documented processes where it makes sense and is commonly understood. For example, documented processes describing a response are typically referred to as plans (i.e., incident response plans and recovery plans). Likewise, a security plan can describe an approach involving multiple procedures to address a broad subject matter.

Similarly, the term program may refer to the organization's overall implementation of its policies, plans, and procedures involving a subject matter. Examples in the standards include the personnel risk assessment program and the personnel training program. The full implementation of the CIP Cyber Security Reliability Standards could also be referred to as a program. However, the terms program and plan do not imply any additional requirements beyond what is stated in the standards.

Responsible Entities can implement common controls that meet requirements for multiple high, medium, and low impact BES Cyber Systems. For example, a single cyber security awareness program could meet the requirements across multiple BES Cyber Systems.

Measures provide examples of evidence to show documentation and implementation of the requirement. These measures serve to provide guidance to entities in acceptable records of compliance and should not be viewed as an all-inclusive list.

Throughout the standards, unless otherwise stated, bulleted items in the requirements and measures are items that are linked with an “or,” and numbered items are items that are linked with an “and.”

Many references in the Applicability section use a threshold of 300 MW for UFLS and UVLS. This particular threshold of 300 MW for UVLS and UFLS was provided in Version 1 of the CIP Cyber Security Standards. The threshold remains at 300 MW since it is specifically addressing UVLS and UFLS, which are last ditch efforts to save the BES. A review of UFLS tolerances defined within Regional Reliability Standards for UFLS program requirements to date indicates that the historical value of 300 MW represents an adequate and reasonable threshold value for allowable UFLS operational tolerances.

## B. Requirements and Measures

- R1.** Each Responsible Entity shall review and obtain CIP Senior Manager approval at least once every 15 calendar months for one or more documented cyber security policies that collectively address the following topics: *[Violation Risk Factor: Medium] [Time Horizon: Operations Planning]*
- 1.1.** For its high impact and medium impact BES Cyber Systems, if any:
    - 1.1.1.** Personnel and training (CIP-004);
    - 1.1.2.** Electronic Security Perimeters (CIP-005) including Interactive Remote Access;
    - 1.1.3.** Physical security of BES Cyber Systems (CIP-006);
    - 1.1.4.** System security management (CIP-007);
    - 1.1.5.** Incident reporting and response planning (CIP-008);
    - 1.1.6.** Recovery plans for BES Cyber Systems (CIP-009);
    - 1.1.7.** Configuration change management and vulnerability assessments (CIP-010);
    - 1.1.8.** Information protection (CIP-011); and
    - 1.1.9.** Declaring and responding to CIP Exceptional Circumstances.
  - 1.2.** For its assets identified in CIP-002 containing low impact BES Cyber Systems, if any:
    - 1.2.1.** Cyber security awareness;
    - 1.2.2.** Physical security controls;
    - 1.2.3.** Electronic access controls;
    - 1.2.4.** Cyber Security Incident response;
    - 1.2.5.** Transient Cyber Assets and Removable Media malicious code risk mitigation; and
    - 1.2.6.** Declaring and responding to CIP Exceptional Circumstances.
- M1.** Examples of evidence may include, but are not limited to, policy documents; revision history, records of review, or workflow evidence from a document management system that indicate review of each cyber security policy at least once every 15 calendar months; and documented approval by the CIP Senior Manager for each cyber security policy.
- R2.** Each Responsible Entity with at least one asset identified in CIP-002 containing low impact BES Cyber Systems shall implement one or more documented cyber security plan(s) for its low impact BES Cyber Systems that include the sections in Attachment 1. *[Violation Risk Factor: Lower] [Time Horizon: Operations Planning]*

Note: An inventory, list, or discrete identification of low impact BES Cyber Systems or their BES Cyber Assets is not required. Lists of authorized users are not required.

- M2.** Evidence shall include each of the documented cyber security plan(s) that collectively include each of the sections in Attachment 1 and additional evidence to demonstrate implementation of the cyber security plan(s). Additional examples of evidence per section are located in Attachment 2.
- R3.** Each Responsible Entity shall identify a CIP Senior Manager by name and document any change within 30 calendar days of the change. *[Violation Risk Factor: Medium]*  
*[Time Horizon: Operations Planning]*
- M3.** An example of evidence may include, but is not limited to, a dated and approved document from a high level official designating the name of the individual identified as the CIP Senior Manager.
- R4.** The Responsible Entity shall implement a documented process to delegate authority, unless no delegations are used. Where allowed by the CIP Standards, the CIP Senior Manager may delegate authority for specific actions to a delegate or delegates. These delegations shall be documented, including the name or title of the delegate, the specific actions delegated, and the date of the delegation; approved by the CIP Senior Manager; and updated within 30 days of any change to the delegation. Delegation changes do not need to be reinstated with a change to the delegator. *[Violation Risk Factor: Lower]* *[Time Horizon: Operations Planning]*
- M4.** An example of evidence may include, but is not limited to, a dated document, approved by the CIP Senior Manager, listing individuals (by name or title) who are delegated the authority to approve or authorize specifically identified items.

## C. Compliance

### 1. Compliance Monitoring Process

#### 1.1. Compliance Enforcement Authority:

As defined in the NERC Rules of Procedure, “Compliance Enforcement Authority” (CEA) means NERC or the Regional Entity in their respective roles of monitoring and enforcing compliance with the NERC Reliability Standards.

#### 1.2. Evidence Retention:

The following evidence retention periods identify the period of time an entity is required to retain specific evidence to demonstrate compliance. For instances where the evidence retention period specified below is shorter than the time since the last audit, the CEA may ask an entity to provide other evidence to show that it was compliant for the full time period since the last audit.

The Responsible Entity shall keep data or evidence to show compliance as identified below unless directed by its CEA to retain specific evidence for a longer period of time as part of an investigation:

- Each Responsible Entity shall retain evidence of each requirement in this standard for three calendar years.
- If a Responsible Entity is found non-compliant, it shall keep information related to the non-compliance until mitigation is complete and approved or for the time specified above, whichever is longer.
- The CEA shall keep the last audit records and all requested and submitted subsequent audit records.

#### 1.3. Compliance Monitoring and Assessment Processes:

- Compliance Audits
- Self-Certifications
- Spot Checking
- Compliance Investigations
- Self-Reporting
- Complaints

#### 1.4. Additional Compliance Information:

None.



~~2. Table of Compliance Elements~~

**Violation Severity Levels**

R #	Time Horizon	VRF	Violation Severity Levels (CIP-003-78)			
			Lower VSL	Moderate VSL	High VSL	Severe VSL
R1	Operations Planning	Medium	<p>The Responsible Entity documented and implemented one or more cyber security policies for its high impact and medium impact BES Cyber Systems, but did not address one of the nine topics required by R1. (R1.1)</p> <p>OR</p> <p>The Responsible Entity did not complete its review of the one or more documented cyber security policies for its high impact and medium impact BES Cyber Systems as required by R1 within 15 calendar</p>	<p>The Responsible Entity documented and implemented one or more cyber security policies for its high impact and medium impact BES Cyber Systems, but did not address two of the nine topics required by R1. (R1.1)</p> <p>OR</p> <p>The Responsible Entity did not complete its review of the one or more documented cyber security policies for its high impact and medium impact BES Cyber Systems as required by R1 within 16 calendar</p>	<p>The Responsible Entity documented and implemented one or more cyber security policies for its high impact and medium impact BES Cyber Systems, but did not address three of the nine topics required by R1. (R1.1)</p> <p>OR</p> <p>The Responsible Entity did not complete its review of the one or more documented cyber security policies for its high impact and medium impact BES Cyber Systems as required by R1 within 17 calendar months but did not complete this review in less than or equal to 18</p>	<p>The Responsible Entity documented and implemented one or more cyber security policies for its high impact and medium impact BES Cyber Systems, but did not address four or more of the nine topics required by R1. (R1.1)</p> <p>OR</p> <p>The Responsible Entity did not have any documented cyber security policies for its high impact and medium impact BES Cyber Systems as required by R1. (R1.1)</p> <p>OR</p>

R #	Time Horizon	VRF	Violation Severity Levels (CIP-003-78)			
			Lower VSL	Moderate VSL	High VSL	Severe VSL
			<p>months but did complete this review in less than or equal to 16 calendar months of the previous review. (R1.1)</p> <p>OR</p> <p>The Responsible Entity did not complete its approval of the one or more documented cyber security policies for its high impact and medium impact BES Cyber Systems as required by R1 by the CIP Senior Manager within 15 calendar months but did complete this approval in less than or equal to 16 calendar months of</p>	<p>months but did complete this review in less than or equal to 17 calendar months of the previous review. (R1.1)</p> <p>OR</p> <p>The Responsible Entity did not complete its approval of the one or more documented cyber security policies for its high impact and medium impact BES Cyber Systems as required by R1 by the CIP Senior Manager within 16 calendar months but did complete this approval in less than or equal to 17 calendar months of</p>	<p>calendar months of the previous review. (R1.1)</p> <p>OR</p> <p>The Responsible Entity did not complete its approval of the one or more documented cyber security policies for its high impact and medium impact BES Cyber Systems as required by R1 by the CIP Senior Manager within 17 calendar months but did complete this approval in less than or equal to 18 calendar months of the previous approval. (R1)</p> <p>OR</p> <p>The Responsible Entity documented one or more cyber security policies for its assets identified in CIP-002 containing low impact</p>	<p>The Responsible Entity did not complete its review of the one or more documented cyber security policies as required by R1 within 18 calendar months of the previous review. (R1)</p> <p>OR</p> <p>The Responsible Entity did not complete its approval of the one or more documented cyber security policies for its high impact and medium impact BES Cyber Systems as required by R1 by the CIP Senior Manager within 18 calendar months of the previous approval. (R1.1)</p>

R #	Time Horizon	VRF	Violation Severity Levels (CIP-003-78)			
			Lower VSL	Moderate VSL	High VSL	Severe VSL
			the previous approval. (R1.1) OR The Responsible Entity documented one or more cyber security policies for its assets identified in CIP-002 containing low impact BES Cyber Systems, but did not address one of the six topics required by R1. (R1.2) OR The Responsible Entity did not complete its review of the one or more documented cyber security policies for its assets identified in CIP-002 containing low impact BES Cyber Systems as	the previous approval. (R1.1) OR The Responsible Entity documented one or more cyber security policies for its assets identified in CIP-002 containing low impact BES Cyber Systems, but did not address two of the six topics required by R1. (R1.2) OR The Responsible Entity did not complete its review of the one or more documented cyber security policies for its assets identified in CIP-002 containing low impact BES Cyber Systems as	BES Cyber Systems, but did not address three of the six topics required by R1. (R1.2) OR The Responsible Entity did not complete its review of the one or more documented cyber security policies for its assets identified in CIP-002 containing low impact BES Cyber Systems as required by R1 within 17 calendar months but did not complete this review in less than or equal to 18 calendar months of the previous review. (R1.2) OR The Responsible Entity did not complete its approval of the one or more documented cyber security policies for its	OR The Responsible Entity documented one or more cyber security policies for its assets identified in CIP-002 containing low impact BES Cyber Systems, but did not address four or more of the six topics required by R1. (R1.2) OR The Responsible Entity did not have any documented cyber security policies for its assets identified in CIP-002 containing low impact BES Cyber Systems as required by R1. (R1.2) OR

R #	Time Horizon	VRF	Violation Severity Levels (CIP-003-78)			
			Lower VSL	Moderate VSL	High VSL	Severe VSL
			<p>required by Requirement R1 within 15 calendar months but did not complete this review in less than or equal to 16 calendar months of the previous review. (R1.2)</p> <p>OR</p> <p>The Responsible Entity did not complete its approval of the one or more documented cyber security policies for its assets identified in CIP-002 containing low impact BES Cyber Systems as required by Requirement R1 by the CIP Senior Manager within 15 calendar months but did complete this</p>	<p>required by Requirement R1 within 16 calendar months but did not complete this review in less than or equal to 17 calendar months of the previous review. (R1.2)</p> <p>OR</p> <p>The Responsible Entity did not complete its approval of the one or more documented cyber security policies for its assets identified in CIP-002 containing low impact BES Cyber Systems as required by Requirement R1 by the CIP Senior Manager within 16 calendar months but</p>	<p>assets identified in CIP-002 containing low impact BES Cyber Systems as required by Requirement R1 by the CIP Senior Manager within 17 calendar months but did not complete this approval in less than or equal to 18 calendar months of the previous approval. (R1.2)</p>	<p>The Responsible Entity did not complete its approval of the one or more documented cyber security policies for its assets identified in CIP-002 containing low impact BES Cyber Systems as required by Requirement R1 by the CIP Senior Manager within 18 calendar months of the previous approval. (R1.2)</p>

R #	Time Horizon	VRF	Violation Severity Levels (CIP-003-78)			
			Lower VSL	Moderate VSL	High VSL	Severe VSL
			approval in less than or equal to 16 calendar months of the previous approval. (R1.2)	did complete this approval in less than or equal to 17 calendar months of the previous approval. (R1.2)		
<b>R2</b>	<b>Operations Planning</b>	<b>Lower</b>	<p>The Responsible Entity documented its cyber security plan(s) for its assets containing low impact BES Cyber Systems, but failed to document cyber security awareness according to Requirement R2, Attachment 1, Section 1. (R2)</p> <p>OR</p> <p>The Responsible Entity implemented electronic access controls but failed to document its cyber security plan(s) for</p>	<p>The Responsible Entity documented its cyber security plan(s) for its assets containing low impact BES Cyber Systems, but failed to reinforce cyber security practices at least once every 15 calendar months according to Requirement R2, Attachment 1, Section 1. (R2)</p> <p>OR</p> <p>The Responsible Entity documented its cyber security plan(s) for its assets</p>	<p>The Responsible Entity documented the physical access controls for its assets containing low impact BES Cyber Systems, but failed to implement the physical security controls according to Requirement R2, Attachment 1, Section 2. (R2)</p> <p>OR</p> <p>The Responsible Entity documented its cyber security plan(s) for electronic access controls for its assets containing low impact BES Cyber Systems, but</p>	<p>The Responsible Entity failed to document and implement one or more cyber security plan(s) for its assets containing low impact BES Cyber Systems according to Requirement R2, Attachment 1. (R2)</p>

R #	Time Horizon	VRF	Violation Severity Levels (CIP-003-78)			
			Lower VSL	Moderate VSL	High VSL	Severe VSL
			electronic access controls according to Requirement R2, Attachment 1, Section 3. (R2) OR The Responsible Entity documented its cyber security plan(s) for its assets containing low impact BES Cyber Systems, but failed to document one or more Cyber Security Incident response plan(s) according to Requirement R2, Attachment 1, Section 4. (R2) OR The Responsible Entity documented one or more Cyber Security Incident response plan(s)	containing low impact BES Cyber Systems, but failed to document physical security controls according to Requirement R2, Attachment 1, Section 2. (R2) OR The Responsible Entity documented its cyber security plan(s) for its assets containing low impact BES Cyber Systems, but failed to document electronic access controls according to Requirement R2, Attachment 1, Section 3. (R2) OR The Responsible Entity documented	failed to permit only necessary inbound and outbound electronic access controls according to Requirement R2, Attachment 1, Section 3.1. (R2) OR The Responsible Entity documented one or more Cyber Security Incident response plan(s) within its cyber security plan(s) for its assets containing low impact BES Cyber Systems, but failed to test each Cyber Security Incident response plan(s) at least once every 36 calendar months according to Requirement R2, Attachment 1, Section 4. (R2) OR	

R #	Time Horizon	VRF	Violation Severity Levels (CIP-003-78)			
			Lower VSL	Moderate VSL	High VSL	Severe VSL
			<p>within its cyber security plan(s) for its assets containing low impact BES Cyber Systems, but failed to update each Cyber Security Incident response plan(s) within 180 days according to Requirement R2, Attachment 1, Section 4. (R2)</p> <p>OR</p> <p>The Responsible Entity documented its plan(s) for Transient Cyber Assets and Removable Media, but failed to manage its Transient Cyber Asset(s) according to Requirement R2, Attachment 1, Section 5.1. (R2)</p>	<p>its cyber security plan(s) for electronic access controls but failed to implement authentication for all Dial-up Connectivity that provides access to low impact BES Cyber System(s), per Cyber Asset capability according to Requirement R2, Attachment 1, Section 3.2 (R2)</p> <p>OR</p> <p>The Responsible Entity documented one or more incident response plan(s) within its cyber security plan(s) for its assets containing low impact BES Cyber Systems, but failed to include the process for identification,</p>	<p>The Responsible Entity documented the determination of whether an identified Cyber Security Incident is a Reportable Cyber Security Incident, but failed to notify the Electricity Information Sharing and Analysis Center (E-ISAC) according to Requirement R2, Attachment 1, Section 4. (R2)</p> <p>OR</p> <p>The Responsible Entity documented its plan(s) for Transient Cyber Assets and Removable Media, but failed to implement mitigation for the introduction of malicious code for Transient Cyber Assets managed by the Responsible Entity</p>	

R #	Time Horizon	VRF	Violation Severity Levels (CIP-003-78)			
			Lower VSL	Moderate VSL	High VSL	Severe VSL
			<p>OR</p> <p>The Responsible Entity documented its plan(s) for Transient Cyber Assets, but failed to document the Removable Media section(s) according to Requirement R2, Attachment 1, Section 5.3. (R2)</p>	<p>classification, and response to Cyber Security Incidents according to Requirement R2, Attachment 1, Section 4. (R2)</p> <p>OR</p> <p>The Responsible Entity documented its cyber security plan(s) for its assets containing low impact BES Cyber Systems, but failed to document the determination of whether an identified Cyber Security Incident is a Reportable Cyber Security Incident and subsequent notification to the Electricity Information Sharing and Analysis Center</p>	<p>according to Requirement R2, Attachment 1, Section 5.1. (R2)</p> <p>OR</p> <p>The Responsible Entity documented its plan(s) for Transient Cyber Assets and Removable Media, but failed to implement mitigation for the introduction of malicious code for Transient Cyber Assets managed by a party other than the Responsible Entity according to Requirement R2, Attachment 1, Section 5.2. (R2)</p> <p>OR</p> <p>The Responsible Entity documented its plan(s) for Transient Cyber Assets and Removable</p>	



R #	Time Horizon	VRF	Violation Severity Levels (CIP-003-78)			
			Lower VSL	Moderate VSL	High VSL	Severe VSL
				<p>(E-ISAC) according to Requirement R2, Attachment 1, Section 4. (R2)</p> <p>OR</p> <p>The Responsible Entity documented its plan(s) for Transient Cyber Assets and Removable Media, but failed to document mitigation for the introduction of malicious code for Transient Cyber Assets managed by the Responsible Entity according to Requirement R2, Attachment 1, Sections 5.1 and 5.3. (R2)</p> <p>OR</p> <p>The Responsible Entity documented</p>	<p>Media, but failed to implement mitigation for the threat of detected malicious code on the Removable Media prior to connecting Removable Media to a low impact BES Cyber System according to Requirement R2, Attachment 1, Section 5.3. (R2)</p>	

R #	Time Horizon	VRF	Violation Severity Levels (CIP-003-78)			
			Lower VSL	Moderate VSL	High VSL	Severe VSL
				<p>its plan(s) for Transient Cyber Assets and Removable Media, but failed to document mitigation for the introduction of malicious code for Transient Cyber Assets managed by a party other than the Responsible Entity according to Requirement R2, Attachment 1, Section 5.2. (R2)</p> <p>OR</p> <p>The Responsible Entity documented its plan(s) for Transient Cyber Assets and Removable Media, but failed to implement the Removable Media section(s) according</p>		

R #	Time Horizon	VRF	Violation Severity Levels (CIP-003-78)			
			Lower VSL	Moderate VSL	High VSL	Severe VSL
				to Requirement R2, Attachment 1, Section 5.3. (R2)		
<b>R3</b>	<b>Operations Planning</b>	<b>Medium</b>	The Responsible Entity has identified by name a CIP Senior Manager, but did not document changes to the CIP Senior Manager within 30 calendar days but did document this change in less than 40 calendar days of the change. (R3)	The Responsible Entity has identified by name a CIP Senior Manager, but did not document changes to the CIP Senior Manager within 40 calendar days but did document this change in less than 50 calendar days of the change. (R3)	The Responsible Entity has identified by name a CIP Senior Manager, but did not document changes to the CIP Senior Manager within 50 calendar days but did document this change in less than 60 calendar days of the change. (R3)	The Responsible Entity has not identified, by name, a CIP Senior Manager.  OR The Responsible Entity has identified by name a CIP Senior Manager, but did not document changes to the CIP Senior Manager within 60 calendar days of the change. (R3)
<b>R4</b>	<b>Operations Planning</b>	<b>Lower</b>	The Responsible Entity has identified a delegate by name, title, date of delegation, and specific actions	The Responsible Entity has identified a delegate by name, title, date of delegation, and specific actions	The Responsible Entity has identified a delegate by name, title, date of delegation, and specific actions delegated, but did not document	The Responsible Entity has used delegated authority for actions where allowed by the CIP Standards, but does

R #	Time Horizon	VRF	Violation Severity Levels (CIP-003-78)			
			Lower VSL	Moderate VSL	High VSL	Severe VSL
			delegated, but did not document changes to the delegate within 30 calendar days but did document this change in less than 40 calendar days of the change. (R4)	delegated, but did not document changes to the delegate within 40 calendar days but did document this change in less than 50 calendar days of the change. (R4)	changes to the delegate within 50 calendar days but did document this change in less than 60 calendar days of the change. (R4)	not have a process to delegate actions from the CIP Senior Manager. (R4) OR The Responsible Entity has identified a delegate by name, title, date of delegation, and specific actions delegated, but did not document changes to the delegate within 60 calendar days of the change. (R4)

**D. Regional Variances**

None.

**E. Interpretations**

None.

**F. Associated Documents**

None.

## Version History

Version	Date	Action	Change Tracking
1	1/16/06	R3.2 — Change “Control Center” to “control center.”	3/24/06
2	9/30/09	Modifications to clarify the requirements and to bring the compliance elements into conformance with the latest guidelines for developing compliance elements of standards.  Removal of reasonable business judgment.  Replaced the RRO with the RE as a responsible entity.  Rewording of Effective Date.  Changed compliance monitor to Compliance Enforcement Authority.	
3	12/16/09	Updated Version Number from -2 to -3  In Requirement 1.6, deleted the sentence pertaining to removing component or system from service in order to perform testing, in response to FERC order issued September 30, 2009.	
3	12/16/09	Approved by the NERC Board of Trustees.	
3	3/31/10	Approved by FERC.	
4	1/24/11	Approved by the NERC Board of Trustees.	
5	11/26/12	Adopted by the NERC Board of Trustees.	Modified to coordinate with other CIP standards and to revise format to use RBS Template.

Version	Date	Action	Change Tracking
5	11/22/13	FERC Order issued approving CIP-003-5.	
6	11/13/14	Adopted by the NERC Board of Trustees.	Addressed two FERC directives from Order No. 791 related to identify, assess, and correct language and communication networks.
6	2/12/15	Adopted by the NERC Board of Trustees.	Replaces the version adopted by the Board on 11/13/2014. Revised version addresses remaining directives from Order No. 791 related to transient devices and low impact BES Cyber Systems.
6	1/21/16	FERC Order issued approving CIP-003-6. Docket No. RM15-14-000	
7	2/9/17	Adopted by the NERC Board of Trustees.	Revised to address FERC Order No. 822 directives regarding (1) the definition of LERC and (2) transient devices.
7	4/19/18	FERC Order issued approving CIP-003-7. Docket No. RM17-11-000	

Version	Date	Action	Change Tracking
<u>8</u>	<u>5/9/19</u>	<u>Adopted by the NERC Board of Trustees.</u>	<u>Removed SPS references.</u> <u>Revised to address FERC Order No. 843 regarding mitigating the risk of malicious code.</u>

## Attachment 1

### Required Sections for Cyber Security Plan(s) for Assets Containing Low Impact BES Cyber Systems

Responsible Entities shall include each of the sections provided below in the cyber security plan(s) required under Requirement R2.

Responsible Entities with multiple-impact BES Cyber Systems ratings can utilize policies, procedures, and processes for their high or medium impact BES Cyber Systems to fulfill the sections for the development of low impact cyber security plan(s). Each Responsible Entity can develop a cyber security plan(s) either by individual asset or groups of assets.

**Section 1.** Cyber Security Awareness: Each Responsible Entity shall reinforce, at least once every 15 calendar months, cyber security practices (which may include associated physical security practices).

**Section 2.** Physical Security Controls: Each Responsible Entity shall control physical access, based on need as determined by the Responsible Entity, to (1) the asset or the locations of the low impact BES Cyber Systems within the asset, and (2) the Cyber Asset(s), as specified by the Responsible Entity, that provide electronic access control(s) implemented for Section 3.1, if any.

**Section 3.** Electronic Access Controls: For each asset containing low impact BES Cyber System(s) identified pursuant to CIP-002, the Responsible Entity shall implement electronic access controls to:

- 3.1** Permit only necessary inbound and outbound electronic access as determined by the Responsible Entity for any communications that are:
  - i. between a low impact BES Cyber System(s) and a Cyber Asset(s) outside the asset containing low impact BES Cyber System(s);
  - ii. using a routable protocol when entering or leaving the asset containing the low impact BES Cyber System(s); and
  - iii. not used for time-sensitive protection or control functions between intelligent electronic devices (e.g., communications using protocol IEC TR-61850-90-5 R-GOOSE).
- 3.2** Authenticate all Dial-up Connectivity, if any, that provides access to low impact BES Cyber System(s), per Cyber Asset capability.

**Section 4.** Cyber Security Incident Response: Each Responsible Entity shall have one or more Cyber Security Incident response plan(s), either by asset or group of assets, which shall include:

- 4.1** Identification, classification, and response to Cyber Security Incidents;
- 4.2** Determination of whether an identified Cyber Security Incident is a Reportable Cyber Security Incident and subsequent notification to the



Electricity Information Sharing and Analysis Center (E-ISAC), unless prohibited by law;

- 4.3 Identification of the roles and responsibilities for Cyber Security Incident response by groups or individuals;
- 4.4 Incident handling for Cyber Security Incidents;
- 4.5 Testing the Cyber Security Incident response plan(s) at least once every 36 calendar months by: (1) responding to an actual Reportable Cyber Security Incident; (2) using a drill or tabletop exercise of a Reportable Cyber Security Incident; or (3) using an operational exercise of a Reportable Cyber Security Incident; and
- 4.6 Updating the Cyber Security Incident response plan(s), if needed, within 180 calendar days after completion of a Cyber Security Incident response plan(s) test or actual Reportable Cyber Security Incident.

**Section 5. Transient Cyber Asset and Removable Media Malicious Code Risk Mitigation:** Each Responsible Entity shall implement, except under CIP Exceptional Circumstances, one or more plan(s) to achieve the objective of mitigating the risk of the introduction of malicious code to low impact BES Cyber Systems through the use of Transient Cyber Assets or Removable Media. The plan(s) shall include:

- 5.1 For Transient Cyber Asset(s) managed by the Responsible Entity, if any, the use of one or a combination of the following in an ongoing or on-demand manner (per Transient Cyber Asset capability):
  - Antivirus software, including manual or managed updates of signatures or patterns;
  - Application whitelisting; or
  - Other method(s) to mitigate the introduction of malicious code.
- 5.2 For Transient Cyber Asset(s) managed by a party other than the Responsible Entity, if any, ~~the use of:~~

**5.2.1 Use** one or a combination of the following prior to connecting the Transient Cyber Asset to a low impact BES Cyber System (per Transient Cyber Asset capability):

- Review of antivirus update level;
- Review of antivirus update process used by the party;
- Review of application whitelisting used by the party;
- Review use of live operating system and software executable only from read-only media;
- Review of system hardening used by the party; or

- Other method(s) to mitigate the introduction of malicious code.

5.2.2 For any method used pursuant to 5.2.1, Responsible Entities shall determine whether any additional mitigation actions are necessary and implement such actions prior to connecting the Transient Cyber Asset.

**5.3** For Removable Media, the use of each of the following:

**5.3.1** Method(s) to detect malicious code on Removable Media using a Cyber Asset other than a BES Cyber System; and

**5.3.2** Mitigation of the threat of detected malicious code on the Removable Media prior to connecting Removable Media to a low impact BES Cyber System.

## Attachment 2

### Examples of Evidence for Cyber Security Plan(s) for Assets Containing Low Impact BES Cyber Systems

**Section 1. Cyber Security Awareness:** An example of evidence for Section 1 may include, but is not limited to, documentation that the reinforcement of cyber security practices occurred at least once every 15 calendar months. The evidence could be documentation through one or more of the following methods:

- Direct communications (for example, e-mails, memos, or computer-based training);
- Indirect communications (for example, posters, intranet, or brochures); or
- Management support and reinforcement (for example, presentations or meetings).

**Section 2. Physical Security Controls:** Examples of evidence for Section 2 may include, but are not limited to:

- Documentation of the selected access control(s) (e.g., card key, locks, perimeter controls), monitoring controls (e.g., alarm systems, human observation), or other operational, procedural, or technical physical security controls that control physical access to both:
  - a. The asset, if any, or the locations of the low impact BES Cyber Systems within the asset; and
  - b. The Cyber Asset(s) specified by the Responsible Entity that provide(s) electronic access controls implemented for Attachment 1, Section 3.1, if any.

**Section 3. Electronic Access Controls:** Examples of evidence for Section 3 may include, but are not limited to:

1. Documentation showing that at each asset or group of assets containing low impact BES Cyber Systems, routable communication between a low impact BES Cyber System(s) and a Cyber Asset(s) outside the asset is restricted by electronic access controls to permit only inbound and outbound electronic access that the Responsible Entity deems necessary, except where an entity provides rationale that communication is used for time-sensitive protection or control functions between intelligent electronic devices. Examples of such documentation may include, but are not limited to representative diagrams that illustrate control of inbound and outbound communication(s) between the low impact BES Cyber System(s) and a Cyber Asset(s) outside the asset containing low impact BES Cyber System(s) or lists of implemented electronic access controls (e.g., access control lists restricting IP addresses, ports, or services; implementing unidirectional gateways).

2. Documentation of authentication for Dial-up Connectivity (e.g., dial out only to a preprogrammed number to deliver data, dial-back modems, modems that must be remotely controlled by the control center or control room, or access control on the BES Cyber System).

**Section 4. Cyber Security Incident Response:** An example of evidence for Section 4 may include, but is not limited to, dated documentation, such as policies, procedures, or process documents of one or more Cyber Security Incident response plan(s) developed either by asset or group of assets that include the following processes:

1. to identify, classify, and respond to Cyber Security Incidents; to determine whether an identified Cyber Security Incident is a Reportable Cyber Security Incident and for notifying the Electricity Information Sharing and Analysis Center (E-ISAC);
2. to identify and document the roles and responsibilities for Cyber Security Incident response by groups or individuals (e.g., initiating, documenting, monitoring, reporting, etc.);
3. for incident handling of a Cyber Security Incident (e.g., containment, eradication, or recovery/incident resolution);
4. for testing the plan(s) along with the dated documentation that a test has been completed at least once every 36 calendar months; and
5. to update, as needed, Cyber Security Incident response plan(s) within 180 calendar days after completion of a test or actual Reportable Cyber Security Incident.

**Section 5. Transient Cyber Asset and Removable Media Malicious Code Risk Mitigation:**

1. Examples of evidence for Section 5.1 may include, but are not limited to, documentation of the method(s) used to mitigate the introduction of malicious code such as antivirus software and processes for managing signature or pattern updates, application whitelisting practices, processes to restrict communication, or other method(s) to mitigate the introduction of malicious code. If a Transient Cyber Asset does not have the capability to use method(s) that mitigate the introduction of malicious code, evidence may include documentation by the vendor or Responsible Entity that identifies that the Transient Cyber Asset does not have the capability.
2. Examples of evidence for Section 5.2.1 may include, but are not limited to, documentation from change management systems, electronic mail or procedures that document a review of the installed antivirus update level; memoranda, electronic mail, system documentation, policies or contracts from the party other than the Responsible Entity that identify the antivirus update process, the use of application whitelisting, use of live operating systems or system hardening performed by the party other than the Responsible Entity; evidence from change management systems, electronic mail or contracts that

identifies the Responsible Entity's acceptance that the practices of the party other than the Responsible Entity are acceptable; or documentation of other method(s) to mitigate malicious code for Transient Cyber Asset(s) managed by a party other than the Responsible Entity. If a Transient Cyber Asset does not have the capability to use method(s) that mitigate the introduction of malicious code, evidence may include documentation by the Responsible Entity or the party other than the Responsible Entity that identifies that the Transient Cyber Asset does not have the capability.

Examples of evidence for Attachment 1, Section 5.2.2 may include, but are not limited to, documentation from change management systems, electronic mail, or contracts that identifies a review to determine whether additional mitigation is necessary and has been implemented prior to connecting the Transient Cyber Asset managed by a party other than the Responsible Entity.

3. Examples of evidence for Section 5.3.1 may include, but are not limited to, documented process(es) of the method(s) used to detect malicious code such as results of scan settings for Removable Media, or implementation of on-demand scanning. Examples of evidence for Section 5.3.2 may include, but are not limited to, documented process(es) for the method(s) used for mitigating the threat of detected malicious code on Removable Media, such as logs from the method(s) used to detect malicious code that show the results of scanning and the mitigation of detected malicious code on Removable Media or documented confirmation by the entity that the Removable Media was deemed to be free of malicious code.

## Guidelines and Technical Basis

### Section 4 – Scope of Applicability of the CIP Cyber Security Standards

Section “4. Applicability” of the standards provides important information for Responsible Entities to determine the scope of the applicability of the CIP Cyber Security Requirements.

Section “4.1. Functional Entities” is a list of NERC functional entities to which the standard applies. If the entity is registered as one or more of the functional entities listed in Section 4.1, then the NERC CIP Cyber Security Standards apply. Note that there is a qualification in Section 4.1 that restricts the applicability in the case of Distribution Providers to only those that own certain types of systems and equipment listed in 4.2.

Section “4.2. Facilities” defines the scope of the Facilities, systems, and equipment owned by the Responsible Entity, as qualified in Section 4.1, that is subject to the requirements of the standard. In addition to the set of BES Facilities, Control Centers, and other systems and equipment, the list includes the set of systems and equipment owned by Distribution Providers. While the NERC Glossary term “Facilities” already includes the BES characteristic, the additional use of the term BES here is meant to reinforce the scope of applicability of these Facilities where it is used, especially in this applicability scoping section. This in effect sets the scope of Facilities, systems, and equipment that is subject to the standards.

#### Requirement R1:

In developing policies in compliance with Requirement R1, the number of policies and their content should be guided by a Responsible Entity's management structure and operating conditions. Policies might be included as part of a general information security program for the entire organization, or as components of specific programs. The Responsible Entity has the flexibility to develop a single comprehensive cyber security policy covering the required topics, or it may choose to develop a single high-level umbrella policy and provide additional policy detail in lower level documents in its documentation hierarchy. In the case of a high-level umbrella policy, the Responsible Entity would be expected to provide the high-level policy as well as the additional documentation in order to demonstrate compliance with CIP-003-78, Requirement R1.

If a Responsible Entity has any high or medium impact BES Cyber Systems, the one or more cyber security policies must cover the nine subject matter areas required by CIP-003-78, Requirement R1, Part 1.1. If a Responsible Entity has identified from CIP-002 any assets containing low impact BES Cyber Systems, the one or more cyber security policies must cover the six subject matter areas required by Requirement R1, Part 1.2.

Responsible Entities that have multiple-impact rated BES Cyber Systems are not required to create separate cyber security policies for high, medium, or low impact BES Cyber Systems. The Responsible Entities have the flexibility to develop policies that cover all three impact ratings.

Implementation of the cyber security policy is not specifically included in CIP-003-78, Requirement R1 as it is envisioned that the implementation of this policy is evidenced through successful implementation of CIP-003 through CIP-011. However, Responsible Entities are encouraged not to limit the scope of their cyber security policies to only those requirements in NERC cyber security Reliability Standards, but to develop a holistic cyber security policy

appropriate for its organization. Elements of a policy that extend beyond the scope of NERC's cyber security Reliability Standards will not be considered candidates for potential violations although they will help demonstrate the organization's internal culture of compliance and posture towards cyber security.

For Part 1.1, the Responsible Entity may consider the following for each of the required topics in its one or more cyber security policies for medium and high impact BES Cyber Systems, if any:

1.1.1 Personnel and training (CIP-004)

- Organization position on acceptable background investigations
- Identification of possible disciplinary action for violating this policy
- Account management

1.1.2 Electronic Security Perimeters (CIP-005) including Interactive Remote Access

- Organization stance on use of wireless networks
- Identification of acceptable authentication methods
- Identification of trusted and untrusted resources
- Monitoring and logging of ingress and egress at Electronic Access Points
- Maintaining up-to-date anti-malware software before initiating Interactive Remote Access
- Maintaining up-to-date patch levels for operating systems and applications used to initiate Interactive Remote Access
- Disabling VPN "split-tunneling" or "dual-homed" workstations before initiating Interactive Remote Access
- For vendors, contractors, or consultants: include language in contracts that requires adherence to the Responsible Entity's Interactive Remote Access controls

1.1.3 Physical security of BES Cyber Systems (CIP-006)

- Strategy for protecting Cyber Assets from unauthorized physical access
- Acceptable physical access control methods
- Monitoring and logging of physical ingress

1.1.4 System security management (CIP-007)

- Strategies for system hardening
- Acceptable methods of authentication and access control
- Password policies including length, complexity, enforcement, prevention of brute force attempts
- Monitoring and logging of BES Cyber Systems

- 1.1.5 Incident reporting and response planning (CIP-008)
  - Recognition of Cyber Security Incidents
  - Appropriate notifications upon discovery of an incident
  - Obligations to report Cyber Security Incidents
- 1.1.6 Recovery plans for BES Cyber Systems (CIP-009)
  - Availability of spare components
  - Availability of system backups
- 1.1.7 Configuration change management and vulnerability assessments (CIP-010)
  - Initiation of change requests
  - Approval of changes
  - Break-fix processes
- 1.1.8 Information protection (CIP-011)
  - Information access control methods
  - Notification of unauthorized information disclosure
  - Information access on a need-to-know basis
- 1.1.9 Declaring and responding to CIP Exceptional Circumstances
  - Processes to invoke special procedures in the event of a CIP Exceptional Circumstance
  - Processes to allow for exceptions to policy that do not violate CIP requirements

For Part 1.2, the Responsible Entity may consider the following for each of the required topics in its one or more cyber security policies for assets containing low impact BES Cyber Systems, if any:

- 1.2.1 Cyber security awareness
  - Method(s) for delivery of security awareness
  - Identification of groups to receive cyber security awareness
- 1.2.2 Physical security controls
  - Acceptable approach(es) for selection of physical security control(s)
- 1.2.3 Electronic access controls
  - Acceptable approach(es) for selection of electronic access control(s)
- 1.2.4 Cyber Security Incident response
  - Recognition of Cyber Security Incidents



- Appropriate notifications upon discovery of an incident
- Obligations to report Cyber Security Incidents

#### 1.2.5 Transient Cyber Assets and Removable Media Malicious Code Risk Mitigation

- Acceptable use of Transient Cyber Asset(s) and Removable Media
- Method(s) to mitigate the risk of the introduction of malicious code to low impact BES Cyber Systems from Transient Cyber Assets and Removable Media
- Method(s) to request Transient Cyber Asset and Removable Media

#### 1.2.6 Declaring and responding to CIP Exceptional Circumstances

- Process(es) to declare a CIP Exceptional Circumstance
- Process(es) to respond to a declared CIP Exceptional Circumstance

Requirements relating to exceptions to a Responsible Entity's security policies were removed because it is a general management issue that is not within the scope of a reliability requirement. It is an internal policy requirement and not a reliability requirement. However, Responsible Entities are encouraged to continue this practice as a component of their cyber security policies.

In this and all subsequent required approvals in the NERC CIP Reliability Standards, the Responsible Entity may elect to use hardcopy or electronic approvals to the extent that there is sufficient evidence to ensure the authenticity of the approving party.

#### **Requirement R2:**

The intent of Requirement R2 is for each Responsible Entity to create, document, and implement one or more cyber security plan(s) that address the security objective for the protection of low impact BES Cyber Systems. The required protections are designed to be part of a program that covers the low impact BES Cyber Systems collectively at an asset level (based on the list of assets containing low impact BES Cyber Systems identified in CIP-002), but not at an individual device or system level.

### **Requirement R2, Attachment 1**

As noted, Attachment 1 contains the sections that must be included in the cyber security plan(s). The intent is to allow entities that have a combination of high, medium, and low impact BES Cyber Systems the flexibility to choose, if desired, to cover their low impact BES Cyber Systems (or any subset) under their programs used for the high or medium impact BES Cyber Systems rather than maintain two separate programs. The purpose of the cyber security plan(s) in Requirement R2 is for Responsible Entities to use the cyber security plan(s) as a means of documenting their approaches to meeting the subject matter areas. The cyber security plan(s) can be used to reference other policies and procedures that demonstrate “how” the Responsible Entity is meeting each of the subject matter areas, or Responsible Entities can develop comprehensive cyber security plan(s) that contain all of the detailed implementation content solely within the cyber security plan itself. To meet the obligation for the cyber security plan, the expectation is that the cyber security plan contains or references sufficient details to address the implementation of each of the required subject matters areas.

Guidance for each of the subject matter areas of Attachment 1 is provided below.

#### **Requirement R2, Attachment 1, Section 1 – Cyber Security Awareness**

The intent of the cyber security awareness program is for entities to reinforce good cyber security practices with their personnel at least once every 15 calendar months. The entity has the discretion to determine the topics to be addressed and the manner in which it will communicate these topics. As evidence of compliance, the Responsible Entity should be able to produce the awareness material that was delivered according to the delivery method(s) (e.g., posters, emails, or topics at staff meetings, etc.). The standard drafting team does not intend for Responsible Entities to be required to maintain lists of recipients and track the reception of the awareness material by personnel.

Although the focus of the awareness is cyber security, it does not mean that only technology-related topics can be included in the program. Appropriate physical security topics (e.g., tailgating awareness and protection of badges for physical security, or “If you see something, say something” campaigns, etc.) are valid for cyber security awareness. The intent is to cover topics concerning any aspect of the protection of BES Cyber Systems.

#### **Requirement R2, Attachment 1, Section 2 – Physical Security Controls**

The Responsible Entity must document and implement methods to control physical access to (1) the asset or the locations of low impact BES Cyber Systems within the asset, and (2) Cyber Assets that implement the electronic access control(s) specified by the Responsible Entity in Attachment 1, Section 3.1, if any. If these Cyber Assets implementing the electronic access controls are located within the same asset as the low impact BES Cyber Asset(s) and inherit the same physical access controls and the same need as outlined in Section 2, this may be noted by the Responsible Entity in either its policies or cyber security plan(s) to avoid duplicate documentation of the same controls.

The Responsible Entity has the flexibility to select the methods used to meet the objective of controlling physical access to (1) the asset(s) containing low impact BES Cyber System(s) or the low impact BES Cyber Systems themselves and (2) the electronic access control Cyber Assets specified by the Responsible Entity, if any. The Responsible Entity may use one or a

combination of physical access controls, monitoring controls, or other operational, procedural, or technical physical security controls. Entities may use perimeter controls (e.g., fences with locked gates, guards, or site access policies, etc.) or more granular areas of physical access control in areas where low impact BES Cyber Systems are located, such as control rooms or control houses.

The security objective is to control the physical access based on need as determined by the Responsible Entity. The need for physical access can be documented at the policy level. The standard drafting team did not intend to obligate an entity to specify a need for each physical access or authorization of an individual for physical access.

Monitoring as a physical security control can be used as a complement or an alternative to physical access control. Examples of monitoring controls include, but are not limited to: (1) alarm systems to detect motion or entry into a controlled area, or (2) human observation of a controlled area. Monitoring does not necessarily require logging and maintaining logs but could include monitoring that physical access has occurred or been attempted (e.g., door alarm, or human observation, etc.). The standard drafting team's intent is that the monitoring does not need to be per low impact BES Cyber System but should be at the appropriate level to meet the security objective of controlling physical access.

User authorization programs and lists of authorized users for physical access are not required although they are an option to meet the security objective.

**Requirement R2, Attachment 1, Section 3 – Electronic Access Controls**

Section 3 requires the establishment of electronic access controls for assets containing low impact BES Cyber Systems when there is routable protocol communication or Dial-up Connectivity between Cyber Asset(s) outside of the asset containing the low impact BES Cyber System(s) and the low impact BES Cyber System(s) within such asset. The establishment of electronic access controls is intended to reduce the risks associated with uncontrolled communication using routable protocols or Dial-up Connectivity.

When implementing Attachment 1, Section 3.1, Responsible Entities should note that electronic access controls to permit only necessary inbound and outbound electronic access are required for communications when those communications meet all three of the criteria identified in Attachment 1, Section 3.1. The Responsible Entity should evaluate the communications and when all three criteria are met, the Responsible Entity must document and implement electronic access control(s).

When identifying electronic access controls, Responsible Entities are provided flexibility in the selection of the electronic access controls that meet their operational needs while meeting the security objective of allowing only necessary inbound and outbound electronic access to low impact BES Cyber Systems that use routable protocols between a low impact BES Cyber System(s) and Cyber Asset(s) outside the asset.

In essence, the intent is for Responsible Entities to determine whether there is communication between a low impact BES Cyber System(s) and a Cyber Asset(s) outside the asset containing low impact BES Cyber System(s) that uses a routable protocol when entering or leaving the asset or Dial-up Connectivity to the low impact BES Cyber System(s). Where such

communication is present, Responsible Entities should document and implement electronic access control(s). Where routable protocol communication for time-sensitive protection or control functions between intelligent electronic devices that meets the exclusion language is present, Responsible Entities should document that communication, but are not required to establish any specific electronic access controls.

The inputs to this requirement are the assets identified in CIP-002 as containing low impact BES Cyber System(s); therefore, the determination of routable protocol communications or Dial-up Connectivity is an attribute of the asset. However, it is not intended for communication that provides no access to or from the low impact BES Cyber System(s), but happens to be located at the asset with the low impact BES Cyber System(s), to be evaluated for electronic access controls.

#### Electronic Access Control Exclusion

In order to avoid future technology issues, the obligations for electronic access controls exclude communications between intelligent electronic devices that use routable communication protocols for time-sensitive protection or control functions, such as IEC TR-61850-90-5 R-GOOSE messaging. Time-sensitive in this context generally means functions that would be negatively impacted by the latency introduced in the communications by the required electronic access controls. This time-sensitivity exclusion does not apply to SCADA communications which typically operate on scan rates of 2 seconds or greater. While technically time-sensitive, SCADA communications over routable protocols can withstand the delay introduced by electronic access controls. Examples of excluded time-sensitive communications are those communications which may necessitate the tripping of a breaker within a few cycles. A Responsible Entity using this technology is not expected to implement the electronic access controls noted herein. This exception was included so as not to inhibit the functionality of the time-sensitive characteristics related to this technology and not to preclude the use of such time-sensitive reliability enhancing functions if they use a routable protocol in the future.

#### **Considerations for Determining Routable Protocol Communications**

To determine whether electronic access controls need to be implemented, the Responsible Entity has to determine whether there is communication between a low impact BES Cyber System(s) and a Cyber Asset(s) outside the asset containing the low impact BES Cyber System(s) that uses a routable protocol when entering or leaving the asset.

When determining whether a routable protocol is entering or leaving the asset containing the low impact BES Cyber System(s), Responsible Entities have flexibility in identifying an approach. One approach is for Responsible Entities to identify an “electronic boundary” associated with the asset containing low impact BES Cyber System(s). This is not an Electronic Security Perimeter *per se*, but a demarcation that demonstrates the routable protocol communication entering or leaving the asset between a low impact BES Cyber System and Cyber Asset(s) outside the asset to then have electronic access controls implemented. This electronic boundary may vary by asset type (Control Center, substation, generation resource) and the specific configuration of the asset. If this approach is used, the intent is for the Responsible Entity to define the electronic boundary such that the low impact BES Cyber System(s) located

at the asset are contained within the “electronic boundary.” This is strictly for determining which routable protocol communications and networks are internal or inside or local to the asset and which are external to or outside the asset.

Alternatively, the Responsible Entity may find the concepts of what is inside and outside to be intuitively obvious for a Cyber Asset(s) outside the asset containing low impact BES Cyber System(s) communicating to a low impact BES Cyber System(s) inside the asset. This may be the case when a low impact BES Cyber System(s) is communicating with a Cyber Asset many miles away and a clear and unambiguous demarcation exists. In this case, a Responsible Entity may decide not to identify an “electronic boundary,” but rather to simply leverage the unambiguous asset demarcation to ensure that the electronic access controls are placed between the low impact BES Cyber System(s) and the Cyber Asset(s) outside the asset.

### **Determining Electronic Access Controls**

Once a Responsible Entity has determined that there is routable communication between a low impact BES Cyber System(s) and a Cyber Asset(s) outside the asset containing the low impact BES Cyber System(s) that uses a routable protocol when entering or leaving the asset containing the low impact BES Cyber System(s), the intent is for the Responsible Entity to document and implement its chosen electronic access control(s). The control(s) are intended to allow only “necessary” inbound and outbound electronic access as determined by the Responsible Entity. However the Responsible Entity chooses to document the inbound and outbound access permissions and the need, the intent is that the Responsible Entity is able to explain the reasons for the electronic access permitted. The reasoning for “necessary” inbound and outbound electronic access controls may be documented within the Responsible Entity’s cyber security plan(s), within a comment on an access control list, a database, spreadsheet or other policies or procedures associated with the electronic access controls.

### **Concept Diagrams**

The diagrams on the following pages are provided as examples to illustrate various electronic access controls at a conceptual level. Regardless of the concepts or configurations chosen by the Responsible Entity, the intent is to achieve the security objective of permitting only necessary inbound and outbound electronic access for communication between low impact BES Cyber Systems and Cyber Asset(s) outside the asset containing the low impact BES Cyber System(s) using a routable protocol when entering or leaving the asset.

#### **NOTE:**

- This is not an exhaustive list of applicable concepts.
- The same legend is used in each diagram; however, the diagram may not contain all of the articles represented in the legend.

### Reference Model 1 – Host-based Inbound & Outbound Access Permissions

The Responsible Entity may choose to utilize a host-based firewall technology on the low impact BES Cyber System(s) itself that manages the inbound and outbound electronic access permissions so that only necessary inbound and outbound electronic access is allowed between the low impact BES Cyber System(s) and the Cyber Asset(s) outside the asset containing the low impact BES Cyber System(s). When permitting the inbound and outbound electronic access permissions using access control lists, the Responsible Entity could restrict communication(s) using source and destination addresses or ranges of addresses. Responsible Entities could also restrict communication(s) using ports or services based on the capability of the electronic access control, the low impact BES Cyber System(s), or the application(s).

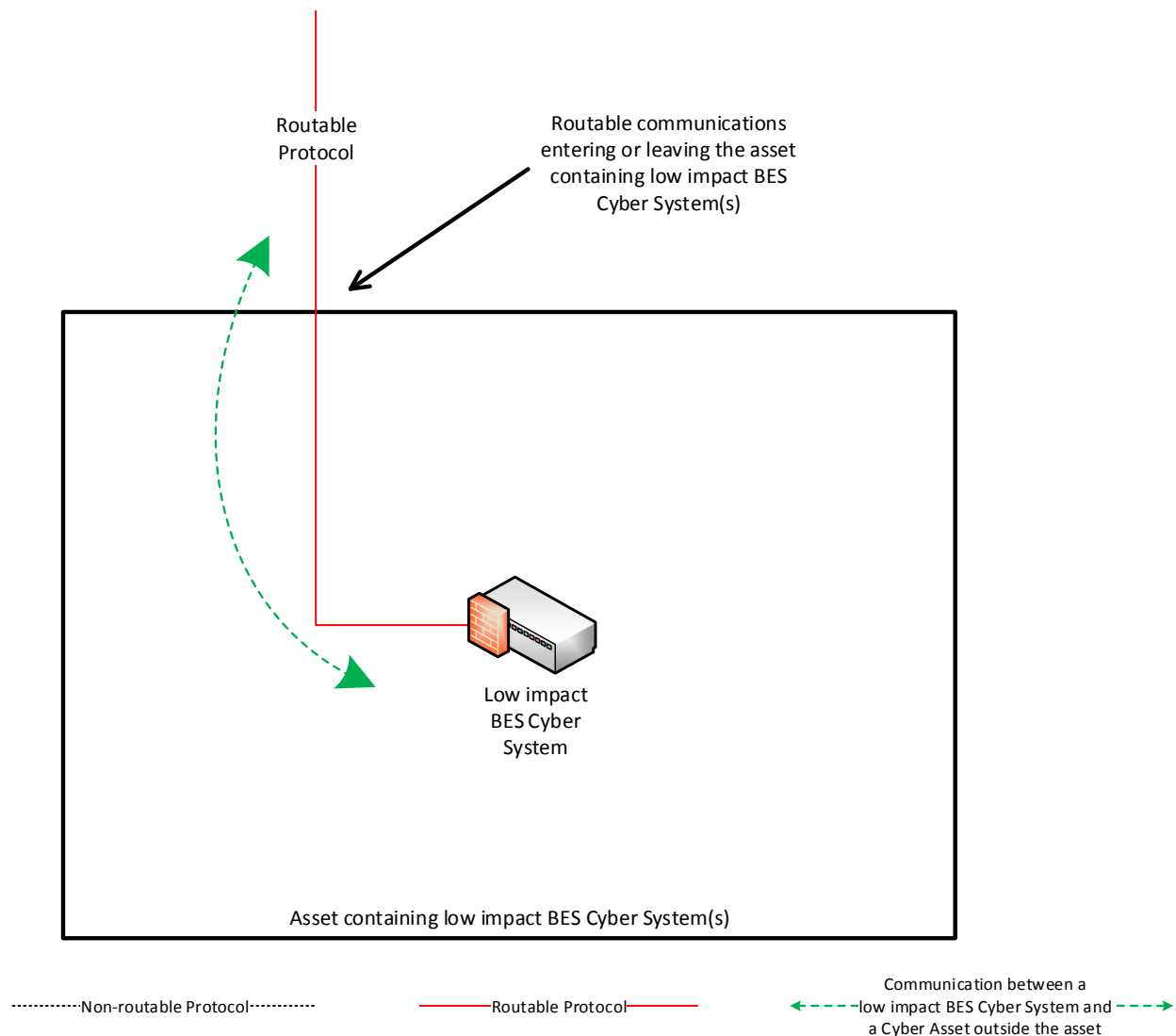

*Reference Model 1*

### Reference Model 2 – Network-based Inbound & Outbound Access Permissions

The Responsible Entity may choose to use a security device that permits only necessary inbound and outbound electronic access to the low impact BES Cyber System(s) within the asset containing the low impact BES Cyber System(s). In this example, two low impact BES Cyber Systems are accessed using the routable protocol that is entering or leaving the asset containing the low impact BES Cyber System(s). The IP/Serial converter is continuing the same communications session from the Cyber Asset(s) that are outside the asset to the low impact BES Cyber System(s). The security device provides the electronic access controls to permit only necessary inbound and outbound routable protocol access to the low impact BES Cyber System(s). When permitting the inbound and outbound electronic access permissions using access control lists, the Responsible Entity could restrict communication(s) using source and destination addresses or ranges of addresses. Responsible Entities could also restrict communication(s) using ports or services based on the capability of the electronic access control, the low impact BES Cyber System(s), or the application(s).

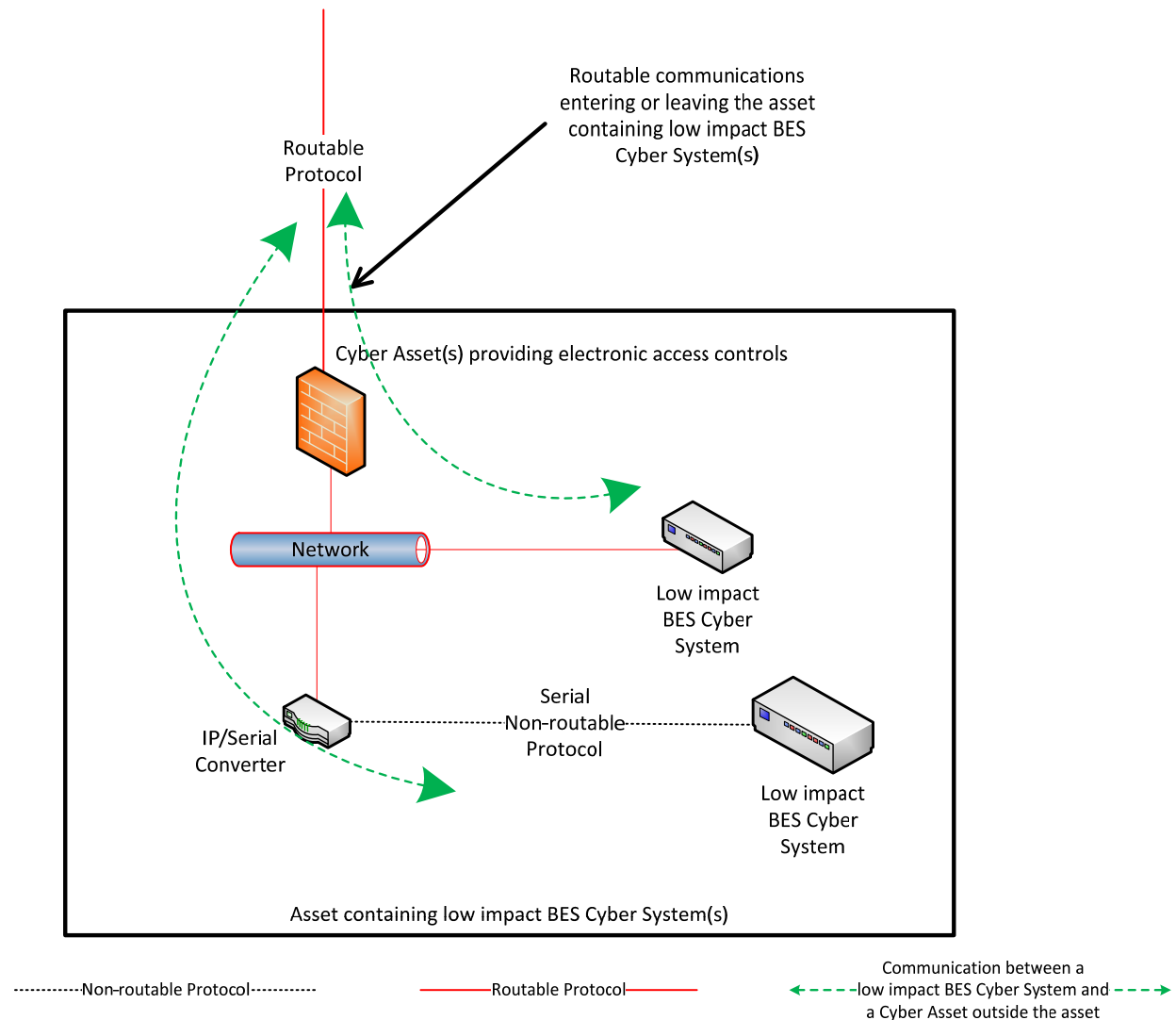

Reference Model 2

### Reference Model 3 – Centralized Network-based Inbound & Outbound Access Permissions

The Responsible Entity may choose to utilize a security device at a centralized location that may or may not be at another asset containing low impact BES Cyber System(s). The electronic access control(s) do not necessarily have to reside inside the asset containing the low impact BES Cyber System(s). A security device is in place at “Location X” to act as the electronic access control and permit only necessary inbound and outbound routable protocol access between the low impact BES Cyber System(s) and the Cyber Asset(s) outside each asset containing low impact BES Cyber System(s). Care should be taken that electronic access to or between each asset is through the Cyber Asset(s) determined by the Responsible Entity to be performing electronic access controls at the centralized location. When permitting the inbound and outbound electronic access permissions using access control lists, the Responsible Entity could restrict communication(s) using source and destination addresses or ranges of addresses. Responsible Entities could also restrict communication(s) using ports or services based on the capability of the electronic access control, the low impact BES Cyber System(s), or the application(s).

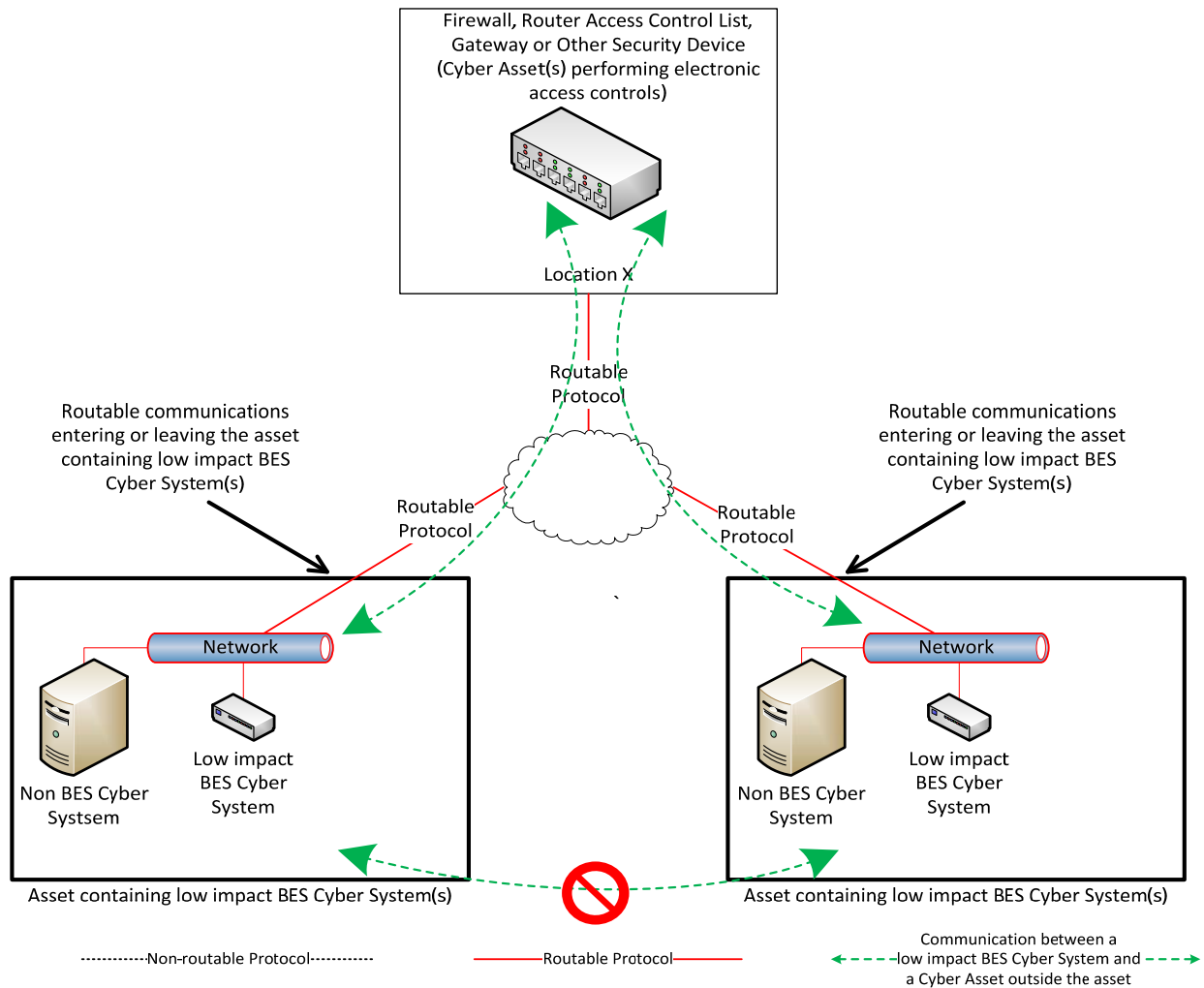

Reference Model 3



### Reference Model 4 – Uni-directional Gateway

The Responsible Entity may choose to utilize a uni-directional gateway as the electronic access control. The low impact BES Cyber System(s) is not accessible (data cannot flow into the low impact BES Cyber System) using the routable protocol entering the asset due to the implementation of a “one-way” (uni-directional) path for data to flow. The uni-directional gateway is configured to permit only the necessary outbound communications using the routable protocol communication leaving the asset.

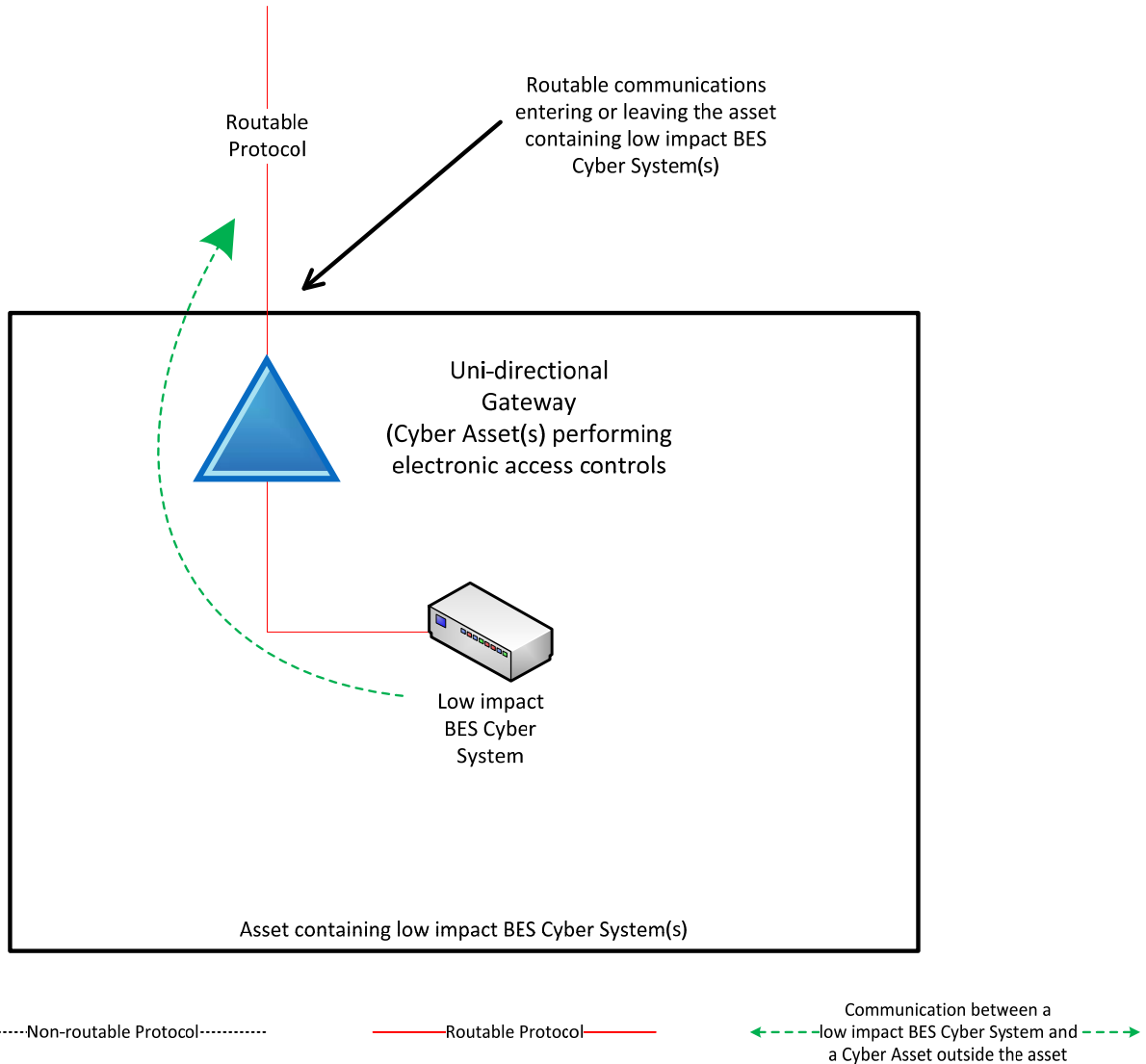

Reference Model 4

### Reference Model 5 – User Authentication

This reference model demonstrates that Responsible Entities have flexibility in choosing electronic access controls so long as the security objective of the requirement is met. The Responsible Entity may choose to utilize a non-BES Cyber Asset located at the asset containing the low impact BES Cyber System that requires authentication for communication from the Cyber Asset(s) outside the asset. This non-BES Cyber System performing the authentication permits only authenticated communication to connect to the low impact BES Cyber System(s), meeting the first half of the security objective to permit only necessary inbound electronic access. Additionally, the non-BES Cyber System performing authentication is configured such that it permits only necessary outbound communication meeting the second half of the security objective. Often, the outbound communications would be controlled in this network architecture by permitting no communication to be initiated from the low impact BES Cyber System. This configuration may be beneficial when the only communication to a device is for user-initiated interactive access.

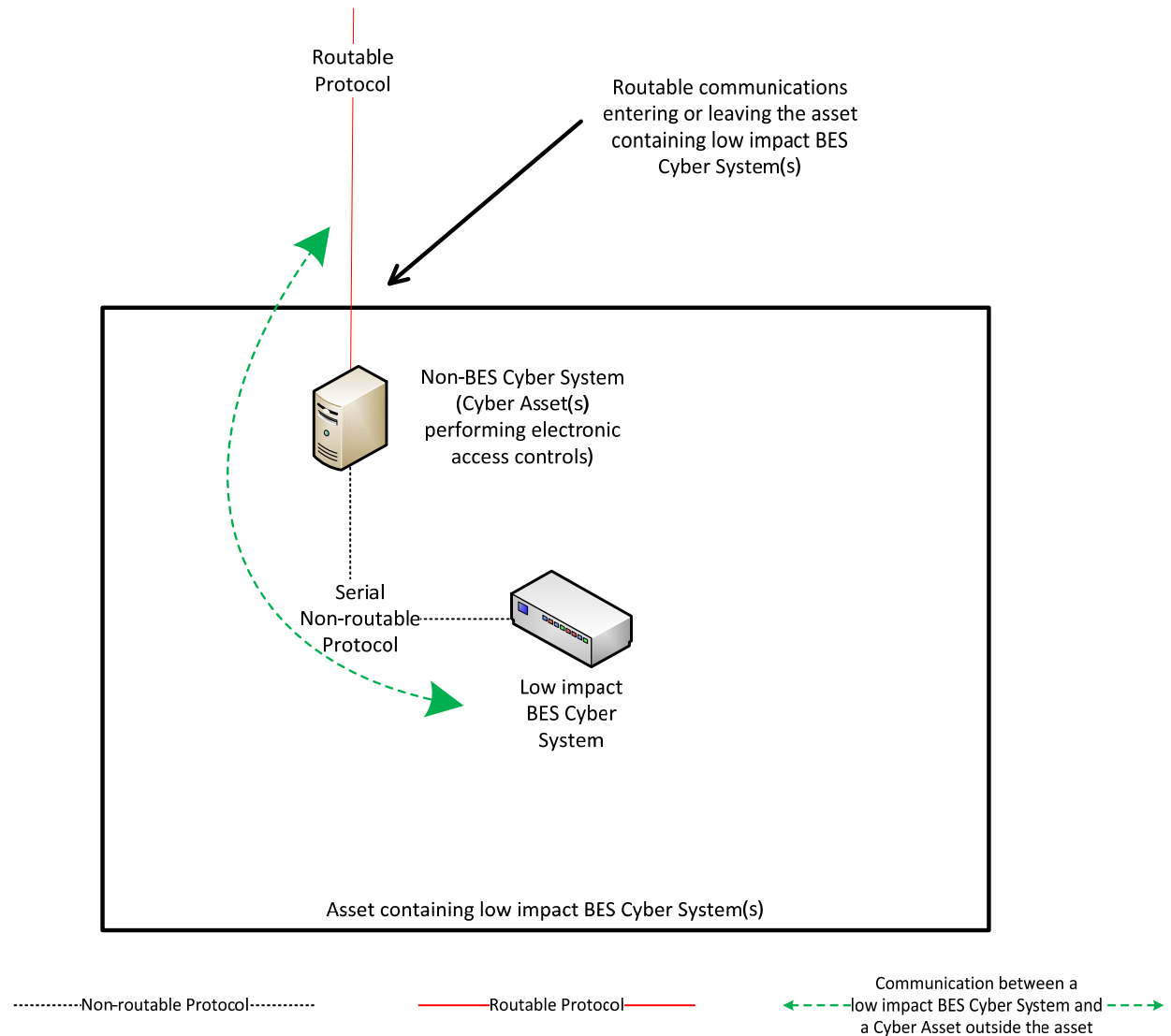

Reference Model 5

### Reference Model 6 – Indirect Access

In implementing its electronic access controls, the Responsible Entity may identify that it has indirect access between the low impact BES Cyber System and a Cyber Asset outside the asset containing the low impact BES Cyber System through a non-BES Cyber Asset located within the asset. This indirect access meets the criteria of having communication between the low impact BES Cyber System and a Cyber Asset outside the asset containing the low impact BES Cyber System. In this reference model, it is intended that the Responsible Entity implement electronic access controls that permit only necessary inbound and outbound electronic access to the low impact BES Cyber System. Consistent with the other reference models provided, the electronic access in this reference model is controlled using the security device that is restricting the communication that is entering or leaving the asset.

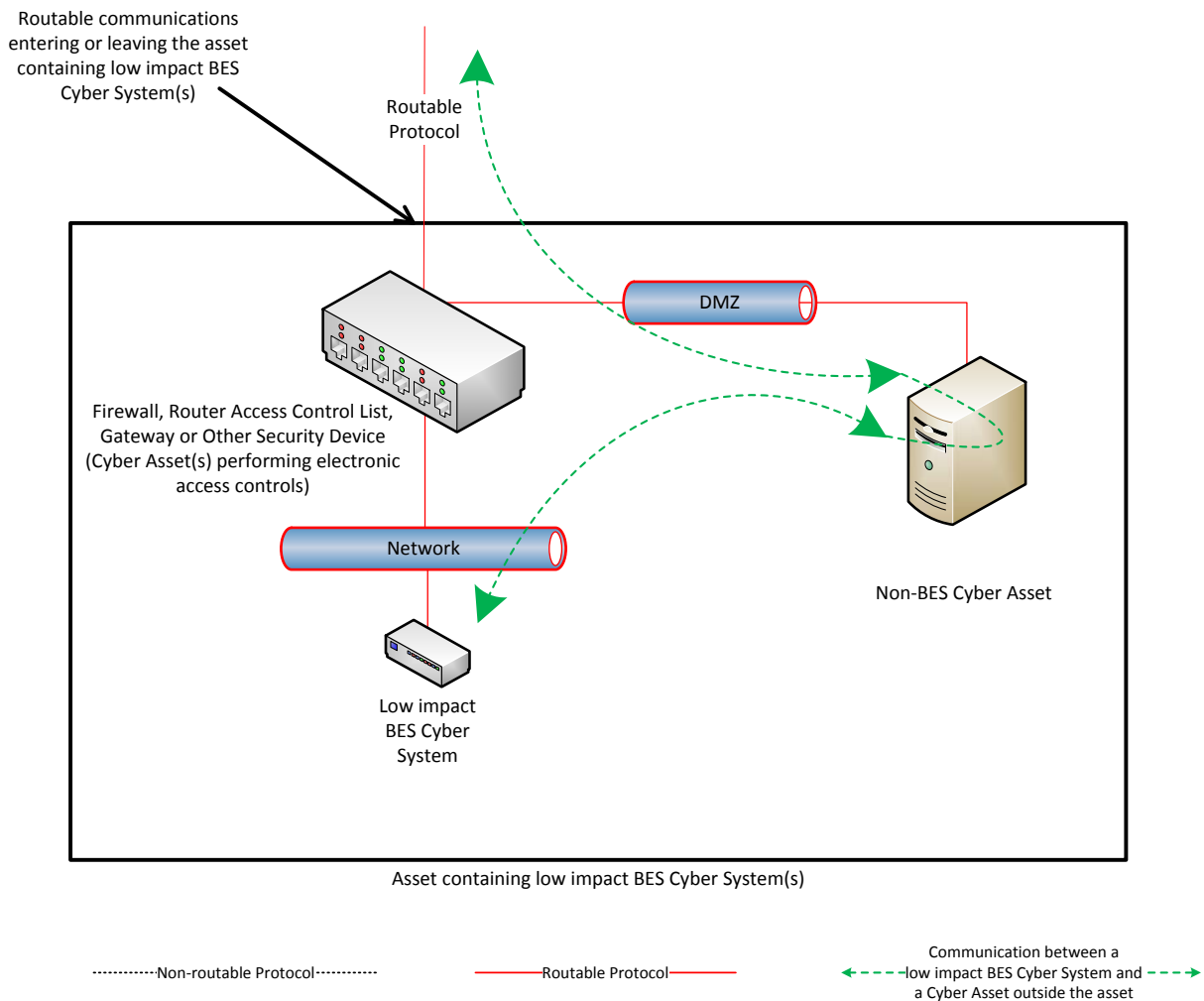

Reference Model 6

### Reference Model 7 – Electronic Access Controls at assets containing low impact BES Cyber Systems and ERC

In this reference model, there is both a routable protocol entering and leaving the asset containing the low impact BES Cyber System(s) that is used by Cyber Asset(s) outside the asset and External Routable Connectivity because there is at least one medium impact BES Cyber System and one low impact BES Cyber System within the asset using the routable protocol communications. The Responsible Entity may choose to leverage an interface on the medium impact Electronic Access Control or Monitoring Systems (EACMS) to provide electronic access controls for purposes of CIP-003. The EACMS is therefore performing multiple functions – as a medium impact EACMS and as implementing electronic access controls for an asset containing low impact BES Cyber Systems.

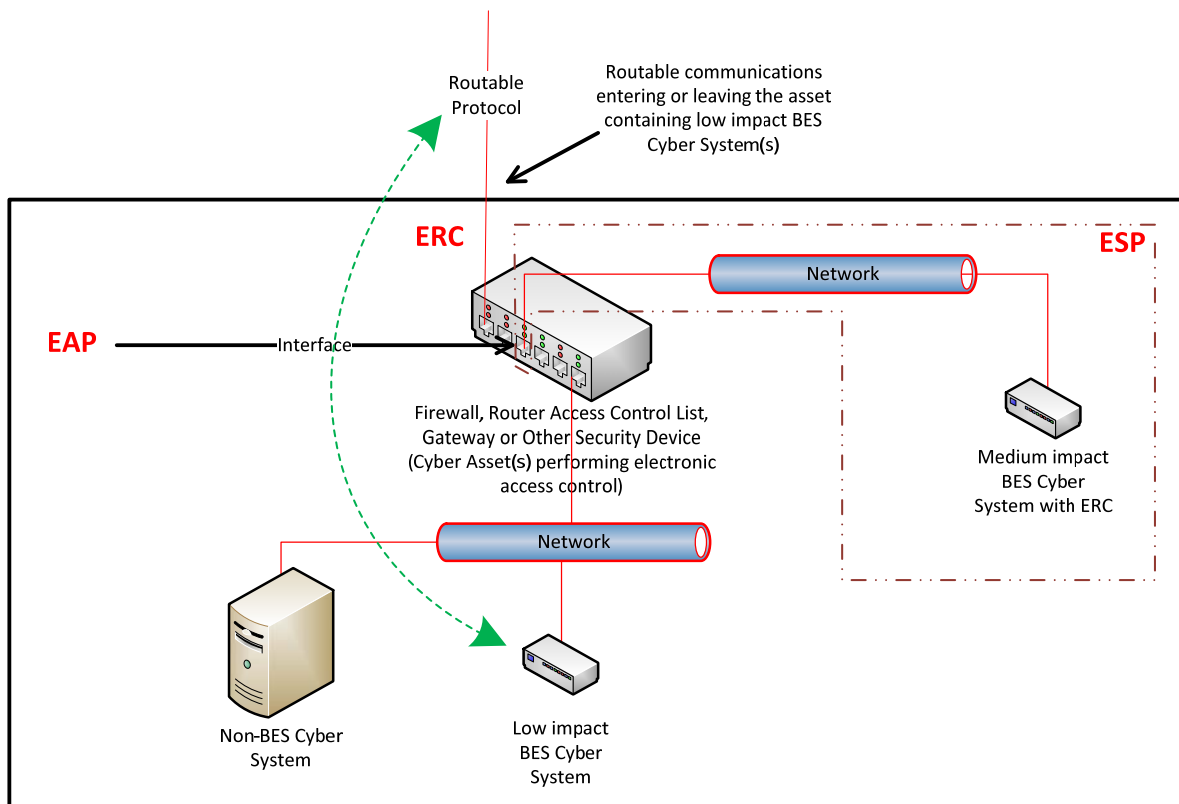

Asset containing low impact BES Cyber System(s) and medium impact BES Cyber System(s)



Reference Model 7

**Reference Model 8 – Physical Isolation and Serial Non-routable Communications – No Electronic Access Controls Required**

In this reference model, the criteria from Attachment 1, Section 3.1 requiring the implementation of electronic access controls are not met. This reference model demonstrates three concepts:

- 1) The physical isolation of the low impact BES Cyber System(s) from the routable protocol communication entering or leaving the asset containing the low impact BES Cyber System(s), commonly referred to as an 'air gap', mitigates the need to implement the required electronic access controls;
- 2) The communication to the low impact BES Cyber System from a Cyber Asset outside the asset containing the low impact BES Cyber System(s) using only a serial non-routable protocol where such communication is entering or leaving the asset mitigates the need to implement the required electronic access controls.
- 3) The routable protocol communication between the low impact BES Cyber System(s) and other Cyber Asset(s), such as the second low impact BES Cyber System depicted, may exist without needing to implement the required electronic access controls so long as the routable protocol communications never leaves the asset containing the low impact BES Cyber System(s).

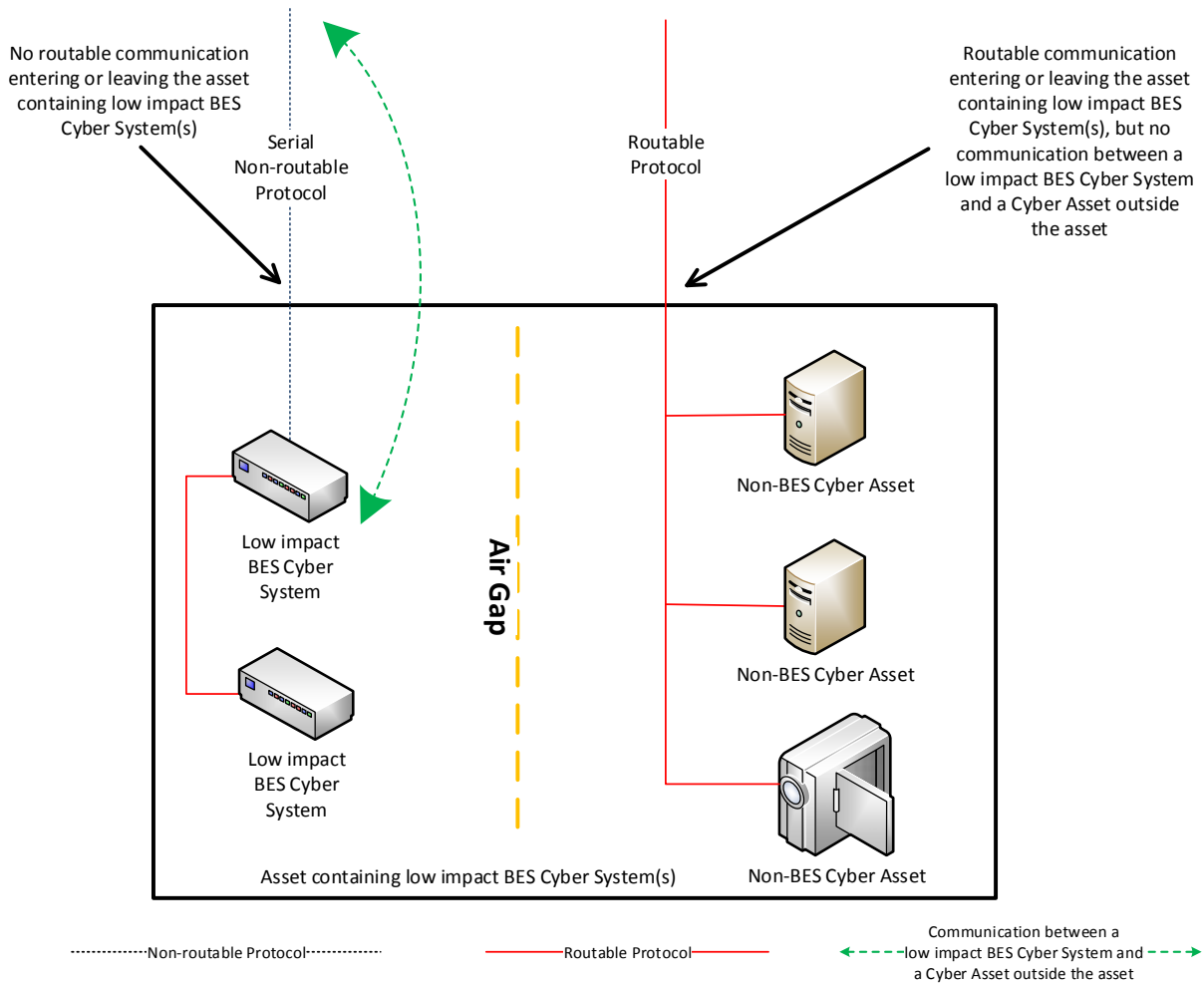

Reference Model 8

**Reference Model 9 – Logical Isolation - No Electronic Access Controls Required**

In this reference model, the criteria from Attachment 1, Section 3.1 requiring the implementation of electronic access controls are not met. The Responsible Entity has logically isolated the low impact BES Cyber System(s) from the routable protocol communication entering or leaving the asset containing low impact BES Cyber System(s). The logical network segmentation in this reference model permits no communication between a low impact BES Cyber System and a Cyber Asset outside the asset. Additionally, no indirect access exists because those non-BES Cyber Assets that are able to communicate outside the asset are strictly prohibited from communicating to the low impact BES Cyber System(s). The low impact BES Cyber System(s) is on an isolated network segment with logical controls preventing routable protocol communication into or out of the network containing the low impact BES Cyber System(s) and these communications never leave the asset using a routable protocol.

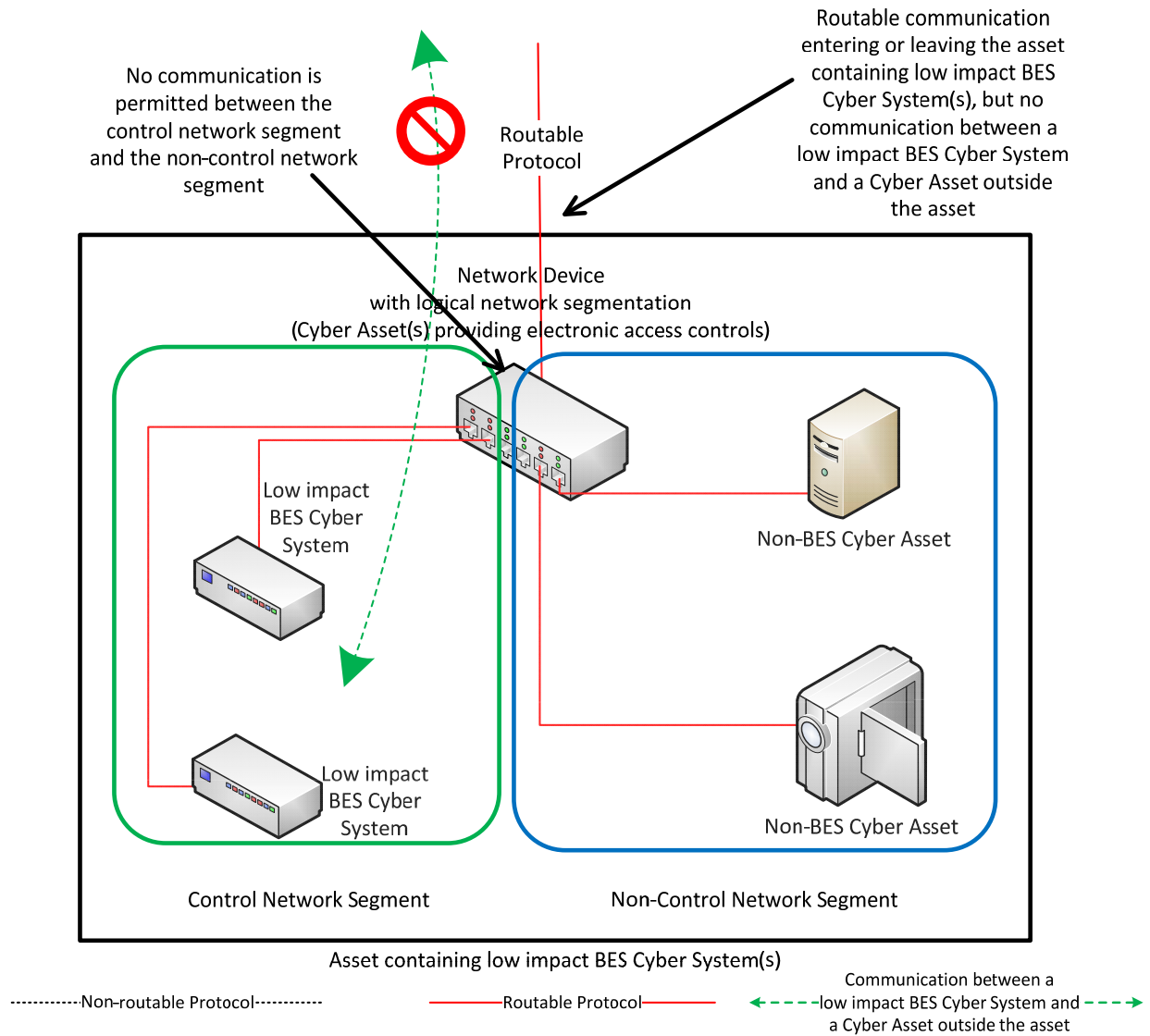

Reference Model 9



**Reference Model 10 - Serial Non-routable Communications Traversing an Isolated Channel on a Non-routable Transport Network – No Electronic Access Controls Required**

In this reference model, the criteria from Attachment 1, Section 3.1 requiring the implementation of electronic access controls are not met. This reference model depicts communication between a low impact BES Cyber System and a Cyber Asset outside the asset containing the low impact BES Cyber System over a serial non-routable protocol which is transported across a wide-area network using a protocol independent transport that may carry routable and non-routable communication such as a Time-Division Multiplexing (TDM) network, a Synchronous Optical Network (SONET), or a Multiprotocol Label Switching (MPLS) network. While there is routable protocol communication entering or leaving the asset containing low impact BES Cyber Systems(s) and there is communication between a low impact BES Cyber System and a Cyber Asset outside the asset, the communication between the low impact BES Cyber System and the Cyber Asset outside the asset is not using the routable protocol communication. This model is related to Reference Model 9 in that it relies on logical isolation to prohibit the communication between a low impact BES Cyber System and a Cyber Asset outside the asset from using a routable protocol.

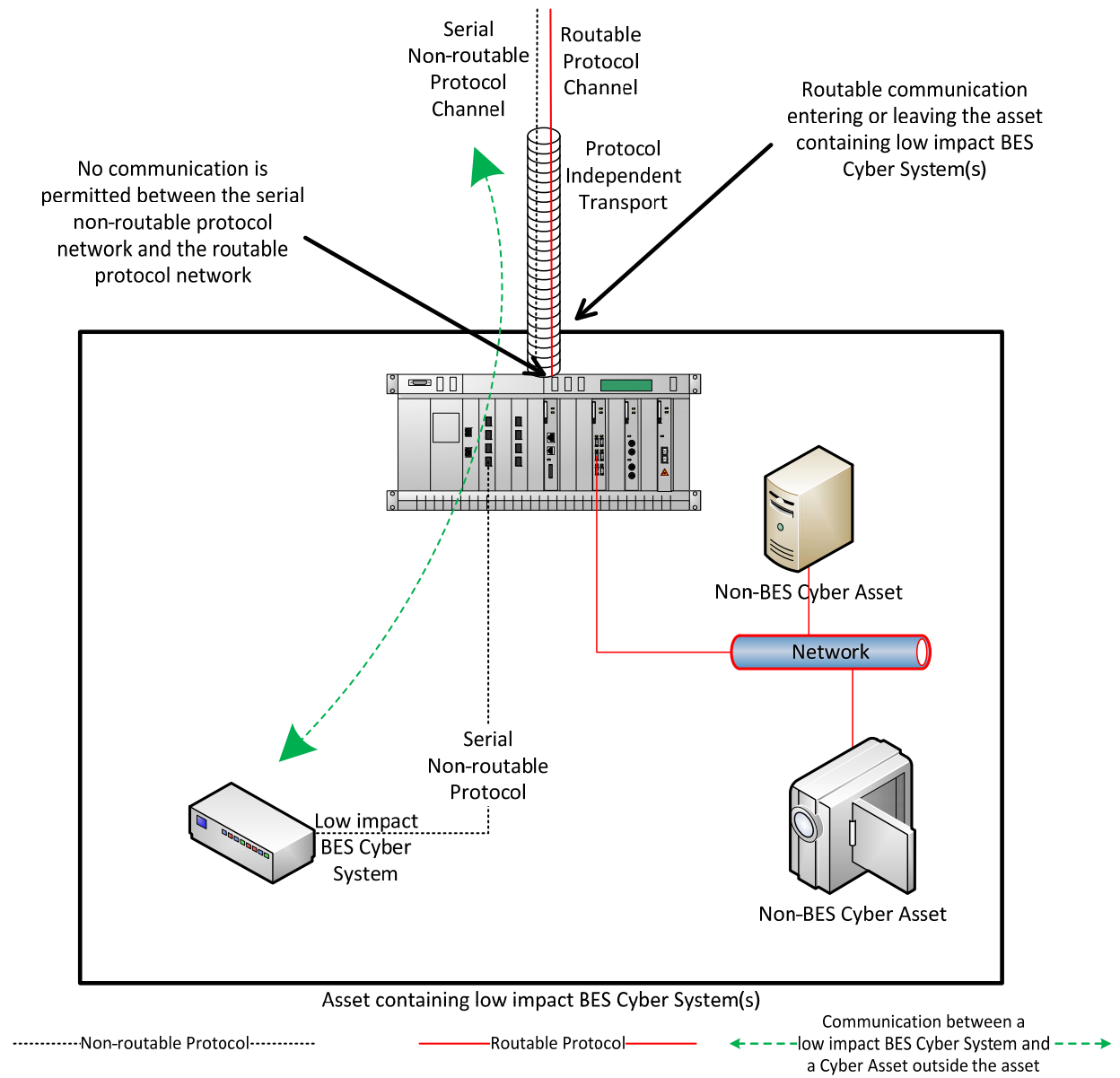

Reference Model 10

### **Dial-up Connectivity**

Dial-up Connectivity to a low impact BES Cyber System is set to dial out only (no auto-answer) to a preprogrammed number to deliver data. Incoming Dial-up Connectivity is to a dialback modem, a modem that must be remotely controlled by the control center or control room, has some form of access control, or the low impact BES Cyber System has access control.

### **Insufficient Access Controls**

Some examples of situations that would lack sufficient access controls to meet the intent of this requirement include:

- An asset has Dial-up Connectivity and a low impact BES Cyber System is reachable via an auto-answer modem that connects any caller to the Cyber Asset that has a default password. There is no practical access control in this instance.
- A low impact BES Cyber System has a wireless card on a public carrier that allows the BES Cyber System to be reachable via a public IP address. In essence, low impact BES Cyber Systems should not be accessible from the Internet and search engines such as Shodan.
- Dual-homing or multiple-network interface cards without disabling IP forwarding in the non-BES Cyber Asset within the DMZ to provide separation between the low impact BES Cyber System(s) and the external network would not meet the intent of “controlling” inbound and outbound electronic access assuming there was no other host-based firewall or other security devices on the non-BES Cyber Asset.

### **Requirement R2, Attachment 1, Section 4 – Cyber Security Incident Response**

The entity should have one or more documented Cyber Security Incident response plan(s) that include each of the topics listed in Section 4. If, in the normal course of business, suspicious activities are noted at an asset containing low impact BES Cyber System(s), the intent is for the entity to implement a Cyber Security Incident response plan that will guide the entity in responding to the incident and reporting the incident if it rises to the level of a Reportable Cyber Security Incident.

Entities are provided the flexibility to develop their Attachment 1, Section 4 Cyber Security Incident response plan(s) by asset or group of assets. The plans do not need to be on a per asset site or per low impact BES Cyber System basis. Entities can choose to use a single enterprise-wide plan to fulfill the obligations for low impact BES Cyber Systems.

The plan(s) must be tested once every 36 months. This is not an exercise per low impact BES Cyber Asset or per type of BES Cyber Asset but rather is an exercise of each incident response plan the entity created to meet this requirement. An actual Reportable Cyber Security Incident counts as an exercise as do other forms of tabletop exercises or drills. NERC-led exercises such as GridEx participation would also count as an exercise provided the entity’s response plan is followed. The intent of the requirement is for entities to keep the Cyber Security Incident response plan(s) current, which includes updating the plan(s), if needed, within 180 days following a test or an actual incident.

For low impact BES Cyber Systems, the only portion of the definition of Cyber Security Incident that would apply is, “A malicious act or suspicious event that disrupts, or was an attempt to

disrupt, the operation of a BES Cyber System.” The other portion of that definition is not to be used to require ESPs and PSPs for low impact BES Cyber Systems.

**Requirement R2, Attachment 1, Section 5 – Transient Cyber Assets and Removable Media Malicious Code Risk Mitigation**

Most BES Cyber Assets and BES Cyber Systems are isolated from external public or untrusted networks, and therefore Transient Cyber Assets and Removable Media are needed to transport files to and from secure areas to maintain, monitor, or troubleshoot critical systems. Transient Cyber Assets and Removable Media are a potential means for cyber-attack. To protect the BES Cyber Assets and BES Cyber Systems, CIP-003 Requirement R2, Attachment 1, Section 5 requires Responsible Entities to document and implement a plan for how they will mitigate the risk of malicious code introduction to low impact BES Cyber Systems from Transient Cyber Assets and Removable Media. The approach of defining a plan allows the Responsible Entity to document processes that are supportable within its organization and in alignment with its change management processes.

Transient Cyber Assets can be one of many types of devices from a specially-designed device for maintaining equipment in support of the BES to a platform such as a laptop, desktop, or tablet that may interface with or run applications that support BES Cyber Systems and is capable of transmitting executable code to the BES Cyber Asset(s) or BES Cyber System(s). Note: Cyber Assets connected to a BES Cyber System for less than 30 days due to an unplanned removal, such as premature failure, are not intended to be identified as Transient Cyber Assets. Removable Media subject to this requirement include, among others, floppy disks, compact disks, USB flash drives, external hard drives, and other flash memory cards/drives that contain nonvolatile memory.

Examples of these temporarily connected devices include, but are not limited to:

- Diagnostic test equipment;
- Equipment used for BES Cyber System maintenance; or
- Equipment used for BES Cyber System configuration.

To meet the objective of mitigating risks associated with the introduction of malicious code at low impact BES Cyber Systems, Section 5 specifies the capabilities and possible security methods available to Responsible Entities based upon asset type and ownership.

With the list of options provided in Attachment 1, the entity has the discretion to use the option(s) that is most appropriate. This includes documenting its approach for how and when the entity reviews the Transient Cyber Asset under its control or under the control of parties other than the Responsible Entity. The entity should avoid implementing a security function that jeopardizes reliability by taking actions that would negatively impact the performance or support of the Transient Cyber Asset or BES Cyber Asset.

### Malicious Code Risk Mitigation

The terms “mitigate”, “mitigating”, and “mitigation” are used in Section 5 in Attachment 1 to address the risks posed by malicious code when connecting Transient Cyber Assets and Removable Media to BES Cyber Systems. Mitigation is intended to mean that entities reduce security risks presented by connecting the Transient Cyber Asset or Removable Media. When determining the method(s) to mitigate the introduction of malicious code, it is not intended for entities to perform and document a formal risk assessment associated with the introduction of malicious code.

### Per Transient Cyber Asset Capability

As with other CIP standards, the requirements are intended for an entity to use the method(s) that the system is capable of performing. The use of “per Transient Cyber Asset capability” is to eliminate the need for a Technical Feasibility Exception when it is understood that the device cannot use a method(s). For example, for malicious code, many types of appliances are not capable of implementing antivirus software; therefore, because it is not a capability of those types of devices, implementation of the antivirus software would not be required for those devices.

### **Requirement R2, Attachment 1, Section 5.1 - Transient Cyber Asset(s) Managed by the Responsible Entity**

For Transient Cyber Assets and Removable Media that are connected to both low impact and medium/high impact BES Cyber Systems, entities must be aware of the differing levels of requirements and manage these assets under the program that matches the highest impact level to which they will connect.

**Section 5.1:** Entities are to document and implement their plan(s) to mitigate malicious code through the use of one or more of the protective measures listed, based on the capability of the Transient Cyber Asset.

The Responsible Entity has the flexibility to apply the selected method(s) to meet the objective of mitigating the introductions of malicious code either in an on-going or in an on-demand manner. An example of managing a device in an on-going manner is having the antivirus solution for the device managed as part of an end-point security solution with current signature or pattern updates, regularly scheduled systems scans, etc. In contrast, for devices that are used infrequently and the signatures or patterns are not kept current, the entity may manage those devices in an on-demand manner by requiring an update to the signatures or patterns and a scan of the device before the device is connected to ensure that it is free of malicious code.

Selecting management in an on-going or on-demand manner is not intended to imply that the control has to be verified at every single connection. For example, if the device is managed in an on-demand manner, but will be used to perform maintenance on several BES Cyber Asset(s), the Responsible Entity may choose to document that the Transient Cyber Asset has been updated before being connected as a Transient Cyber Asset for the first use of that maintenance work. The intent is not to require a log documenting each connection of a Transient Cyber Asset to a BES Cyber Asset.

The following is additional discussion of the methods to mitigate the introduction of malicious code.

- Antivirus software, including manual or managed updates of signatures or patterns, provides flexibility to manage Transient Cyber Asset(s) by deploying antivirus or endpoint security tools that maintain a scheduled update of the signatures or patterns. Also, for devices that do not regularly connect to receive scheduled updates, entities may choose to update the signatures or patterns and scan the Transient Cyber Asset prior to connection to ensure no malicious software is present.
- Application whitelisting is a method of authorizing only the applications and processes that are necessary on the Transient Cyber Asset. This reduces the risk that malicious software could execute on the Transient Cyber Asset and impact the BES Cyber Asset or BES Cyber System.
- When using methods other than those listed, entities need to document how the other method(s) meet the objective of mitigating the risk of the introduction of malicious code.

If malicious code is discovered on the Transient Cyber Asset, it must be mitigated prior to connection to a BES Cyber System to prevent the malicious code from being introduced into the BES Cyber System. An entity may choose to not connect the Transient Cyber Asset to a BES Cyber System to prevent the malicious code from being introduced into the BES Cyber System. Entities should also consider whether the detected malicious code is a Cyber Security Incident.

**Requirement R2, Attachment 1, Section 5.2 - Transient Cyber Asset(s) Managed by a Party Other than the Responsible Entity**

Section 5 also recognizes the lack of direct control over Transient Cyber Assets that are managed by parties other than the Responsible Entity. This lack of control, however, does not obviate the Responsible Entity's responsibility to ensure that methods have been deployed to mitigate the introduction of malicious code to low impact BES Cyber System(s) from Transient Cyber Assets it does not manage. Section 5 requires entities to review the other party's security practices with respect to Transient Cyber Assets to help meet the objective of the requirement. The use of "prior to connecting the Transient Cyber Assets" is intended to ensure that the Responsible Entity conducts the review before the first connection of the Transient Cyber Asset to help meet the objective to mitigate the introduction of malicious code. The SDT does not intend for the Responsible Entity to conduct a review for every single connection of that Transient Cyber Asset once the Responsible Entity has established the Transient Cyber Asset is meeting the security objective. The intent is to not require a log documenting each connection of a Transient Cyber Asset to a BES Cyber Asset.

To facilitate these controls, Responsible Entities may execute agreements with other parties to provide support services to BES Cyber Systems and BES Cyber Assets that may involve the use of Transient Cyber Assets. Entities may consider using the Department of Energy Cybersecurity Procurement Language for Energy Delivery dated April 2014.<sup>1</sup> Procurement language may unify

---

<sup>1</sup> <http://www.energy.gov/oe/downloads/cybersecurity-procurement-language-energy-delivery-april-2014>

the other party and entity actions supporting the BES Cyber Systems and BES Cyber Assets. CIP program attributes may be considered including roles and responsibilities, access controls, monitoring, logging, vulnerability, and patch management along with incident response and back up recovery may be part of the other party's support. Entities may consider the "General Cybersecurity Procurement Language" and "The Supplier's Life Cycle Security Program" when drafting Master Service Agreements, Contracts, and the CIP program processes and controls.

**Section 5.2.1:** Entities are to document and implement their process(es) to mitigate the introduction of malicious code through the use of one or more of the protective measures listed.

- Review the use of antivirus software and signature or pattern levels to ensure that the level is adequate to the Responsible Entity to mitigate the risk of malicious software being introduced to an applicable system.
- Review the antivirus or endpoint security processes of the other party to ensure that their processes are adequate to the Responsible Entity to mitigate the risk of introducing malicious software to an applicable system.
- Review the use of application whitelisting used by the other party to mitigate the risk of introducing malicious software to an applicable system.
- Review the use of live operating systems or software executable only from read-only media to ensure that the media is free from malicious software itself. Entities should review the processes to build the read-only media as well as the media itself.
- Review system hardening practices used by the other party to ensure that unnecessary ports, services, applications, etc. have been disabled or removed. This method intends to reduce the attack surface on the Transient Cyber Asset and reduce the avenues by which malicious software could be introduced.

**Section 5.2.2:** The intent of this section is to ensure that after conducting the selected review from Section 5.2.1, if there are deficiencies identified, actions mitigating the risk of the introduction of malicious code to low impact BES Cyber Systems must be completed prior to connecting the device(s) to an applicable system.

### **Requirement R2, Attachment 1, Section 5.3 - Removable Media**

Entities have a high level of control for Removable Media that are going to be connected to their BES Cyber Assets.

**Section 5.3:** Entities are to document and implement their process(es) to mitigate the introduction of malicious code through the use of one or more method(s) to detect malicious code on the Removable Media before it is connected to a BES Cyber Asset. When using the method(s) to detect malicious code, it is expected to occur from a system that is not part of the BES Cyber System to reduce the risk of propagating malicious code into the BES Cyber System

network or onto one of the BES Cyber Assets. If malicious code is discovered, it must be removed or mitigated to prevent it from being introduced into the BES Cyber Asset or BES Cyber System. Entities should also consider whether the detected malicious code is a Cyber Security Incident. Frequency and timing of the methods used to detect malicious code were intentionally excluded from the requirement because there are multiple timing scenarios that can be incorporated into a plan to mitigate the risk of malicious code. The SDT does not intend to obligate a Responsible Entity to conduct a review for every single connection of Removable Media, but rather to implement its plan(s) in a manner that protects all BES Cyber Systems where Removable Media may be used. The intent is to not require a log documenting each connection of Removable Media to a BES Cyber Asset.

As a method to detect malicious code, entities may choose to use Removable Media with on-board malicious code detection tools. For these tools, the Removable Media are still used in conjunction with a Cyber Asset to perform the detection. For Section 5.3.1, the Cyber Asset used to perform the malicious code detection must be outside of the BES Cyber System.

### **Requirement R3:**

The intent of CIP-003-78, Requirement R3 is effectively unchanged since prior versions of the standard. The specific description of the CIP Senior Manager has now been included as a defined term rather than clarified in the Reliability Standard itself to prevent any unnecessary cross-reference to this standard. It is expected that the CIP Senior Manager will play a key role in ensuring proper strategic planning, executive/board-level awareness, and overall program governance.

### **Requirement R4:**

As indicated in the rationale for CIP-003-78, Requirement R4, this requirement is intended to demonstrate a clear line of authority and ownership for security matters. The intent of the SDT was not to impose any particular organizational structure, but, rather, the intent is to afford the Responsible Entity significant flexibility to adapt this requirement to its existing organizational structure. A Responsible Entity may satisfy this requirement through a single delegation document or through multiple delegation documents. The Responsible Entity can make use of the delegation of the delegation authority itself to increase the flexibility in how this applies to its organization. In such a case, delegations may exist in numerous documentation records as long as the collection of these documentation records shows a clear line of authority back to the CIP Senior Manager. In addition, the CIP Senior Manager could also choose not to delegate any authority and meet this requirement without such delegation documentation.

The Responsible Entity must keep its documentation of the CIP Senior Manager and any delegations up-to-date. This is to ensure that individuals do not assume any undocumented authority. However, delegations do not have to be re-instated if the individual who delegated the task changes roles or the individual is replaced. For instance, assume that John Doe is named the CIP Senior Manager and he delegates a specific task to the Substation Maintenance Manager. If John Doe is replaced as the CIP Senior Manager, the CIP Senior Manager documentation must be updated within the specified timeframe, but the existing delegation to



the Substation Maintenance Manager remains in effect as approved by the previous CIP Senior Manager, John Doe.

**Rationale:**

During development of this standard, text boxes were embedded within the standard to explain the rationale for various parts of the standard. Upon BOT approval, the text from the rationale text boxes was moved to this section.

**Rationale for Requirement R1:**

One or more security policies enable effective implementation of the requirements of the cyber security Reliability Standards. The purpose of policies is to provide a management and governance foundation for all requirements that apply to a Responsible Entity's BES Cyber Systems. The Responsible Entity can demonstrate through its policies that its management supports the accountability and responsibility necessary for effective implementation of the requirements.

Annual review and approval of the cyber security policies ensures that the policies are kept-up-to-date and periodically reaffirms management's commitment to the protection of its BES Cyber Systems.

**Rationale for Requirement R2:**

In response to FERC Order No. 791, Requirement R2 requires entities to develop and implement cyber security plans to meet specific security control objectives for assets containing low impact BES Cyber System(s). The cyber security plan(s) covers five subject matter areas: (1) cyber security awareness; (2) physical security controls; (3) electronic access controls; (4) Cyber Security Incident response; and (5) Transient Cyber Asset and Removable Media Malicious Code Risk Mitigation. This plan(s), along with the cyber security policies required under Requirement R1, Part 1.2, provides a framework for operational, procedural, and technical safeguards for low impact BES Cyber Systems.

Considering the varied types of low impact BES Cyber Systems across the BES, Attachment 1 provides Responsible Entities flexibility on how to apply the security controls to meet the security objectives. Additionally, because many Responsible Entities have multiple-impact rated BES Cyber Systems, nothing in the requirement prohibits entities from using their high and medium impact BES Cyber System policies, procedures, and processes to implement security controls required for low impact BES Cyber Systems, as detailed in Requirement R2, Attachment 1.

Responsible Entities will use their identified assets containing low impact BES Cyber System(s) (developed pursuant to CIP-002) to substantiate the sites or locations associated with low impact BES Cyber System(s). However, there is no requirement or compliance expectation for Responsible Entities to maintain a list(s) of individual low impact BES Cyber System(s) and their associated cyber assets or to maintain a list of authorized users.

**Rationale for Modifications to Sections 2 and 3 of Attachment 1 (Requirement R2):**

Requirement R2 mandates that entities develop and implement one or more cyber security plan(s) to meet specific security objectives for assets containing low impact BES Cyber System(s). In Paragraph 73 of FERC Order No. 822, the Commission directed NERC to modify "...the Low Impact External Routable Connectivity definition to reflect the commentary in the Guidelines and Technical Basis section of CIP-003-6...to provide needed clarity to the definition

and eliminate ambiguity surrounding the term ‘direct’ as it is used in the proposed definition...within one year of the effective date of this Final Rule.”

The revisions to Section 3 incorporate select language from the LERC definition into Attachment 1 and focus the requirement on implementing electronic access controls for asset(s) containing low impact BES Cyber System(s). This change requires the Responsible Entity to permit only necessary inbound and outbound electronic access when using a routable protocol entering or leaving the asset between low impact BES Cyber System(s) and a Cyber Asset(s) outside the asset containing low impact BES Cyber system(s). When this communication is present, Responsible Entities are required to implement electronic access controls unless that communication meets the following exclusion language (previously in the definition of LERC) contained in romanette (iii): “not used for time-sensitive protection or control functions between intelligent electronic devices (e.g. communications using protocol IEC TR-61850-90-5 R-GOOSE)”.

The revisions to Section 2 of Attachment 1 complement the revisions to Section 3; consequently, the requirement now mandates the Responsible Entity control physical access to “the Cyber Asset(s), as specified by the Responsible Entity, that provide electronic access control(s) implemented for Section 3.1, if any.” The focus on electronic access controls rather than on the Low Impact BES Cyber System Electronic Access Points (LEAPs) eliminates the need for LEAPs.

Given these revisions to Sections 2 and 3, the NERC Glossary terms: Low Impact External Routable Connectivity (LERC) and Low Impact BES Cyber System Electronic Access Point (LEAP) will be retired.

**Rationale for Section 5 of Attachment 1 (Requirement R2):**

Requirement R2 mandates that entities develop and implement one or more cyber security plan(s) to meet specific security objectives for assets containing low impact BES Cyber System(s). In Paragraph 32 of FERC Order No. 822, the Commission directed NERC to “...provide mandatory protection for transient devices used at Low Impact BES Cyber Systems based on the risk posed to bulk electric system reliability.” Transient devices are potential vehicles for introducing malicious code into low impact BES Cyber Systems. Section 5 of Attachment 1 is intended to mitigate the risk of malware propagation to the BES through low impact BES Cyber Systems by requiring entities to develop and implement one or more plan(s) to address the risk. The cyber security plan(s) along with the cyber security policies required under Requirement R1, Part 1.2, provide a framework for operational, procedural, and technical safeguards for low impact BES Cyber Systems.

**Rationale for Requirement R3:**

The identification and documentation of the single CIP Senior Manager ensures that there is clear authority and ownership for the CIP program within an organization, as called for in Blackout Report Recommendation 43. The language that identifies CIP Senior Manager responsibilities is included in the Glossary of Terms used in NERC Reliability Standards so that it may be used across the body of CIP standards without an explicit cross-reference.

FERC Order No. 706, Paragraph 296, requests consideration of whether the single senior manager should be a corporate officer or equivalent. As implicated through the defined term, the senior manager has “the overall authority and responsibility for leading and managing implementation of the requirements within this set of standards” which ensures that the senior manager is of sufficient position in the Responsible Entity to ensure that cyber security receives the prominence that is necessary. In addition, given the range of business models for responsible entities, from municipal, cooperative, federal agencies, investor owned utilities, privately owned utilities, and everything in between, the SDT believes that requiring the CIP Senior Manager to be a “corporate officer or equivalent” would be extremely difficult to interpret and enforce on a consistent basis.

**Rationale for Requirement R4:**

The intent of the requirement is to ensure clear accountability within an organization for certain security matters. It also ensures that delegations are kept up-to-date and that individuals do not assume undocumented authority.

In FERC Order No. 706, Paragraphs 379 and 381, the Commission notes that Recommendation 43 of the 2003 Blackout Report calls for “clear lines of authority and ownership for security matters.” With this in mind, the Standard Drafting Team has sought to provide clarity in the requirement for delegations so that this line of authority is clear and apparent from the documented delegations.

**Exhibit B**  
**Implementation Plan**

# Implementation Plan

## Project 2016-02 Modifications to CIP Standards Reliability Standard CIP-003-8 - Cyber Security – Security Management Controls

### Applicable Standard

- Reliability Standard CIP-003-8 - Cyber Security – Security Management Controls

### Requested Retirements

- Reliability Standard CIP-003-7 - Cyber Security – Security Management Controls

### Applicable Entities

- Balancing Authority
- Distribution Provider
- Generator Operator
- Generator Owner
- Reliability Coordinator
- Transmission Operator
- Transmission Owner

### Background

On April 19, 2018, the Federal Energy Regulatory Commission (the “Commission”) issued Order No. 843, approving CIP-003-7. In that Order, the Commission also directed NERC to “develop and submit modifications to Reliability Standard CIP-003-7 to include an explicit requirement that responsible entities implement controls to mitigate the risk of malicious code that could result from third-party transient electronic devices.”

### Effective Dates

#### Reliability Standard CIP-003-8

Where approval by an applicable governmental authority is required, Reliability Standard CIP-003-8 shall become effective on the later of (1) January 1, 2020, or (2) the first day of the first calendar quarter that is six (6) calendar months after the effective date of the applicable governmental authority’s order approving the standard, or as otherwise provided for by the applicable governmental authority.

Where approval by an applicable governmental authority is not required, Reliability Standard CIP-003-8 shall become effective on the later of (1) January 1, 2020, or (2) the first day of the first

calendar quarter that is six (6) calendar months after the date the standard is adopted by the NERC Board of Trustees, or as otherwise provided for in that jurisdiction.

### **Planned or Unplanned Changes**

This Implementation Plan incorporates by reference the section in the [Implementation Plan](#) associated with CIP-003-7 titled Planned or Unplanned Changes.

Note that NERC is currently developing provisions related to Planned or Unplanned Changes to be included in the CIP-002 standard that would apply to all applicable CIP Reliability Standards and would supersede the Planned and Unplanned Changes provisions in the Implementation Plan associated with CIP-003-7.

### **Retirement Date**

#### **Reliability Standard CIP-003-7**

Reliability Standard CIP-003-7 shall be retired immediately prior to the effective date of Reliability Standard CIP-003-8 in the particular jurisdiction in which the revised standard is becoming effective.

**Exhibit D**

**Analysis of Violation Risk Factors and Violation Severity Levels**



# Violation Risk Factor and Violation Severity Level Justifications

## Project 2016-02 – Modifications to CIP Standards

This document provides the standard drafting team's (SDT's) justification for assignment of the violation risk factor (VRF) and violation severity levels (VSLs) in proposed NERC Reliability Standard CIP-003-8 — Cyber Security — Security Management Controls. These elements support the determination of an initial value range for the Base Penalty Amount regarding violations of requirements in FERC-approved Reliability Standards, as defined in the Electric Reliability Organizations (ERO) Sanction Guidelines. The SDT applied the following NERC criteria and FERC Guidelines when developing the VRFs and VSLs for the requirements.

### **NERC Criteria for Violation Risk Factors**

#### **High Risk Requirement**

A requirement that, if violated, could directly cause or contribute to Bulk Electric System instability, separation, or a cascading sequence of failures, or could place the Bulk Electric System at an unacceptable risk of instability, separation, or cascading failures; or, a requirement in a planning time frame that, if violated, could, under emergency, abnormal, or restorative conditions anticipated by the preparations, directly cause or contribute to Bulk Electric System instability, separation, or a cascading sequence of failures, or could place the Bulk Electric System at an unacceptable risk of instability, separation, or cascading failures, or could hinder restoration to a normal condition.

#### **Medium Risk Requirement**

A requirement that, if violated, could directly affect the electrical state or the capability of the Bulk Electric System, or the ability to effectively monitor and control the Bulk Electric System. However, violation of a medium risk requirement is unlikely to lead to Bulk Electric System instability, separation, or cascading failures; or, a requirement in a planning time frame that, if violated, could, under emergency, abnormal, or restorative conditions anticipated by the preparations, directly and adversely affect the electrical state or capability of the Bulk Electric System, or the ability to effectively monitor, control, or restore the Bulk Electric System. However, violation of a medium risk requirement is unlikely, under emergency, abnormal, or restoration conditions anticipated by the preparations, to lead to Bulk Electric System instability, separation, or cascading failures, nor to hinder restoration to a normal condition.

### **Lower Risk Requirement**

A requirement that is administrative in nature and a requirement that, if violated, would not be expected to adversely affect the electrical state or capability of the Bulk Electric System, or the ability to effectively monitor and control the Bulk Electric System; or, a requirement that is administrative in nature and a requirement in a planning time frame that, if violated, would not, under the emergency, abnormal, or restorative conditions anticipated by the preparations, be expected to adversely affect the electrical state or capability of the Bulk Electric System, or the ability to effectively monitor, control, or restore the Bulk Electric System.

## **FERC Guidelines for Violation Risk Factors**

### **Guideline (1) – Consistency with the Conclusions of the Final Blackout Report**

FERC seeks to ensure that VRFs assigned to Requirements of Reliability Standards in these identified areas appropriately reflect their historical critical impact on the reliability of the Bulk-Power System. In the VSL Order, FERC listed critical areas (from the Final Blackout Report) where violations could severely affect the reliability of the Bulk-Power System:

- Emergency operations
- Vegetation management
- Operator personnel training
- Protection systems and their coordination
- Operating tools and backup facilities
- Reactive power and voltage control
- System modeling and data exchange
- Communication protocol and facilities
- Requirements to determine equipment ratings
- Synchronized data recorders
- Clearer criteria for operationally critical facilities
- Appropriate use of transmission loading relief.

**Guideline (2) – Consistency within a Reliability Standard**

FERC expects a rational connection between the sub-Requirement VRF assignments and the main Requirement VRF assignment.

**Guideline (3) – Consistency among Reliability Standards**

FERC expects the assignment of VRFs corresponding to Requirements that address similar reliability goals in different Reliability Standards would be treated comparably.

**Guideline (4) – Consistency with NERC’s Definition of the Violation Risk Factor Level**

Guideline (4) was developed to evaluate whether the assignment of a particular VRF level conforms to NERC’s definition of that risk level.

**Guideline (5) – Treatment of Requirements that Co-mingle More Than One Obligation**

Where a single Requirement co-mingles a higher risk reliability objective and a lesser risk reliability objective, the VRF assignment for such Requirements must not be watered down to reflect the lower risk level associated with the less important objective of the Reliability Standard.

**NERC Criteria for Violation Severity Levels**

VSLs define the degree to which compliance with a requirement was not achieved. Each requirement must have at least one VSL. While it is preferable to have four VSLs for each requirement, some requirements do not have multiple “degrees” of noncompliant performance and may have only one, two, or three VSLs.

VSLs should be based on NERC’s overarching criteria shown in the table below:

Lower VSL	Moderate VSL	High VSL	Severe VSL
The performance or product measured almost meets the full intent of the requirement.	The performance or product measured meets the majority of the intent of the requirement.	The performance or product measured does not meet the majority of the intent of the requirement, but does meet some of the intent.	The performance or product measured does not substantively meet the intent of the requirement.

**FERC Order of Violation Severity Levels**

The FERC VSL guidelines are presented below, followed by an analysis of whether the VSLs proposed for each requirement in the standard meet the FERC Guidelines for assessing VSLs:

**Guideline (1) – Violation Severity Level Assignments Should Not Have the Unintended Consequence of Lowering the Current Level of Compliance**

Compare the VSLs to any prior levels of non-compliance and avoid significant changes that may encourage a lower level of compliance than was required when levels of non-compliance were used.

**Guideline (2) – Violation Severity Level Assignments Should Ensure Uniformity and Consistency in the Determination of Penalties**

A violation of a “binary” type requirement must be a “Severe” VSL.  
Do not use ambiguous terms such as “minor” and “significant” to describe noncompliant performance.

**Guideline (3) – Violation Severity Level Assignment Should Be Consistent with the Corresponding Requirement**

VSLs should not expand on what is required in the requirement.

**Guideline (4) – Violation Severity Level Assignment Should Be Based on A Single Violation, Not on A Cumulative Number of Violations**

Unless otherwise stated in the requirement, each instance of non-compliance with a requirement is a separate violation. Section 4 of the Sanction Guidelines states that assessing penalties on a per violation per day basis is the “default” for penalty calculations.

- **Requirement R1: No changes made to the VRF or VSL.**
- **Requirement R2: No changes made to the VRF or VSL.**
- **Requirement R3: No changes made to the VRF or VSL.**
- **Requirement R4: No changes made to the VRF or VSL.**

**Exhibit E**

**Summary of Development History and Complete Record of Development**

## **Summary of Development History**

## Summary of Development History

The following is a summary of the development record for proposed Reliability Standard CIP-003-8.

### **I. Overview of the Standard Drafting Team**

Pursuant to Section 215(d)(2) of the Federal Power Act, when evaluating a proposed Reliability Standard, the Commission is expected to give “due weight” to the technical expertise of the ERO.<sup>1</sup> The technical expertise of the ERO is derived from the standard drafting team (“SDT”) selected to lead each project in accordance with Section 4.3 of the NERC Standard Processes Manual.<sup>2</sup> For this project, the SDT consisted of industry experts, all with a diverse set of experiences. A roster of the Project 2016-02 – Modifications to CIP Standards SDT members is included in **Exhibit F**.

### **II. Standard Development History**

#### **A. Standard Authorization Request Development**

Project 2016-02 – Modifications to CIP Standards was initiated on July 20, 2016. After issuance of Order No. 843,<sup>3</sup> the Standards Committee on June 13, 2018 accepted a Standards Authorization Request (“SAR”) to address the Commission directive and authorized posting the SAR for a 30-day informal comment period from June 14, 2018 through July 13, 2018. The Standards Committee assigned the SAR to the Project 2016-02 SDT.

---

<sup>1</sup> 16 U.S.C. § 824o(d)(2) (2018).

<sup>2</sup> The NERC *Standard Processes Manual* is available at [https://www.nerc.com/FilingsOrders/us/RuleOfProcedureDL/SPM\\_Clean\\_Mar2019.pdf](https://www.nerc.com/FilingsOrders/us/RuleOfProcedureDL/SPM_Clean_Mar2019.pdf).

<sup>3</sup> *Revised Critical Infrastructure Protection Reliability Standard CIP-003-7 – Cyber Security – Security Management Controls*, Order No. 843, 163 FERC ¶ 61,032 (2018) (“Order No. 843”).



## **B. First Posting - Comment Period, Initial Ballot, and Non-binding Poll**

Proposed Reliability Standard CIP-003-8 and the associated Implementation Plan, Violation Risk Factors (“VRFs”), Violation Severity Levels (“VSLs”), and other associated documents were posted for a 45-day formal comment period from August 23, 2018 through October 9, 2018, with a parallel initial ballot and non-binding poll held during the last 10 days of the comment period from September 28, 2018 through October 9, 2018. The initial ballot for proposed CIP-003-8 received 90.06 percent approval, reaching quorum at 79.01 percent of the ballot pool. The non-binding poll for the associated VRFs and VSLs received 89.2 percent supportive opinions, reaching quorum at 75.57 percent of the ballot pool. There were 50 sets of responses, including comments from approximately 131 different individuals and approximately 92 companies, representing all 10 industry segments.<sup>4</sup>

## **C. Final Ballot**

Proposed Reliability Standard CIP-003-8 was posted for a 10-day final ballot period from April 18, 2019 through April 29, 2019. The ballot for proposed Reliability Standard CIP-003-8 and associated documents reached quorum at 83.64 percent of the ballot pool, receiving affirmative support from 91.44 percent of the voters.

## **D. Board of Trustees Adoption**

The NERC Board of Trustees adopted proposed Reliability Standard CIP-003-8 on May 9, 2019.<sup>5</sup>

---

<sup>4</sup> NERC, *Consideration of Comments – CIP-003-8*, Project 2016-02 Modifications to CIP Standards, [https://www.nerc.com/pa/Stand/Project%20201602%20Modifications%20to%20CIP%20Standards%20DL/2016-02\\_CIP-003-8\\_Consideration\\_of\\_Comments\\_04182019.pdf](https://www.nerc.com/pa/Stand/Project%20201602%20Modifications%20to%20CIP%20Standards%20DL/2016-02_CIP-003-8_Consideration_of_Comments_04182019.pdf).

<sup>5</sup> NERC, *Board of Trustees Agenda Package*, Agenda Item 5c (CIP-003-8 – Cyber Security – Security Management Controls), [https://www.nerc.com/gov/bot/Agenda%20highlights%20and%20Mintues%202013/Board\\_Open\\_Meeting\\_May\\_9\\_2019\\_Agenda\\_Package.pdf](https://www.nerc.com/gov/bot/Agenda%20highlights%20and%20Mintues%202013/Board_Open_Meeting_May_9_2019_Agenda_Package.pdf).

## **Complete Record of Development**

[Home](#) > [Program Areas & Departments](#) > [Standards](#) > [Project 2016-02 Modifications to CIP Standards](#)  
**Project 2016-02 Modifications to CIP Standards**

[Related Files](#)

### **Status**

The 10-day final ballot for **CIP-003-8 - Cyber Security - Security Management Controls** concluded **8 p.m. Eastern, Monday, April 29, 2019**. The standard will be submitted to the Board of Trustees for adoption and then filed with the appropriate regulatory authorities.

### **Background**

The Version 5 Transition Advisory Group (V5 TAG) transferred issues to the Version 5 SDT that were identified during the industry transition to implementation of the Version 5 CIP Standards. Specifically, the issues that the SDT will address are:

- Cyber Asset and BES Cyber Asset Definitions
- Network and Externally Accessible Devices
- Transmission Owner (TO) Control Centers Performing Transmission Operator (TOP) Obligations
- Virtualization

On January 21, 2016, FERC issued [Order No. 822](#) Revised Critical Infrastructure Protection Reliability Standards. In this order, FERC approved revisions to version 5 of the CIP standards and also directed that NERC address each of the Order 822 directives by developing modifications to requirements in CIP standards and the definition of Low Impact External Routable Connectivity (LERC), or the SDT shall develop an equally efficient and effective alternative. To address concerns identified in Order 822, the Commission directed the following:

- Develop modifications to the CIP Reliability Standards to provide mandatory protection for transient devices used at Low Impact BES Cyber Systems based on the risk posed to bulk electric system reliability.
- Develop modifications to the CIP Reliability Standards to require responsible entities to implement controls to protect, at a minimum, communication links and sensitive bulk electric system data communicated between bulk electric system Control Centers in a manner that is appropriately tailored to address the risks posed to the bulk electric system by the assets being protected (i.e., high, medium, or low impact).
- Develop a modification to provide the needed clarity, within one year of the effective date of this Final Rule, to the LERC definition consistent with the commentary in the Guidelines and Technical Basis section of CIP-003-6.

**Standard(s) Affected** – [CIP-002-5.1](#), [CIP-003-6](#), [CIP-004-6](#), [CIP-005-5](#), [CIP-006-6](#), [CIP-007-6](#), [CIP-008-5](#), [CIP-009-6](#), [CIP-010-2](#), [CIP-011-2](#), CIP-012-1

**Purpose/Industry Need**

The SDT will modify the CIP family of standards (or develop an equally efficient and effective alternative) to:

- Address issues identified by the CIP V5 TAG;
- Address FERC directives contained in Order 822; and
- Address requests for interpretations as directed by the NERC Standards

Draft	Actions	Dates	Results	Consideration of Comments
<p><b>Final Draft</b></p> <p>CIP-003-8  <a href="#">Clean (22)</a>   <a href="#">Redline to Last Posted (23)</a>  <a href="#">Redline to Last Approved (Updated) (24)</a></p> <p>Implementation Plan  <a href="#">Clean (25)</a>   <a href="#">Redline to Last Posted (26)</a></p> <p><b>Supporting Materials</b></p> <p>VRF/VSL Justification  <a href="#">Clean (27)</a>   <a href="#">Redline to Last Posted (28)</a></p>	<p>Final Ballot</p> <p><a href="#">Info (29)</a></p> <p><a href="#">Vote</a></p>	<p>04/18/19 - 04/29/19</p>	<p><a href="#">Ballot Results (30)</a></p>	
<p><b>Standard Drafting Team Nominations</b></p> <p><b>Supporting Materials</b>  <a href="#">Unofficial Nomination Form (Word) (20)</a></p>	<p>Nomination Period</p> <p><a href="#">Info (21)</a></p> <p><a href="#">Submit Nominations</a></p>	<p>02/28/19 - 03/29/19</p>		
<p><b>Draft 1</b></p> <p>CIP-003-8  <a href="#">Clean (9)</a>   <a href="#">Redline to Last Approved (10)</a></p> <p><a href="#">Implementation Plan (11)</a></p> <p><b>Supporting Materials</b>  <a href="#">Unofficial Comment Form (Word) (12)</a></p>	<p>Initial Ballot and Non-binding Poll</p> <p><a href="#">Info (14)</a></p> <p><a href="#">Vote</a></p> <hr/> <p>Comment Period</p> <p><a href="#">Info (17)</a></p> <p><a href="#">Submit Comments</a></p>	<p>09/28/18 - 10/09/18</p> <hr/> <p>08/23/18 - 10/09/18</p>	<p><a href="#">Ballot Results (15)</a></p> <p><a href="#">Non-binding Poll Results (16)</a></p> <hr/> <p><a href="#">Comments Received (18)</a></p>	<p><a href="#">Consideration of Comments (19)</a></p>

<a href="#">VRF/VSL Justification</a> <b>(13)</b>	<a href="#">Join Ballot Pools</a>	08/23/18 - 09/21/18		
<b>Standards Authorization Requests</b>  <a href="#">FERC Order No. 843 (Malicious Code Example)</a> <b>(5)</b>  <b>Supporting Materials</b>  <b>Unofficial Comment Forms (Word)</b>  <a href="#">FERC Order No. 843</a> <b>(6)</b>	Comment Periods  <a href="#">Info</a> <b>(7)</b>  <a href="#">Submit Comments</a>	06/14/18 - 07/13/18	Comments Received  <a href="#">FERC Order No. 843 (Malicious Code)</a> <b>(8)</b>	
<b>Standard Drafting Team Nominations</b>  <b>Supporting Materials</b>  <a href="#">Unofficial Nomination Form (Word)</a> <b>(3)</b>	Nomination Period  <a href="#">Info</a> <b>(4)</b>  <a href="#">Submit Nominations</a>	04/24/18 - 05/23/18		
<b>Supplemental Standard Drafting Team Nominations</b>  <b>Supporting Materials</b>  <a href="#">Unofficial Nomination Form (Word)</a> <b>(1)</b>	Nomination Period  <a href="#">Info</a> <b>(2)</b>  <a href="#">Submit Nominations</a>	03/10/16 - 03/23/16		

# Unofficial Nomination Form

## Project 2016-02 Modifications to CIP Standards

### Supplemental Nomination Period

Nominations for additional standard drafting team (SDT) members are being solicited for **Project 2016-02 Modifications to CIP Standards**. Use the [electronic form](#) to submit nominations by **8 p.m. Eastern, Wednesday, March 23, 2016**. This unofficial version is provided to assist nominees in compiling the information necessary to submit the electronic form.

Documents and information about this project are available on the [Project 2016-02 Modifications to CIP Standards](#) page. If you have questions, contact either Senior Standards Developer, [Stephen Crutchfield](#) at (609) 651-9455 or [Al McMeekin](#) at (404) 446-9675.

By submitting a nomination form, you are indicating your willingness and agreement to actively participate in face-to-face meetings and conference calls.

Previous drafting or review team experience is beneficial, but not required. A brief description of the desired qualifications, expected commitment, and other pertinent information is included below.

### Background

This solicitation for nominations is to supplement the existing Project 2016-02 Modifications to CIP Standards SDT that is continuing to address the work in the Project 2016-02 Modifications to CIP Standards Authorization Request (SAR). NERC is seeking individuals from the United States and Canada who possess experience in one or more of the following areas:

- Operations technology
- Communication networks
- Virtualization
- Protection of transient electronic devices
- Network and externally accessible devices
- Cyber Asset and BES Cyber Asset definitions
- Transmission Owner (TO) Control Centers
- Critical Infrastructure Protection (“CIP”) family of Reliability Standards

The time commitment for Project 2016-02 is expected to be significant. Participants should anticipate an average workload of 20 hours per week devoted to the drafting team efforts. In-person meetings will occur typically for 2 ½ - 3 days most months (not including travel time) and meetings will take place in different parts of North America. When not meeting in person, regularly scheduled

conference calls will be used to conduct drafting team work. Outside the scheduled meetings, individuals or subgroups will have additional preparation and support work such as researching and developing proposed concepts, reviewing proposals, compiling comments and drafting responses, etc. Lastly, outreach is an important component of this drafting team’s effort. Members of the team are expected to interact with other stakeholders during the revision development process.

<b>Name:</b>		
<b>Organization:</b>		
<b>Address:</b>		
<b>Telephone:</b>		
<b>E-mail:</b>		
<b>Please briefly describe your experience and qualifications to serve on the requested Standard Drafting Team (Bio):</b>		
<p><b>If you are currently a member of any NERC drafting team, please list each team here:</b></p> <p><input type="checkbox"/> Not currently on any active SAR or standard drafting team.</p> <p><input type="checkbox"/> Currently a member of the following SAR or standard drafting team(s):</p>		
<p><b>If you previously worked on any NERC drafting team please identify the team(s):</b></p> <p><input type="checkbox"/> No prior NERC SAR or standard drafting team.</p> <p><input type="checkbox"/> Prior experience on the following team(s):</p>		
<p><b>Select each NERC Region in which you have experience relevant to the Project for which you are volunteering:</b></p>		
<input type="checkbox"/> FRCC <input type="checkbox"/> MRO <input type="checkbox"/> NPCC	<input type="checkbox"/> RF <input type="checkbox"/> SERC <input type="checkbox"/> SPP RE	<input type="checkbox"/> Texas RE <input type="checkbox"/> WECC <input type="checkbox"/> NA – Not Applicable
<p><b>Select each Industry Segment that you represent:</b></p>		
<input type="checkbox"/>	1 — Transmission Owners	

<input type="checkbox"/>	2 — RTOs, ISOs
<input type="checkbox"/>	3 — Load-serving Entities
<input type="checkbox"/>	4 — Transmission-dependent Utilities
<input type="checkbox"/>	5 — Electric Generators
<input type="checkbox"/>	6 — Electricity Brokers, Aggregators, and Marketers
<input type="checkbox"/>	7 — Large Electricity End Users
<input type="checkbox"/>	8 — Small Electricity End Users
<input type="checkbox"/>	9 — Federal, State, and Provincial Regulatory or other Government Entities
<input type="checkbox"/>	10 — Regional Reliability Organizations and Regional Entities
<input type="checkbox"/>	NA – Not Applicable

**Select each Function<sup>1</sup> in which you have current or prior expertise:**

<input type="checkbox"/> Balancing Authority	<input type="checkbox"/> Transmission Operator
<input type="checkbox"/> Compliance Enforcement Authority	<input type="checkbox"/> Transmission Owner
<input type="checkbox"/> Distribution Provider	<input type="checkbox"/> Transmission Planner
<input type="checkbox"/> Generator Operator	<input type="checkbox"/> Transmission Service Provider
<input type="checkbox"/> Generator Owner	<input type="checkbox"/> Purchasing-selling Entity
<input type="checkbox"/> Interchange Authority	<input type="checkbox"/> Reliability Coordinator
<input type="checkbox"/> Load-serving Entity	<input type="checkbox"/> Reliability Assurer
<input type="checkbox"/> Market Operator	<input type="checkbox"/> Resource Planner
<input type="checkbox"/> Planning Coordinator	

**Provide the names and contact information for two references who could attest to your technical qualifications and your ability to work well in a group:**

Name:		Telephone:	
Organization:		E-mail:	
Name:		Telephone:	
Organization:		E-mail:	

<sup>1</sup> These functions are defined in the NERC [Functional Model](#), which is available on the NERC web site.



**Provide the name and contact information of your immediate supervisor or a member of your management who can confirm your organization's willingness to support your active participation.**

Name:		Telephone:	
Title:		Email:	

# Standards Announcement

## Project 2016-02 Modifications to CIP Standards

Supplemental Nomination Period Open through **March 23, 2016**

### [Now Available](#)

Nominations are being sought for additional standard drafting team (SDT) members through **8 p.m. Eastern, Wednesday, March 23, 2016**.

Use the [electronic form](#) to submit a nomination. If you experience any difficulties in using the electronic form, contact [Wendy Muller](#). An unofficial Word version of the nomination form is posted on the [Standard Drafting Team Vacancies](#) page and the [project page](#).

By submitting a nomination form, you are indicating your willingness and agreement to actively participate in face-to-face meetings and conference calls.

Previous drafting or review team experience is beneficial, but not required.

The time commitment for this project is expected to be significant. Participants should anticipate an average workload of 20 hours per week devoted to the SDT efforts. In person meetings will occur typically for 2 ½ - 3 days most months (not including travel time) and meetings will take place in different parts of North America. When not meeting in person, regularly scheduled conference calls will be used to conduct drafting team work. Outside the scheduled meetings, individuals or subgroups will have additional preparation and support work such as researching and developing proposed concepts, reviewing proposals, compiling comments and drafting responses, etc. Lastly, outreach is an important component of this SDT's effort. Members of the team are expected to interact with other stakeholders during the revision development process.

See the [project page](#) and unofficial nomination form for more information.

### Next Steps

The Standards Committee is expected to appoint members to the team in April 2016. Nominees will be notified shortly after they have been appointed.

For information on the Standards Development Process, refer to the [Standard Processes Manual](#).

For more information or assistance, contact either Senior Standards Developer, [Stephen Crutchfield](#) at (609) 651-9455 or [Al McMeekin](#) at (404) 446-9675.

North American Electric Reliability Corporation  
3353 Peachtree Rd, NE  
Suite 600, North Tower  
Atlanta, GA 30326

404-446-2560 | [www.nerc.com](http://www.nerc.com)

# Unofficial Nomination Form

## Project Number 2016-02 Modifications to CIP Standards

**Do not** use this form for submitting nominations. Use the [electronic form](#) to submit nominations by **8 p.m. Eastern, Wednesday, May 23, 2018**. This unofficial version is provided to assist nominees in compiling the information necessary to submit the electronic form.

Additional information can be found on the [Project 2016-02 Modifications to the CIP Standards](#) page. If you have questions, contact Standards Developer, [Jordan Mallory](#) (via email), or at 404-446-2589.

By submitting a nomination form, you are indicating your willingness and agreement to actively participate in face-to-face meetings and conference calls.

Previous drafting or review team experience is beneficial, but not required. A brief description of the desired qualifications, expected commitment, and other pertinent information is included below.

### **Project 2016-02 Modifications to CIP Standards**

This solicitation for nominations is to augment the existing Project 2016-02 Modifications to CIP Standards drafting team that is continuing to address the Standards Authorization Request. NERC is seeking individuals from the United States and Canada who possess experience in one or more of the following areas, but are not limited to:

- Virtualization;
- Cyber Asset and BES Cyber Asset Definitions; and
- Network and Externally Accessible Devices.

### **Standards Affected**

CIP-002-5.1, CIP-003-6, CIP-004-6, CIP-005-5, CIP-006-6, CIP-007-6, CIP-008-5, CIP-009-6, CIP-010-2, CIP-011-2, and CIP-012-1.

The time commitment for this project is expected to be up to two face-to-face meetings per quarter (on average two full working days each meeting) with conference calls scheduled as needed to meet the agreed-upon timeline the review or drafting team sets forth. Team members may also have side projects, either individually or by subgroup, to present to the larger team for discussion and review. Lastly, an important component of the review and drafting team effort is outreach. Members of the team will be expected to conduct industry outreach during the development process to support a successful project outcome.

<b>Name:</b>		
<b>Organization:</b>		
<b>Address:</b>		
<b>Telephone:</b>		
<b>E-mail:</b>		
<b>Please briefly describe your experience and qualifications to serve on the requested Standard Drafting Team (Bio):</b>		
<p><b>If you are currently a member of any NERC drafting team(s), please list each one here:</b></p> <input type="checkbox"/> Not currently on any active SAR or standard drafting team. <input type="checkbox"/> Currently a member of the following SAR or standard drafting team(s):		
<p><b>If you previously worked on any NERC drafting team(s), please identify each one here:</b></p> <input type="checkbox"/> No prior NERC SAR or standard drafting team. <input type="checkbox"/> Prior experience on the following team(s):		
<b>Select each NERC Region in which you have experience relevant to the Project for which you are volunteering:</b>		
<input type="checkbox"/> Texas RE <input type="checkbox"/> FRCC <input type="checkbox"/> MRO	<input type="checkbox"/> NPCC <input type="checkbox"/> RF <input type="checkbox"/> SERC	<input type="checkbox"/> SPP RE <input type="checkbox"/> WECC <input type="checkbox"/> NA – Not Applicable

Select each Industry Segment that you represent:	
<input type="checkbox"/>	1 — Transmission Owners
<input type="checkbox"/>	2 — RTOs, ISOs
<input type="checkbox"/>	3 — Load-serving Entities
<input type="checkbox"/>	4 — Transmission-dependent Utilities
<input type="checkbox"/>	5 — Electric Generators
<input type="checkbox"/>	6 — Electricity Brokers, Aggregators, and Marketers
<input type="checkbox"/>	7 — Large Electricity End Users
<input type="checkbox"/>	8 — Small Electricity End Users
<input type="checkbox"/>	9 — Federal, State, and Provincial Regulatory or other Government Entities
<input type="checkbox"/>	10 — Regional Reliability Organizations and Regional Entities
<input type="checkbox"/>	NA — Not Applicable
Select each Function <sup>1</sup> in which you have current or prior expertise:	
<input type="checkbox"/> Balancing Authority	<input type="checkbox"/> Transmission Operator
<input type="checkbox"/> Compliance Enforcement Authority	<input type="checkbox"/> Transmission Owner
<input type="checkbox"/> Distribution Provider	<input type="checkbox"/> Transmission Planner
<input type="checkbox"/> Generator Operator	<input type="checkbox"/> Transmission Service Provider
<input type="checkbox"/> Generator Owner	<input type="checkbox"/> Purchasing-selling Entity
<input type="checkbox"/> Interchange Authority	<input type="checkbox"/> Reliability Coordinator
<input type="checkbox"/> Load-serving Entity	<input type="checkbox"/> Reliability Assurer
<input type="checkbox"/> Market Operator	<input type="checkbox"/> Resource Planner
<input type="checkbox"/> Planning Coordinator	

<sup>1</sup> These functions are defined in the NERC [Functional Model](#), which is available on the NERC web site.

**Provide the names and contact information of two references who could attest to your technical qualifications and your ability to work well in a group:**

Name:		Telephone:	
Organization:		E-mail:	
Name:		Telephone:	
Organization:		E-mail:	

**Provide the name and contact information of your immediate supervisor or a member of your management who can confirm your organization's willingness to support your active participation.**

Name:		Telephone:	
Title:		Email:	

# Standards Announcement

## Project 2016-02 Modifications to CIP Standards

Nomination Period Open through May 23, 2018

### [Now Available](#)

Nominations are being sought for additional standard drafting team members through **8 p.m. Eastern, Wednesday, May 23, 2018**.

Use the [electronic form](#) to submit a nomination. If you experience difficulties using the electronic form, contact [Wendy Muller](#). An unofficial Word version of the nomination form is posted on the [Standard Drafting Team Vacancies](#) and the [project page](#).

By submitting a nomination form, you are indicating your willingness and agreement to actively participate in face-to-face meetings and conference calls.

The time commitment for this project is expected to be up to two face-to-face meetings per quarter (on average two full working days each meeting) with conference calls scheduled as needed to meet the agreed-upon timeline the review or drafting team sets forth. Team members may also have side projects, either individually or by subgroup, to present to the larger team for discussion and review. Lastly, an important component of the review and drafting team effort is outreach. Members of the team will be expected to conduct industry outreach during the development process to support a successful project outcome.

Previous drafting or review team experience is beneficial, but not required.

### **Project 2016-02 Modifications to CIP Standards**

This solicitation for nominations is to augment the existing Project 2016-02 Modifications to CIP Standards drafting team that is continuing to address the Standards Authorization Request. NERC is seeking individuals from the United States and Canada who possess experience in one or more of the following areas, but are not limited to:

- Virtualization;
- Cyber Asset and BES Cyber Asset Definitions; and
- Network and Externally Accessible Devices.

### **Standards Affected**

CIP-002-5.1, CIP-003-6, CIP-004-6, CIP-005-5, CIP-006-6, CIP-007-6, CIP-008-5, CIP-009-6, CIP-010-2, CIP-011-2, and CIP-012-1.



## Next Steps

The Standards Committee is expected to appoint members to the team in June 2018. Nominees will be notified shortly after they have been appointed.

For information on the Standards Development Process, refer to the [Standard Processes Manual](#).

For more information or assistance, contact [Mat Bunch](#) at (404) 446-9785 or [Jordan Mallory](#) at (404) 446-2589.

North American Electric Reliability Corporation  
3353 Peachtree Rd, NE  
Suite 600, North Tower  
Atlanta, GA 30326  
404-446-2560 | [www.nerc.com](http://www.nerc.com)

# Standard Authorization Request (SAR)

Complete and please email this form, with attachment(s) to: [sarcomm@nerc.net](mailto:sarcomm@nerc.net)

The North American Electric Reliability Corporation (NERC) welcomes suggestions to improve the reliability of the bulk power system through improved Reliability Standards.

Requested information	
SAR Title:	Critical Infrastructure Protection Reliability Standard CIP-003-7 – Cyber Security – Security Management Controls
Date Submitted:	April 24, 2018
SAR Requester	
Name:	Jordan Mallory
Organization:	NERC
Telephone:	404.446.2589
Email:	Jordan.mallory@nerc.net
SAR Type (Check as many as apply)	
<input type="checkbox"/> New Standard <input checked="" type="checkbox"/> Revision to Existing Standard <input type="checkbox"/> Add, Modify or Retire a Glossary Term <input type="checkbox"/> Withdraw/retire an Existing Standard	<input type="checkbox"/> Imminent Action/ Confidential Issue (SPM Section 10) <input type="checkbox"/> Variance development or revision <input type="checkbox"/> Other (Please specify)
Justification for this proposed standard development project (Check all that apply to help NERC prioritize development)	
<input checked="" type="checkbox"/> Regulatory Initiation <input type="checkbox"/> Emerging Risk (Reliability Issues Steering Committee) Identified <input type="checkbox"/> Reliability Standard Development Plan	<input type="checkbox"/> NERC Standing Committee Identified <input type="checkbox"/> Enhanced Periodic Review Initiated <input type="checkbox"/> Industry Stakeholder Identified
Industry Need (What Bulk Electric System (BES) reliability benefit does the proposed project provide?):	
On April 19, 2018, the Federal Regulatory Energy Commission (Commission) issued Order No. 843 approving CIP-003-7 and directing NERC to develop modifications to Reliability Standard CIP-003-7 to mitigate the risk of malicious code that could result from third-party transient electronic devices.	
Purpose or Goal (How does this proposed project provide the reliability-related benefit described above?):	
The purpose of this project is to address the Commission directive regarding third-party transient electronic devices contained in Order No. 843. These revisions will improve the security posture of responsible entities by clarifying compliance expectations.	
Project Scope (Define the parameters of the proposed project):	
The proposed project will address the Commission directive regarding third-party transient electronic devices in Order No. 843 through modifications to CIP-003-7 Reliability Standard. The work will include development of Violation Risk Factors, Violation Severity Levels, and an Implementation Plan for the modified standard.	

Requested information
Detailed Description (Describe the proposed deliverable(s) with sufficient detail for a drafting team to execute the project. If you propose a new or substantially revised Reliability Standard or definition, provide: (1) a technical justification <sup>1</sup> which includes a discussion of the reliability-related benefits of developing a new or revised Reliability Standard or definition, and (2) a technical foundation document (e.g. research paper) to guide development of the Standard or definition):
The SDT shall address the Order No. 843 directive by developing modifications to Reliability Standard CIP-003-7. The Commission directed the following:  <i>Per paragraph 37, “[The Commission] ...direct[s] that NERC develop modifications to Reliability Standard CIP-003-7 to address our concern and ensure that responsible entities implement controls to mitigate the risk of malicious code that could result from third-party transient electronic devices. NERC could satisfactorily address the identified concern, for example, by modifying Section 5 of Attachment 1 to CIP-003-7 to clarify that responsible entities must implement controls to mitigate the risk of malicious code that could result from the use of third-party transient electronic devices.”</i>
Cost Impact Assessment, if known (Provide a paragraph describing the potential cost impacts associated with the proposed project):
No additional cost outside of the time and resources needed to serve on the Standard Drafting Team are expected. However, a question will be asked during the SAR comment period to ensure all aspects are considered.
Please describe any unique characteristics of the BES facilities that may be impacted by this proposed standard development project (e.g. Dispersed Generation Resources):
None
To assist the NERC Standards Committee in appointing a drafting team with the appropriate members, please indicate to which Functional Entities the proposed standard(s) should apply (e.g. Transmission Operator, Reliability Coordinator, etc. See the most recent version of the NERC Functional Model for definitions):
Balancing Authority, certain Distribution Providers, Generator Owner, Generator Operator, Interchange Coordinator or Interchange Authority, Reliability Coordinator, Transmission Owner, Transmission Operator
Do you know of any consensus building activities <sup>2</sup> in connection with this SAR? If so, please provide any recommendations or findings resulting from the consensus building activity.
No consensus building has been completed to date.
Are there any related standards or SARs that should be assessed for impact as a result of this proposed project? If so which standard(s) or project number(s)?
Project 2016-02 is currently working on addressing CIP directives and the V5TAG Transition document.

<sup>1</sup> The NERC Rules of Procedure require a technical justification for new or substantially revised Reliability Standards. Please attach pertinent information to this form before submittal to NERC.

<sup>2</sup> Consensus building activities are occasionally conducted by NERC and/or project review teams. They typically are conducted to obtain industry inputs prior to proposing any standard development project to revise, or develop a standard or definition.

**Requested information**

Are there alternatives (e.g. guidelines, white paper, alerts, etc.) that have been considered or could meet the objectives? If so, please list the alternatives.

NA

**Reliability Principles**

Does this proposed standard development project support at least one of the following Reliability Principles ([Reliability Interface Principles](#))? Please check all those that apply.

<input type="checkbox"/>	1. Interconnected bulk power systems shall be planned and operated in a coordinated manner to perform reliably under normal and abnormal conditions as defined in the NERC Standards.
<input type="checkbox"/>	2. The frequency and voltage of interconnected bulk power systems shall be controlled within defined limits through the balancing of real and reactive power supply and demand.
<input type="checkbox"/>	3. Information necessary for the planning and operation of interconnected bulk power systems shall be made available to those entities responsible for planning and operating the systems reliably.
<input type="checkbox"/>	4. Plans for emergency operation and system restoration of interconnected bulk power systems shall be developed, coordinated, maintained and implemented.
<input type="checkbox"/>	5. Facilities for communication, monitoring and control shall be provided, used and maintained for the reliability of interconnected bulk power systems.
<input type="checkbox"/>	6. Personnel responsible for planning and operating interconnected bulk power systems shall be trained, qualified, and have the responsibility and authority to implement actions.
<input type="checkbox"/>	7. The security of the interconnected bulk power systems shall be assessed, monitored and maintained on a wide area basis.
<input checked="" type="checkbox"/>	8. Bulk power systems shall be protected from malicious physical or cyber attacks.

**Market Interface Principles**

Does the proposed standard development project comply with all of the following [Market Interface Principles](#)?

Enter (yes/no)

1. A reliability standard shall not give any market participant an unfair competitive advantage.	yes
2. A reliability standard shall neither mandate nor prohibit any specific market structure.	yes
3. A reliability standard shall not preclude market solutions to achieving compliance with that standard.	yes
4. A reliability standard shall not require the public disclosure of commercially sensitive information. All market participants shall have equal opportunity to access commercially non-sensitive information that is required for compliance with reliability standards.	yes

**Identified Existing or Potential Regional or Interconnection Variances**

Region(s)/ Interconnection	Explanation
e.g. NPCC	

## For Use by NERC Only

SAR Status Tracking (Check off as appropriate)	
<input checked="" type="checkbox"/> Draft SAR reviewed by NERC Staff <input type="checkbox"/> Draft SAR presented to SC for acceptance <input type="checkbox"/> DRAFT SAR approved for posting by the SC	<input type="checkbox"/> Final SAR endorsed by the SC <input type="checkbox"/> SAR assigned a Standards Project by NERC <input type="checkbox"/> SAR denied or proposed as Guidance document

### Version History

Version	Date	Owner	Change Tracking
1	June 3, 2013		Revised
1	August 29, 2014	Standards Information Staff	Updated template
2	January 18, 2017	Standards Information Staff	Revised
2	June 28, 2017	Standards Information Staff	Updated template

## Unofficial Comment Form

### Project 2016-02 Modifications to CIP Standards CIP-003-7 – Cyber Security – Security Management Controls Standards Authorization Request (SAR)

**Do not** use this form for submitting comments. Use the [Standards Balloting and Commenting System](#) to submit comments on the **Project 2016-02 Modifications to CIP Standards FERC Order No. 843 (Malicious Code Example) SAR**. Comments must be submitted by **8 p.m. Eastern, Friday, July 13, 2018**.

Additional information is available on the [project page](#). If you have questions, contact [Jordan Mallory](#) (via emails) or at 404-446-2589.

#### Background Information

On April 19, 2018, FERC issued Order No. 843 approving Reliability Standard CIP-003-7 (Cyber Security – Security Management Controls) and directing NERC to address the risk of malicious code that could result from third-party transient electronic devices through standard modifications. Specifically, FERC directed NERC to “develop modifications to Reliability Standard CIP-003-7 to address our concern and ensure that responsible entities implement controls to mitigate the risk of malicious code that could result from third-party transient electronic devices.” (Order No. 843 at P 37).

In addition, FERC provided an example of how the directive could be addressed: “NERC could satisfactorily address the identified concern, for example, by modifying Section 5 of Attachment 1 to CIP-003-7 to clarify that responsible entities must implement controls to mitigate the risk of malicious code that could result from the use of third-party transient electronic devices.” (Order No. 843 at P 37).

**Questions**

1. Do you agree with the scope and objectives of this SAR? If not, please explain why you do not agree, and, if possible, provide specific language revisions that would make it acceptable to you.

Yes:

No:

Comments:

2. Are you aware of any Canadian provincial or other regulatory requirements that may need to be considered during this project in order to develop a continent-wide approach to the standards? If yes, please identify the jurisdiction and specific regulatory requirements.

Yes:

No:

Comments:

3. Are there any other concerns with this SAR that haven't been covered in previous questions?

Yes:

No:

Comments:

# Standards Announcement

## 2016-02 Modifications to CIP Standards

Informal Comment Periods Open through July 13, 2018

### [Now Available](#)

Informal comment periods are open through **8 p.m. Eastern, Friday, July 13, 2018**, for stakeholders to provide feedback on the **FERC Order No. 843 (Malicious Code Example)** and **IROL Modifications to CIP-002 Standards Authorization Requests**.

### Commenting

Use the [Standards Balloting and Commenting System \(SBS\)](#) to submit comments. If you experience difficulty navigating the SBS, contact [Wendy Muller](#). An unofficial Word versions of the comment form is posted on the [project page](#).

- *If you are having difficulty accessing the SBS due to a forgotten password, incorrect credential error messages, or system lock-out, contact NERC IT support directly at <https://support.nerc.net/> (Monday – Friday, 8 a.m. - 5 p.m. Eastern).*
- *Passwords expire every **6 months** and must be reset.*
- *The SBS **is not** supported for use on mobile devices.*
- *Please be mindful of ballot and comment period closing dates. We ask to **allow at least 48 hours** for NERC support staff to assist with inquiries. Therefore, it is recommended that users try logging into their SBS accounts **prior to the last day** of a comment/ballot period.*

### Next Steps

The drafting team will review all responses received and determine the next steps of the project.

For more information on the Standards Development Process, refer to the [Standard Processes Manual](#).

For more information or assistance, contact Standards Developer, [Jordan Mallory](#) (via email) or at (404) 446-2589.

North American Electric Reliability Corporation  
3353 Peachtree Rd, NE  
Suite 600, North Tower  
Atlanta, GA 30326  
404-446-2560 | [www.nerc.com](http://www.nerc.com)



## Comment Report

**Project Name:** 2016-02 Modifications to CIP Standards | FERC Order No. 843 (Malicious Code Example) SAR  
Comment Period Start Date: 6/14/2018  
Comment Period End Date: 7/13/2018  
Associated Ballots:

There were 18 sets of responses, including comments from approximately 91 different people from approximately 68 companies representing 10 of the Industry Segments as shown in the table on the following pages.

## Questions

1. Do you agree with the scope and objectives of this SAR? If not, please explain why you do not agree, and, if possible, provide specific language revisions that would make it acceptable to you.
2. Are you aware of any Canadian provincial or other regulatory requirements that may need to be considered during this project in order to develop a continent-wide approach to the standards? If yes, please identify the jurisdiction and specific regulatory requirements.
3. Are there any other concerns with this SAR that haven't been covered in previous questions?

Organization Name	Name	Segment(s)	Region	Group Name	Group Member Name	Group Member Organization	Group Member Segment(s)	Group Member Region
FirstEnergy - FirstEnergy Corporation	Aaron Ghodooshim	1,3,4	RF	FirstEnergy Corporation	Aaron Ghodooshim	FirstEnergy - FirstEnergy Corporation	4	RF
					Aubrey Short	FirstEnergy - FirstEnergy Corporation	1	RF
					Theresa Ciancio	FirstEnergy - FirstEnergy Corporation	3	RF
					Robert Loy	FirstEnergy - FirstEnergy Solutions	5	RF
					Ann Ivanc	FirstEnergy - FirstEnergy Solutions	6	RF
Florida Municipal Power Agency	Brandon McCormick	3,4,5,6	FRCC	FMPA	Tim Beyrle	City of New Smyrna Beach Utilities Commission	4	FRCC
					Jim Howard	Lakeland Electric	5	FRCC
					Lynne Mila	City of Clewiston	4	FRCC
					Javier Cisneros	Fort Pierce Utilities Authority	3	FRCC
					Randy Hahn	Ocala Utility Services	3	FRCC
					Don Cuevas	Beaches Energy Services	1	FRCC
					Jeffrey Partington	Keys Energy Services	4	FRCC
					Tom Reedy	Florida Municipal Power Pool	6	FRCC
					Steven Lancaster	Beaches Energy Services	3	FRCC

					Mike Blough	Kissimmee Utility Authority	5	FRCC
					Chris Adkins	City of Leesburg	3	FRCC
					Ginny Beigel	City of Vero Beach	3	FRCC
MRO	Dana Klem	1,2,3,4,5,6	MRO	MRO NSRF	Joseph DePoorter	Madison Gas & Electric	3,4,5,6	MRO
					Larry Heckert	Alliant Energy	4	MRO
					Amy Casucelli	Xcel Energy	1,3,5,6	MRO
					Michael Brytowski	Great River Energy	1,3,5,6	MRO
					Jodi Jensen	Western Area Power Administration	1,6	MRO
					Kayleigh Wilkerson	Lincoln Electric System	1,3,5,6	MRO
					Mahmood Safi	Omaha Public Power District	1,3,5,6	MRO
					Brad Parret	Minnesota Power	1,5	MRO
					Terry Harbour	MidAmerican Energy Company	1,3	MRO
					Tom Breene	Wisconsin Public Service Corporation	3,5,6	MRO
					Jeremy Voll	Basin Electric Power Cooperative	1	MRO
					Kevin Lyons	Central Iowa Power Cooperative	1	MRO
					Mike Morrow	Midcontinent ISO	2	MRO
BC Hydro and Power Authority	Patricia Robertson	1,3,5		BC Hydro	Patricia Robertson	BC Hydro and Power Authority	1	WECC
					Venkataramakrishnan Vinnakota	BC Hydro and Power Authority	2	WECC

					Pat G. Harrington	BC Hydro and Power Authority	3	WECC
					Clement Ma	BC Hydro and Power Authority	5	WECC
Northeast Power Coordinating Council	Ruida Shu	1,2,3,4,5,6,7,8,9,10	NPCC	RSC no Dominion	Guy V. Zito	Northeast Power Coordinating Council	10	NPCC
					Randy MacDonald	New Brunswick Power	2	NPCC
					Wayne Sipperly	New York Power Authority	4	NPCC
					Glen Smith	Entergy Services	4	NPCC
					Brian Robinson	Utility Services	5	NPCC
					Alan Adamson	New York State Reliability Council	7	NPCC
					Edward Bedder	Orange & Rockland Utilities	1	NPCC
					David Burke	Orange & Rockland Utilities	3	NPCC
					Michele Tondalo	UI	1	NPCC
					Laura Mcleod	NB Power	1	NPCC
					David Ramkalawan	Ontario Power Generation Inc.	5	NPCC
					Helen Lainis	IESO	2	NPCC
					Michael Schiavone	National Grid	1	NPCC
					Michael Jones	National Grid	3	NPCC
					Michael Forte	Con Ed - Consolidated Edison	1	NPCC
					Peter Yost	Con Ed - Consolidated	3	NPCC

					Edison Co. of New York			
					Sean Cavote	PSEG	4	NPCC
					Kathleen Goodman	ISO-NE	2	NPCC
					Quintin Lee	Eversource Energy	1	NPCC
					Dermot Smyth	Con Ed - Consolidated Edison Co. of New York	1,5	NPCC
					Dermot Smyth	Con Ed - Consolidated Edison Co. of New York	1,5	NPCC
					Salvatore Spagnolo	New York Power Authority	1	NPCC
					Shivaz Chopra	New York Power Authority	6	NPCC
					David Kiguel	Independent	NA - Not Applicable	NPCC
					Silvia Mitchell	NextEra Energy - Florida Power and Light Co.	6	NPCC
					Caroline Dupuis	Hydro Quebec	1	NPCC
					Chantal Mazza	Hydro Quebec	2	NPCC
					Gregory Campoli	New York Independent System Operator	2	NPCC
					Paul Malozewski	Hydro One Networks, Inc.	3	NPCC
PSEG	Sean Cavote	1,3,5,6	NPCC,RF	PSEG REs	Tim Kucey	PSEG - PSEG Fossil LLC	5	NPCC
					Karla Barton	PSEG - PSEG Energy Resources and Trade LLC	6	RF
					Jeffrey Mueller	PSEG - Public Service Electric and Gas Co.	3	RF

					Joseph Smith	PSEG - Public Service Electric and Gas Co.	1	RF
Southwest Power Pool, Inc. (RTO)	Shannon Mickens	2	MRO,SPP RE	SPP Standards Review Group	Shannon Mickens	Southwest Power Pool Inc.	2	MRO
					Jim Williams	Southwest Power Pool Inc	2	MRO
					John Allen	City Utilities of Springfield, Missouri	4	MRO
					Louis Guidry	Cleco	1,3,5,6	SERC
					Matt Harward	Southwest Power Pool Inc	2	MRO
					Steven Keller	Southwest Power Pool Inc.	2	MRO
					Alan Wahlstrom	Southwest Power Pool Inc	2	MRO
					Kim Van Brimer	Southwest Power Pool Inc	2	MRO

1. Do you agree with the scope and objectives of this SAR? If not, please explain why you do not agree, and, if possible, provide specific language revisions that would make it acceptable to you.

Thomas Foltz - AEP - 3,5

Answer No

Document Name

Comment

AEP is concerned by the inclusion of the phrase “transient electronic devices”, as that would imply a scope broader than that of other CIP standards. In fact, it essentially creates an entirely new category of devices. Rather than this language, AEP suggests instead using the NERC defined terms Transient Cyber Assets and Removable Media as the obligations are further qualified.

It appears that these two proposed SARs would be applied to the project along with the existing SAR, bringing the total number of SARs for this project to three. AEP is not aware of any precedent of multiple, **concurrent** SARs governing a NERC project at a single point in time. A SAR helps set a project’s direction and scope, and while a project’s SAR may be revised over time, AEP does not believe Appendix 3A (Standards Process Manual) provides an allowance for multiple, concurrent SARs to govern a single NERC project. Rather, the SPM allows a project’s existing SAR to be revised to accommodate any changes believed to be necessary.

Likes 0

Dislikes 0

Response

Marty Hostler - Northern California Power Agency - 5,6

Answer No

Document Name

Comment

NCPA is concerned by the inclusion of the phrase “transient electronic devices”, as that would imply a scope broader than that of other CIP standards. In fact, it essentially creates an entirely new category of devices. Rather than this language, the NERC defined terms Transient Cyber Assets and Removable Media should be used.

Likes 0

Dislikes 0

Response

Dennis Sismaet - Northern California Power Agency - 5,6

Answer No



<b>Document Name</b>	
<b>Comment</b>	
NCPA is concerned by the inclusion of the phrase “transient electronic devices”, as that would imply a scope broader than that of other CIP standards. In fact, it essentially creates an entirely new category of devices. Rather than this language, the NERC defined terms Transient Cyber Assets and Removable Media should be used.	
Likes	0
Dislikes	0
<b>Response</b>	
<b>Wendy Center - U.S. Bureau of Reclamation - 1,5</b>	
<b>Answer</b>	No
<b>Document Name</b>	
<b>Comment</b>	
Reclamation recommends incorporating all requirements for low impact BCS into existing standards in the table and part format. For example, low impact malicious code requirements would properly be added to CIP-007; low impact transient cyber asset requirements would properly be added to CIP-010	
Likes	0
Dislikes	0
<b>Response</b>	
<b>Patricia Robertson - BC Hydro and Power Authority - 1,3,5, Group Name BC Hydro</b>	
<b>Answer</b>	No
<b>Document Name</b>	
<b>Comment</b>	
<p>Upon review of the proposed SAR, BC Hydro offers the following comments in support of the position that this SAR needs to be more specific.</p> <p>1. As the existing version of CIP-003-7 already specifies in its Section 5 of Attachment 1 mandatory prescriptions to implement “one or more plan(s) to achieve the objective of mitigating the risk of the introduction of malicious code” including third-party transient electronic devices (i.e. “Transient Cyber Asset(s) managed by a party other than the Responsible Entity” per Section 5.2), BC Hydro does not share FERC’s concern and recommends that the SAR provide more clarity on the scope and reasoning behind FERC’s requested modifications, i.e. “to include an explicit requirement that responsible entities implement controls to mitigate the risk of malicious code that could result from third-party transient electronic devices”. (P 39 on Page 24 of <a href="#">FERC Order No. 843</a>)</p>	

2. BC Hydro would like to understand the value add of revising CIP-003-7 when very similar language is already there. BC Hydro notes that Requirement 4 of the CIP-010-2(3) reliability standard in regards to high and medium impact BES Cyber Systems, Attachment 1, Section 2 and sub-Section 2.2 also contains very similar language and is not being revised.

Likes 0

Dislikes 0

### Response

#### Russell Martin II - Salt River Project - 1,3,5,6 - WECC

Answer

Yes

Document Name

Comment

SRP understands the main objective of the SAR is to clarify compliance expectations regarding third-party transient electronic devices. SRP also agrees with the scope of modifying CIP-003-7, Attachment 1, Section 5.

Likes 0

Dislikes 0

### Response

#### Dana Klem - MRO - 1,2,3,4,5,6 - MRO, Group Name MRO NSRF

Answer

Yes

Document Name

Comment

The NSRF agrees with the scope of the SAR addressing FERC's directive by modifying Section 5 of Attachment 1 to CIP-003-7 to clarify that responsible entities must implement controls to mitigate the risk of malicious code that could result from the use of third-party transient electronic devices

Likes 0

Dislikes 0

### Response

#### Aaron Cavanaugh - Bonneville Power Administration - 1,3,5,6 - WECC

Answer

Yes

Document Name

Comment

None

Likes 0

Dislikes 0

**Response**

**Sean Cavote - PSEG - 1,3,5,6 - NPCC,RF, Group Name PSEG REs**

**Answer**

Yes

**Document Name**

**Comment**

PSEG supports the proposed CIP-003-7 SAR because it provides sufficient scope and direction for the SDT to address the FERC Order No. 843 directive regarding third-party transient electronic devices.

Likes 0

Dislikes 0

**Response**

**Aaron Ghodooshim - FirstEnergy - FirstEnergy Corporation - 1,3,4, Group Name FirstEnergy Corporation**

**Answer**

Yes

**Document Name**

**Comment**

Likes 0

Dislikes 0

**Response**

**David Ramkalawan - Ontario Power Generation Inc. - 5**

**Answer**

Yes

**Document Name**

**Comment**

Likes 0

Dislikes 0

**Response**

**David Jendras - Ameren - Ameren Services - 1,3,6**

**Answer**

Yes

**Document Name**

**Comment**

Likes 0

Dislikes 0

**Response**

**Andrew Gallo - Austin Energy - 1,3,4,5,6**

**Answer**

Yes

**Document Name**

**Comment**

Likes 0

Dislikes 0

**Response**

**Vivian Vo - APS - Arizona Public Service Co. - 1,3,5,6**

**Answer**

Yes

**Document Name**

**Comment**

Likes 0

Dislikes 0

**Response**

**Brandon McCormick - Florida Municipal Power Agency - 3,4,5,6 - FRCC, Group Name FMPA**

**Answer**

Yes

<b>Document Name</b>	
<b>Comment</b>	
Likes 0	
Dislikes 0	
<b>Response</b>	
<b>Warren Cross - ACES Power Marketing - 2,4,5,6 - WECC,Texas RE,SERC,RF</b>	
<b>Answer</b>	Yes
<b>Document Name</b>	
<b>Comment</b>	
Likes 0	
Dislikes 0	
<b>Response</b>	
<b>Shannon Mickens - Southwest Power Pool, Inc. (RTO) - 2 - MRO, Group Name SPP Standards Review Group</b>	
<b>Answer</b>	Yes
<b>Document Name</b>	
<b>Comment</b>	
Likes 0	
Dislikes 0	
<b>Response</b>	
<b>Ruida Shu - Northeast Power Coordinating Council - 1,2,3,4,5,6,7,8,9,10 - NPCC, Group Name RSC no Dominion</b>	
<b>Answer</b>	Yes
<b>Document Name</b>	
<b>Comment</b>	
Likes 0	
Dislikes 0	

**Response**

2. Are you aware of any Canadian provincial or other regulatory requirements that may need to be considered during this project in order to develop a continent-wide approach to the standards? If yes, please identify the jurisdiction and specific regulatory requirements.

Patricia Robertson - BC Hydro and Power Authority - 1,3,5, Group Name BC Hydro

Answer No

Document Name

Comment

At this time, this may change as the full scope of the SAR is developed.

Likes 0

Dislikes 0

Response

Brandon McCormick - Florida Municipal Power Agency - 3,4,5,6 - FRCC, Group Name FMPA

Answer No

Document Name

Comment

None that we are aware of.

Likes 0

Dislikes 0

Response

Aaron Cavanaugh - Bonneville Power Administration - 1,3,5,6 - WECC

Answer No

Document Name

Comment

None

Likes 0

Dislikes 0

Response

**Ruida Shu - Northeast Power Coordinating Council - 1,2,3,4,5,6,7,8,9,10 - NPCC, Group Name RSC no Dominion**

**Answer** No

**Document Name**

**Comment**

Likes 0

Dislikes 0

**Response**

**Shannon Mickens - Southwest Power Pool, Inc. (RTO) - 2 - MRO, Group Name SPP Standards Review Group**

**Answer** No

**Document Name**

**Comment**

Likes 0

Dislikes 0

**Response**

**Warren Cross - ACES Power Marketing - 2,4,5,6 - WECC,Texas RE,SERC,RF**

**Answer** No

**Document Name**

**Comment**

Likes 0

Dislikes 0

**Response**

**Sean Cavote - PSEG - 1,3,5,6 - NPCC,RF, Group Name PSEG REs**

**Answer** No

**Document Name**

**Comment**



Likes 0

Dislikes 0

**Response**

**Vivian Vo - APS - Arizona Public Service Co. - 1,3,5,6**

**Answer** No

**Document Name**

**Comment**

Likes 0

Dislikes 0

**Response**

**Dana Klem - MRO - 1,2,3,4,5,6 - MRO, Group Name MRO NSRF**

**Answer** No

**Document Name**

**Comment**

Likes 0

Dislikes 0

**Response**

**Andrew Gallo - Austin Energy - 1,3,4,5,6**

**Answer** No

**Document Name**

**Comment**

Likes 0

Dislikes 0

**Response**

**David Jendras - Ameren - Ameren Services - 1,3,6**

Answer	No
Document Name	
Comment	
Likes 0	
Dislikes 0	
Response	
David Ramkalawan - Ontario Power Generation Inc. - 5	
Answer	No
Document Name	
Comment	
Likes 0	
Dislikes 0	
Response	
Aaron Ghodooshim - FirstEnergy - FirstEnergy Corporation - 1,3,4, Group Name FirstEnergy Corporation	
Answer	No
Document Name	
Comment	
Likes 0	
Dislikes 0	
Response	
Wendy Center - U.S. Bureau of Reclamation - 1,5	
Answer	No
Document Name	
Comment	
Likes 0	

Dislikes 0

**Response**

**Dennis Sismaet - Northern California Power Agency - 5,6**

**Answer** No

**Document Name**

**Comment**

Likes 0

Dislikes 0

**Response**

**Marty Hostler - Northern California Power Agency - 5,6**

**Answer** No

**Document Name**

**Comment**

Likes 0

Dislikes 0

**Response**

**Thomas Foltz - AEP - 3,5**

**Answer** No

**Document Name**

**Comment**

Likes 0

Dislikes 0

**Response**

**Russell Martin II - Salt River Project - 1,3,5,6 - WECC**

**Answer** No

<b>Document Name</b>	
<b>Comment</b>	
Likes 0	
Dislikes 0	
<b>Response</b>	

**3. Are there any other concerns with this SAR that haven't been covered in previous questions?**

**Wendy Center - U.S. Bureau of Reclamation - 1,5**

**Answer** No

**Document Name**

**Comment**

Likes 0

Dislikes 0

**Response**

**Aaron Cavanaugh - Bonneville Power Administration - 1,3,5,6 - WECC**

**Answer** No

**Document Name**

**Comment**

None

Likes 0

Dislikes 0

**Response**

**Thomas Foltz - AEP - 3,5**

**Answer** No

**Document Name**

**Comment**

Likes 0

Dislikes 0

**Response**

**Marty Hostler - Northern California Power Agency - 5,6**

Answer	No
Document Name	
Comment	
Likes 0	
Dislikes 0	
Response	
Dennis Sismaet - Northern California Power Agency - 5,6	
Answer	No
Document Name	
Comment	
Likes 0	
Dislikes 0	
Response	
Aaron Ghodooshim - FirstEnergy - FirstEnergy Corporation - 1,3,4, Group Name FirstEnergy Corporation	
Answer	No
Document Name	
Comment	
Likes 0	
Dislikes 0	
Response	
David Ramkalawan - Ontario Power Generation Inc. - 5	
Answer	No
Document Name	
Comment	
Likes 0	

Dislikes 0

**Response**

**David Jendras - Ameren - Ameren Services - 1,3,6**

**Answer**

No

**Document Name**

**Comment**

Likes 0

Dislikes 0

**Response**

**Andrew Gallo - Austin Energy - 1,3,4,5,6**

**Answer**

No

**Document Name**

**Comment**

Likes 0

Dislikes 0

**Response**

**Dana Klem - MRO - 1,2,3,4,5,6 - MRO, Group Name MRO NSRF**

**Answer**

No

**Document Name**

**Comment**

Likes 0

Dislikes 0

**Response**

**Vivian Vo - APS - Arizona Public Service Co. - 1,3,5,6**

**Answer**

No

<b>Document Name</b>	
<b>Comment</b>	
Likes 0	
Dislikes 0	
<b>Response</b>	
<b>Sean Cavote - PSEG - 1,3,5,6 - NPCC,RF, Group Name PSEG REs</b>	
<b>Answer</b>	No
<b>Document Name</b>	
<b>Comment</b>	
Likes 0	
Dislikes 0	
<b>Response</b>	
<b>Ruida Shu - Northeast Power Coordinating Council - 1,2,3,4,5,6,7,8,9,10 - NPCC, Group Name RSC no Dominion</b>	
<b>Answer</b>	No
<b>Document Name</b>	
<b>Comment</b>	
Likes 0	
Dislikes 0	
<b>Response</b>	
<b>Russell Martin II - Salt River Project - 1,3,5,6 - WECC</b>	
<b>Answer</b>	Yes
<b>Document Name</b>	
<b>Comment</b>	
<p>FERC Order 843, paragraph 34 states, "should a Responsible Entity find that a third party's processes and practices for protecting its transient electronic devices inadequate, the Responsible Entity must be required to take mitigating action prior to connecting third-party transient electronic devices to a low impact BES Cyber System." According to NERC, "failure to take mitigating action in this circumstance could result in a finding of</p>	



noncompliance with Section 5 of Attachment 1.” However, the SAR does not specify this to be the reasoning for the modification. The SAR should be revised to include this reasoning to better understand the intent behind the requested modification.

Likes 0

Dislikes 0

### Response

**Brandon McCormick - Florida Municipal Power Agency - 3,4,5,6 - FRCC, Group Name** FMPA

**Answer**

Yes

**Document Name**

**Comment**

The purpose of the SAR is to address FERC Order No. 843 which uses the phrase “third-party transient electronic devices.” We would strongly urge the SDT to not use this phrase when modifying CIP-003-7 but instead use the NERC glossary defined term “Transient Cyber Asset”. It is our opinion that using the NERC defined term of Transient Cyber Asset will allow the SDT to satisfy the requirements of the FERC order without creating an entirely new and unbounded class of assets.

Likes 0

Dislikes 0

### Response

**Shannon Mickens - Southwest Power Pool, Inc. (RTO) - 2 - MRO, Group Name** SPP Standards Review Group

**Answer**

Yes

**Document Name**

**Comment**

The SPP Standards Review Group (“SSRG”) understands the FERC order requires NERC address the narrowly defined issue related to risk of malicious code that could result from third-party transient electronic devices. Given the potential for other gaps within CIP-003-7 that relate to the mitigation of malicious code, the SSRG suggests the Standard Drafting Team consider utilizing this SAR to review the overarching issue of mitigating malicious code and explore whether additional changes are also appropriate to be included in proposed revisions to the standard.

Also, the Standards Drafting Team understands that changes to Section 5 of Attachment 1, as directed by FERC, will apply to Low Impact BES Cyber System Assets, which are by definition low risk. The Standards Drafting Team should ensure that the changes proposed to Section 5 of Attachment 1 do not inadvertently pull in other classifications of BES Cyber System Assets.

Finally, the SSRG recommends that Implementation Guidance should be developed.

Likes 0

Dislikes 0

### Response

**Warren Cross - ACES Power Marketing - 2,4,5,6 - WECC,Texas RE,SERC,RF**

**Answer** Yes

**Document Name**

**Comment**

Likes 0

Dislikes 0

**Response**

## Standard Development Timeline

This section is maintained by the drafting team during the development of the standard and will be removed when the standard is adopted by the NERC Board of Trustees (Board).

### Description of Current Draft

45-day initial formal comment period with ballot.

Completed Actions	Date
Standards Committee approved Standard Authorization Request (SAR) for posting	June 13, 2018
SAR posted for comment	June 13 – July 13, 2018

Anticipated Actions	Date
45-day formal comment period with ballot (initial)	August 23 – October 8, 2018
10-day final ballot	October 29 – November 8, 2018
Board adoption	February 2019

## A. Introduction

1. **Title:** Cyber Security — Security Management Controls
2. **Number:** CIP-003-8
3. **Purpose:** To specify consistent and sustainable security management controls that establish responsibility and accountability to protect BES Cyber Systems against compromise that could lead to misoperation or instability in the Bulk Electric System (BES).

### 4. Applicability:

**4.1. Functional Entities:** For the purpose of the requirements contained herein, the following list of functional entities will be collectively referred to as “Responsible Entities.” For requirements in this standard where a specific functional entity or subset of functional entities are the applicable entity or entities, the functional entity or entities are specified explicitly.

#### 4.1.1. Balancing Authority

**4.1.2. Distribution Provider** that owns one or more of the following Facilities, systems, and equipment for the protection or restoration of the BES:

**4.1.2.1.** Each underfrequency Load shedding (UFLS) or undervoltage Load shedding (UVLS) system that:

**4.1.2.1.1.** is part of a Load shedding program that is subject to one or more requirements in a NERC or Regional Reliability Standard; and

**4.1.2.1.2.** performs automatic Load shedding under a common control system owned by the Responsible Entity, without human operator initiation, of 300 MW or more.

**4.1.2.2.** Each Remedial Action Scheme (RAS) where the RAS is subject to one or more requirements in a NERC or Regional Reliability Standard.

**4.1.2.3.** Each Protection System (excluding UFLS and UVLS) that applies to Transmission where the Protection System is subject to one or more requirements in a NERC or Regional Reliability Standard.

**4.1.2.4.** Each Cranking Path and group of Elements meeting the initial switching requirements from a Blackstart Resource up to and including the first interconnection point of the starting station service of the next generation unit(s) to be started.

#### 4.1.3. Generator Operator

#### 4.1.4. Generator Owner

#### 4.1.5. Reliability Coordinator

#### 4.1.6. Transmission Operator

**4.1.7. Transmission Owner**

**4.2. Facilities:** For the purpose of the requirements contained herein, the following Facilities, systems, and equipment owned by each Responsible Entity in Section 4.1 above are those to which these requirements are applicable. For requirements in this standard where a specific type of Facilities, system, or equipment or subset of Facilities, systems, and equipment are applicable, these are specified explicitly.

**4.2.1. Distribution Provider:** One or more of the following Facilities, systems and equipment owned by the Distribution Provider for the protection or restoration of the BES:

**4.2.1.1.** Each UFLS or UVLS System that:

**4.2.1.1.1.** is part of a Load shedding program that is subject to one or more requirements in a NERC or Regional Reliability Standard; and

**4.2.1.1.2.** performs automatic Load shedding under a common control system owned by the Responsible Entity, without human operator initiation, of 300 MW or more.

**4.2.1.2.** Each RAS where the RAS is subject to one or more requirements in a NERC or Regional Reliability Standard.

**4.2.1.3.** Each Protection System (excluding UFLS and UVLS) that applies to Transmission where the Protection System is subject to one or more requirements in a NERC or Regional Reliability Standard.

**4.2.1.4.** Each Cranking Path and group of Elements meeting the initial switching requirements from a Blackstart Resource up to and including the first interconnection point of the starting station service of the next generation unit(s) to be started.

**4.2.2. Responsible Entities listed in 4.1 other than Distribution Providers:**

All BES Facilities.

**4.2.3. Exemptions:** The following are exempt from Standard CIP-003-8:

**4.2.3.1.** Cyber Assets at Facilities regulated by the Canadian Nuclear Safety Commission.

**4.2.3.2.** Cyber Assets associated with communication networks and data communication links between discrete Electronic Security Perimeters (ESPs).

**4.2.3.3.** The systems, structures, and components that are regulated by the Nuclear Regulatory Commission under a cyber security plan pursuant to 10 C.F.R. Section 73.54.

**4.2.3.4.** For Distribution Providers, the systems and equipment that are not included in section 4.2.1 above.

## 5. Effective Dates:

See Implementation Plan for CIP-003-8.

**5.1. Planned and Unplanned Changes:** For any Planned Change or Unplanned Change, as those terms are defined in the Effective Dates Section of Reliability Standard CIP-002, the Responsible Entity must comply with the requirements in this Reliability Standard on the date the Responsible Entity must comply with the requirements in Reliability Standard CIP-002 following a Planned Change or Unplanned Change.

## 6. Background:

Standard CIP-003 exists as part of a suite of CIP Standards related to cyber security, which require the initial identification and categorization of BES Cyber Systems and require organizational, operational, and procedural controls to mitigate risk to BES Cyber Systems.

The term policy refers to one or a collection of written documents that are used to communicate the Responsible Entities' management goals, objectives and expectations for how the Responsible Entity will protect its BES Cyber Systems. The use of policies also establishes an overall governance foundation for creating a culture of security and compliance with laws, regulations, and standards.

The term documented processes refers to a set of required instructions specific to the Responsible Entity and to achieve a specific outcome. This term does not imply any naming or approval structure beyond what is stated in the requirements. An entity should include as much as it believes necessary in its documented processes, but it must address the applicable requirements.

The terms program and plan are sometimes used in place of documented processes where it makes sense and is commonly understood. For example, documented processes describing a response are typically referred to as plans (i.e., incident response plans and recovery plans). Likewise, a security plan can describe an approach involving multiple procedures to address a broad subject matter.

Similarly, the term program may refer to the organization's overall implementation of its policies, plans, and procedures involving a subject matter. Examples in the standards include the personnel risk assessment program and the personnel training program. The full implementation of the CIP Cyber Security Reliability Standards could also be referred to as a program. However, the terms program and plan do not imply any additional requirements beyond what is stated in the standards.

Responsible Entities can implement common controls that meet requirements for multiple high, medium, and low impact BES Cyber Systems. For example, a single cyber security awareness program could meet the requirements across multiple BES Cyber Systems.

Measures provide examples of evidence to show documentation and implementation of the requirement. These measures serve to provide guidance to entities in acceptable records of compliance and should not be viewed as an all-inclusive list.

Throughout the standards, unless otherwise stated, bulleted items in the requirements and measures are items that are linked with an “or,” and numbered items are items that are linked with an “and.”

Many references in the Applicability section use a threshold of 300 MW for UFLS and UVLS. This particular threshold of 300 MW for UVLS and UFLS was provided in Version 1 of the CIP Cyber Security Standards. The threshold remains at 300 MW since it is specifically addressing UVLS and UFLS, which are last ditch efforts to save the BES. A review of UFLS tolerances defined within Regional Reliability Standards for UFLS program requirements to date indicates that the historical value of 300 MW represents an adequate and reasonable threshold value for allowable UFLS operational tolerances.

## B. Requirements and Measures

- R1.** Each Responsible Entity shall review and obtain CIP Senior Manager approval at least once every 15 calendar months for one or more documented cyber security policies that collectively address the following topics: *[Violation Risk Factor: Medium] [Time Horizon: Operations Planning]*
- 1.1.** For its high impact and medium impact BES Cyber Systems, if any:
    - 1.1.1.** Personnel and training (CIP-004);
    - 1.1.2.** Electronic Security Perimeters (CIP-005) including Interactive Remote Access;
    - 1.1.3.** Physical security of BES Cyber Systems (CIP-006);
    - 1.1.4.** System security management (CIP-007);
    - 1.1.5.** Incident reporting and response planning (CIP-008);
    - 1.1.6.** Recovery plans for BES Cyber Systems (CIP-009);
    - 1.1.7.** Configuration change management and vulnerability assessments (CIP-010);
    - 1.1.8.** Information protection (CIP-011); and
    - 1.1.9.** Declaring and responding to CIP Exceptional Circumstances.
  - 1.2.** For its assets identified in CIP-002 containing low impact BES Cyber Systems, if any:
    - 1.2.1.** Cyber security awareness;
    - 1.2.2.** Physical security controls;
    - 1.2.3.** Electronic access controls;
    - 1.2.4.** Cyber Security Incident response;
    - 1.2.5.** Transient Cyber Assets and Removable Media malicious code risk mitigation; and
    - 1.2.6.** Declaring and responding to CIP Exceptional Circumstances.
- M1.** Examples of evidence may include, but are not limited to, policy documents; revision history, records of review, or workflow evidence from a document management system that indicate review of each cyber security policy at least once every 15 calendar months; and documented approval by the CIP Senior Manager for each cyber security policy.
- R2.** Each Responsible Entity with at least one asset identified in CIP-002 containing low impact BES Cyber Systems shall implement one or more documented cyber security plan(s) for its low impact BES Cyber Systems that include the sections in Attachment 1. *[Violation Risk Factor: Lower] [Time Horizon: Operations Planning]*



Note: An inventory, list, or discrete identification of low impact BES Cyber Systems or their BES Cyber Assets is not required. Lists of authorized users are not required.

- M2.** Evidence shall include each of the documented cyber security plan(s) that collectively include each of the sections in Attachment 1 and additional evidence to demonstrate implementation of the cyber security plan(s). Additional examples of evidence per section are located in Attachment 2.
- R3.** Each Responsible Entity shall identify a CIP Senior Manager by name and document any change within 30 calendar days of the change. *[Violation Risk Factor: Medium]*  
*[Time Horizon: Operations Planning]*
- M3.** An example of evidence may include, but is not limited to, a dated and approved document from a high level official designating the name of the individual identified as the CIP Senior Manager.
- R4.** The Responsible Entity shall implement a documented process to delegate authority, unless no delegations are used. Where allowed by the CIP Standards, the CIP Senior Manager may delegate authority for specific actions to a delegate or delegates. These delegations shall be documented, including the name or title of the delegate, the specific actions delegated, and the date of the delegation; approved by the CIP Senior Manager; and updated within 30 days of any change to the delegation. Delegation changes do not need to be reinstated with a change to the delegator. *[Violation Risk Factor: Lower]* *[Time Horizon: Operations Planning]*
- M4.** An example of evidence may include, but is not limited to, a dated document, approved by the CIP Senior Manager, listing individuals (by name or title) who are delegated the authority to approve or authorize specifically identified items.

## C. Compliance

### 1. Compliance Monitoring Process

#### 1.1. Compliance Enforcement Authority:

As defined in the NERC Rules of Procedure, “Compliance Enforcement Authority” (CEA) means NERC or the Regional Entity in their respective roles of monitoring and enforcing compliance with the NERC Reliability Standards.

#### 1.2. Evidence Retention:

The following evidence retention periods identify the period of time an entity is required to retain specific evidence to demonstrate compliance. For instances where the evidence retention period specified below is shorter than the time since the last audit, the CEA may ask an entity to provide other evidence to show that it was compliant for the full time period since the last audit.

The Responsible Entity shall keep data or evidence to show compliance as identified below unless directed by its CEA to retain specific evidence for a longer period of time as part of an investigation:

- Each Responsible Entity shall retain evidence of each requirement in this standard for three calendar years.
- If a Responsible Entity is found non-compliant, it shall keep information related to the non-compliance until mitigation is complete and approved or for the time specified above, whichever is longer.
- The CEA shall keep the last audit records and all requested and submitted subsequent audit records.

#### 1.3. Compliance Monitoring and Assessment Processes:

- Compliance Audits
- Self-Certifications
- Spot Checking
- Compliance Investigations
- Self-Reporting
- Complaints

#### 1.4. Additional Compliance Information:

None.

### Violation Severity Levels

R #	Time Horizon	VRF	Violation Severity Levels (CIP-003-8)			
			Lower VSL	Moderate VSL	High VSL	Severe VSL
<b>R1</b>	<b>Operations Planning</b>	<b>Medium</b>	<p>The Responsible Entity documented and implemented one or more cyber security policies for its high impact and medium impact BES Cyber Systems, but did not address one of the nine topics required by R1. (R1.1)</p> <p>OR</p> <p>The Responsible Entity did not complete its review of the one or more documented cyber security policies for its high impact and medium impact BES Cyber Systems as required by R1 within 15 calendar months but did</p>	<p>The Responsible Entity documented and implemented one or more cyber security policies for its high impact and medium impact BES Cyber Systems, but did not address two of the nine topics required by R1. (R1.1)</p> <p>OR</p> <p>The Responsible Entity did not complete its review of the one or more documented cyber security policies for its high impact and medium impact BES Cyber Systems as required by R1 within 16 calendar months but did</p>	<p>The Responsible Entity documented and implemented one or more cyber security policies for its high impact and medium impact BES Cyber Systems, but did not address three of the nine topics required by R1. (R1.1)</p> <p>OR</p> <p>The Responsible Entity did not complete its review of the one or more documented cyber security policies for its high impact and medium impact BES Cyber Systems as required by R1 within 17 calendar months but did complete this review in less than or equal to 18</p>	<p>The Responsible Entity documented and implemented one or more cyber security policies for its high impact and medium impact BES Cyber Systems, but did not address four or more of the nine topics required by R1. (R1.1)</p> <p>OR</p> <p>The Responsible Entity did not have any documented cyber security policies for its high impact and medium impact BES Cyber Systems as required by R1. (R1.1)</p> <p>OR</p> <p>The Responsible Entity did not</p>

R #	Time Horizon	VRF	Violation Severity Levels (CIP-003-8)			
			Lower VSL	Moderate VSL	High VSL	Severe VSL
			complete this review in less than or equal to 16 calendar months of the previous review. (R1.1) OR The Responsible Entity did not complete its approval of the one or more documented cyber security policies for its high impact and medium impact BES Cyber Systems as required by R1 by the CIP Senior Manager within 15 calendar months but did complete this approval in less than or equal to 16 calendar months of the previous approval. (R1.1)	complete this review in less than or equal to 17 calendar months of the previous review. (R1.1) OR The Responsible Entity did not complete its approval of the one or more documented cyber security policies for its high impact and medium impact BES Cyber Systems as required by R1 by the CIP Senior Manager within 16 calendar months but did complete this approval in less than or equal to 17 calendar months of the previous approval. (R1.1)	calendar months of the previous review. (R1.1) OR The Responsible Entity did not complete its approval of the one or more documented cyber security policies for its high impact and medium impact BES Cyber Systems as required by R1 by the CIP Senior Manager within 17 calendar months but did complete this approval in less than or equal to 18 calendar months of the previous approval. (R1) OR The Responsible Entity documented one or more cyber security policies for its assets identified in CIP-002 containing low impact	complete its review of the one or more documented cyber security policies as required by R1 within 18 calendar months of the previous review. (R1) OR The Responsible Entity did not complete its approval of the one or more documented cyber security policies for its high impact and medium impact BES Cyber Systems as required by R1 by the CIP Senior Manager within 18 calendar months of the previous approval. (R1.1) OR

R #	Time Horizon	VRF	Violation Severity Levels (CIP-003-8)			
			Lower VSL	Moderate VSL	High VSL	Severe VSL
			<p>OR</p> <p>The Responsible Entity documented one or more cyber security policies for its assets identified in CIP-002 containing low impact BES Cyber Systems, but did not address one of the six topics required by R1. (R1.2)</p> <p>OR</p> <p>The Responsible Entity did not complete its review of the one or more documented cyber security policies for its assets identified in CIP-002 containing low impact BES Cyber Systems as required by Requirement R1 within 15 calendar</p>	<p>OR</p> <p>The Responsible Entity documented one or more cyber security policies for its assets identified in CIP-002 containing low impact BES Cyber Systems, but did not address two of the six topics required by R1. (R1.2)</p> <p>OR</p> <p>The Responsible Entity did not complete its review of the one or more documented cyber security policies for its assets identified in CIP-002 containing low impact BES Cyber Systems as required by Requirement R1 within 16 calendar</p>	<p>BES Cyber Systems, but did not address three of the six topics required by R1. (R1.2)</p> <p>OR</p> <p>The Responsible Entity did not complete its review of the one or more documented cyber security policies for its assets identified in CIP-002 containing low impact BES Cyber Systems as required by R1 within 17 calendar months but did complete this review in less than or equal to 18 calendar months of the previous review. (R1.2)</p> <p>OR</p> <p>The Responsible Entity did not complete its approval of the one or more documented cyber security policies for its</p>	<p>The Responsible Entity documented one or more cyber security policies for its assets identified in CIP-002 containing low impact BES Cyber Systems, but did not address four or more of the six topics required by R1. (R1.2)</p> <p>OR</p> <p>The Responsible Entity did not have any documented cyber security policies for its assets identified in CIP-002 containing low impact BES Cyber Systems as required by R1. (R1.2)</p> <p>OR</p> <p>The Responsible Entity did not</p>

R #	Time Horizon	VRF	Violation Severity Levels (CIP-003-8)			
			Lower VSL	Moderate VSL	High VSL	Severe VSL
			<p>months but did complete this review in less than or equal to 16 calendar months of the previous review. (R1.2)</p> <p>OR</p> <p>The Responsible Entity did not complete its approval of the one or more documented cyber security policies for its assets identified in CIP-002 containing low impact BES Cyber Systems as required by Requirement R1 by the CIP Senior Manager within 15 calendar months but did complete this approval in less than or equal to 16 calendar months of</p>	<p>months but did complete this review in less than or equal to 17 calendar months of the previous review. (R1.2)</p> <p>OR</p> <p>The Responsible Entity did not complete its approval of the one or more documented cyber security policies for its assets identified in CIP-002 containing low impact BES Cyber Systems as required by Requirement R1 by the CIP Senior Manager within 16 calendar months but did complete this approval in less than or equal to 17</p>	<p>assets identified in CIP-002 containing low impact BES Cyber Systems as required by Requirement R1 by the CIP Senior Manager within 17 calendar months but did complete this approval in less than or equal to 18 calendar months of the previous approval. (R1.2)</p>	<p>complete its approval of the one or more documented cyber security policies for its assets identified in CIP-002 containing low impact BES Cyber Systems as required by Requirement R1 by the CIP Senior Manager within 18 calendar months of the previous approval. (R1.2)</p>

R #	Time Horizon	VRF	Violation Severity Levels (CIP-003-8)			
			Lower VSL	Moderate VSL	High VSL	Severe VSL
			the previous approval. (R1.2)	calendar months of the previous approval. (R1.2)		
<b>R2</b>	<b>Operations Planning</b>	<b>Lower</b>	<p>The Responsible Entity documented its cyber security plan(s) for its assets containing low impact BES Cyber Systems, but failed to document cyber security awareness according to Requirement R2, Attachment 1, Section 1. (R2)</p> <p>OR</p> <p>The Responsible Entity implemented electronic access controls but failed to document its cyber security plan(s) for electronic access controls according to Requirement R2,</p>	<p>The Responsible Entity documented its cyber security plan(s) for its assets containing low impact BES Cyber Systems, but failed to reinforce cyber security practices at least once every 15 calendar months according to Requirement R2, Attachment 1, Section 1. (R2)</p> <p>OR</p> <p>The Responsible Entity documented its cyber security plan(s) for its assets containing low impact BES Cyber Systems, but failed</p>	<p>The Responsible Entity documented the physical access controls for its assets containing low impact BES Cyber Systems, but failed to implement the physical security controls according to Requirement R2, Attachment 1, Section 2. (R2)</p> <p>OR</p> <p>The Responsible Entity documented its cyber security plan(s) for electronic access controls for its assets containing low impact BES Cyber Systems, but failed to permit only necessary inbound and outbound electronic</p>	<p>The Responsible Entity failed to document and implement one or more cyber security plan(s) for its assets containing low impact BES Cyber Systems according to Requirement R2, Attachment 1. (R2)</p>

R #	Time Horizon	VRF	Violation Severity Levels (CIP-003-8)			
			Lower VSL	Moderate VSL	High VSL	Severe VSL
			<p>Attachment 1, Section 3. (R2)</p> <p>OR</p> <p>The Responsible Entity documented its cyber security plan(s) for its assets containing low impact BES Cyber Systems, but failed to document one or more Cyber Security Incident response plan(s) according to Requirement R2, Attachment 1, Section 4. (R2)</p> <p>OR</p> <p>The Responsible Entity documented one or more Cyber Security Incident response plan(s) within its cyber security plan(s) for its assets containing</p>	<p>to document physical security controls according to Requirement R2, Attachment 1, Section 2. (R2)</p> <p>OR</p> <p>The Responsible Entity documented its cyber security plan(s) for its assets containing low impact BES Cyber Systems, but failed to document electronic access controls according to Requirement R2, Attachment 1, Section 3. (R2)</p> <p>OR</p> <p>The Responsible Entity documented its cyber security plan(s) for electronic access controls but</p>	<p>access controls according to Requirement R2, Attachment 1, Section 3.1. (R2)</p> <p>OR</p> <p>The Responsible Entity documented one or more Cyber Security Incident response plan(s) within its cyber security plan(s) for its assets containing low impact BES Cyber Systems, but failed to test each Cyber Security Incident response plan(s) at least once every 36 calendar months according to Requirement R2, Attachment 1, Section 4. (R2)</p> <p>OR</p> <p>The Responsible Entity documented the determination of</p>	



R #	Time Horizon	VRF	Violation Severity Levels (CIP-003-8)			
			Lower VSL	Moderate VSL	High VSL	Severe VSL
			low impact BES Cyber Systems, but failed to update each Cyber Security Incident response plan(s) within 180 days according to Requirement R2, Attachment 1, Section 4. (R2) OR The Responsible Entity documented its plan(s) for Transient Cyber Assets and Removable Media, but failed to manage its Transient Cyber Asset(s) according to Requirement R2, Attachment 1, Section 5.1. (R2) OR The Responsible Entity documented	failed to implement authentication for all Dial-up Connectivity that provides access to low impact BES Cyber System(s), per Cyber Asset capability according to Requirement R2, Attachment 1, Section 3.2 (R2) OR The Responsible Entity documented one or more incident response plan(s) within its cyber security plan(s) for its assets containing low impact BES Cyber Systems, but failed to include the process for identification, classification, and response to Cyber Security Incidents	whether an identified Cyber Security Incident is a Reportable Cyber Security Incident, but failed to notify the Electricity Information Sharing and Analysis Center (E-ISAC) according to Requirement R2, Attachment 1, Section 4. (R2) OR The Responsible Entity documented its plan(s) for Transient Cyber Assets and Removable Media, but failed to implement mitigation for the introduction of malicious code for Transient Cyber Assets managed by the Responsible Entity according to Requirement R2,	

R #	Time Horizon	VRF	Violation Severity Levels (CIP-003-8)			
			Lower VSL	Moderate VSL	High VSL	Severe VSL
			its plan(s) for Transient Cyber Assets, but failed to document the Removable Media section(s) according to Requirement R2, Attachment 1, Section 5.3. (R2)	according to Requirement R2, Attachment 1, Section 4. (R2)  OR  The Responsible Entity documented its cyber security plan(s) for its assets containing low impact BES Cyber Systems, but failed to document the determination of whether an identified Cyber Security Incident is a Reportable Cyber Security Incident and subsequent notification to the Electricity Information Sharing and Analysis Center (E-ISAC) according to Requirement R2,	Attachment 1, Section 5.1. (R2)  OR  The Responsible Entity documented its plan(s) for Transient Cyber Assets and Removable Media, but failed to implement mitigation for the introduction of malicious code for Transient Cyber Assets managed by a party other than the Responsible Entity according to Requirement R2, Attachment 1, Section 5.2. (R2)  OR  The Responsible Entity documented its plan(s) for Transient Cyber Assets and Removable Media, but failed to implement mitigation for	

R #	Time Horizon	VRF	Violation Severity Levels (CIP-003-8)			
			Lower VSL	Moderate VSL	High VSL	Severe VSL
				<p>Attachment 1, Section 4. (R2)</p> <p>OR</p> <p>The Responsible Entity documented its plan(s) for Transient Cyber Assets and Removable Media, but failed to document mitigation for the introduction of malicious code for Transient Cyber Assets managed by the Responsible Entity according to Requirement R2, Attachment 1, Sections 5.1 and 5.3. (R2)</p> <p>OR</p> <p>The Responsible Entity documented its plan(s) for Transient Cyber</p>	<p>the threat of detected malicious code on the Removable Media prior to connecting Removable Media to a low impact BES Cyber System according to Requirement R2, Attachment 1, Section 5.3. (R2)</p>	

R #	Time Horizon	VRF	Violation Severity Levels (CIP-003-8)			
			Lower VSL	Moderate VSL	High VSL	Severe VSL
				<p>Assets and Removable Media, but failed to document mitigation for the introduction of malicious code for Transient Cyber Assets managed by a party other than the Responsible Entity according to Requirement R2, Attachment 1, Section 5.2. (R2)</p> <p>OR</p> <p>The Responsible Entity documented its plan(s) for Transient Cyber Assets and Removable Media, but failed to implement the Removable Media section(s) according to Requirement R2,</p>		

R #	Time Horizon	VRF	Violation Severity Levels (CIP-003-8)			
			Lower VSL	Moderate VSL	High VSL	Severe VSL
				Attachment 1, Section 5.3. (R2)		
<b>R3</b>	<b>Operations Planning</b>	<b>Medium</b>	The Responsible Entity has identified by name a CIP Senior Manager, but did not document changes to the CIP Senior Manager within 30 calendar days but did document this change in less than 40 calendar days of the change. (R3)	The Responsible Entity has identified by name a CIP Senior Manager, but did not document changes to the CIP Senior Manager within 40 calendar days but did document this change in less than 50 calendar days of the change. (R3)	The Responsible Entity has identified by name a CIP Senior Manager, but did not document changes to the CIP Senior Manager within 50 calendar days but did document this change in less than 60 calendar days of the change. (R3)	The Responsible Entity has not identified, by name, a CIP Senior Manager.  OR The Responsible Entity has identified by name a CIP Senior Manager, but did not document changes to the CIP Senior Manager within 60 calendar days of the change. (R3)
<b>R4</b>	<b>Operations Planning</b>	<b>Lower</b>	The Responsible Entity has identified a delegate by name, title, date of delegation, and specific actions delegated, but did	The Responsible Entity has identified a delegate by name, title, date of delegation, and specific actions delegated, but did	The Responsible Entity has identified a delegate by name, title, date of delegation, and specific actions delegated, but did not document changes to the delegate	The Responsible Entity has used delegated authority for actions where allowed by the CIP Standards, but does not have a process

R #	Time Horizon	VRF	Violation Severity Levels (CIP-003-8)			
			Lower VSL	Moderate VSL	High VSL	Severe VSL
			not document changes to the delegate within 30 calendar days but did document this change in less than 40 calendar days of the change. (R4)	not document changes to the delegate within 40 calendar days but did document this change in less than 50 calendar days of the change. (R4)	within 50 calendar days but did document this change in less than 60 calendar days of the change. (R4)	to delegate actions from the CIP Senior Manager. (R4)  OR The Responsible Entity has identified a delegate by name, title, date of delegation, and specific actions delegated, but did not document changes to the delegate within 60 calendar days of the change. (R4)

**D. Regional Variances**

None.

**E. Interpretations**

None.

**F. Associated Documents**

None.

## Version History

Version	Date	Action	Change Tracking
1	1/16/06	R3.2 — Change “Control Center” to “control center.”	3/24/06
2	9/30/09	<p>Modifications to clarify the requirements and to bring the compliance elements into conformance with the latest guidelines for developing compliance elements of standards.</p> <p>Removal of reasonable business judgment.</p> <p>Replaced the RRO with the RE as a responsible entity.</p> <p>Rewording of Effective Date.</p> <p>Changed compliance monitor to Compliance Enforcement Authority.</p>	
3	12/16/09	<p>Updated Version Number from -2 to -3</p> <p>In Requirement 1.6, deleted the sentence pertaining to removing component or system from service in order to perform testing, in response to FERC order issued September 30, 2009.</p>	
3	12/16/09	Approved by the NERC Board of Trustees.	
3	3/31/10	Approved by FERC.	
4	1/24/11	Approved by the NERC Board of Trustees.	
5	11/26/12	Adopted by the NERC Board of Trustees.	Modified to coordinate with other CIP standards and to revise format to use RBS Template.
5	11/22/13	FERC Order issued approving CIP-003-5.	

Version	Date	Action	Change Tracking
6	11/13/14	Adopted by the NERC Board of Trustees.	Addressed two FERC directives from Order No. 791 related to identify, assess, and correct language and communication networks.
6	2/12/15	Adopted by the NERC Board of Trustees.	Replaces the version adopted by the Board on 11/13/2014. Revised version addresses remaining directives from Order No. 791 related to transient devices and low impact BES Cyber Systems.
6	1/21/16	FERC Order issued approving CIP-003-6. Docket No. RM15-14-000	
7	2/9/17	Adopted by the NERC Board of Trustees.	Revised to address FERC Order No. 822 directives regarding (1) the definition of LERC and (2) transient devices.
7	4/19/18	FERC Order issued approving CIP-003-7. Docket No. RM17-11-000	



Version	Date	Action	Change Tracking
8		FERC Order issued approving CIP-003-7. Docket No. RM17-11-000	

## Attachment 1

### Required Sections for Cyber Security Plan(s) for Assets Containing Low Impact BES Cyber Systems

Responsible Entities shall include each of the sections provided below in the cyber security plan(s) required under Requirement R2.

Responsible Entities with multiple-impact BES Cyber Systems ratings can utilize policies, procedures, and processes for their high or medium impact BES Cyber Systems to fulfill the sections for the development of low impact cyber security plan(s). Each Responsible Entity can develop a cyber security plan(s) either by individual asset or groups of assets.

**Section 1.** Cyber Security Awareness: Each Responsible Entity shall reinforce, at least once every 15 calendar months, cyber security practices (which may include associated physical security practices).

**Section 2.** Physical Security Controls: Each Responsible Entity shall control physical access, based on need as determined by the Responsible Entity, to (1) the asset or the locations of the low impact BES Cyber Systems within the asset, and (2) the Cyber Asset(s), as specified by the Responsible Entity, that provide electronic access control(s) implemented for Section 3.1, if any.

**Section 3.** Electronic Access Controls: For each asset containing low impact BES Cyber System(s) identified pursuant to CIP-002, the Responsible Entity shall implement electronic access controls to:

- 3.1** Permit only necessary inbound and outbound electronic access as determined by the Responsible Entity for any communications that are:
  - i. between a low impact BES Cyber System(s) and a Cyber Asset(s) outside the asset containing low impact BES Cyber System(s);
  - ii. using a routable protocol when entering or leaving the asset containing the low impact BES Cyber System(s); and
  - iii. not used for time-sensitive protection or control functions between intelligent electronic devices (e.g., communications using protocol IEC TR-61850-90-5 R-GOOSE).
- 3.2** Authenticate all Dial-up Connectivity, if any, that provides access to low impact BES Cyber System(s), per Cyber Asset capability.

**Section 4.** Cyber Security Incident Response: Each Responsible Entity shall have one or more Cyber Security Incident response plan(s), either by asset or group of assets, which shall include:

- 4.1** Identification, classification, and response to Cyber Security Incidents;
- 4.2** Determination of whether an identified Cyber Security Incident is a Reportable Cyber Security Incident and subsequent notification to the

Electricity Information Sharing and Analysis Center (E-ISAC), unless prohibited by law;

- 4.3 Identification of the roles and responsibilities for Cyber Security Incident response by groups or individuals;
- 4.4 Incident handling for Cyber Security Incidents;
- 4.5 Testing the Cyber Security Incident response plan(s) at least once every 36 calendar months by: (1) responding to an actual Reportable Cyber Security Incident; (2) using a drill or tabletop exercise of a Reportable Cyber Security Incident; or (3) using an operational exercise of a Reportable Cyber Security Incident; and
- 4.6 Updating the Cyber Security Incident response plan(s), if needed, within 180 calendar days after completion of a Cyber Security Incident response plan(s) test or actual Reportable Cyber Security Incident.

**Section 5. Transient Cyber Asset and Removable Media Malicious Code Risk Mitigation:** Each Responsible Entity shall implement, except under CIP Exceptional Circumstances, one or more plan(s) to achieve the objective of mitigating the risk of the introduction of malicious code to low impact BES Cyber Systems through the use of Transient Cyber Assets or Removable Media. The plan(s) shall include:

- 5.1 For Transient Cyber Asset(s) managed by the Responsible Entity, if any, the use of one or a combination of the following in an ongoing or on-demand manner (per Transient Cyber Asset capability):
  - Antivirus software, including manual or managed updates of signatures or patterns;
  - Application whitelisting; or
  - Other method(s) to mitigate the introduction of malicious code.
- 5.2 For Transient Cyber Asset(s) managed by a party other than the Responsible Entity, if any:
  - 5.2.1 Use one or a combination of the following prior to connecting the Transient Cyber Asset to a low impact BES Cyber System (per Transient Cyber Asset capability):
    - Review of antivirus update level;
    - Review of antivirus update process used by the party;
    - Review of application whitelisting used by the party;
    - Review use of live operating system and software executable only from read-only media;
    - Review of system hardening used by the party; or

- Other method(s) to mitigate the introduction of malicious code.
- 5.2.2** For any method used pursuant to 5.2.1, Responsible Entities shall determine whether any additional mitigation actions are necessary and implement such actions prior to connecting the Transient Cyber Asset.
- 5.3** For Removable Media, the use of each of the following:
- 5.3.1** Method(s) to detect malicious code on Removable Media using a Cyber Asset other than a BES Cyber System; and
  - 5.3.2** Mitigation of the threat of detected malicious code on the Removable Media prior to connecting Removable Media to a low impact BES Cyber System.

## Attachment 2

### Examples of Evidence for Cyber Security Plan(s) for Assets Containing Low Impact BES Cyber Systems

**Section 1. Cyber Security Awareness:** An example of evidence for Section 1 may include, but is not limited to, documentation that the reinforcement of cyber security practices occurred at least once every 15 calendar months. The evidence could be documentation through one or more of the following methods:

- Direct communications (for example, e-mails, memos, or computer-based training);
- Indirect communications (for example, posters, intranet, or brochures); or
- Management support and reinforcement (for example, presentations or meetings).

**Section 2. Physical Security Controls:** Examples of evidence for Section 2 may include, but are not limited to:

- Documentation of the selected access control(s) (e.g., card key, locks, perimeter controls), monitoring controls (e.g., alarm systems, human observation), or other operational, procedural, or technical physical security controls that control physical access to both:
  - a. The asset, if any, or the locations of the low impact BES Cyber Systems within the asset; and
  - b. The Cyber Asset(s) specified by the Responsible Entity that provide(s) electronic access controls implemented for Attachment 1, Section 3.1, if any.

**Section 3. Electronic Access Controls:** Examples of evidence for Section 3 may include, but are not limited to:

1. Documentation showing that at each asset or group of assets containing low impact BES Cyber Systems, routable communication between a low impact BES Cyber System(s) and a Cyber Asset(s) outside the asset is restricted by electronic access controls to permit only inbound and outbound electronic access that the Responsible Entity deems necessary, except where an entity provides rationale that communication is used for time-sensitive protection or control functions between intelligent electronic devices. Examples of such documentation may include, but are not limited to representative diagrams that illustrate control of inbound and outbound communication(s) between the low impact BES Cyber System(s) and a Cyber Asset(s) outside the asset containing low impact BES Cyber System(s) or lists of implemented electronic access controls (e.g., access control lists restricting IP addresses, ports, or services; implementing unidirectional gateways).

2. Documentation of authentication for Dial-up Connectivity (e.g., dial out only to a preprogrammed number to deliver data, dial-back modems, modems that must be remotely controlled by the control center or control room, or access control on the BES Cyber System).

**Section 4. Cyber Security Incident Response:** An example of evidence for Section 4 may include, but is not limited to, dated documentation, such as policies, procedures, or process documents of one or more Cyber Security Incident response plan(s) developed either by asset or group of assets that include the following processes:

1. to identify, classify, and respond to Cyber Security Incidents; to determine whether an identified Cyber Security Incident is a Reportable Cyber Security Incident and for notifying the Electricity Information Sharing and Analysis Center (E-ISAC);
2. to identify and document the roles and responsibilities for Cyber Security Incident response by groups or individuals (e.g., initiating, documenting, monitoring, reporting, etc.);
3. for incident handling of a Cyber Security Incident (e.g., containment, eradication, or recovery/incident resolution);
4. for testing the plan(s) along with the dated documentation that a test has been completed at least once every 36 calendar months; and
5. to update, as needed, Cyber Security Incident response plan(s) within 180 calendar days after completion of a test or actual Reportable Cyber Security Incident.

**Section 5. Transient Cyber Asset and Removable Media Malicious Code Risk Mitigation:**

1. Examples of evidence for Section 5.1 may include, but are not limited to, documentation of the method(s) used to mitigate the introduction of malicious code such as antivirus software and processes for managing signature or pattern updates, application whitelisting practices, processes to restrict communication, or other method(s) to mitigate the introduction of malicious code. If a Transient Cyber Asset does not have the capability to use method(s) that mitigate the introduction of malicious code, evidence may include documentation by the vendor or Responsible Entity that identifies that the Transient Cyber Asset does not have the capability.
2. Examples of evidence for Section 5.2.1 may include, but are not limited to, documentation from change management systems, electronic mail or procedures that document a review of the installed antivirus update level; memoranda, electronic mail, system documentation, policies or contracts from the party other than the Responsible Entity that identify the antivirus update process, the use of application whitelisting, use of live operating systems or system hardening performed by the party other than the Responsible Entity; evidence from change management systems, electronic mail or contracts that

identifies the Responsible Entity's acceptance that the practices of the party other than the Responsible Entity are acceptable; or documentation of other method(s) to mitigate malicious code for Transient Cyber Asset(s) managed by a party other than the Responsible Entity. If a Transient Cyber Asset does not have the capability to use method(s) that mitigate the introduction of malicious code, evidence may include documentation by the Responsible Entity or the party other than the Responsible Entity that identifies that the Transient Cyber Asset does not have the capability.

Examples of evidence for Attachment 1, Section 5.2.2 may include, but are not limited to, documentation from change management systems, electronic mail, or contracts that identifies a review to determine whether additional mitigation is necessary and has been implemented prior to connecting the Transient Cyber Asset managed by a party other than the Responsible Entity.

3. Examples of evidence for Section 5.3.1 may include, but are not limited to, documented process(es) of the method(s) used to detect malicious code such as results of scan settings for Removable Media, or implementation of on-demand scanning. Examples of evidence for Section 5.3.2 may include, but are not limited to, documented process(es) for the method(s) used for mitigating the threat of detected malicious code on Removable Media, such as logs from the method(s) used to detect malicious code that show the results of scanning and the mitigation of detected malicious code on Removable Media or documented confirmation by the entity that the Removable Media was deemed to be free of malicious code.

## Guidelines and Technical Basis

### Section 4 – Scope of Applicability of the CIP Cyber Security Standards

Section “4. Applicability” of the standards provides important information for Responsible Entities to determine the scope of the applicability of the CIP Cyber Security Requirements.

Section “4.1. Functional Entities” is a list of NERC functional entities to which the standard applies. If the entity is registered as one or more of the functional entities listed in Section 4.1, then the NERC CIP Cyber Security Standards apply. Note that there is a qualification in Section 4.1 that restricts the applicability in the case of Distribution Providers to only those that own certain types of systems and equipment listed in 4.2.

Section “4.2. Facilities” defines the scope of the Facilities, systems, and equipment owned by the Responsible Entity, as qualified in Section 4.1, that is subject to the requirements of the standard. In addition to the set of BES Facilities, Control Centers, and other systems and equipment, the list includes the set of systems and equipment owned by Distribution Providers. While the NERC Glossary term “Facilities” already includes the BES characteristic, the additional use of the term BES here is meant to reinforce the scope of applicability of these Facilities where it is used, especially in this applicability scoping section. This in effect sets the scope of Facilities, systems, and equipment that is subject to the standards.

#### Requirement R1:

In developing policies in compliance with Requirement R1, the number of policies and their content should be guided by a Responsible Entity's management structure and operating conditions. Policies might be included as part of a general information security program for the entire organization, or as components of specific programs. The Responsible Entity has the flexibility to develop a single comprehensive cyber security policy covering the required topics, or it may choose to develop a single high-level umbrella policy and provide additional policy detail in lower level documents in its documentation hierarchy. In the case of a high-level umbrella policy, the Responsible Entity would be expected to provide the high-level policy as well as the additional documentation in order to demonstrate compliance with CIP-003-8, Requirement R1.

If a Responsible Entity has any high or medium impact BES Cyber Systems, the one or more cyber security policies must cover the nine subject matter areas required by CIP-003-8, Requirement R1, Part 1.1. If a Responsible Entity has identified from CIP-002 any assets containing low impact BES Cyber Systems, the one or more cyber security policies must cover the six subject matter areas required by Requirement R1, Part 1.2.

Responsible Entities that have multiple-impact rated BES Cyber Systems are not required to create separate cyber security policies for high, medium, or low impact BES Cyber Systems. The Responsible Entities have the flexibility to develop policies that cover all three impact ratings.

Implementation of the cyber security policy is not specifically included in CIP-003-8, Requirement R1 as it is envisioned that the implementation of this policy is evidenced through successful implementation of CIP-003 through CIP-011. However, Responsible Entities are encouraged not to limit the scope of their cyber security policies to only those requirements in NERC cyber security Reliability Standards, but to develop a holistic cyber security policy



appropriate for its organization. Elements of a policy that extend beyond the scope of NERC's cyber security Reliability Standards will not be considered candidates for potential violations although they will help demonstrate the organization's internal culture of compliance and posture towards cyber security.

For Part 1.1, the Responsible Entity may consider the following for each of the required topics in its one or more cyber security policies for medium and high impact BES Cyber Systems, if any:

### 1.1.1 Personnel and training (CIP-004)

- Organization position on acceptable background investigations
- Identification of possible disciplinary action for violating this policy
- Account management

### 1.1.2 Electronic Security Perimeters (CIP-005) including Interactive Remote Access

- Organization stance on use of wireless networks
- Identification of acceptable authentication methods
- Identification of trusted and untrusted resources
- Monitoring and logging of ingress and egress at Electronic Access Points
- Maintaining up-to-date anti-malware software before initiating Interactive Remote Access
- Maintaining up-to-date patch levels for operating systems and applications used to initiate Interactive Remote Access
- Disabling VPN "split-tunneling" or "dual-homed" workstations before initiating Interactive Remote Access
- For vendors, contractors, or consultants: include language in contracts that requires adherence to the Responsible Entity's Interactive Remote Access controls

### 1.1.3 Physical security of BES Cyber Systems (CIP-006)

- Strategy for protecting Cyber Assets from unauthorized physical access
- Acceptable physical access control methods
- Monitoring and logging of physical ingress

### 1.1.4 System security management (CIP-007)

- Strategies for system hardening
- Acceptable methods of authentication and access control
- Password policies including length, complexity, enforcement, prevention of brute force attempts
- Monitoring and logging of BES Cyber Systems

- 1.1.5 Incident reporting and response planning (CIP-008)
  - Recognition of Cyber Security Incidents
  - Appropriate notifications upon discovery of an incident
  - Obligations to report Cyber Security Incidents
- 1.1.6 Recovery plans for BES Cyber Systems (CIP-009)
  - Availability of spare components
  - Availability of system backups
- 1.1.7 Configuration change management and vulnerability assessments (CIP-010)
  - Initiation of change requests
  - Approval of changes
  - Break-fix processes
- 1.1.8 Information protection (CIP-011)
  - Information access control methods
  - Notification of unauthorized information disclosure
  - Information access on a need-to-know basis
- 1.1.9 Declaring and responding to CIP Exceptional Circumstances
  - Processes to invoke special procedures in the event of a CIP Exceptional Circumstance
  - Processes to allow for exceptions to policy that do not violate CIP requirements

For Part 1.2, the Responsible Entity may consider the following for each of the required topics in its one or more cyber security policies for assets containing low impact BES Cyber Systems, if any:

- 1.2.1 Cyber security awareness
  - Method(s) for delivery of security awareness
  - Identification of groups to receive cyber security awareness
- 1.2.2 Physical security controls
  - Acceptable approach(es) for selection of physical security control(s)
- 1.2.3 Electronic access controls
  - Acceptable approach(es) for selection of electronic access control(s)
- 1.2.4 Cyber Security Incident response
  - Recognition of Cyber Security Incidents

- Appropriate notifications upon discovery of an incident
- Obligations to report Cyber Security Incidents

### 1.2.5 Transient Cyber Assets and Removable Media Malicious Code Risk Mitigation

- Acceptable use of Transient Cyber Asset(s) and Removable Media
- Method(s) to mitigate the risk of the introduction of malicious code to low impact BES Cyber Systems from Transient Cyber Assets and Removable Media
- Method(s) to request Transient Cyber Asset and Removable Media

### 1.2.6 Declaring and responding to CIP Exceptional Circumstances

- Process(es) to declare a CIP Exceptional Circumstance
- Process(es) to respond to a declared CIP Exceptional Circumstance

Requirements relating to exceptions to a Responsible Entity's security policies were removed because it is a general management issue that is not within the scope of a reliability requirement. It is an internal policy requirement and not a reliability requirement. However, Responsible Entities are encouraged to continue this practice as a component of their cyber security policies.

In this and all subsequent required approvals in the NERC CIP Reliability Standards, the Responsible Entity may elect to use hardcopy or electronic approvals to the extent that there is sufficient evidence to ensure the authenticity of the approving party.

#### **Requirement R2:**

The intent of Requirement R2 is for each Responsible Entity to create, document, and implement one or more cyber security plan(s) that address the security objective for the protection of low impact BES Cyber Systems. The required protections are designed to be part of a program that covers the low impact BES Cyber Systems collectively at an asset level (based on the list of assets containing low impact BES Cyber Systems identified in CIP-002), but not at an individual device or system level.

#### **Requirement R2, Attachment 1**

As noted, Attachment 1 contains the sections that must be included in the cyber security plan(s). The intent is to allow entities that have a combination of high, medium, and low impact BES Cyber Systems the flexibility to choose, if desired, to cover their low impact BES Cyber Systems (or any subset) under their programs used for the high or medium impact BES Cyber Systems rather than maintain two separate programs. The purpose of the cyber security plan(s) in Requirement R2 is for Responsible Entities to use the cyber security plan(s) as a means of documenting their approaches to meeting the subject matter areas. The cyber security plan(s) can be used to reference other policies and procedures that demonstrate "how" the Responsible Entity is meeting each of the subject matter areas, or Responsible Entities can develop comprehensive cyber security plan(s) that contain all of the detailed implementation content solely within the cyber security plan itself. To meet the obligation for the cyber security plan, the expectation is that the cyber security plan contains or references sufficient details to address the implementation of each of the required subject matters areas.

Guidance for each of the subject matter areas of Attachment 1 is provided below.

### **Requirement R2, Attachment 1, Section 1 – Cyber Security Awareness**

The intent of the cyber security awareness program is for entities to reinforce good cyber security practices with their personnel at least once every 15 calendar months. The entity has the discretion to determine the topics to be addressed and the manner in which it will communicate these topics. As evidence of compliance, the Responsible Entity should be able to produce the awareness material that was delivered according to the delivery method(s) (e.g., posters, emails, or topics at staff meetings, etc.). The standard drafting team does not intend for Responsible Entities to be required to maintain lists of recipients and track the reception of the awareness material by personnel.

Although the focus of the awareness is cyber security, it does not mean that only technology-related topics can be included in the program. Appropriate physical security topics (e.g., tailgating awareness and protection of badges for physical security, or “If you see something, say something” campaigns, etc.) are valid for cyber security awareness. The intent is to cover topics concerning any aspect of the protection of BES Cyber Systems.

### **Requirement R2, Attachment 1, Section 2 – Physical Security Controls**

The Responsible Entity must document and implement methods to control physical access to (1) the asset or the locations of low impact BES Cyber Systems within the asset, and (2) Cyber Assets that implement the electronic access control(s) specified by the Responsible Entity in Attachment 1, Section 3.1, if any. If these Cyber Assets implementing the electronic access controls are located within the same asset as the low impact BES Cyber Asset(s) and inherit the same physical access controls and the same need as outlined in Section 2, this may be noted by the Responsible Entity in either its policies or cyber security plan(s) to avoid duplicate documentation of the same controls.

The Responsible Entity has the flexibility to select the methods used to meet the objective of controlling physical access to (1) the asset(s) containing low impact BES Cyber System(s) or the low impact BES Cyber Systems themselves and (2) the electronic access control Cyber Assets specified by the Responsible Entity, if any. The Responsible Entity may use one or a combination of physical access controls, monitoring controls, or other operational, procedural, or technical physical security controls. Entities may use perimeter controls (e.g., fences with locked gates, guards, or site access policies, etc.) or more granular areas of physical access control in areas where low impact BES Cyber Systems are located, such as control rooms or control houses.

The security objective is to control the physical access based on need as determined by the Responsible Entity. The need for physical access can be documented at the policy level. The standard drafting team did not intend to obligate an entity to specify a need for each physical access or authorization of an individual for physical access.

Monitoring as a physical security control can be used as a complement or an alternative to physical access control. Examples of monitoring controls include, but are not limited to: (1) alarm systems to detect motion or entry into a controlled area, or (2) human observation of a controlled area. Monitoring does not necessarily require logging and maintaining logs but could

include monitoring that physical access has occurred or been attempted (e.g., door alarm, or human observation, etc.). The standard drafting team's intent is that the monitoring does not need to be per low impact BES Cyber System but should be at the appropriate level to meet the security objective of controlling physical access.

User authorization programs and lists of authorized users for physical access are not required although they are an option to meet the security objective.

### **Requirement R2, Attachment 1, Section 3 – Electronic Access Controls**

Section 3 requires the establishment of electronic access controls for assets containing low impact BES Cyber Systems when there is routable protocol communication or Dial-up Connectivity between Cyber Asset(s) outside of the asset containing the low impact BES Cyber System(s) and the low impact BES Cyber System(s) within such asset. The establishment of electronic access controls is intended to reduce the risks associated with uncontrolled communication using routable protocols or Dial-up Connectivity.

When implementing Attachment 1, Section 3.1, Responsible Entities should note that electronic access controls to permit only necessary inbound and outbound electronic access are required for communications when those communications meet all three of the criteria identified in Attachment 1, Section 3.1. The Responsible Entity should evaluate the communications and when all three criteria are met, the Responsible Entity must document and implement electronic access control(s).

When identifying electronic access controls, Responsible Entities are provided flexibility in the selection of the electronic access controls that meet their operational needs while meeting the security objective of allowing only necessary inbound and outbound electronic access to low impact BES Cyber Systems that use routable protocols between a low impact BES Cyber System(s) and Cyber Asset(s) outside the asset.

In essence, the intent is for Responsible Entities to determine whether there is communication between a low impact BES Cyber System(s) and a Cyber Asset(s) outside the asset containing low impact BES Cyber System(s) that uses a routable protocol when entering or leaving the asset or Dial-up Connectivity to the low impact BES Cyber System(s). Where such communication is present, Responsible Entities should document and implement electronic access control(s). Where routable protocol communication for time-sensitive protection or control functions between intelligent electronic devices that meets the exclusion language is present, Responsible Entities should document that communication, but are not required to establish any specific electronic access controls.

The inputs to this requirement are the assets identified in CIP-002 as containing low impact BES Cyber System(s); therefore, the determination of routable protocol communications or Dial-up Connectivity is an attribute of the asset. However, it is not intended for communication that provides no access to or from the low impact BES Cyber System(s), but happens to be located at the asset with the low impact BES Cyber System(s), to be evaluated for electronic access controls.

### Electronic Access Control Exclusion

In order to avoid future technology issues, the obligations for electronic access controls exclude communications between intelligent electronic devices that use routable communication protocols for time-sensitive protection or control functions, such as IEC TR-61850-90-5 R-GOOSE messaging. Time-sensitive in this context generally means functions that would be negatively impacted by the latency introduced in the communications by the required electronic access controls. This time-sensitivity exclusion does not apply to SCADA communications which typically operate on scan rates of 2 seconds or greater. While technically time-sensitive, SCADA communications over routable protocols can withstand the delay introduced by electronic access controls. Examples of excluded time-sensitive communications are those communications which may necessitate the tripping of a breaker within a few cycles. A Responsible Entity using this technology is not expected to implement the electronic access controls noted herein. This exception was included so as not to inhibit the functionality of the time-sensitive characteristics related to this technology and not to preclude the use of such time-sensitive reliability enhancing functions if they use a routable protocol in the future.

### **Considerations for Determining Routable Protocol Communications**

To determine whether electronic access controls need to be implemented, the Responsible Entity has to determine whether there is communication between a low impact BES Cyber System(s) and a Cyber Asset(s) outside the asset containing the low impact BES Cyber System(s) that uses a routable protocol when entering or leaving the asset.

When determining whether a routable protocol is entering or leaving the asset containing the low impact BES Cyber System(s), Responsible Entities have flexibility in identifying an approach. One approach is for Responsible Entities to identify an “electronic boundary” associated with the asset containing low impact BES Cyber System(s). This is not an Electronic Security Perimeter *per se*, but a demarcation that demonstrates the routable protocol communication entering or leaving the asset between a low impact BES Cyber System and Cyber Asset(s) outside the asset to then have electronic access controls implemented. This electronic boundary may vary by asset type (Control Center, substation, generation resource) and the specific configuration of the asset. If this approach is used, the intent is for the Responsible Entity to define the electronic boundary such that the low impact BES Cyber System(s) located at the asset are contained within the “electronic boundary.” This is strictly for determining which routable protocol communications and networks are internal or inside or local to the asset and which are external to or outside the asset.

Alternatively, the Responsible Entity may find the concepts of what is inside and outside to be intuitively obvious for a Cyber Asset(s) outside the asset containing low impact BES Cyber System(s) communicating to a low impact BES Cyber System(s) inside the asset. This may be the case when a low impact BES Cyber System(s) is communicating with a Cyber Asset many miles away and a clear and unambiguous demarcation exists. In this case, a Responsible Entity may decide not to identify an “electronic boundary,” but rather to simply leverage the unambiguous asset demarcation to ensure that the electronic access controls are placed between the low impact BES Cyber System(s) and the Cyber Asset(s) outside the asset.

### **Determining Electronic Access Controls**

Once a Responsible Entity has determined that there is routable communication between a low impact BES Cyber System(s) and a Cyber Asset(s) outside the asset containing the low impact BES Cyber System(s) that uses a routable protocol when entering or leaving the asset containing the low impact BES Cyber System(s), the intent is for the Responsible Entity to document and implement its chosen electronic access control(s). The control(s) are intended to allow only “necessary” inbound and outbound electronic access as determined by the Responsible Entity. However the Responsible Entity chooses to document the inbound and outbound access permissions and the need, the intent is that the Responsible Entity is able to explain the reasons for the electronic access permitted. The reasoning for “necessary” inbound and outbound electronic access controls may be documented within the Responsible Entity’s cyber security plan(s), within a comment on an access control list, a database, spreadsheet or other policies or procedures associated with the electronic access controls.

### **Concept Diagrams**

The diagrams on the following pages are provided as examples to illustrate various electronic access controls at a conceptual level. Regardless of the concepts or configurations chosen by the Responsible Entity, the intent is to achieve the security objective of permitting only necessary inbound and outbound electronic access for communication between low impact BES Cyber Systems and Cyber Asset(s) outside the asset containing the low impact BES Cyber System(s) using a routable protocol when entering or leaving the asset.

#### **NOTE:**

- This is not an exhaustive list of applicable concepts.
- The same legend is used in each diagram; however, the diagram may not contain all of the articles represented in the legend.

### Reference Model 1 – Host-based Inbound & Outbound Access Permissions

The Responsible Entity may choose to utilize a host-based firewall technology on the low impact BES Cyber System(s) itself that manages the inbound and outbound electronic access permissions so that only necessary inbound and outbound electronic access is allowed between the low impact BES Cyber System(s) and the Cyber Asset(s) outside the asset containing the low impact BES Cyber System(s). When permitting the inbound and outbound electronic access permissions using access control lists, the Responsible Entity could restrict communication(s) using source and destination addresses or ranges of addresses. Responsible Entities could also restrict communication(s) using ports or services based on the capability of the electronic access control, the low impact BES Cyber System(s), or the application(s).

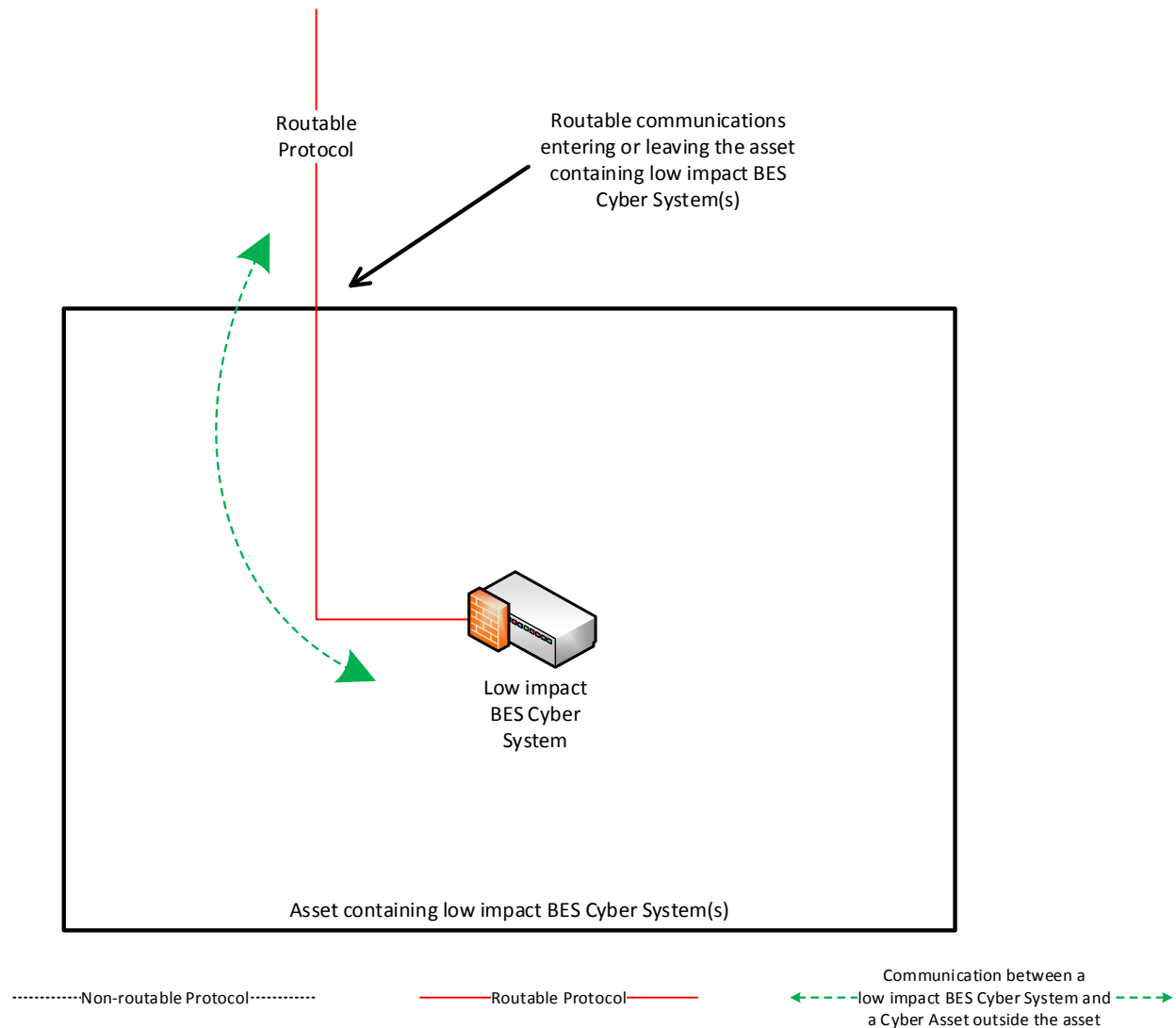

*Reference Model 1*



**Reference Model 2 – Network-based Inbound & Outbound Access Permissions**

The Responsible Entity may choose to use a security device that permits only necessary inbound and outbound electronic access to the low impact BES Cyber System(s) within the asset containing the low impact BES Cyber System(s). In this example, two low impact BES Cyber Systems are accessed using the routable protocol that is entering or leaving the asset containing the low impact BES Cyber System(s). The IP/Serial converter is continuing the same communications session from the Cyber Asset(s) that are outside the asset to the low impact BES Cyber System(s). The security device provides the electronic access controls to permit only necessary inbound and outbound routable protocol access to the low impact BES Cyber System(s). When permitting the inbound and outbound electronic access permissions using access control lists, the Responsible Entity could restrict communication(s) using source and destination addresses or ranges of addresses. Responsible Entities could also restrict communication(s) using ports or services based on the capability of the electronic access control, the low impact BES Cyber System(s), or the application(s).

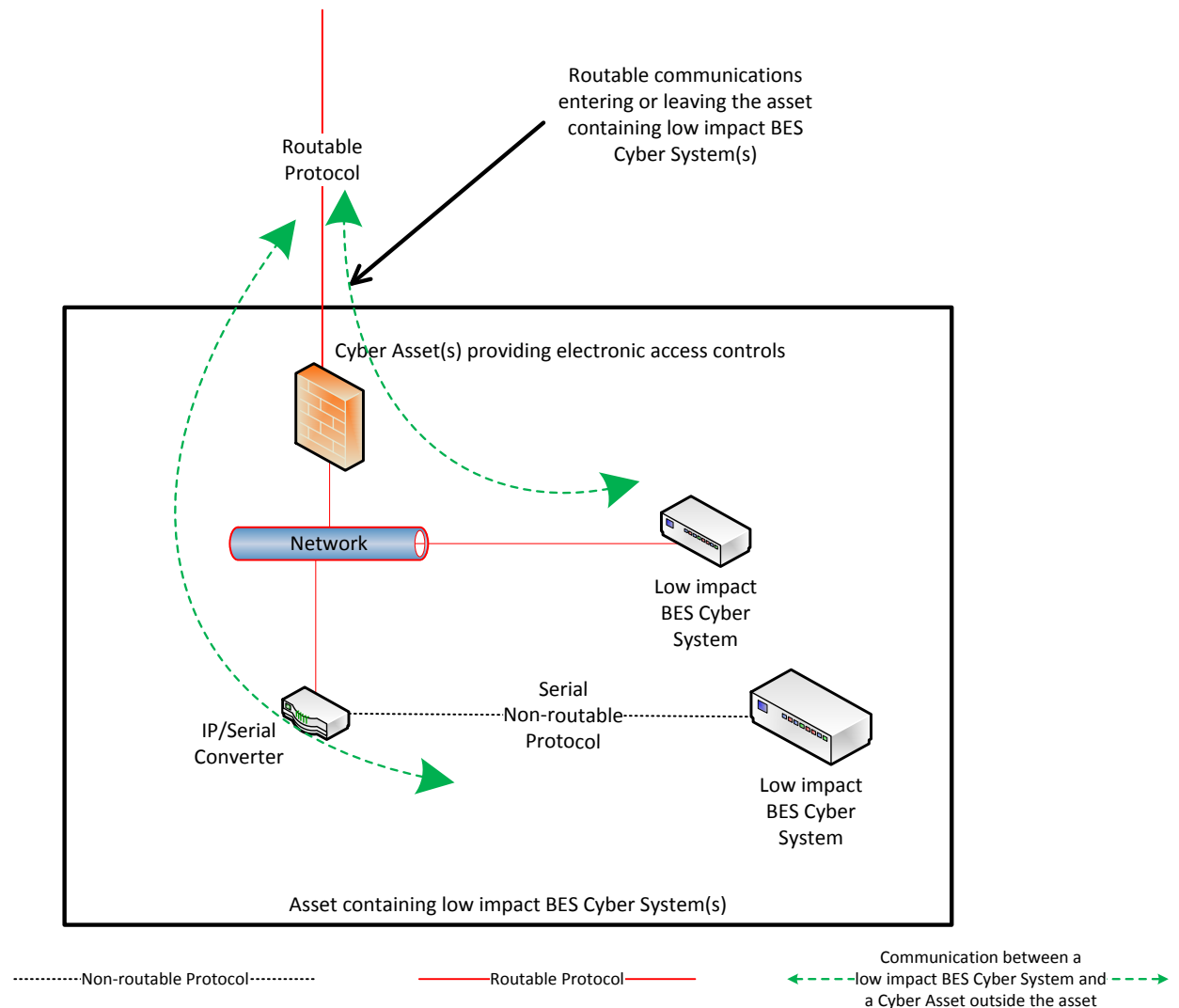

*Reference Model 2*

### Reference Model 3 – Centralized Network-based Inbound & Outbound Access Permissions

The Responsible Entity may choose to utilize a security device at a centralized location that may or may not be at another asset containing low impact BES Cyber System(s). The electronic access control(s) do not necessarily have to reside inside the asset containing the low impact BES Cyber System(s). A security device is in place at “Location X” to act as the electronic access control and permit only necessary inbound and outbound routable protocol access between the low impact BES Cyber System(s) and the Cyber Asset(s) outside each asset containing low impact BES Cyber System(s). Care should be taken that electronic access to or between each asset is through the Cyber Asset(s) determined by the Responsible Entity to be performing electronic access controls at the centralized location. When permitting the inbound and outbound electronic access permissions using access control lists, the Responsible Entity could restrict communication(s) using source and destination addresses or ranges of addresses. Responsible Entities could also restrict communication(s) using ports or services based on the capability of the electronic access control, the low impact BES Cyber System(s), or the application(s).

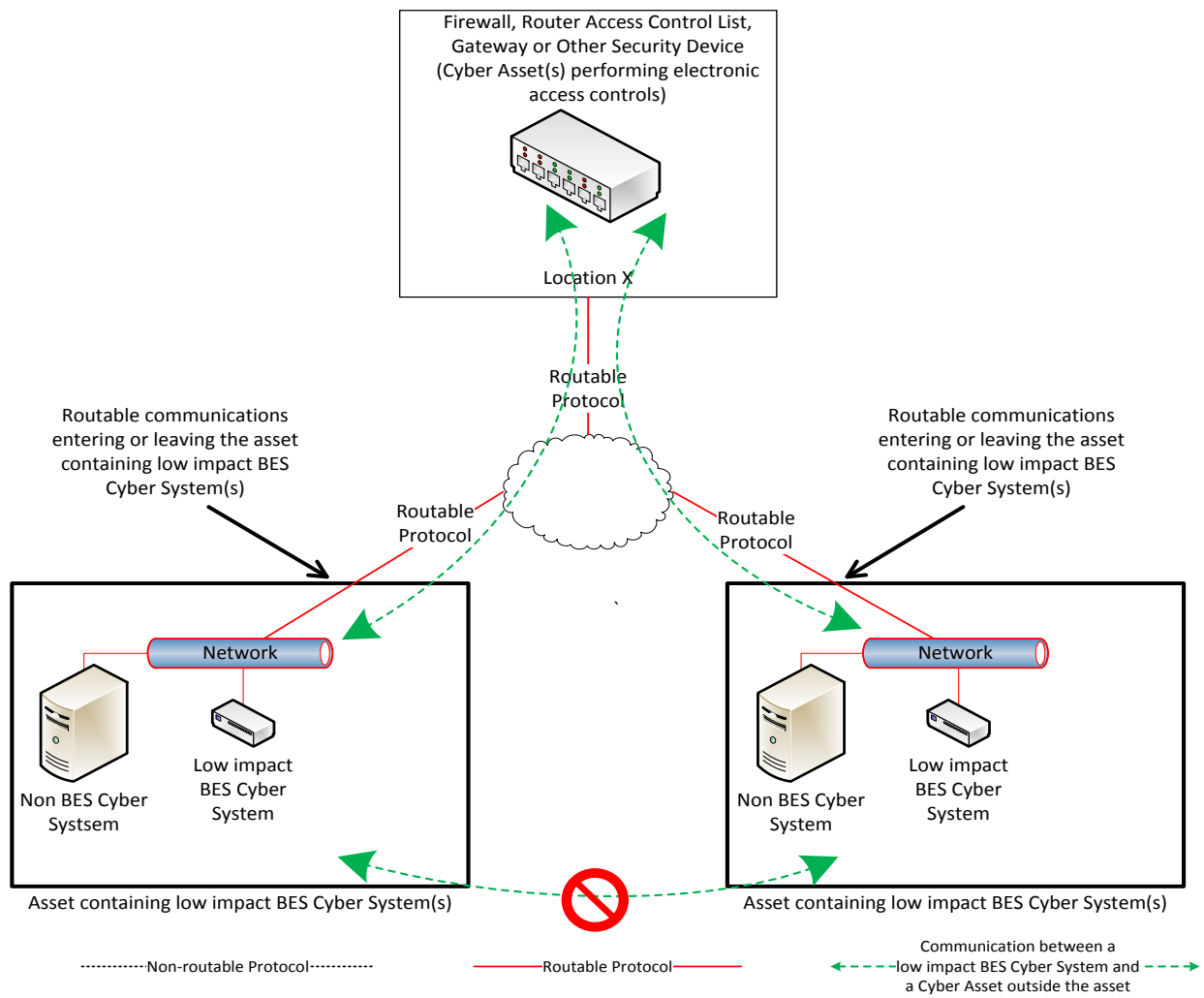

Reference Model 3

### Reference Model 4 – Uni-directional Gateway

The Responsible Entity may choose to utilize a uni-directional gateway as the electronic access control. The low impact BES Cyber System(s) is not accessible (data cannot flow into the low impact BES Cyber System) using the routable protocol entering the asset due to the implementation of a “one-way” (uni-directional) path for data to flow. The uni-directional gateway is configured to permit only the necessary outbound communications using the routable protocol communication leaving the asset.

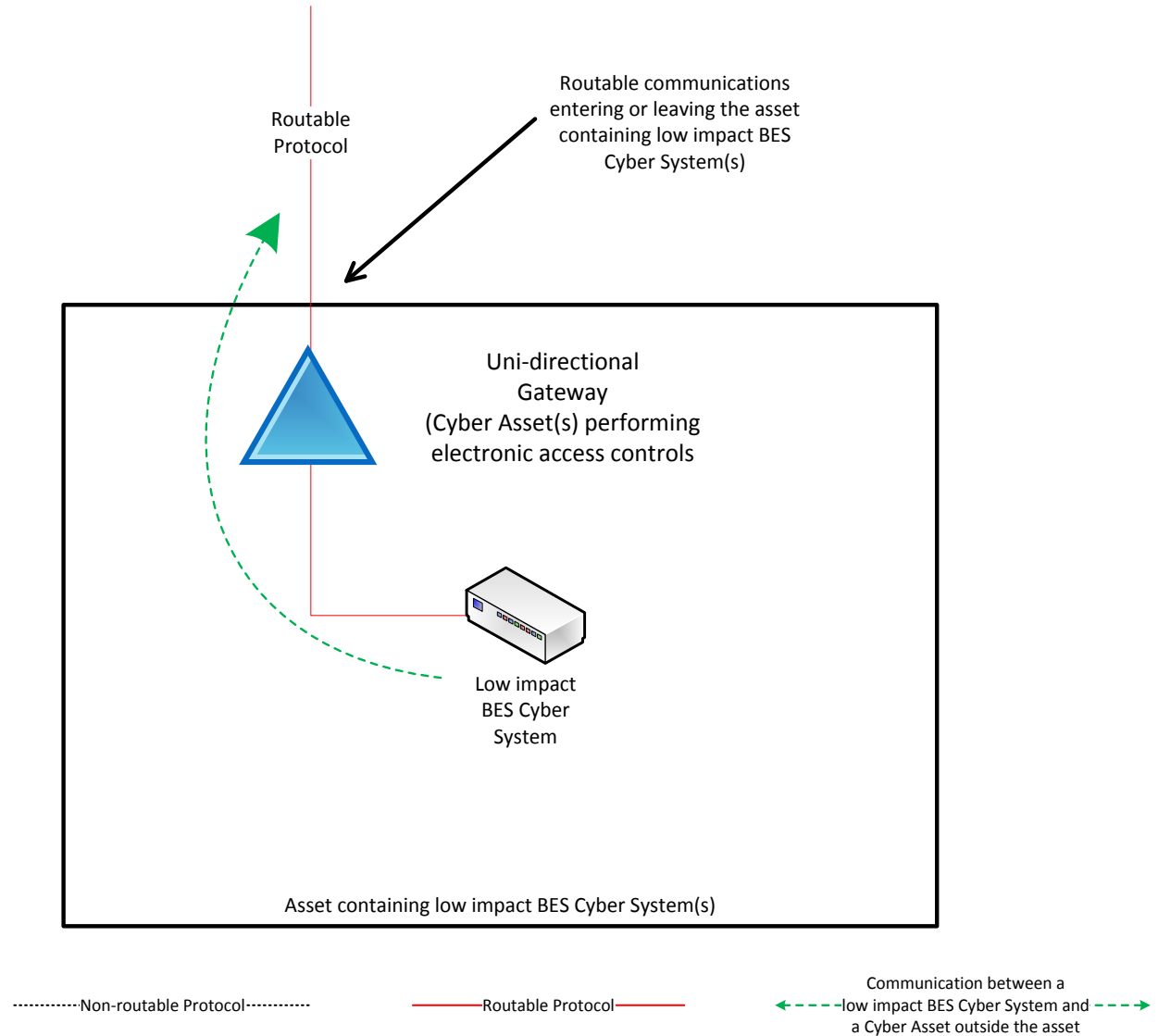

Reference Model 4

### Reference Model 5 – User Authentication

This reference model demonstrates that Responsible Entities have flexibility in choosing electronic access controls so long as the security objective of the requirement is met. The Responsible Entity may choose to utilize a non-BES Cyber Asset located at the asset containing the low impact BES Cyber System that requires authentication for communication from the Cyber Asset(s) outside the asset. This non-BES Cyber System performing the authentication permits only authenticated communication to connect to the low impact BES Cyber System(s), meeting the first half of the security objective to permit only necessary inbound electronic access. Additionally, the non-BES Cyber System performing authentication is configured such that it permits only necessary outbound communication meeting the second half of the security objective. Often, the outbound communications would be controlled in this network architecture by permitting no communication to be initiated from the low impact BES Cyber System. This configuration may be beneficial when the only communication to a device is for user-initiated interactive access.

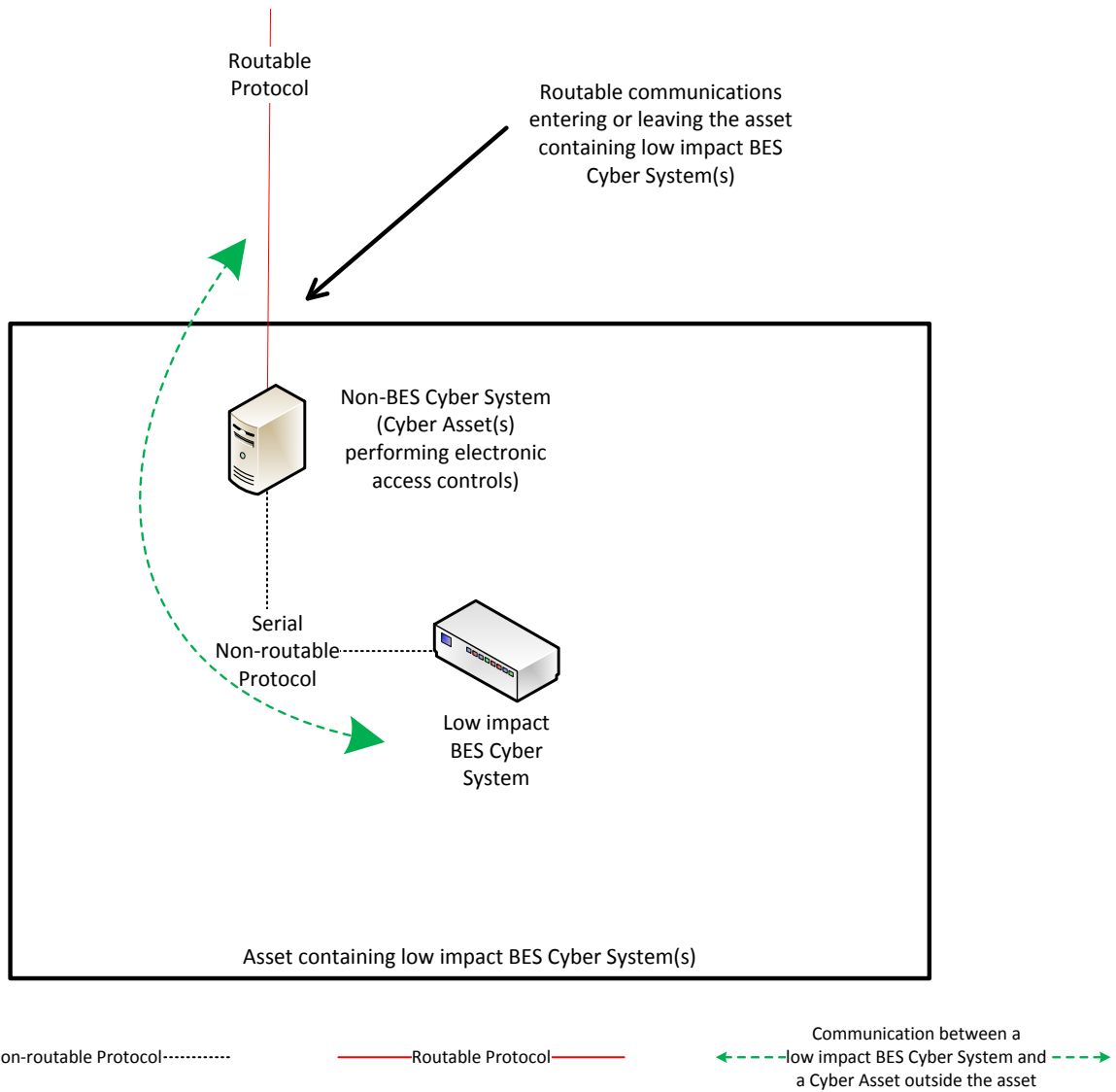

Reference Model 5

### Reference Model 6 – Indirect Access

In implementing its electronic access controls, the Responsible Entity may identify that it has indirect access between the low impact BES Cyber System and a Cyber Asset outside the asset containing the low impact BES Cyber System through a non-BES Cyber Asset located within the asset. This indirect access meets the criteria of having communication between the low impact BES Cyber System and a Cyber Asset outside the asset containing the low impact BES Cyber System. In this reference model, it is intended that the Responsible Entity implement electronic access controls that permit only necessary inbound and outbound electronic access to the low impact BES Cyber System. Consistent with the other reference models provided, the electronic access in this reference model is controlled using the security device that is restricting the communication that is entering or leaving the asset.

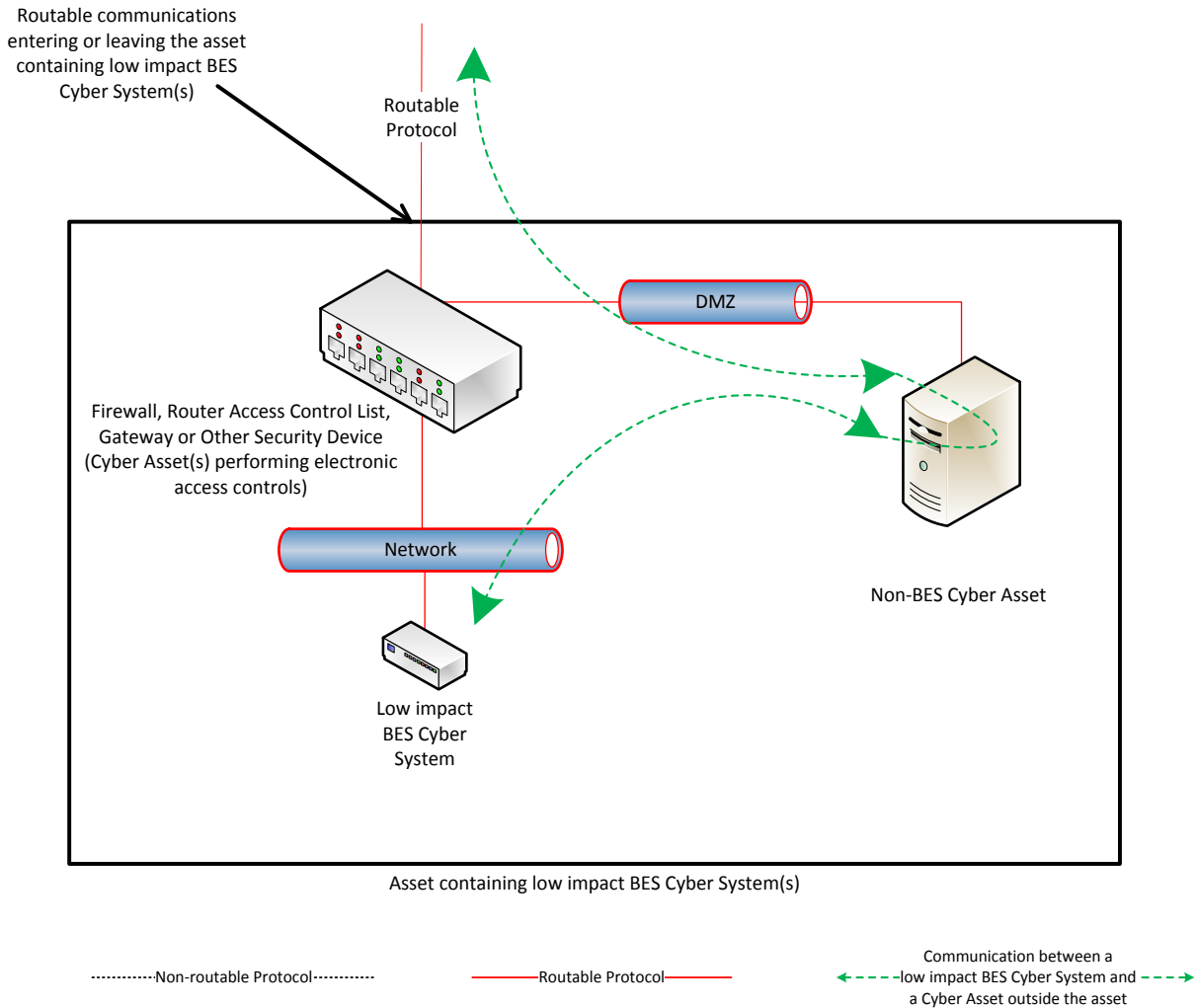

Reference Model 6

### Reference Model 7 – Electronic Access Controls at assets containing low impact BES Cyber Systems and ERC

In this reference model, there is both a routable protocol entering and leaving the asset containing the low impact BES Cyber System(s) that is used by Cyber Asset(s) outside the asset and External Routable Connectivity because there is at least one medium impact BES Cyber System and one low impact BES Cyber System within the asset using the routable protocol communications. The Responsible Entity may choose to leverage an interface on the medium impact Electronic Access Control or Monitoring Systems (EACMS) to provide electronic access controls for purposes of CIP-003. The EACMS is therefore performing multiple functions – as a medium impact EACMS and as implementing electronic access controls for an asset containing low impact BES Cyber Systems.

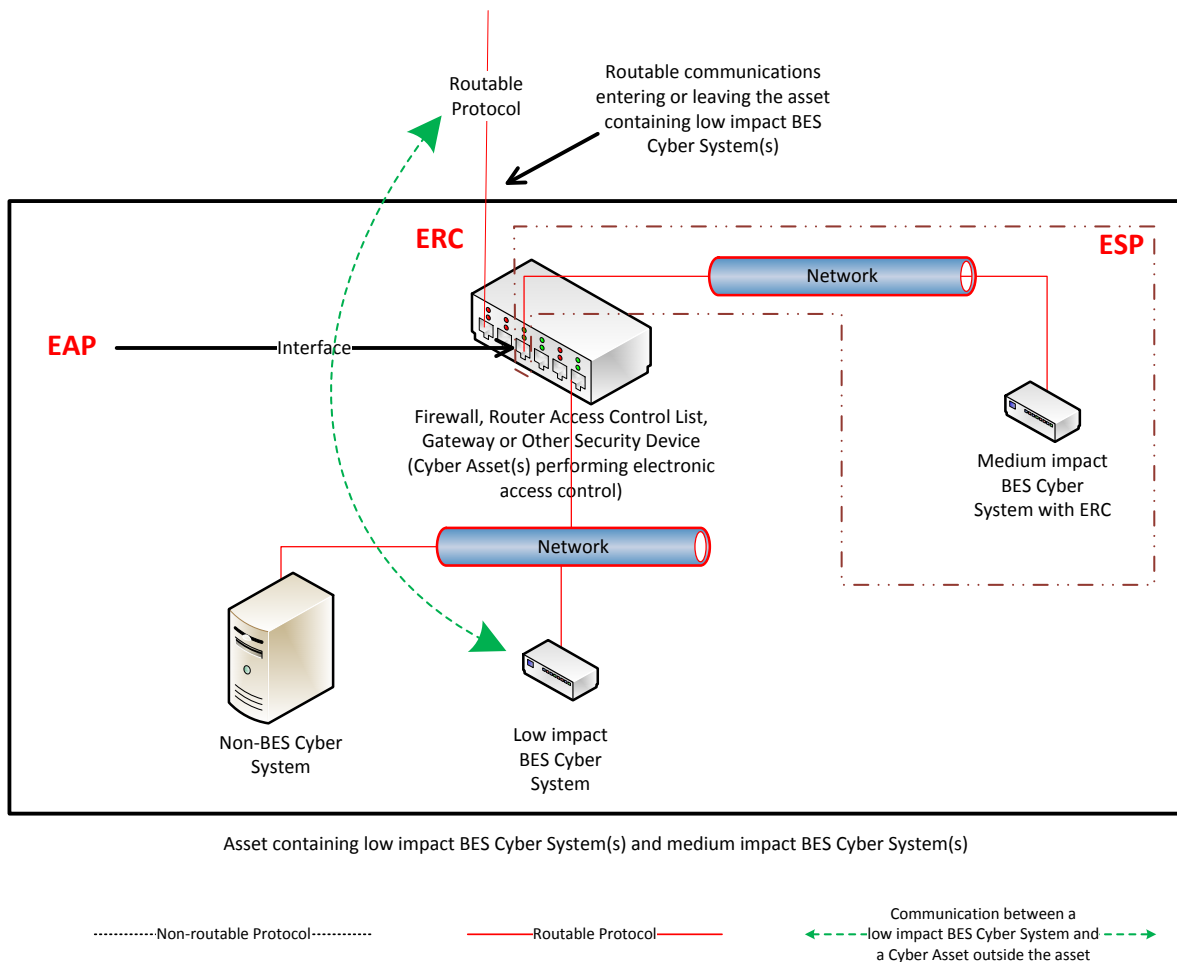

Reference Model 7

**Reference Model 8 – Physical Isolation and Serial Non-routable Communications – No Electronic Access Controls Required**

In this reference model, the criteria from Attachment 1, Section 3.1 requiring the implementation of electronic access controls are not met. This reference model demonstrates three concepts:

- 1) The physical isolation of the low impact BES Cyber System(s) from the routable protocol communication entering or leaving the asset containing the low impact BES Cyber System(s), commonly referred to as an 'air gap', mitigates the need to implement the required electronic access controls;
- 2) The communication to the low impact BES Cyber System from a Cyber Asset outside the asset containing the low impact BES Cyber System(s) using only a serial non-routable protocol where such communication is entering or leaving the asset mitigates the need to implement the required electronic access controls.
- 3) The routable protocol communication between the low impact BES Cyber System(s) and other Cyber Asset(s), such as the second low impact BES Cyber System depicted, may exist without needing to implement the required electronic access controls so long as the routable protocol communications never leaves the asset containing the low impact BES Cyber System(s).

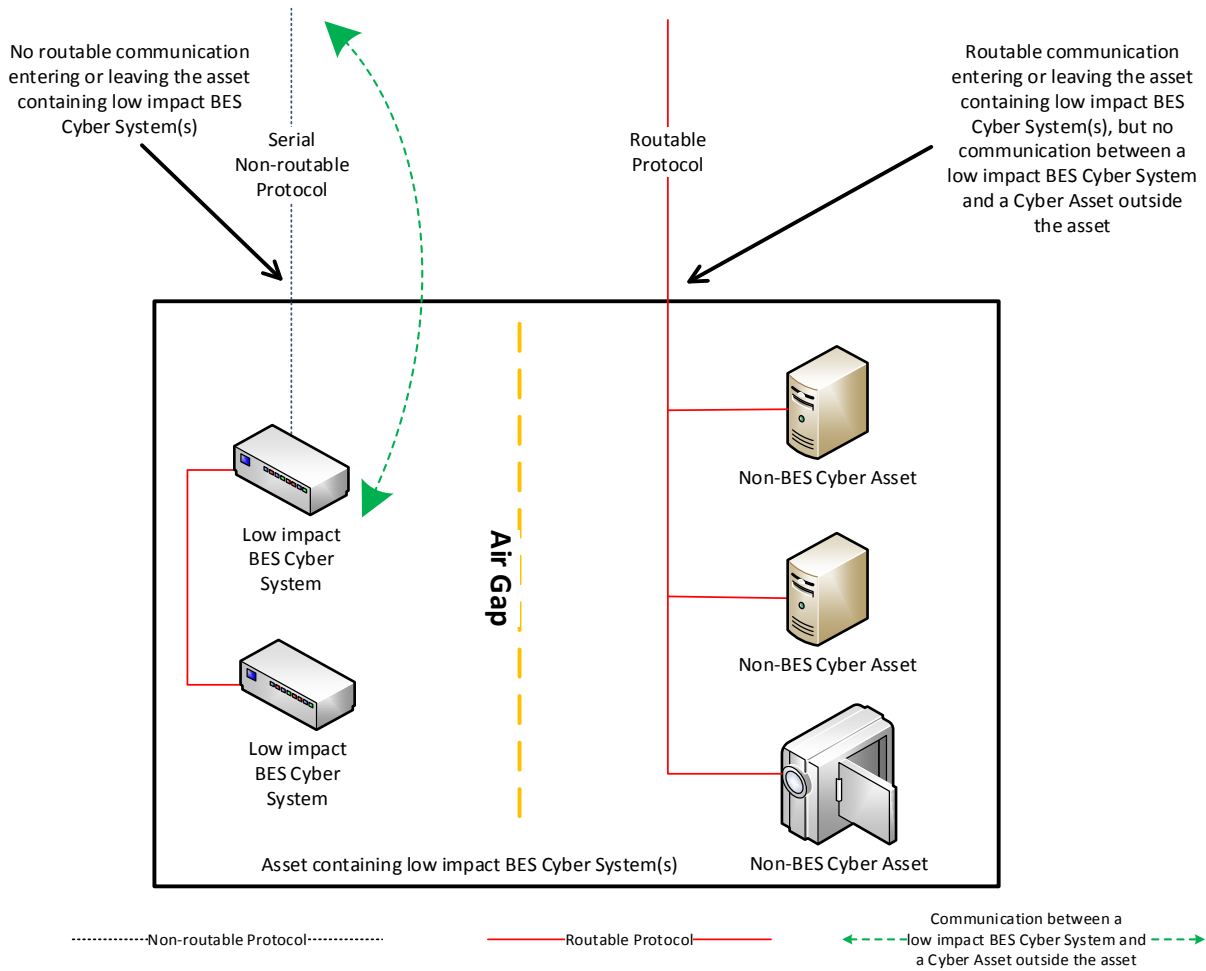

Reference Model 8



**Reference Model 9 – Logical Isolation - No Electronic Access Controls Required**

In this reference model, the criteria from Attachment 1, Section 3.1 requiring the implementation of electronic access controls are not met. The Responsible Entity has logically isolated the low impact BES Cyber System(s) from the routable protocol communication entering or leaving the asset containing low impact BES Cyber System(s). The logical network segmentation in this reference model permits no communication between a low impact BES Cyber System and a Cyber Asset outside the asset. Additionally, no indirect access exists because those non-BES Cyber Assets that are able to communicate outside the asset are strictly prohibited from communicating to the low impact BES Cyber System(s). The low impact BES Cyber System(s) is on an isolated network segment with logical controls preventing routable protocol communication into or out of the network containing the low impact BES Cyber System(s) and these communications never leave the asset using a routable protocol.

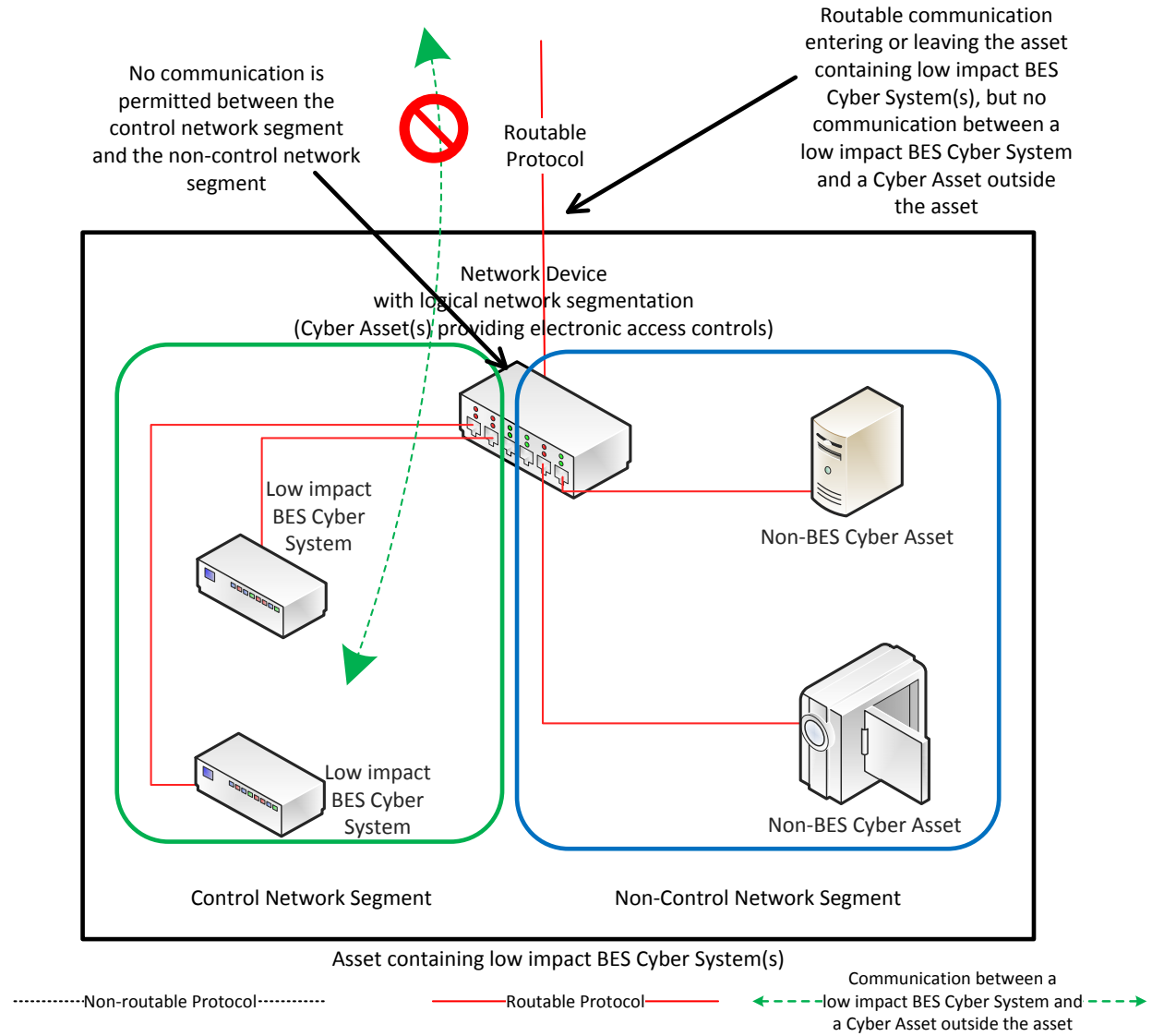

Reference Model 9

**Reference Model 10 - Serial Non-routable Communications Traversing an Isolated Channel on a Non-routable Transport Network – No Electronic Access Controls Required**

In this reference model, the criteria from Attachment 1, Section 3.1 requiring the implementation of electronic access controls are not met. This reference model depicts communication between a low impact BES Cyber System and a Cyber Asset outside the asset containing the low impact BES Cyber System over a serial non-routable protocol which is transported across a wide-area network using a protocol independent transport that may carry routable and non-routable communication such as a Time-Division Multiplexing (TDM) network, a Synchronous Optical Network (SONET), or a Multiprotocol Label Switching (MPLS) network. While there is routable protocol communication entering or leaving the asset containing low impact BES Cyber Systems(s) and there is communication between a low impact BES Cyber System and a Cyber Asset outside the asset, the communication between the low impact BES Cyber System and the Cyber Asset outside the asset is not using the routable protocol communication. This model is related to Reference Model 9 in that it relies on logical isolation to prohibit the communication between a low impact BES Cyber System and a Cyber Asset outside the asset from using a routable protocol.

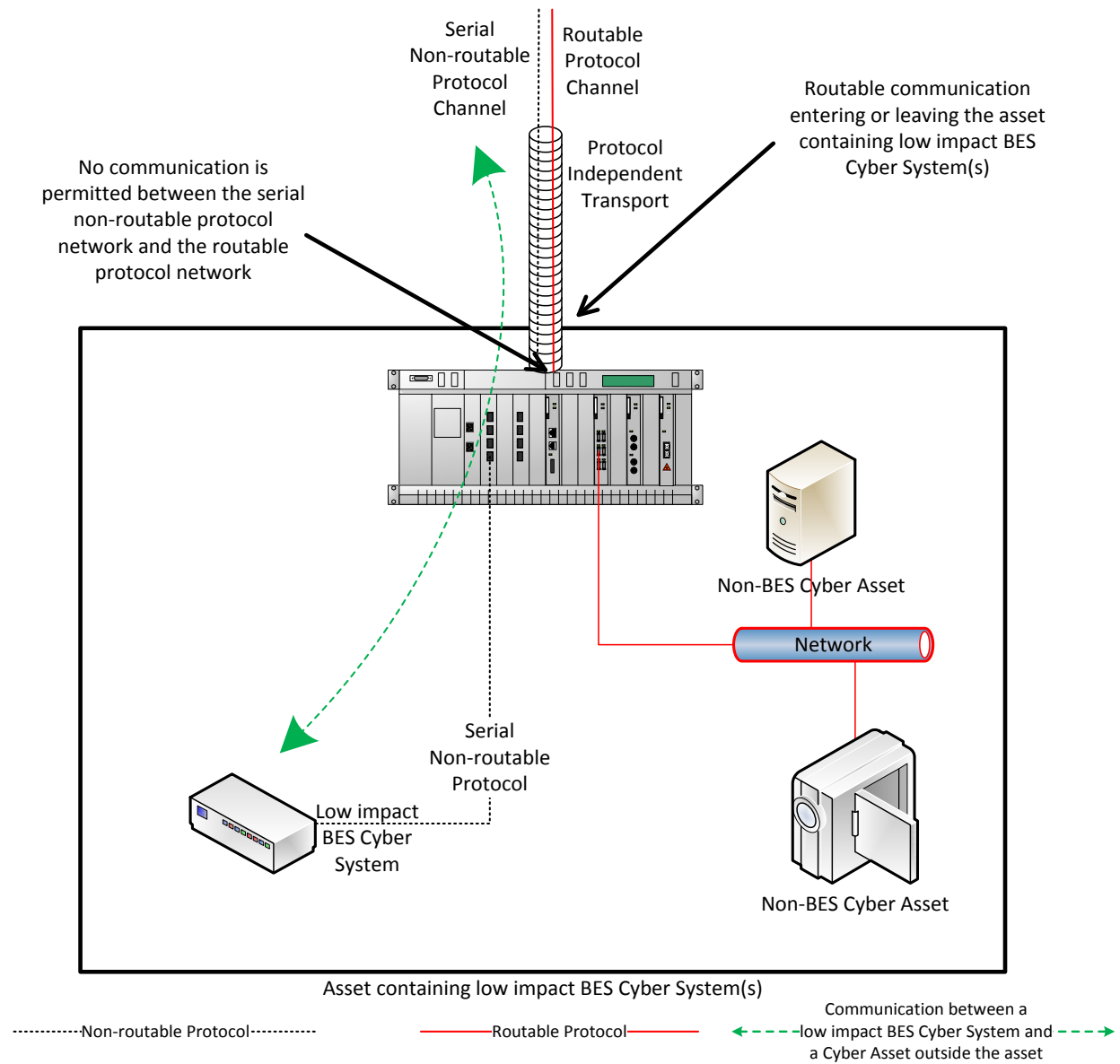

Reference Model 10

### Dial-up Connectivity

Dial-up Connectivity to a low impact BES Cyber System is set to dial out only (no auto-answer) to a preprogrammed number to deliver data. Incoming Dial-up Connectivity is to a dialback modem, a modem that must be remotely controlled by the control center or control room, has some form of access control, or the low impact BES Cyber System has access control.

### Insufficient Access Controls

Some examples of situations that would lack sufficient access controls to meet the intent of this requirement include:

- An asset has Dial-up Connectivity and a low impact BES Cyber System is reachable via an auto-answer modem that connects any caller to the Cyber Asset that has a default password. There is no practical access control in this instance.
- A low impact BES Cyber System has a wireless card on a public carrier that allows the BES Cyber System to be reachable via a public IP address. In essence, low impact BES Cyber Systems should not be accessible from the Internet and search engines such as Shodan.
- Dual-homing or multiple-network interface cards without disabling IP forwarding in the non-BES Cyber Asset within the DMZ to provide separation between the low impact BES Cyber System(s) and the external network would not meet the intent of “controlling” inbound and outbound electronic access assuming there was no other host-based firewall or other security devices on the non-BES Cyber Asset.

### Requirement R2, Attachment 1, Section 4 – Cyber Security Incident Response

The entity should have one or more documented Cyber Security Incident response plan(s) that include each of the topics listed in Section 4. If, in the normal course of business, suspicious activities are noted at an asset containing low impact BES Cyber System(s), the intent is for the entity to implement a Cyber Security Incident response plan that will guide the entity in responding to the incident and reporting the incident if it rises to the level of a Reportable Cyber Security Incident.

Entities are provided the flexibility to develop their Attachment 1, Section 4 Cyber Security Incident response plan(s) by asset or group of assets. The plans do not need to be on a per asset site or per low impact BES Cyber System basis. Entities can choose to use a single enterprise-wide plan to fulfill the obligations for low impact BES Cyber Systems.

The plan(s) must be tested once every 36 months. This is not an exercise per low impact BES Cyber Asset or per type of BES Cyber Asset but rather is an exercise of each incident response plan the entity created to meet this requirement. An actual Reportable Cyber Security Incident counts as an exercise as do other forms of tabletop exercises or drills. NERC-led exercises such as GridEx participation would also count as an exercise provided the entity’s response plan is followed. The intent of the requirement is for entities to keep the Cyber Security Incident response plan(s) current, which includes updating the plan(s), if needed, within 180 days following a test or an actual incident.

For low impact BES Cyber Systems, the only portion of the definition of Cyber Security Incident that would apply is, “A malicious act or suspicious event that disrupts, or was an attempt to

disrupt, the operation of a BES Cyber System.” The other portion of that definition is not to be used to require ESPs and PSPs for low impact BES Cyber Systems.

### **Requirement R2, Attachment 1, Section 5 – Transient Cyber Assets and Removable Media Malicious Code Risk Mitigation**

Most BES Cyber Assets and BES Cyber Systems are isolated from external public or untrusted networks, and therefore Transient Cyber Assets and Removable Media are needed to transport files to and from secure areas to maintain, monitor, or troubleshoot critical systems. Transient Cyber Assets and Removable Media are a potential means for cyber-attack. To protect the BES Cyber Assets and BES Cyber Systems, CIP-003 Requirement R2, Attachment 1, Section 5 requires Responsible Entities to document and implement a plan for how they will mitigate the risk of malicious code introduction to low impact BES Cyber Systems from Transient Cyber Assets and Removable Media. The approach of defining a plan allows the Responsible Entity to document processes that are supportable within its organization and in alignment with its change management processes.

Transient Cyber Assets can be one of many types of devices from a specially-designed device for maintaining equipment in support of the BES to a platform such as a laptop, desktop, or tablet that may interface with or run applications that support BES Cyber Systems and is capable of transmitting executable code to the BES Cyber Asset(s) or BES Cyber System(s). Note: Cyber Assets connected to a BES Cyber System for less than 30 days due to an unplanned removal, such as premature failure, are not intended to be identified as Transient Cyber Assets. Removable Media subject to this requirement include, among others, floppy disks, compact disks, USB flash drives, external hard drives, and other flash memory cards/drives that contain nonvolatile memory.

Examples of these temporarily connected devices include, but are not limited to:

- Diagnostic test equipment;
- Equipment used for BES Cyber System maintenance; or
- Equipment used for BES Cyber System configuration.

To meet the objective of mitigating risks associated with the introduction of malicious code at low impact BES Cyber Systems, Section 5 specifies the capabilities and possible security methods available to Responsible Entities based upon asset type and ownership.

With the list of options provided in Attachment 1, the entity has the discretion to use the option(s) that is most appropriate. This includes documenting its approach for how and when the entity reviews the Transient Cyber Asset under its control or under the control of parties other than the Responsible Entity. The entity should avoid implementing a security function that jeopardizes reliability by taking actions that would negatively impact the performance or support of the Transient Cyber Asset or BES Cyber Asset.

### Malicious Code Risk Mitigation

The terms “mitigate”, “mitigating”, and “mitigation” are used in Section 5 in Attachment 1 to address the risks posed by malicious code when connecting Transient Cyber Assets and Removable Media to BES Cyber Systems. Mitigation is intended to mean that entities reduce security risks presented by connecting the Transient Cyber Asset or Removable Media. When determining the method(s) to mitigate the introduction of malicious code, it is not intended for entities to perform and document a formal risk assessment associated with the introduction of malicious code.

### Per Transient Cyber Asset Capability

As with other CIP standards, the requirements are intended for an entity to use the method(s) that the system is capable of performing. The use of “per Transient Cyber Asset capability” is to eliminate the need for a Technical Feasibility Exception when it is understood that the device cannot use a method(s). For example, for malicious code, many types of appliances are not capable of implementing antivirus software; therefore, because it is not a capability of those types of devices, implementation of the antivirus software would not be required for those devices.

### **Requirement R2, Attachment 1, Section 5.1 - Transient Cyber Asset(s) Managed by the Responsible Entity**

For Transient Cyber Assets and Removable Media that are connected to both low impact and medium/high impact BES Cyber Systems, entities must be aware of the differing levels of requirements and manage these assets under the program that matches the highest impact level to which they will connect.

**Section 5.1:** Entities are to document and implement their plan(s) to mitigate malicious code through the use of one or more of the protective measures listed, based on the capability of the Transient Cyber Asset.

The Responsible Entity has the flexibility to apply the selected method(s) to meet the objective of mitigating the introductions of malicious code either in an on-going or in an on-demand manner. An example of managing a device in an on-going manner is having the antivirus solution for the device managed as part of an end-point security solution with current signature or pattern updates, regularly scheduled systems scans, etc. In contrast, for devices that are used infrequently and the signatures or patterns are not kept current, the entity may manage those devices in an on-demand manner by requiring an update to the signatures or patterns and a scan of the device before the device is connected to ensure that it is free of malicious code.

Selecting management in an on-going or on-demand manner is not intended to imply that the control has to be verified at every single connection. For example, if the device is managed in an on-demand manner, but will be used to perform maintenance on several BES Cyber Asset(s), the Responsible Entity may choose to document that the Transient Cyber Asset has been updated before being connected as a Transient Cyber Asset for the first use of that maintenance work. The intent is not to require a log documenting each connection of a Transient Cyber Asset to a BES Cyber Asset.

The following is additional discussion of the methods to mitigate the introduction of malicious code.

- Antivirus software, including manual or managed updates of signatures or patterns, provides flexibility to manage Transient Cyber Asset(s) by deploying antivirus or endpoint security tools that maintain a scheduled update of the signatures or patterns. Also, for devices that do not regularly connect to receive scheduled updates, entities may choose to update the signatures or patterns and scan the Transient Cyber Asset prior to connection to ensure no malicious software is present.
- Application whitelisting is a method of authorizing only the applications and processes that are necessary on the Transient Cyber Asset. This reduces the risk that malicious software could execute on the Transient Cyber Asset and impact the BES Cyber Asset or BES Cyber System.
- When using methods other than those listed, entities need to document how the other method(s) meet the objective of mitigating the risk of the introduction of malicious code.

If malicious code is discovered on the Transient Cyber Asset, it must be mitigated prior to connection to a BES Cyber System to prevent the malicious code from being introduced into the BES Cyber System. An entity may choose to not connect the Transient Cyber Asset to a BES Cyber System to prevent the malicious code from being introduced into the BES Cyber System. Entities should also consider whether the detected malicious code is a Cyber Security Incident.

### **Requirement R2, Attachment 1, Section 5.2 - Transient Cyber Asset(s) Managed by a Party Other than the Responsible Entity**

Section 5 also recognizes the lack of direct control over Transient Cyber Assets that are managed by parties other than the Responsible Entity. This lack of control, however, does not obviate the Responsible Entity's responsibility to ensure that methods have been deployed to mitigate the introduction of malicious code to low impact BES Cyber System(s) from Transient Cyber Assets it does not manage. Section 5 requires entities to review the other party's security practices with respect to Transient Cyber Assets to help meet the objective of the requirement. The use of "prior to connecting the Transient Cyber Assets" is intended to ensure that the Responsible Entity conducts the review before the first connection of the Transient Cyber Asset to help meet the objective to mitigate the introduction of malicious code. The SDT does not intend for the Responsible Entity to conduct a review for every single connection of that Transient Cyber Asset once the Responsible Entity has established the Transient Cyber Asset is meeting the security objective. The intent is to not require a log documenting each connection of a Transient Cyber Asset to a BES Cyber Asset.

To facilitate these controls, Responsible Entities may execute agreements with other parties to provide support services to BES Cyber Systems and BES Cyber Assets that may involve the use of Transient Cyber Assets. Entities may consider using the Department of Energy Cybersecurity Procurement Language for Energy Delivery dated April 2014.<sup>1</sup> Procurement language may unify

---

<sup>1</sup> <http://www.energy.gov/oe/downloads/cybersecurity-procurement-language-energy-delivery-april-2014>



the other party and entity actions supporting the BES Cyber Systems and BES Cyber Assets. CIP program attributes may be considered including roles and responsibilities, access controls, monitoring, logging, vulnerability, and patch management along with incident response and back up recovery may be part of the other party's support. Entities may consider the "General Cybersecurity Procurement Language" and "The Supplier's Life Cycle Security Program" when drafting Master Service Agreements, Contracts, and the CIP program processes and controls.

**Section 5.2.1:** Entities are to document and implement their process(es) to mitigate the introduction of malicious code through the use of one or more of the protective measures listed.

- Review the use of antivirus software and signature or pattern levels to ensure that the level is adequate to the Responsible Entity to mitigate the risk of malicious software being introduced to an applicable system.
- Review the antivirus or endpoint security processes of the other party to ensure that their processes are adequate to the Responsible Entity to mitigate the risk of introducing malicious software to an applicable system.
- Review the use of application whitelisting used by the other party to mitigate the risk of introducing malicious software to an applicable system.
- Review the use of live operating systems or software executable only from read-only media to ensure that the media is free from malicious software itself. Entities should review the processes to build the read-only media as well as the media itself.
- Review system hardening practices used by the other party to ensure that unnecessary ports, services, applications, etc. have been disabled or removed. This method intends to reduce the attack surface on the Transient Cyber Asset and reduce the avenues by which malicious software could be introduced.

**Section 5.2.2:** The intent of this section is to ensure that after conducting the selected review from Section 5.2.1, if there are deficiencies identified, actions mitigating the risk of the introduction of malicious code to low impact BES Cyber Systems must be completed prior to connecting the device(s) to an applicable system.

### **Requirement R2, Attachment 1, Section 5.3 - Removable Media**

Entities have a high level of control for Removable Media that are going to be connected to their BES Cyber Assets.

**Section 5.3:** Entities are to document and implement their process(es) to mitigate the introduction of malicious code through the use of one or more method(s) to detect malicious code on the Removable Media before it is connected to a BES Cyber Asset. When using the method(s) to detect malicious code, it is expected to occur from a system that is not part of the BES Cyber System to reduce the risk of propagating malicious code into the BES Cyber System

network or onto one of the BES Cyber Assets. If malicious code is discovered, it must be removed or mitigated to prevent it from being introduced into the BES Cyber Asset or BES Cyber System. Entities should also consider whether the detected malicious code is a Cyber Security Incident. Frequency and timing of the methods used to detect malicious code were intentionally excluded from the requirement because there are multiple timing scenarios that can be incorporated into a plan to mitigate the risk of malicious code. The SDT does not intend to obligate a Responsible Entity to conduct a review for every single connection of Removable Media, but rather to implement its plan(s) in a manner that protects all BES Cyber Systems where Removable Media may be used. The intent is to not require a log documenting each connection of Removable Media to a BES Cyber Asset.

As a method to detect malicious code, entities may choose to use Removable Media with on-board malicious code detection tools. For these tools, the Removable Media are still used in conjunction with a Cyber Asset to perform the detection. For Section 5.3.1, the Cyber Asset used to perform the malicious code detection must be outside of the BES Cyber System.

### **Requirement R3:**

The intent of CIP-003-8, Requirement R3 is effectively unchanged since prior versions of the standard. The specific description of the CIP Senior Manager has now been included as a defined term rather than clarified in the Reliability Standard itself to prevent any unnecessary cross-reference to this standard. It is expected that the CIP Senior Manager will play a key role in ensuring proper strategic planning, executive/board-level awareness, and overall program governance.

### **Requirement R4:**

As indicated in the rationale for CIP-003-8, Requirement R4, this requirement is intended to demonstrate a clear line of authority and ownership for security matters. The intent of the SDT was not to impose any particular organizational structure, but, rather, the intent is to afford the Responsible Entity significant flexibility to adapt this requirement to its existing organizational structure. A Responsible Entity may satisfy this requirement through a single delegation document or through multiple delegation documents. The Responsible Entity can make use of the delegation of the delegation authority itself to increase the flexibility in how this applies to its organization. In such a case, delegations may exist in numerous documentation records as long as the collection of these documentation records shows a clear line of authority back to the CIP Senior Manager. In addition, the CIP Senior Manager could also choose not to delegate any authority and meet this requirement without such delegation documentation.

The Responsible Entity must keep its documentation of the CIP Senior Manager and any delegations up-to-date. This is to ensure that individuals do not assume any undocumented authority. However, delegations do not have to be re-instated if the individual who delegated the task changes roles or the individual is replaced. For instance, assume that John Doe is named the CIP Senior Manager and he delegates a specific task to the Substation Maintenance Manager. If John Doe is replaced as the CIP Senior Manager, the CIP Senior Manager documentation must be updated within the specified timeframe, but the existing delegation to

the Substation Maintenance Manager remains in effect as approved by the previous CIP Senior Manager, John Doe.

### **Rationale:**

During development of this standard, text boxes were embedded within the standard to explain the rationale for various parts of the standard. Upon BOT approval, the text from the rationale text boxes was moved to this section.

### **Rationale for Requirement R1:**

One or more security policies enable effective implementation of the requirements of the cyber security Reliability Standards. The purpose of policies is to provide a management and governance foundation for all requirements that apply to a Responsible Entity's BES Cyber Systems. The Responsible Entity can demonstrate through its policies that its management supports the accountability and responsibility necessary for effective implementation of the requirements.

Annual review and approval of the cyber security policies ensures that the policies are kept-up-to-date and periodically reaffirms management's commitment to the protection of its BES Cyber Systems.

### **Rationale for Requirement R2:**

In response to FERC Order No. 791, Requirement R2 requires entities to develop and implement cyber security plans to meet specific security control objectives for assets containing low impact BES Cyber System(s). The cyber security plan(s) covers five subject matter areas: (1) cyber security awareness; (2) physical security controls; (3) electronic access controls; (4) Cyber Security Incident response; and (5) Transient Cyber Asset and Removable Media Malicious Code Risk Mitigation. This plan(s), along with the cyber security policies required under Requirement R1, Part 1.2, provides a framework for operational, procedural, and technical safeguards for low impact BES Cyber Systems.

Considering the varied types of low impact BES Cyber Systems across the BES, Attachment 1 provides Responsible Entities flexibility on how to apply the security controls to meet the security objectives. Additionally, because many Responsible Entities have multiple-impact rated BES Cyber Systems, nothing in the requirement prohibits entities from using their high and medium impact BES Cyber System policies, procedures, and processes to implement security controls required for low impact BES Cyber Systems, as detailed in Requirement R2, Attachment 1.

Responsible Entities will use their identified assets containing low impact BES Cyber System(s) (developed pursuant to CIP-002) to substantiate the sites or locations associated with low impact BES Cyber System(s). However, there is no requirement or compliance expectation for Responsible Entities to maintain a list(s) of individual low impact BES Cyber System(s) and their associated cyber assets or to maintain a list of authorized users.

### **Rationale for Modifications to Sections 2 and 3 of Attachment 1 (Requirement R2):**

Requirement R2 mandates that entities develop and implement one or more cyber security plan(s) to meet specific security objectives for assets containing low impact BES Cyber System(s). In Paragraph 73 of FERC Order No. 822, the Commission directed NERC to modify "...the Low Impact External Routable Connectivity definition to reflect the commentary in the Guidelines and Technical Basis section of CIP-003-6...to provide needed clarity to the definition

and eliminate ambiguity surrounding the term ‘direct’ as it is used in the proposed definition...within one year of the effective date of this Final Rule.”

The revisions to Section 3 incorporate select language from the LERC definition into Attachment 1 and focus the requirement on implementing electronic access controls for asset(s) containing low impact BES Cyber System(s). This change requires the Responsible Entity to permit only necessary inbound and outbound electronic access when using a routable protocol entering or leaving the asset between low impact BES Cyber System(s) and a Cyber Asset(s) outside the asset containing low impact BES Cyber system(s). When this communication is present, Responsible Entities are required to implement electronic access controls unless that communication meets the following exclusion language (previously in the definition of LERC) contained in romanette (iii): “not used for time-sensitive protection or control functions between intelligent electronic devices (e.g. communications using protocol IEC TR-61850-90-5 R-GOOSE)”.

The revisions to Section 2 of Attachment 1 complement the revisions to Section 3; consequently, the requirement now mandates the Responsible Entity control physical access to “the Cyber Asset(s), as specified by the Responsible Entity, that provide electronic access control(s) implemented for Section 3.1, if any.” The focus on electronic access controls rather than on the Low Impact BES Cyber System Electronic Access Points (LEAPs) eliminates the need for LEAPs.

Given these revisions to Sections 2 and 3, the NERC Glossary terms: Low Impact External Routable Connectivity (LERC) and Low Impact BES Cyber System Electronic Access Point (LEAP) will be retired.

### **Rationale for Section 5 of Attachment 1 (Requirement R2):**

Requirement R2 mandates that entities develop and implement one or more cyber security plan(s) to meet specific security objectives for assets containing low impact BES Cyber System(s). In Paragraph 32 of FERC Order No. 822, the Commission directed NERC to “...provide mandatory protection for transient devices used at Low Impact BES Cyber Systems based on the risk posed to bulk electric system reliability.” Transient devices are potential vehicles for introducing malicious code into low impact BES Cyber Systems. Section 5 of Attachment 1 is intended to mitigate the risk of malware propagation to the BES through low impact BES Cyber Systems by requiring entities to develop and implement one or more plan(s) to address the risk. The cyber security plan(s) along with the cyber security policies required under Requirement R1, Part 1.2, provide a framework for operational, procedural, and technical safeguards for low impact BES Cyber Systems.

### **Rationale for Requirement R3:**

The identification and documentation of the single CIP Senior Manager ensures that there is clear authority and ownership for the CIP program within an organization, as called for in Blackout Report Recommendation 43. The language that identifies CIP Senior Manager responsibilities is included in the Glossary of Terms used in NERC Reliability Standards so that it may be used across the body of CIP standards without an explicit cross-reference.

FERC Order No. 706, Paragraph 296, requests consideration of whether the single senior manager should be a corporate officer or equivalent. As implicated through the defined term, the senior manager has “the overall authority and responsibility for leading and managing implementation of the requirements within this set of standards” which ensures that the senior manager is of sufficient position in the Responsible Entity to ensure that cyber security receives the prominence that is necessary. In addition, given the range of business models for responsible entities, from municipal, cooperative, federal agencies, investor owned utilities, privately owned utilities, and everything in between, the SDT believes that requiring the CIP Senior Manager to be a “corporate officer or equivalent” would be extremely difficult to interpret and enforce on a consistent basis.

### **Rationale for Requirement R4:**

The intent of the requirement is to ensure clear accountability within an organization for certain security matters. It also ensures that delegations are kept up-to-date and that individuals do not assume undocumented authority.

In FERC Order No. 706, Paragraphs 379 and 381, the Commission notes that Recommendation 43 of the 2003 Blackout Report calls for “clear lines of authority and ownership for security matters.” With this in mind, the Standard Drafting Team has sought to provide clarity in the requirement for delegations so that this line of authority is clear and apparent from the documented delegations.

## Standard Development Timeline

This section is maintained by the drafting team during the development of the standard and will be removed when the standard is adopted by the NERC Board of Trustees (Board).

### Description of Current Draft

45-day initial formal comment period with ballot.

Completed Actions	Date
Standards Committee approved Standard Authorization Request (SAR) for posting	June 13, 2018
SAR posted for comment	June 13 – July 13, 2018

Anticipated Actions	Date
45-day formal comment period with ballot (initial)	August 23 – October 8, 2018
10-day final ballot	October 29 – November 8, 2018
Board adoption	February 2019

## A. Introduction

1. **Title:** Cyber Security — Security Management Controls
2. **Number:** CIP-003-~~87~~
3. **Purpose:** To specify consistent and sustainable security management controls that establish responsibility and accountability to protect BES Cyber Systems against compromise that could lead to misoperation or instability in the Bulk Electric System (BES).

### 4. Applicability:

**4.1. Functional Entities:** For the purpose of the requirements contained herein, the following list of functional entities will be collectively referred to as “Responsible Entities.” For requirements in this standard where a specific functional entity or subset of functional entities are the applicable entity or entities, the functional entity or entities are specified explicitly.

#### 4.1.1. Balancing Authority

**4.1.2. Distribution Provider** that owns one or more of the following Facilities, systems, and equipment for the protection or restoration of the BES:

**4.1.2.1.** Each underfrequency Load shedding (UFLS) or undervoltage Load shedding (UVLS) system that:

**4.1.2.1.1.** is part of a Load shedding program that is subject to one or more requirements in a NERC or Regional Reliability Standard; and

**4.1.2.1.2.** performs automatic Load shedding under a common control system owned by the Responsible Entity, without human operator initiation, of 300 MW or more.

**4.1.2.2.** Each ~~Special Protection System (SPS) or~~ Remedial Action Scheme (RAS) where the ~~SPS or~~ RAS is subject to one or more requirements in a NERC or Regional Reliability Standard.

**4.1.2.3.** Each Protection System (excluding UFLS and UVLS) that applies to Transmission where the Protection System is subject to one or more requirements in a NERC or Regional Reliability Standard.

**4.1.2.4.** Each Cranking Path and group of Elements meeting the initial switching requirements from a Blackstart Resource up to and including the first interconnection point of the starting station service of the next generation unit(s) to be started.

#### 4.1.3. Generator Operator

#### 4.1.4. Generator Owner

#### ~~4.1.5. Interchange Coordinator or Interchange Authority~~



~~4.1.6.4.1.5.~~ **Reliability Coordinator**

~~4.1.7.4.1.6.~~ **Transmission Operator**

~~4.1.8.4.1.7.~~ **Transmission Owner**

**4.2. Facilities:** For the purpose of the requirements contained herein, the following Facilities, systems, and equipment owned by each Responsible Entity in Section 4.1 above are those to which these requirements are applicable. For requirements in this standard where a specific type of Facilities, system, or equipment or subset of Facilities, systems, and equipment are applicable, these are specified explicitly.

**4.2.1. Distribution Provider:** One or more of the following Facilities, systems and equipment owned by the Distribution Provider for the protection or restoration of the BES:

**4.2.1.1.** Each UFLS or UVLS System that:

**4.2.1.1.1.** is part of a Load shedding program that is subject to one or more requirements in a NERC or Regional Reliability Standard; and

**4.2.1.1.2.** performs automatic Load shedding under a common control system owned by the Responsible Entity, without human operator initiation, of 300 MW or more.

**4.2.1.2.** Each ~~SPS or~~ RAS where the ~~SPS or~~ RAS is subject to one or more requirements in a NERC or Regional Reliability Standard.

**4.2.1.3.** Each Protection System (excluding UFLS and UVLS) that applies to Transmission where the Protection System is subject to one or more requirements in a NERC or Regional Reliability Standard.

**4.2.1.4.** Each Cranking Path and group of Elements meeting the initial switching requirements from a Blackstart Resource up to and including the first interconnection point of the starting station service of the next generation unit(s) to be started.

**4.2.2. Responsible Entities listed in 4.1 other than Distribution Providers:**

All BES Facilities.

**4.2.3. Exemptions:** The following are exempt from Standard CIP-003-~~87~~:

**4.2.3.1.** Cyber Assets at Facilities regulated by the Canadian Nuclear Safety Commission.

**4.2.3.2.** Cyber Assets associated with communication networks and data communication links between discrete Electronic Security Perimeters (ESPs).

**4.2.3.3.** The systems, structures, and components that are regulated by the Nuclear Regulatory Commission under a cyber security plan pursuant to 10 C.F.R. Section 73.54.

**4.2.3.4.** For Distribution Providers, the systems and equipment that are not included in section 4.2.1 above.

## 5. Effective Dates:

See Implementation Plan for CIP-003-78.

**5.1. Planned and Unplanned Changes:** For any Planned Change or Unplanned Change, as those terms are defined in the Effective Dates Section of Reliability Standard CIP-002, the Responsible Entity must comply with the requirements in this Reliability Standard on the date the Responsible Entity must comply with the requirements in Reliability Standard CIP-002 following a Planned Change or Unplanned Change.

## 6. Background:

Standard CIP-003 exists as part of a suite of CIP Standards related to cyber security, which require the initial identification and categorization of BES Cyber Systems and require organizational, operational, and procedural controls to mitigate risk to BES Cyber Systems.

The term policy refers to one or a collection of written documents that are used to communicate the Responsible Entities' management goals, objectives and expectations for how the Responsible Entity will protect its BES Cyber Systems. The use of policies also establishes an overall governance foundation for creating a culture of security and compliance with laws, regulations, and standards.

The term documented processes refers to a set of required instructions specific to the Responsible Entity and to achieve a specific outcome. This term does not imply any naming or approval structure beyond what is stated in the requirements. An entity should include as much as it believes necessary in its documented processes, but it must address the applicable requirements.

The terms program and plan are sometimes used in place of documented processes where it makes sense and is commonly understood. For example, documented processes describing a response are typically referred to as plans (i.e., incident response plans and recovery plans). Likewise, a security plan can describe an approach involving multiple procedures to address a broad subject matter.

Similarly, the term program may refer to the organization's overall implementation of its policies, plans, and procedures involving a subject matter. Examples in the standards include the personnel risk assessment program and the personnel training program. The full implementation of the CIP Cyber Security Reliability Standards could also be referred to as a program. However, the terms program and plan do not imply any additional requirements beyond what is stated in the standards.

Responsible Entities can implement common controls that meet requirements for multiple high, medium, and low impact BES Cyber Systems. For example, a single cyber security awareness program could meet the requirements across multiple BES Cyber Systems.

Measures provide examples of evidence to show documentation and implementation of the requirement. These measures serve to provide guidance to entities in acceptable records of compliance and should not be viewed as an all-inclusive list.

Throughout the standards, unless otherwise stated, bulleted items in the requirements and measures are items that are linked with an “or,” and numbered items are items that are linked with an “and.”

Many references in the Applicability section use a threshold of 300 MW for UFLS and UVLS. This particular threshold of 300 MW for UVLS and UFLS was provided in Version 1 of the CIP Cyber Security Standards. The threshold remains at 300 MW since it is specifically addressing UVLS and UFLS, which are last ditch efforts to save the BES. A review of UFLS tolerances defined within Regional Reliability Standards for UFLS program requirements to date indicates that the historical value of 300 MW represents an adequate and reasonable threshold value for allowable UFLS operational tolerances.

## B. Requirements and Measures

- R1.** Each Responsible Entity shall review and obtain CIP Senior Manager approval at least once every 15 calendar months for one or more documented cyber security policies that collectively address the following topics: *[Violation Risk Factor: Medium] [Time Horizon: Operations Planning]*
- 1.1.** For its high impact and medium impact BES Cyber Systems, if any:
    - 1.1.1.** Personnel and training (CIP-004);
    - 1.1.2.** Electronic Security Perimeters (CIP-005) including Interactive Remote Access;
    - 1.1.3.** Physical security of BES Cyber Systems (CIP-006);
    - 1.1.4.** System security management (CIP-007);
    - 1.1.5.** Incident reporting and response planning (CIP-008);
    - 1.1.6.** Recovery plans for BES Cyber Systems (CIP-009);
    - 1.1.7.** Configuration change management and vulnerability assessments (CIP-010);
    - 1.1.8.** Information protection (CIP-011); and
    - 1.1.9.** Declaring and responding to CIP Exceptional Circumstances.
  - 1.2.** For its assets identified in CIP-002 containing low impact BES Cyber Systems, if any:
    - 1.2.1.** Cyber security awareness;
    - 1.2.2.** Physical security controls;
    - 1.2.3.** Electronic access controls;
    - 1.2.4.** Cyber Security Incident response;
    - 1.2.5.** Transient Cyber Assets and Removable Media malicious code risk mitigation; and
    - 1.2.6.** Declaring and responding to CIP Exceptional Circumstances.
- M1.** Examples of evidence may include, but are not limited to, policy documents; revision history, records of review, or workflow evidence from a document management system that indicate review of each cyber security policy at least once every 15 calendar months; and documented approval by the CIP Senior Manager for each cyber security policy.
- R2.** Each Responsible Entity with at least one asset identified in CIP-002 containing low impact BES Cyber Systems shall implement one or more documented cyber security plan(s) for its low impact BES Cyber Systems that include the sections in Attachment 1. *[Violation Risk Factor: Lower] [Time Horizon: Operations Planning]*

Note: An inventory, list, or discrete identification of low impact BES Cyber Systems or their BES Cyber Assets is not required. Lists of authorized users are not required.

- M2.** Evidence shall include each of the documented cyber security plan(s) that collectively include each of the sections in Attachment 1 and additional evidence to demonstrate implementation of the cyber security plan(s). Additional examples of evidence per section are located in Attachment 2.
- R3.** Each Responsible Entity shall identify a CIP Senior Manager by name and document any change within 30 calendar days of the change. *[Violation Risk Factor: Medium]*  
*[Time Horizon: Operations Planning]*
- M3.** An example of evidence may include, but is not limited to, a dated and approved document from a high level official designating the name of the individual identified as the CIP Senior Manager.
- R4.** The Responsible Entity shall implement a documented process to delegate authority, unless no delegations are used. Where allowed by the CIP Standards, the CIP Senior Manager may delegate authority for specific actions to a delegate or delegates. These delegations shall be documented, including the name or title of the delegate, the specific actions delegated, and the date of the delegation; approved by the CIP Senior Manager; and updated within 30 days of any change to the delegation. Delegation changes do not need to be reinstated with a change to the delegator. *[Violation Risk Factor: Lower]* *[Time Horizon: Operations Planning]*
- M4.** An example of evidence may include, but is not limited to, a dated document, approved by the CIP Senior Manager, listing individuals (by name or title) who are delegated the authority to approve or authorize specifically identified items.

## C. Compliance

### 1. Compliance Monitoring Process

#### 1.1. Compliance Enforcement Authority:

As defined in the NERC Rules of Procedure, “Compliance Enforcement Authority” (CEA) means NERC or the Regional Entity in their respective roles of monitoring and enforcing compliance with the NERC Reliability Standards.

#### 1.2. Evidence Retention:

The following evidence retention periods identify the period of time an entity is required to retain specific evidence to demonstrate compliance. For instances where the evidence retention period specified below is shorter than the time since the last audit, the CEA may ask an entity to provide other evidence to show that it was compliant for the full time period since the last audit.

The Responsible Entity shall keep data or evidence to show compliance as identified below unless directed by its CEA to retain specific evidence for a longer period of time as part of an investigation:

- Each Responsible Entity shall retain evidence of each requirement in this standard for three calendar years.
- If a Responsible Entity is found non-compliant, it shall keep information related to the non-compliance until mitigation is complete and approved or for the time specified above, whichever is longer.
- The CEA shall keep the last audit records and all requested and submitted subsequent audit records.

#### 1.3. Compliance Monitoring and Assessment Processes:

- Compliance Audits
- Self-Certifications
- Spot Checking
- Compliance Investigations
- Self-Reporting
- Complaints

#### 1.4. Additional Compliance Information:

None.

**Violation Severity Levels Table of Compliance Elements**

R #	Time Horizon	VRF	Violation Severity Levels (CIP-003-87)			
			Lower VSL	Moderate VSL	High VSL	Severe VSL
<b>R1</b>	<b>Operations Planning</b>	<b>Medium</b>	<p>The Responsible Entity documented and implemented one or more cyber security policies for its high impact and medium impact BES Cyber Systems, but did not address one of the nine topics required by R1. (R1.1)</p> <p>OR</p> <p>The Responsible Entity did not complete its review of the one or more documented cyber security policies for its high impact and medium impact BES Cyber Systems as required by R1 within 15 calendar months but did</p>	<p>The Responsible Entity documented and implemented one or more cyber security policies for its high impact and medium impact BES Cyber Systems, but did not address two of the nine topics required by R1. (R1.1)</p> <p>OR</p> <p>The Responsible Entity did not complete its review of the one or more documented cyber security policies for its high impact and medium impact BES Cyber Systems as required by R1 within 16 calendar months but did</p>	<p>The Responsible Entity documented and implemented one or more cyber security policies for its high impact and medium impact BES Cyber Systems, but did not address three of the nine topics required by R1. (R1.1)</p> <p>OR</p> <p>The Responsible Entity did not complete its review of the one or more documented cyber security policies for its high impact and medium impact BES Cyber Systems as required by R1 within 17 calendar months but did complete this review in less than or equal to 18</p>	<p>The Responsible Entity documented and implemented one or more cyber security policies for its high impact and medium impact BES Cyber Systems, but did not address four or more of the nine topics required by R1. (R1.1)</p> <p>OR</p> <p>The Responsible Entity did not have any documented cyber security policies for its high impact and medium impact BES Cyber Systems as required by R1. (R1.1)</p> <p>OR</p> <p>The Responsible Entity did not</p>

R #	Time Horizon	VRF	Violation Severity Levels (CIP-003-87)			
			Lower VSL	Moderate VSL	High VSL	Severe VSL
			complete this review in less than or equal to 16 calendar months of the previous review. (R1.1) OR The Responsible Entity did not complete its approval of the one or more documented cyber security policies for its high impact and medium impact BES Cyber Systems as required by R1 by the CIP Senior Manager within 15 calendar months but did complete this approval in less than or equal to 16 calendar months of the previous approval. (R1.1)	complete this review in less than or equal to 17 calendar months of the previous review. (R1.1) OR The Responsible Entity did not complete its approval of the one or more documented cyber security policies for its high impact and medium impact BES Cyber Systems as required by R1 by the CIP Senior Manager within 16 calendar months but did complete this approval in less than or equal to 17 calendar months of the previous approval. (R1.1)	calendar months of the previous review. (R1.1) OR The Responsible Entity did not complete its approval of the one or more documented cyber security policies for its high impact and medium impact BES Cyber Systems as required by R1 by the CIP Senior Manager within 17 calendar months but did complete this approval in less than or equal to 18 calendar months of the previous approval. (R1) OR The Responsible Entity documented one or more cyber security policies for its assets identified in CIP-002 containing low impact	complete its review of the one or more documented cyber security policies as required by R1 within 18 calendar months of the previous review. (R1) OR The Responsible Entity did not complete its approval of the one or more documented cyber security policies for its high impact and medium impact BES Cyber Systems as required by R1 by the CIP Senior Manager within 18 calendar months of the previous approval. (R1.1) OR



R #	Time Horizon	VRF	Violation Severity Levels (CIP-003-87)			
			Lower VSL	Moderate VSL	High VSL	Severe VSL
			<p>OR</p> <p>The Responsible Entity documented one or more cyber security policies for its assets identified in CIP-002 containing low impact BES Cyber Systems, but did not address one of the six topics required by R1. (R1.2)</p> <p>OR</p> <p>The Responsible Entity did not complete its review of the one or more documented cyber security policies for its assets identified in CIP-002 containing low impact BES Cyber Systems as required by Requirement R1 within 15 calendar</p>	<p>OR</p> <p>The Responsible Entity documented one or more cyber security policies for its assets identified in CIP-002 containing low impact BES Cyber Systems, but did not address two of the six topics required by R1. (R1.2)</p> <p>OR</p> <p>The Responsible Entity did not complete its review of the one or more documented cyber security policies for its assets identified in CIP-002 containing low impact BES Cyber Systems as required by Requirement R1 within 16 calendar</p>	<p>BES Cyber Systems, but did not address three of the six topics required by R1. (R1.2)</p> <p>OR</p> <p>The Responsible Entity did not complete its review of the one or more documented cyber security policies for its assets identified in CIP-002 containing low impact BES Cyber Systems as required by R1 within 17 calendar months but did not complete this review in less than or equal to 18 calendar months of the previous review. (R1.2)</p> <p>OR</p> <p>The Responsible Entity did not complete its approval of the one or more documented cyber security policies for its</p>	<p>The Responsible Entity documented one or more cyber security policies for its assets identified in CIP-002 containing low impact BES Cyber Systems, but did not address four or more of the six topics required by R1. (R1.2)</p> <p>OR</p> <p>The Responsible Entity did not have any documented cyber security policies for its assets identified in CIP-002 containing low impact BES Cyber Systems as required by R1. (R1.2)</p> <p>OR</p> <p>The Responsible Entity did not</p>

R #	Time Horizon	VRF	Violation Severity Levels (CIP-003-87)			
			Lower VSL	Moderate VSL	High VSL	Severe VSL
			<p>months but did complete this review in less than or equal to 16 calendar months of the previous review. (R1.2)</p> <p>OR</p> <p>The Responsible Entity did not complete its approval of the one or more documented cyber security policies for its assets identified in CIP-002 containing low impact BES Cyber Systems as required by Requirement R1 by the CIP Senior Manager within 15 calendar months but did complete this approval in less than or equal to 16 calendar months of</p>	<p>months but did complete this review in less than or equal to 17 calendar months of the previous review. (R1.2)</p> <p>OR</p> <p>The Responsible Entity did not complete its approval of the one or more documented cyber security policies for its assets identified in CIP-002 containing low impact BES Cyber Systems as required by Requirement R1 by the CIP Senior Manager within 16 calendar months but did complete this approval in less than or equal to 17</p>	<p>assets identified in CIP-002 containing low impact BES Cyber Systems as required by Requirement R1 by the CIP Senior Manager within 17 calendar months but did complete this approval in less than or equal to 18 calendar months of the previous approval. (R1.2)</p>	<p>complete its approval of the one or more documented cyber security policies for its assets identified in CIP-002 containing low impact BES Cyber Systems as required by Requirement R1 by the CIP Senior Manager within 18 calendar months of the previous approval. (R1.2)</p>

R #	Time Horizon	VRF	Violation Severity Levels (CIP-003-87)			
			Lower VSL	Moderate VSL	High VSL	Severe VSL
			the previous approval. (R1.2)	calendar months of the previous approval. (R1.2)		
<b>R2</b>	<b>Operations Planning</b>	<b>Lower</b>	<p>The Responsible Entity documented its cyber security plan(s) for its assets containing low impact BES Cyber Systems, but failed to document cyber security awareness according to Requirement R2, Attachment 1, Section 1. (R2)</p> <p>OR</p> <p>The Responsible Entity implemented electronic access controls but failed to document its cyber security plan(s) for electronic access controls according to Requirement R2,</p>	<p>The Responsible Entity documented its cyber security plan(s) for its assets containing low impact BES Cyber Systems, but failed to reinforce cyber security practices at least once every 15 calendar months according to Requirement R2, Attachment 1, Section 1. (R2)</p> <p>OR</p> <p>The Responsible Entity documented its cyber security plan(s) for its assets containing low impact BES Cyber Systems, but failed</p>	<p>The Responsible Entity documented the physical access controls for its assets containing low impact BES Cyber Systems, but failed to implement the physical security controls according to Requirement R2, Attachment 1, Section 2. (R2)</p> <p>OR</p> <p>The Responsible Entity documented its cyber security plan(s) for electronic access controls for its assets containing low impact BES Cyber Systems, but failed to permit only necessary inbound and outbound electronic</p>	<p>The Responsible Entity failed to document and implement one or more cyber security plan(s) for its assets containing low impact BES Cyber Systems according to Requirement R2, Attachment 1. (R2)</p>

R #	Time Horizon	VRF	Violation Severity Levels (CIP-003-87)			
			Lower VSL	Moderate VSL	High VSL	Severe VSL
			<p>Attachment 1, Section 3. (R2)</p> <p>OR</p> <p>The Responsible Entity documented its cyber security plan(s) for its assets containing low impact BES Cyber Systems, but failed to document one or more Cyber Security Incident response plan(s) according to Requirement R2, Attachment 1, Section 4. (R2)</p> <p>OR</p> <p>The Responsible Entity documented one or more Cyber Security Incident response plan(s) within its cyber security plan(s) for its assets containing</p>	<p>to document physical security controls according to Requirement R2, Attachment 1, Section 2. (R2)</p> <p>OR</p> <p>The Responsible Entity documented its cyber security plan(s) for its assets containing low impact BES Cyber Systems, but failed to document electronic access controls according to Requirement R2, Attachment 1, Section 3. (R2)</p> <p>OR</p> <p>The Responsible Entity documented its cyber security plan(s) for electronic access controls but</p>	<p>access controls according to Requirement R2, Attachment 1, Section 3.1. (R2)</p> <p>OR</p> <p>The Responsible Entity documented one or more Cyber Security Incident response plan(s) within its cyber security plan(s) for its assets containing low impact BES Cyber Systems, but failed to test each Cyber Security Incident response plan(s) at least once every 36 calendar months according to Requirement R2, Attachment 1, Section 4. (R2)</p> <p>OR</p> <p>The Responsible Entity documented the determination of</p>	

R #	Time Horizon	VRF	Violation Severity Levels (CIP-003-87)			
			Lower VSL	Moderate VSL	High VSL	Severe VSL
			low impact BES Cyber Systems, but failed to update each Cyber Security Incident response plan(s) within 180 days according to Requirement R2, Attachment 1, Section 4. (R2) OR The Responsible Entity documented its plan(s) for Transient Cyber Assets and Removable Media, but failed to manage its Transient Cyber Asset(s) according to Requirement R2, Attachment 1, Section 5.1. (R2) OR The Responsible Entity documented	failed to implement authentication for all Dial-up Connectivity that provides access to low impact BES Cyber System(s), per Cyber Asset capability according to Requirement R2, Attachment 1, Section 3.2 (R2) OR The Responsible Entity documented one or more incident response plan(s) within its cyber security plan(s) for its assets containing low impact BES Cyber Systems, but failed to include the process for identification, classification, and response to Cyber Security Incidents	whether an identified Cyber Security Incident is a Reportable Cyber Security Incident, but failed to notify the Electricity Information Sharing and Analysis Center (E-ISAC) according to Requirement R2, Attachment 1, Section 4. (R2) OR The Responsible Entity documented its plan(s) for Transient Cyber Assets and Removable Media, but failed to implement mitigation for the introduction of malicious code for Transient Cyber Assets managed by the Responsible Entity according to Requirement R2,	

R #	Time Horizon	VRF	Violation Severity Levels (CIP-003-87)			
			Lower VSL	Moderate VSL	High VSL	Severe VSL
			its plan(s) for Transient Cyber Assets, but failed to document the Removable Media section(s) according to Requirement R2, Attachment 1, Section 5.3. (R2)	according to Requirement R2, Attachment 1, Section 4. (R2)  OR The Responsible Entity documented its cyber security plan(s) for its assets containing low impact BES Cyber Systems, but failed to document the determination of whether an identified Cyber Security Incident is a Reportable Cyber Security Incident and subsequent notification to the Electricity Information Sharing and Analysis Center (E-ISAC) according to Requirement R2,	Attachment 1, Section 5.1. (R2)  OR The Responsible Entity documented its plan(s) for Transient Cyber Assets and Removable Media, but failed to implement mitigation for the introduction of malicious code for Transient Cyber Assets managed by a party other than the Responsible Entity according to Requirement R2, Attachment 1, Section 5.2. (R2)  OR The Responsible Entity documented its plan(s) for Transient Cyber Assets and Removable Media, but failed to implement mitigation for	

R #	Time Horizon	VRF	Violation Severity Levels (CIP-003-87)			
			Lower VSL	Moderate VSL	High VSL	Severe VSL
				<p>Attachment 1, Section 4. (R2)</p> <p>OR</p> <p>The Responsible Entity documented its plan(s) for Transient Cyber Assets and Removable Media, but failed to document mitigation for the introduction of malicious code for Transient Cyber Assets managed by the Responsible Entity according to Requirement R2, Attachment 1, Sections 5.1 and 5.3. (R2)</p> <p>OR</p> <p>The Responsible Entity documented its plan(s) for Transient Cyber</p>	<p>the threat of detected malicious code on the Removable Media prior to connecting Removable Media to a low impact BES Cyber System according to Requirement R2, Attachment 1, Section 5.3. (R2)</p>	

R #	Time Horizon	VRF	Violation Severity Levels (CIP-003-87)			
			Lower VSL	Moderate VSL	High VSL	Severe VSL
				<p>Assets and Removable Media, but failed to document mitigation for the introduction of malicious code for Transient Cyber Assets managed by a party other than the Responsible Entity according to Requirement R2, Attachment 1, Section 5.2. (R2)</p> <p>OR</p> <p>The Responsible Entity documented its plan(s) for Transient Cyber Assets and Removable Media, but failed to implement the Removable Media section(s) according to Requirement R2,</p>		



R #	Time Horizon	VRF	Violation Severity Levels (CIP-003-87)			
			Lower VSL	Moderate VSL	High VSL	Severe VSL
				Attachment 1, Section 5.3. (R2)		
<b>R3</b>	<b>Operations Planning</b>	<b>Medium</b>	The Responsible Entity has identified by name a CIP Senior Manager, but did not document changes to the CIP Senior Manager within 30 calendar days but did document this change in less than 40 calendar days of the change. (R3)	The Responsible Entity has identified by name a CIP Senior Manager, but did not document changes to the CIP Senior Manager within 40 calendar days but did document this change in less than 50 calendar days of the change. (R3)	The Responsible Entity has identified by name a CIP Senior Manager, but did not document changes to the CIP Senior Manager within 50 calendar days but did document this change in less than 60 calendar days of the change. (R3)	The Responsible Entity has not identified, by name, a CIP Senior Manager.  OR The Responsible Entity has identified by name a CIP Senior Manager, but did not document changes to the CIP Senior Manager within 60 calendar days of the change. (R3)
<b>R4</b>	<b>Operations Planning</b>	<b>Lower</b>	The Responsible Entity has identified a delegate by name, title, date of delegation, and specific actions delegated, but did	The Responsible Entity has identified a delegate by name, title, date of delegation, and specific actions delegated, but did	The Responsible Entity has identified a delegate by name, title, date of delegation, and specific actions delegated, but did not document changes to the delegate	The Responsible Entity has used delegated authority for actions where allowed by the CIP Standards, but does not have a process

R #	Time Horizon	VRF	Violation Severity Levels (CIP-003-87)			
			Lower VSL	Moderate VSL	High VSL	Severe VSL
			not document changes to the delegate within 30 calendar days but did document this change in less than 40 calendar days of the change. (R4)	not document changes to the delegate within 40 calendar days but did document this change in less than 50 calendar days of the change. (R4)	within 50 calendar days but did document this change in less than 60 calendar days of the change. (R4)	to delegate actions from the CIP Senior Manager. (R4)  OR The Responsible Entity has identified a delegate by name, title, date of delegation, and specific actions delegated, but did not document changes to the delegate within 60 calendar days of the change. (R4)

**D. Regional Variances**

None.

**E. Interpretations**

None.

**F. Associated Documents**

None.

## Version History

Version	Date	Action	Change Tracking
1	1/16/06	R3.2 — Change “Control Center” to “control center.”	3/24/06
2	9/30/09	<p>Modifications to clarify the requirements and to bring the compliance elements into conformance with the latest guidelines for developing compliance elements of standards.</p> <p>Removal of reasonable business judgment.</p> <p>Replaced the RRO with the RE as a responsible entity.</p> <p>Rewording of Effective Date.</p> <p>Changed compliance monitor to Compliance Enforcement Authority.</p>	
3	12/16/09	<p>Updated Version Number from -2 to -3</p> <p>In Requirement 1.6, deleted the sentence pertaining to removing component or system from service in order to perform testing, in response to FERC order issued September 30, 2009.</p>	
3	12/16/09	Approved by the NERC Board of Trustees.	
3	3/31/10	Approved by FERC.	
4	1/24/11	Approved by the NERC Board of Trustees.	
5	11/26/12	Adopted by the NERC Board of Trustees.	Modified to coordinate with other CIP standards and to revise format to use RBS Template.
5	11/22/13	FERC Order issued approving CIP-003-5.	

Version	Date	Action	Change Tracking
6	11/13/14	Adopted by the NERC Board of Trustees.	Addressed two FERC directives from Order No. 791 related to identify, assess, and correct language and communication networks.
6	2/12/15	Adopted by the NERC Board of Trustees.	Replaces the version adopted by the Board on 11/13/2014. Revised version addresses remaining directives from Order No. 791 related to transient devices and low impact BES Cyber Systems.
6	1/21/16	FERC Order issued approving CIP-003-6. Docket No. RM15-14-000	
7	2/9/17	Adopted by the NERC Board of Trustees.	Revised to address FERC Order No. 822 directives regarding (1) the definition of LERC and (2) transient devices.
7	4/19/18	FERC Order issued approving CIP-003-7. Docket No. RM17-11-000	

Version	Date	Action	Change Tracking
<u>8</u>		<u>FERC Order issued approving CIP-003-7.</u> <u>Docket No. RM17-11-000</u>	

## Attachment 1

### Required Sections for Cyber Security Plan(s) for Assets Containing Low Impact BES Cyber Systems

Responsible Entities shall include each of the sections provided below in the cyber security plan(s) required under Requirement R2.

Responsible Entities with multiple-impact BES Cyber Systems ratings can utilize policies, procedures, and processes for their high or medium impact BES Cyber Systems to fulfill the sections for the development of low impact cyber security plan(s). Each Responsible Entity can develop a cyber security plan(s) either by individual asset or groups of assets.

**Section 1. Cyber Security Awareness:** Each Responsible Entity shall reinforce, at least once every 15 calendar months, cyber security practices (which may include associated physical security practices).

**Section 2. Physical Security Controls:** Each Responsible Entity shall control physical access, based on need as determined by the Responsible Entity, to (1) the asset or the locations of the low impact BES Cyber Systems within the asset, and (2) the Cyber Asset(s), as specified by the Responsible Entity, that provide electronic access control(s) implemented for Section 3.1, if any.

**Section 3. Electronic Access Controls:** For each asset containing low impact BES Cyber System(s) identified pursuant to CIP-002, the Responsible Entity shall implement electronic access controls to:

- 3.1** Permit only necessary inbound and outbound electronic access as determined by the Responsible Entity for any communications that are:
  - i. between a low impact BES Cyber System(s) and a Cyber Asset(s) outside the asset containing low impact BES Cyber System(s);
  - ii. using a routable protocol when entering or leaving the asset containing the low impact BES Cyber System(s); and
  - iii. not used for time-sensitive protection or control functions between intelligent electronic devices (e.g., communications using protocol IEC TR-61850-90-5 R-GOOSE).
- 3.2** Authenticate all Dial-up Connectivity, if any, that provides access to low impact BES Cyber System(s), per Cyber Asset capability.

**Section 4. Cyber Security Incident Response:** Each Responsible Entity shall have one or more Cyber Security Incident response plan(s), either by asset or group of assets, which shall include:

- 4.1** Identification, classification, and response to Cyber Security Incidents;
- 4.2** Determination of whether an identified Cyber Security Incident is a Reportable Cyber Security Incident and subsequent notification to the

Electricity Information Sharing and Analysis Center (E-ISAC), unless prohibited by law;

- 4.3 Identification of the roles and responsibilities for Cyber Security Incident response by groups or individuals;
- 4.4 Incident handling for Cyber Security Incidents;
- 4.5 Testing the Cyber Security Incident response plan(s) at least once every 36 calendar months by: (1) responding to an actual Reportable Cyber Security Incident; (2) using a drill or tabletop exercise of a Reportable Cyber Security Incident; or (3) using an operational exercise of a Reportable Cyber Security Incident; and
- 4.6 Updating the Cyber Security Incident response plan(s), if needed, within 180 calendar days after completion of a Cyber Security Incident response plan(s) test or actual Reportable Cyber Security Incident.

**Section 5. Transient Cyber Asset and Removable Media Malicious Code Risk Mitigation:** Each Responsible Entity shall implement, except under CIP Exceptional Circumstances, one or more plan(s) to achieve the objective of mitigating the risk of the introduction of malicious code to low impact BES Cyber Systems through the use of Transient Cyber Assets or Removable Media. The plan(s) shall include:

- 5.1 For Transient Cyber Asset(s) managed by the Responsible Entity, if any, the use of one or a combination of the following in an ongoing or on-demand manner (per Transient Cyber Asset capability):
  - Antivirus software, including manual or managed updates of signatures or patterns;
  - Application whitelisting; or
  - Other method(s) to mitigate the introduction of malicious code.
- 5.2 For Transient Cyber Asset(s) managed by a party other than the Responsible Entity, if any:
  - ~~5.1.15.2.1~~ 5.1.15.2.1 the use of one or a combination of the following prior to connecting the Transient Cyber Asset to a low impact BES Cyber System (per Transient Cyber Asset capability):
    - Review of antivirus update level;
    - Review of antivirus update process used by the party;
    - Review of application whitelisting used by the party;
    - Review use of live operating system and software executable only from read-only media;
    - Review of system hardening used by the party; or

- Other method(s) to mitigate the introduction of malicious code.

5.1.25.2.2 For any method used pursuant to 5.2.1, Responsible Entities shall determine whether any additional mitigation actions are necessary and implement such actions prior to connecting the Transient Cyber Asset.

5.25.3 For Removable Media, the use of each of the following:

5.2.15.3.1 Method(s) to detect malicious code on Removable Media using a Cyber Asset other than a BES Cyber System; and

5.2.25.3.2 Mitigation of the threat of detected malicious code on the Removable Media prior to connecting Removable Media to a low impact BES Cyber System.



## Attachment 2

### Examples of Evidence for Cyber Security Plan(s) for Assets Containing Low Impact BES Cyber Systems

**Section 1. Cyber Security Awareness:** An example of evidence for Section 1 may include, but is not limited to, documentation that the reinforcement of cyber security practices occurred at least once every 15 calendar months. The evidence could be documentation through one or more of the following methods:

- Direct communications (for example, e-mails, memos, or computer-based training);
- Indirect communications (for example, posters, intranet, or brochures); or
- Management support and reinforcement (for example, presentations or meetings).

**Section 2. Physical Security Controls:** Examples of evidence for Section 2 may include, but are not limited to:

- Documentation of the selected access control(s) (e.g., card key, locks, perimeter controls), monitoring controls (e.g., alarm systems, human observation), or other operational, procedural, or technical physical security controls that control physical access to both:
  - a. The asset, if any, or the locations of the low impact BES Cyber Systems within the asset; and
  - b. The Cyber Asset(s) specified by the Responsible Entity that provide(s) electronic access controls implemented for Attachment 1, Section 3.1, if any.

**Section 3. Electronic Access Controls:** Examples of evidence for Section 3 may include, but are not limited to:

1. Documentation showing that at each asset or group of assets containing low impact BES Cyber Systems, routable communication between a low impact BES Cyber System(s) and a Cyber Asset(s) outside the asset is restricted by electronic access controls to permit only inbound and outbound electronic access that the Responsible Entity deems necessary, except where an entity provides rationale that communication is used for time-sensitive protection or control functions between intelligent electronic devices. Examples of such documentation may include, but are not limited to representative diagrams that illustrate control of inbound and outbound communication(s) between the low impact BES Cyber System(s) and a Cyber Asset(s) outside the asset containing low impact BES Cyber System(s) or lists of implemented electronic access controls (e.g., access control lists restricting IP addresses, ports, or services; implementing unidirectional gateways).

2. Documentation of authentication for Dial-up Connectivity (e.g., dial out only to a preprogrammed number to deliver data, dial-back modems, modems that must be remotely controlled by the control center or control room, or access control on the BES Cyber System).

**Section 4. Cyber Security Incident Response:** An example of evidence for Section 4 may include, but is not limited to, dated documentation, such as policies, procedures, or process documents of one or more Cyber Security Incident response plan(s) developed either by asset or group of assets that include the following processes:

1. to identify, classify, and respond to Cyber Security Incidents; to determine whether an identified Cyber Security Incident is a Reportable Cyber Security Incident and for notifying the Electricity Information Sharing and Analysis Center (E-ISAC);
2. to identify and document the roles and responsibilities for Cyber Security Incident response by groups or individuals (e.g., initiating, documenting, monitoring, reporting, etc.);
3. for incident handling of a Cyber Security Incident (e.g., containment, eradication, or recovery/incident resolution);
4. for testing the plan(s) along with the dated documentation that a test has been completed at least once every 36 calendar months; and
5. to update, as needed, Cyber Security Incident response plan(s) within 180 calendar days after completion of a test or actual Reportable Cyber Security Incident.

**Section 5. Transient Cyber Asset and Removable Media Malicious Code Risk Mitigation:**

1. Examples of evidence for Section 5.1 may include, but are not limited to, documentation of the method(s) used to mitigate the introduction of malicious code such as antivirus software and processes for managing signature or pattern updates, application whitelisting practices, processes to restrict communication, or other method(s) to mitigate the introduction of malicious code. If a Transient Cyber Asset does not have the capability to use method(s) that mitigate the introduction of malicious code, evidence may include documentation by the vendor or Responsible Entity that identifies that the Transient Cyber Asset does not have the capability.
2. Examples of evidence for Section 5.2.1 may include, but are not limited to, documentation from change management systems, electronic mail or procedures that document a review of the installed antivirus update level; memoranda, electronic mail, system documentation, policies or contracts from the party other than the Responsible Entity that identify the antivirus update process, the use of application whitelisting, use of live operating systems or system hardening performed by the party other than the Responsible Entity; evidence from change management systems, electronic mail or contracts that

identifies the Responsible Entity's acceptance that the practices of the party other than the Responsible Entity are acceptable; or documentation of other method(s) to mitigate malicious code for Transient Cyber Asset(s) managed by a party other than the Responsible Entity. If a Transient Cyber Asset does not have the capability to use method(s) that mitigate the introduction of malicious code, evidence may include documentation by the Responsible Entity or the party other than the Responsible Entity that identifies that the Transient Cyber Asset does not have the capability.

Examples of evidence for Attachment 1, Section 5.2.2 may include, but are not limited to, documentation from change management systems, electronic mail, or contracts that identifies a review to determine whether additional mitigation is necessary and has been implemented prior to connecting the Transient Cyber Asset managed by a party other than the Responsible Entity.

~~2.3.~~ Examples of evidence for Section 5.3.1 may include, but are not limited to, documented process(es) of the method(s) used to detect malicious code such as results of scan settings for Removable Media, or implementation of on-demand scanning. Examples of evidence for Section 5.3.2 may include, but are not limited to, documented process(es) for the method(s) used for mitigating the threat of detected malicious code on Removable Media, such as logs from the method(s) used to detect malicious code that show the results of scanning and the mitigation of detected malicious code on Removable Media or documented confirmation by the entity that the Removable Media was deemed to be free of malicious code.

## Guidelines and Technical Basis

### Section 4 – Scope of Applicability of the CIP Cyber Security Standards

Section “4. Applicability” of the standards provides important information for Responsible Entities to determine the scope of the applicability of the CIP Cyber Security Requirements.

Section “4.1. Functional Entities” is a list of NERC functional entities to which the standard applies. If the entity is registered as one or more of the functional entities listed in Section 4.1, then the NERC CIP Cyber Security Standards apply. Note that there is a qualification in Section 4.1 that restricts the applicability in the case of Distribution Providers to only those that own certain types of systems and equipment listed in 4.2.

Section “4.2. Facilities” defines the scope of the Facilities, systems, and equipment owned by the Responsible Entity, as qualified in Section 4.1, that is subject to the requirements of the standard. In addition to the set of BES Facilities, Control Centers, and other systems and equipment, the list includes the set of systems and equipment owned by Distribution Providers. While the NERC Glossary term “Facilities” already includes the BES characteristic, the additional use of the term BES here is meant to reinforce the scope of applicability of these Facilities where it is used, especially in this applicability scoping section. This in effect sets the scope of Facilities, systems, and equipment that is subject to the standards.

#### Requirement R1:

In developing policies in compliance with Requirement R1, the number of policies and their content should be guided by a Responsible Entity's management structure and operating conditions. Policies might be included as part of a general information security program for the entire organization, or as components of specific programs. The Responsible Entity has the flexibility to develop a single comprehensive cyber security policy covering the required topics, or it may choose to develop a single high-level umbrella policy and provide additional policy detail in lower level documents in its documentation hierarchy. In the case of a high-level umbrella policy, the Responsible Entity would be expected to provide the high-level policy as well as the additional documentation in order to demonstrate compliance with CIP-003-~~87~~, Requirement R1.

If a Responsible Entity has any high or medium impact BES Cyber Systems, the one or more cyber security policies must cover the nine subject matter areas required by CIP-003-~~87~~, Requirement R1, Part 1.1. If a Responsible Entity has identified from CIP-002 any assets containing low impact BES Cyber Systems, the one or more cyber security policies must cover the six subject matter areas required by Requirement R1, Part 1.2.

Responsible Entities that have multiple-impact rated BES Cyber Systems are not required to create separate cyber security policies for high, medium, or low impact BES Cyber Systems. The Responsible Entities have the flexibility to develop policies that cover all three impact ratings.

Implementation of the cyber security policy is not specifically included in CIP-003-~~78~~, Requirement R1 as it is envisioned that the implementation of this policy is evidenced through successful implementation of CIP-003 through CIP-011. However, Responsible Entities are encouraged not to limit the scope of their cyber security policies to only those requirements in NERC cyber security Reliability Standards, but to develop a holistic cyber security policy

appropriate for its organization. Elements of a policy that extend beyond the scope of NERC's cyber security Reliability Standards will not be considered candidates for potential violations although they will help demonstrate the organization's internal culture of compliance and posture towards cyber security.

For Part 1.1, the Responsible Entity may consider the following for each of the required topics in its one or more cyber security policies for medium and high impact BES Cyber Systems, if any:

1.1.1 Personnel and training (CIP-004)

- Organization position on acceptable background investigations
- Identification of possible disciplinary action for violating this policy
- Account management

1.1.2 Electronic Security Perimeters (CIP-005) including Interactive Remote Access

- Organization stance on use of wireless networks
- Identification of acceptable authentication methods
- Identification of trusted and untrusted resources
- Monitoring and logging of ingress and egress at Electronic Access Points
- Maintaining up-to-date anti-malware software before initiating Interactive Remote Access
- Maintaining up-to-date patch levels for operating systems and applications used to initiate Interactive Remote Access
- Disabling VPN "split-tunneling" or "dual-homed" workstations before initiating Interactive Remote Access
- For vendors, contractors, or consultants: include language in contracts that requires adherence to the Responsible Entity's Interactive Remote Access controls

1.1.3 Physical security of BES Cyber Systems (CIP-006)

- Strategy for protecting Cyber Assets from unauthorized physical access
- Acceptable physical access control methods
- Monitoring and logging of physical ingress

1.1.4 System security management (CIP-007)

- Strategies for system hardening
- Acceptable methods of authentication and access control
- Password policies including length, complexity, enforcement, prevention of brute force attempts
- Monitoring and logging of BES Cyber Systems

- 1.1.5 Incident reporting and response planning (CIP-008)
  - Recognition of Cyber Security Incidents
  - Appropriate notifications upon discovery of an incident
  - Obligations to report Cyber Security Incidents
- 1.1.6 Recovery plans for BES Cyber Systems (CIP-009)
  - Availability of spare components
  - Availability of system backups
- 1.1.7 Configuration change management and vulnerability assessments (CIP-010)
  - Initiation of change requests
  - Approval of changes
  - Break-fix processes
- 1.1.8 Information protection (CIP-011)
  - Information access control methods
  - Notification of unauthorized information disclosure
  - Information access on a need-to-know basis
- 1.1.9 Declaring and responding to CIP Exceptional Circumstances
  - Processes to invoke special procedures in the event of a CIP Exceptional Circumstance
  - Processes to allow for exceptions to policy that do not violate CIP requirements

For Part 1.2, the Responsible Entity may consider the following for each of the required topics in its one or more cyber security policies for assets containing low impact BES Cyber Systems, if any:

- 1.2.1 Cyber security awareness
  - Method(s) for delivery of security awareness
  - Identification of groups to receive cyber security awareness
- 1.2.2 Physical security controls
  - Acceptable approach(es) for selection of physical security control(s)
- 1.2.3 Electronic access controls
  - Acceptable approach(es) for selection of electronic access control(s)
- 1.2.4 Cyber Security Incident response
  - Recognition of Cyber Security Incidents

- Appropriate notifications upon discovery of an incident
- Obligations to report Cyber Security Incidents

#### 1.2.5 Transient Cyber Assets and Removable Media Malicious Code Risk Mitigation

- Acceptable use of Transient Cyber Asset(s) and Removable Media
- Method(s) to mitigate the risk of the introduction of malicious code to low impact BES Cyber Systems from Transient Cyber Assets and Removable Media
- Method(s) to request Transient Cyber Asset and Removable Media

#### 1.2.6 Declaring and responding to CIP Exceptional Circumstances

- Process(es) to declare a CIP Exceptional Circumstance
- Process(es) to respond to a declared CIP Exceptional Circumstance

Requirements relating to exceptions to a Responsible Entity's security policies were removed because it is a general management issue that is not within the scope of a reliability requirement. It is an internal policy requirement and not a reliability requirement. However, Responsible Entities are encouraged to continue this practice as a component of their cyber security policies.

In this and all subsequent required approvals in the NERC CIP Reliability Standards, the Responsible Entity may elect to use hardcopy or electronic approvals to the extent that there is sufficient evidence to ensure the authenticity of the approving party.

#### **Requirement R2:**

The intent of Requirement R2 is for each Responsible Entity to create, document, and implement one or more cyber security plan(s) that address the security objective for the protection of low impact BES Cyber Systems. The required protections are designed to be part of a program that covers the low impact BES Cyber Systems collectively at an asset level (based on the list of assets containing low impact BES Cyber Systems identified in CIP-002), but not at an individual device or system level.

### **Requirement R2, Attachment 1**

As noted, Attachment 1 contains the sections that must be included in the cyber security plan(s). The intent is to allow entities that have a combination of high, medium, and low impact BES Cyber Systems the flexibility to choose, if desired, to cover their low impact BES Cyber Systems (or any subset) under their programs used for the high or medium impact BES Cyber Systems rather than maintain two separate programs. The purpose of the cyber security plan(s) in Requirement R2 is for Responsible Entities to use the cyber security plan(s) as a means of documenting their approaches to meeting the subject matter areas. The cyber security plan(s) can be used to reference other policies and procedures that demonstrate “how” the Responsible Entity is meeting each of the subject matter areas, or Responsible Entities can develop comprehensive cyber security plan(s) that contain all of the detailed implementation content solely within the cyber security plan itself. To meet the obligation for the cyber security plan, the expectation is that the cyber security plan contains or references sufficient details to address the implementation of each of the required subject matters areas.

Guidance for each of the subject matter areas of Attachment 1 is provided below.

#### **Requirement R2, Attachment 1, Section 1 – Cyber Security Awareness**

The intent of the cyber security awareness program is for entities to reinforce good cyber security practices with their personnel at least once every 15 calendar months. The entity has the discretion to determine the topics to be addressed and the manner in which it will communicate these topics. As evidence of compliance, the Responsible Entity should be able to produce the awareness material that was delivered according to the delivery method(s) (e.g., posters, emails, or topics at staff meetings, etc.). The standard drafting team does not intend for Responsible Entities to be required to maintain lists of recipients and track the reception of the awareness material by personnel.

Although the focus of the awareness is cyber security, it does not mean that only technology-related topics can be included in the program. Appropriate physical security topics (e.g., tailgating awareness and protection of badges for physical security, or “If you see something, say something” campaigns, etc.) are valid for cyber security awareness. The intent is to cover topics concerning any aspect of the protection of BES Cyber Systems.

#### **Requirement R2, Attachment 1, Section 2 – Physical Security Controls**

The Responsible Entity must document and implement methods to control physical access to (1) the asset or the locations of low impact BES Cyber Systems within the asset, and (2) Cyber Assets that implement the electronic access control(s) specified by the Responsible Entity in Attachment 1, Section 3.1, if any. If these Cyber Assets implementing the electronic access controls are located within the same asset as the low impact BES Cyber Asset(s) and inherit the same physical access controls and the same need as outlined in Section 2, this may be noted by the Responsible Entity in either its policies or cyber security plan(s) to avoid duplicate documentation of the same controls.

The Responsible Entity has the flexibility to select the methods used to meet the objective of controlling physical access to (1) the asset(s) containing low impact BES Cyber System(s) or the low impact BES Cyber Systems themselves and (2) the electronic access control Cyber Assets specified by the Responsible Entity, if any. The Responsible Entity may use one or a



combination of physical access controls, monitoring controls, or other operational, procedural, or technical physical security controls. Entities may use perimeter controls (e.g., fences with locked gates, guards, or site access policies, etc.) or more granular areas of physical access control in areas where low impact BES Cyber Systems are located, such as control rooms or control houses.

The security objective is to control the physical access based on need as determined by the Responsible Entity. The need for physical access can be documented at the policy level. The standard drafting team did not intend to obligate an entity to specify a need for each physical access or authorization of an individual for physical access.

Monitoring as a physical security control can be used as a complement or an alternative to physical access control. Examples of monitoring controls include, but are not limited to: (1) alarm systems to detect motion or entry into a controlled area, or (2) human observation of a controlled area. Monitoring does not necessarily require logging and maintaining logs but could include monitoring that physical access has occurred or been attempted (e.g., door alarm, or human observation, etc.). The standard drafting team's intent is that the monitoring does not need to be per low impact BES Cyber System but should be at the appropriate level to meet the security objective of controlling physical access.

User authorization programs and lists of authorized users for physical access are not required although they are an option to meet the security objective.

#### **Requirement R2, Attachment 1, Section 3 – Electronic Access Controls**

Section 3 requires the establishment of electronic access controls for assets containing low impact BES Cyber Systems when there is routable protocol communication or Dial-up Connectivity between Cyber Asset(s) outside of the asset containing the low impact BES Cyber System(s) and the low impact BES Cyber System(s) within such asset. The establishment of electronic access controls is intended to reduce the risks associated with uncontrolled communication using routable protocols or Dial-up Connectivity.

When implementing Attachment 1, Section 3.1, Responsible Entities should note that electronic access controls to permit only necessary inbound and outbound electronic access are required for communications when those communications meet all three of the criteria identified in Attachment 1, Section 3.1. The Responsible Entity should evaluate the communications and when all three criteria are met, the Responsible Entity must document and implement electronic access control(s).

When identifying electronic access controls, Responsible Entities are provided flexibility in the selection of the electronic access controls that meet their operational needs while meeting the security objective of allowing only necessary inbound and outbound electronic access to low impact BES Cyber Systems that use routable protocols between a low impact BES Cyber System(s) and Cyber Asset(s) outside the asset.

In essence, the intent is for Responsible Entities to determine whether there is communication between a low impact BES Cyber System(s) and a Cyber Asset(s) outside the asset containing low impact BES Cyber System(s) that uses a routable protocol when entering or leaving the asset or Dial-up Connectivity to the low impact BES Cyber System(s). Where such

communication is present, Responsible Entities should document and implement electronic access control(s). Where routable protocol communication for time-sensitive protection or control functions between intelligent electronic devices that meets the exclusion language is present, Responsible Entities should document that communication, but are not required to establish any specific electronic access controls.

The inputs to this requirement are the assets identified in CIP-002 as containing low impact BES Cyber System(s); therefore, the determination of routable protocol communications or Dial-up Connectivity is an attribute of the asset. However, it is not intended for communication that provides no access to or from the low impact BES Cyber System(s), but happens to be located at the asset with the low impact BES Cyber System(s), to be evaluated for electronic access controls.

#### Electronic Access Control Exclusion

In order to avoid future technology issues, the obligations for electronic access controls exclude communications between intelligent electronic devices that use routable communication protocols for time-sensitive protection or control functions, such as IEC TR-61850-90-5 R-GOOSE messaging. Time-sensitive in this context generally means functions that would be negatively impacted by the latency introduced in the communications by the required electronic access controls. This time-sensitivity exclusion does not apply to SCADA communications which typically operate on scan rates of 2 seconds or greater. While technically time-sensitive, SCADA communications over routable protocols can withstand the delay introduced by electronic access controls. Examples of excluded time-sensitive communications are those communications which may necessitate the tripping of a breaker within a few cycles. A Responsible Entity using this technology is not expected to implement the electronic access controls noted herein. This exception was included so as not to inhibit the functionality of the time-sensitive characteristics related to this technology and not to preclude the use of such time-sensitive reliability enhancing functions if they use a routable protocol in the future.

#### **Considerations for Determining Routable Protocol Communications**

To determine whether electronic access controls need to be implemented, the Responsible Entity has to determine whether there is communication between a low impact BES Cyber System(s) and a Cyber Asset(s) outside the asset containing the low impact BES Cyber System(s) that uses a routable protocol when entering or leaving the asset.

When determining whether a routable protocol is entering or leaving the asset containing the low impact BES Cyber System(s), Responsible Entities have flexibility in identifying an approach. One approach is for Responsible Entities to identify an “electronic boundary” associated with the asset containing low impact BES Cyber System(s). This is not an Electronic Security Perimeter *per se*, but a demarcation that demonstrates the routable protocol communication entering or leaving the asset between a low impact BES Cyber System and Cyber Asset(s) outside the asset to then have electronic access controls implemented. This electronic boundary may vary by asset type (Control Center, substation, generation resource) and the specific configuration of the asset. If this approach is used, the intent is for the Responsible Entity to define the electronic boundary such that the low impact BES Cyber System(s) located

at the asset are contained within the “electronic boundary.” This is strictly for determining which routable protocol communications and networks are internal or inside or local to the asset and which are external to or outside the asset.

Alternatively, the Responsible Entity may find the concepts of what is inside and outside to be intuitively obvious for a Cyber Asset(s) outside the asset containing low impact BES Cyber System(s) communicating to a low impact BES Cyber System(s) inside the asset. This may be the case when a low impact BES Cyber System(s) is communicating with a Cyber Asset many miles away and a clear and unambiguous demarcation exists. In this case, a Responsible Entity may decide not to identify an “electronic boundary,” but rather to simply leverage the unambiguous asset demarcation to ensure that the electronic access controls are placed between the low impact BES Cyber System(s) and the Cyber Asset(s) outside the asset.

### **Determining Electronic Access Controls**

Once a Responsible Entity has determined that there is routable communication between a low impact BES Cyber System(s) and a Cyber Asset(s) outside the asset containing the low impact BES Cyber System(s) that uses a routable protocol when entering or leaving the asset containing the low impact BES Cyber System(s), the intent is for the Responsible Entity to document and implement its chosen electronic access control(s). The control(s) are intended to allow only “necessary” inbound and outbound electronic access as determined by the Responsible Entity. However the Responsible Entity chooses to document the inbound and outbound access permissions and the need, the intent is that the Responsible Entity is able to explain the reasons for the electronic access permitted. The reasoning for “necessary” inbound and outbound electronic access controls may be documented within the Responsible Entity’s cyber security plan(s), within a comment on an access control list, a database, spreadsheet or other policies or procedures associated with the electronic access controls.

### **Concept Diagrams**

The diagrams on the following pages are provided as examples to illustrate various electronic access controls at a conceptual level. Regardless of the concepts or configurations chosen by the Responsible Entity, the intent is to achieve the security objective of permitting only necessary inbound and outbound electronic access for communication between low impact BES Cyber Systems and Cyber Asset(s) outside the asset containing the low impact BES Cyber System(s) using a routable protocol when entering or leaving the asset.

#### **NOTE:**

- This is not an exhaustive list of applicable concepts.
- The same legend is used in each diagram; however, the diagram may not contain all of the articles represented in the legend.

**Reference Model 1 – Host-based Inbound & Outbound Access Permissions**

The Responsible Entity may choose to utilize a host-based firewall technology on the low impact BES Cyber System(s) itself that manages the inbound and outbound electronic access permissions so that only necessary inbound and outbound electronic access is allowed between the low impact BES Cyber System(s) and the Cyber Asset(s) outside the asset containing the low impact BES Cyber System(s). When permitting the inbound and outbound electronic access permissions using access control lists, the Responsible Entity could restrict communication(s) using source and destination addresses or ranges of addresses. Responsible Entities could also restrict communication(s) using ports or services based on the capability of the electronic access control, the low impact BES Cyber System(s), or the application(s).

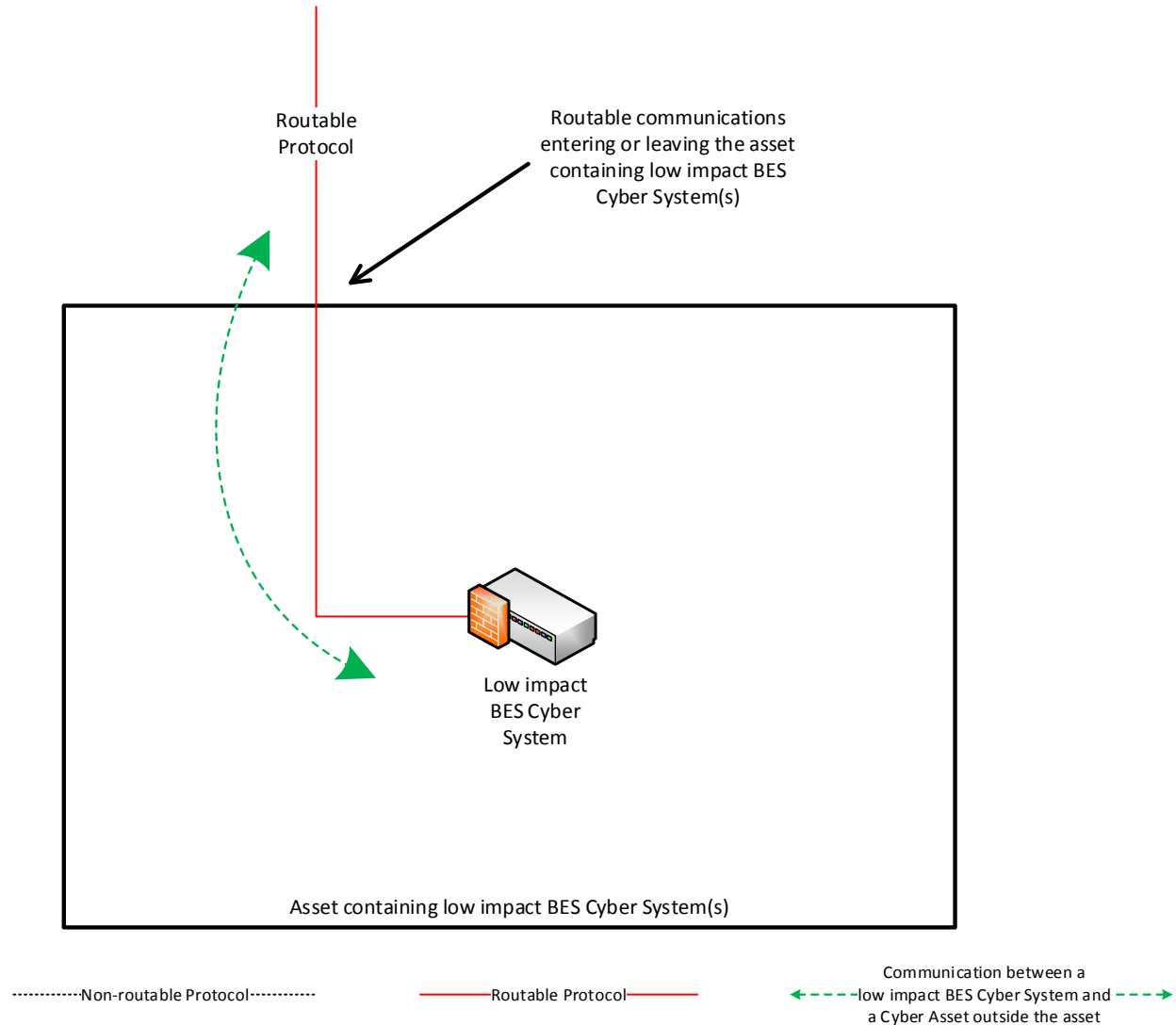

*Reference Model 1*

**Reference Model 2 – Network-based Inbound & Outbound Access Permissions**

The Responsible Entity may choose to use a security device that permits only necessary inbound and outbound electronic access to the low impact BES Cyber System(s) within the asset containing the low impact BES Cyber System(s). In this example, two low impact BES Cyber Systems are accessed using the routable protocol that is entering or leaving the asset containing the low impact BES Cyber System(s). The IP/Serial converter is continuing the same communications session from the Cyber Asset(s) that are outside the asset to the low impact BES Cyber System(s). The security device provides the electronic access controls to permit only necessary inbound and outbound routable protocol access to the low impact BES Cyber System(s). When permitting the inbound and outbound electronic access permissions using access control lists, the Responsible Entity could restrict communication(s) using source and destination addresses or ranges of addresses. Responsible Entities could also restrict communication(s) using ports or services based on the capability of the electronic access control, the low impact BES Cyber System(s), or the application(s).

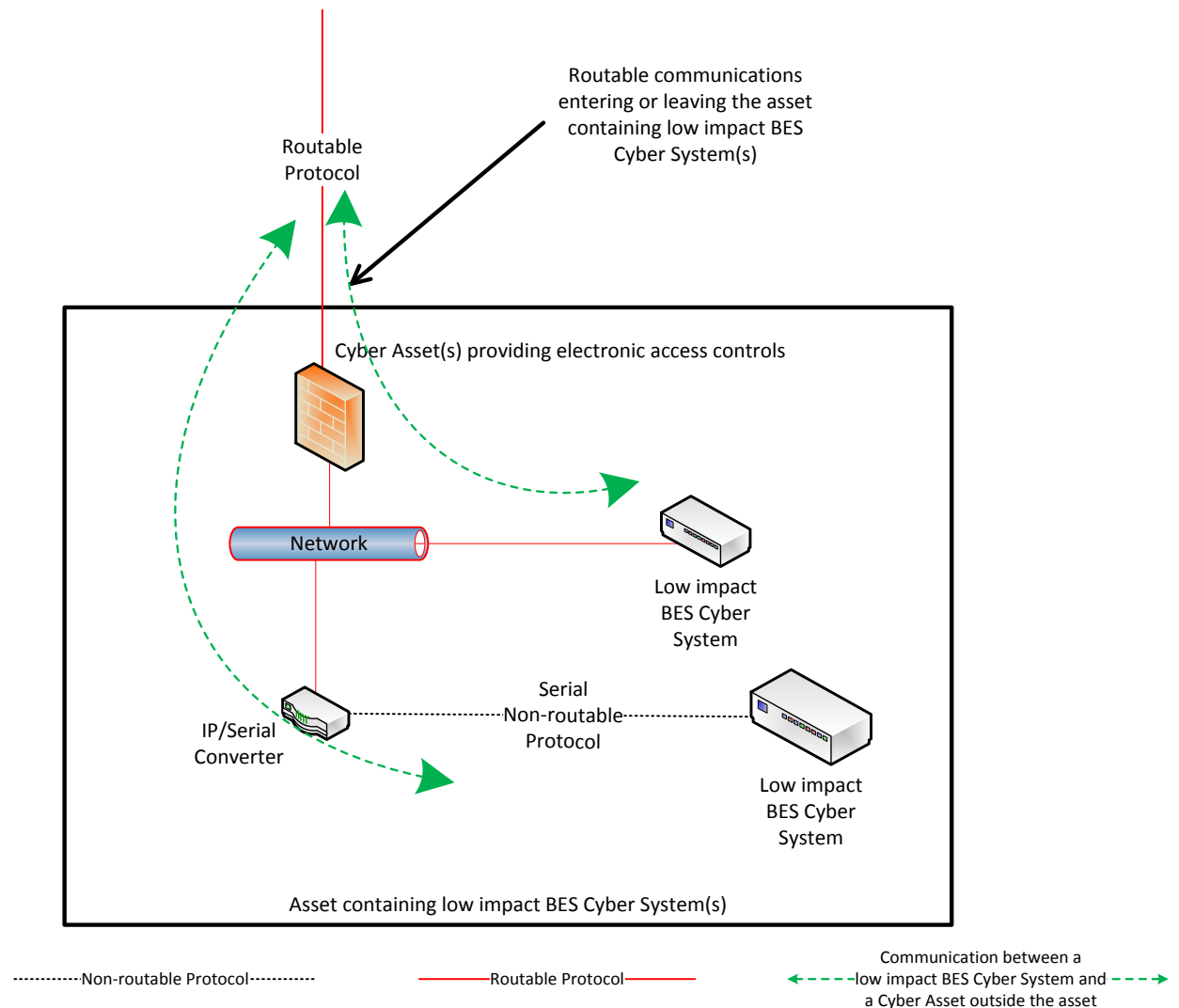

Reference Model 2

### Reference Model 3 – Centralized Network-based Inbound & Outbound Access Permissions

The Responsible Entity may choose to utilize a security device at a centralized location that may or may not be at another asset containing low impact BES Cyber System(s). The electronic access control(s) do not necessarily have to reside inside the asset containing the low impact BES Cyber System(s). A security device is in place at “Location X” to act as the electronic access control and permit only necessary inbound and outbound routable protocol access between the low impact BES Cyber System(s) and the Cyber Asset(s) outside each asset containing low impact BES Cyber System(s). Care should be taken that electronic access to or between each asset is through the Cyber Asset(s) determined by the Responsible Entity to be performing electronic access controls at the centralized location. When permitting the inbound and outbound electronic access permissions using access control lists, the Responsible Entity could restrict communication(s) using source and destination addresses or ranges of addresses. Responsible Entities could also restrict communication(s) using ports or services based on the capability of the electronic access control, the low impact BES Cyber System(s), or the application(s).

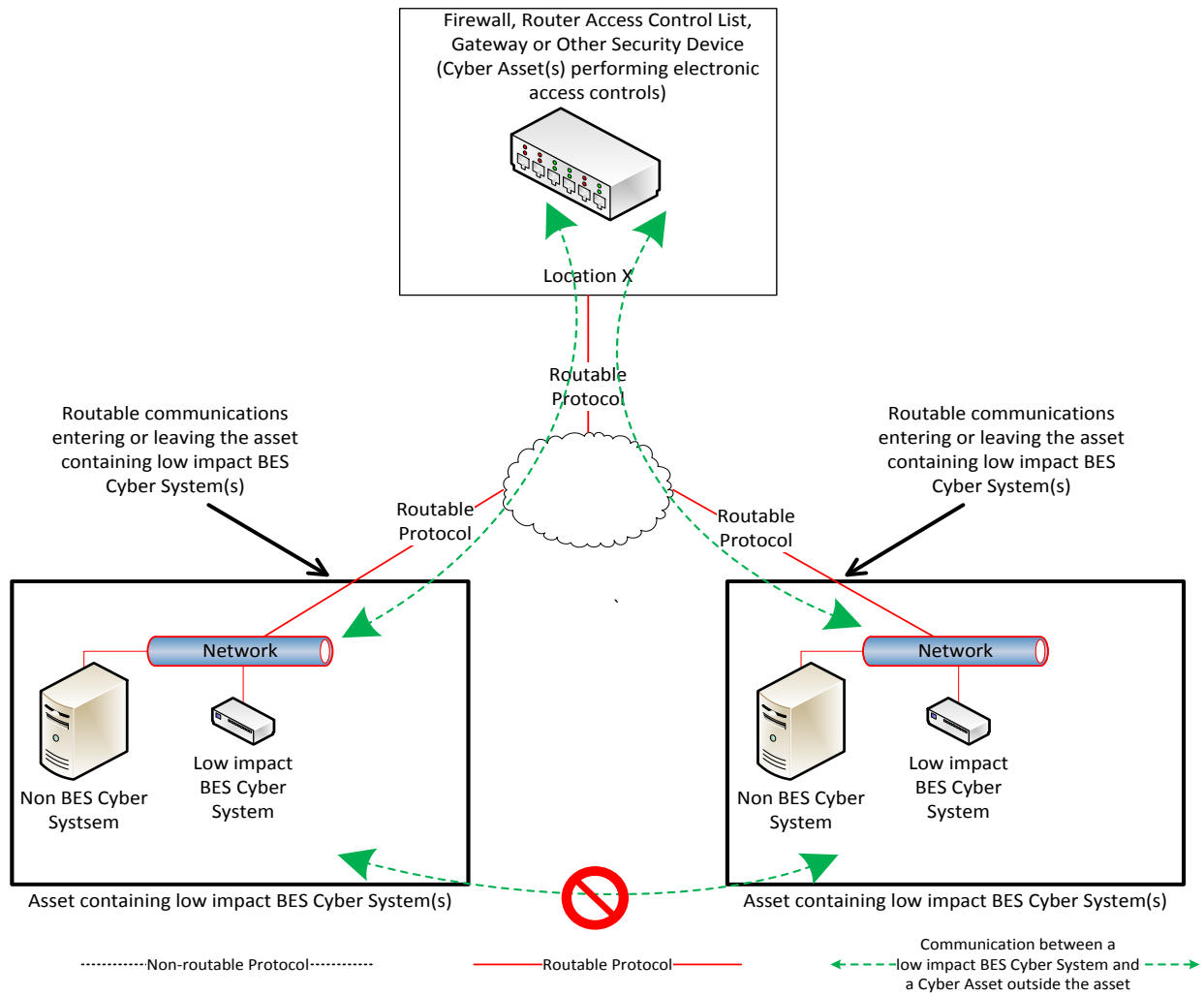

Reference Model 3

**Reference Model 4 – Uni-directional Gateway**

The Responsible Entity may choose to utilize a uni-directional gateway as the electronic access control. The low impact BES Cyber System(s) is not accessible (data cannot flow into the low impact BES Cyber System) using the routable protocol entering the asset due to the implementation of a “one-way” (uni-directional) path for data to flow. The uni-directional gateway is configured to permit only the necessary outbound communications using the routable protocol communication leaving the asset.

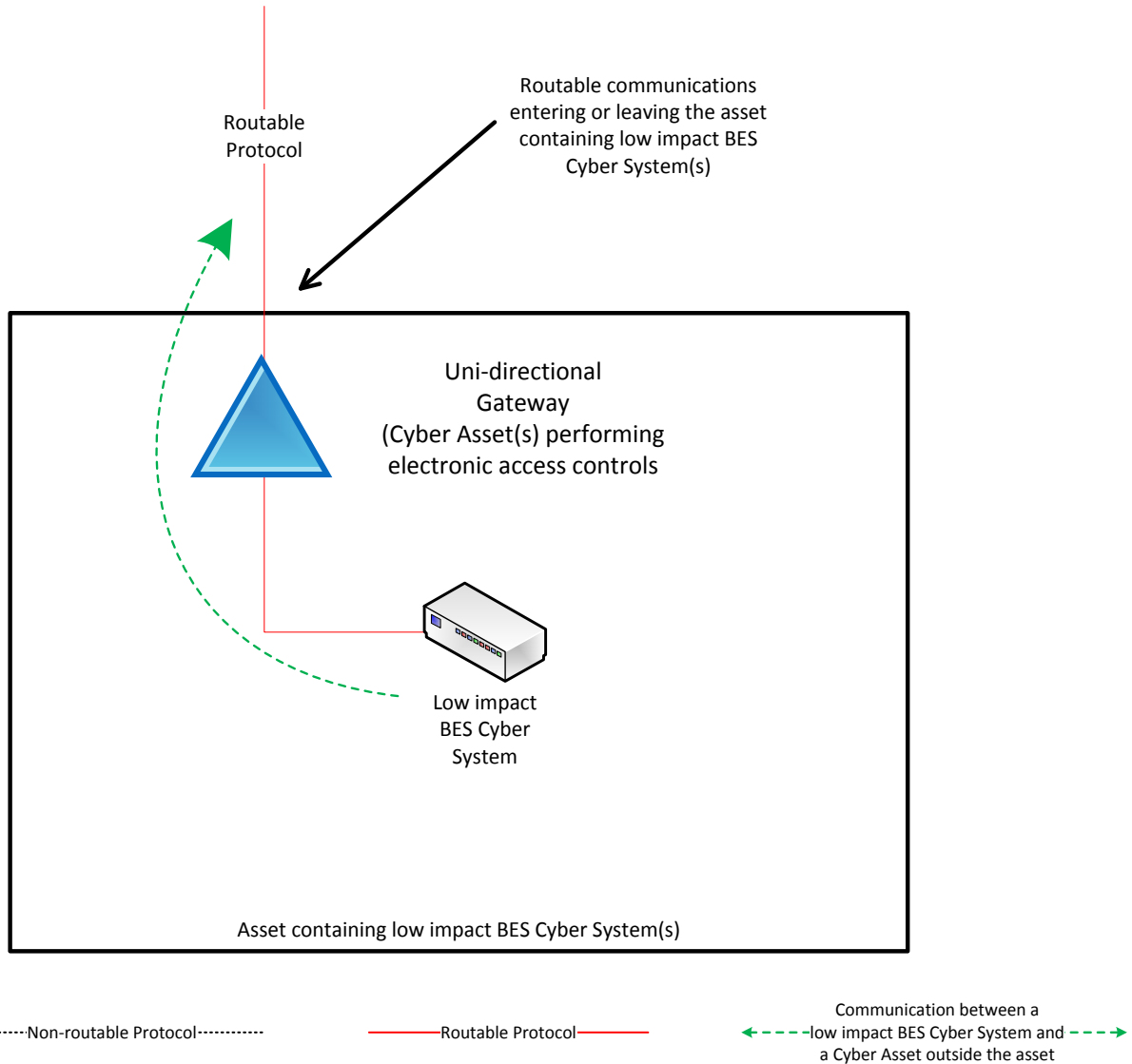

*Reference Model 4*

### Reference Model 5 – User Authentication

This reference model demonstrates that Responsible Entities have flexibility in choosing electronic access controls so long as the security objective of the requirement is met. The Responsible Entity may choose to utilize a non-BES Cyber Asset located at the asset containing the low impact BES Cyber System that requires authentication for communication from the Cyber Asset(s) outside the asset. This non-BES Cyber System performing the authentication permits only authenticated communication to connect to the low impact BES Cyber System(s), meeting the first half of the security objective to permit only necessary inbound electronic access. Additionally, the non-BES Cyber System performing authentication is configured such that it permits only necessary outbound communication meeting the second half of the security objective. Often, the outbound communications would be controlled in this network architecture by permitting no communication to be initiated from the low impact BES Cyber System. This configuration may be beneficial when the only communication to a device is for user-initiated interactive access.

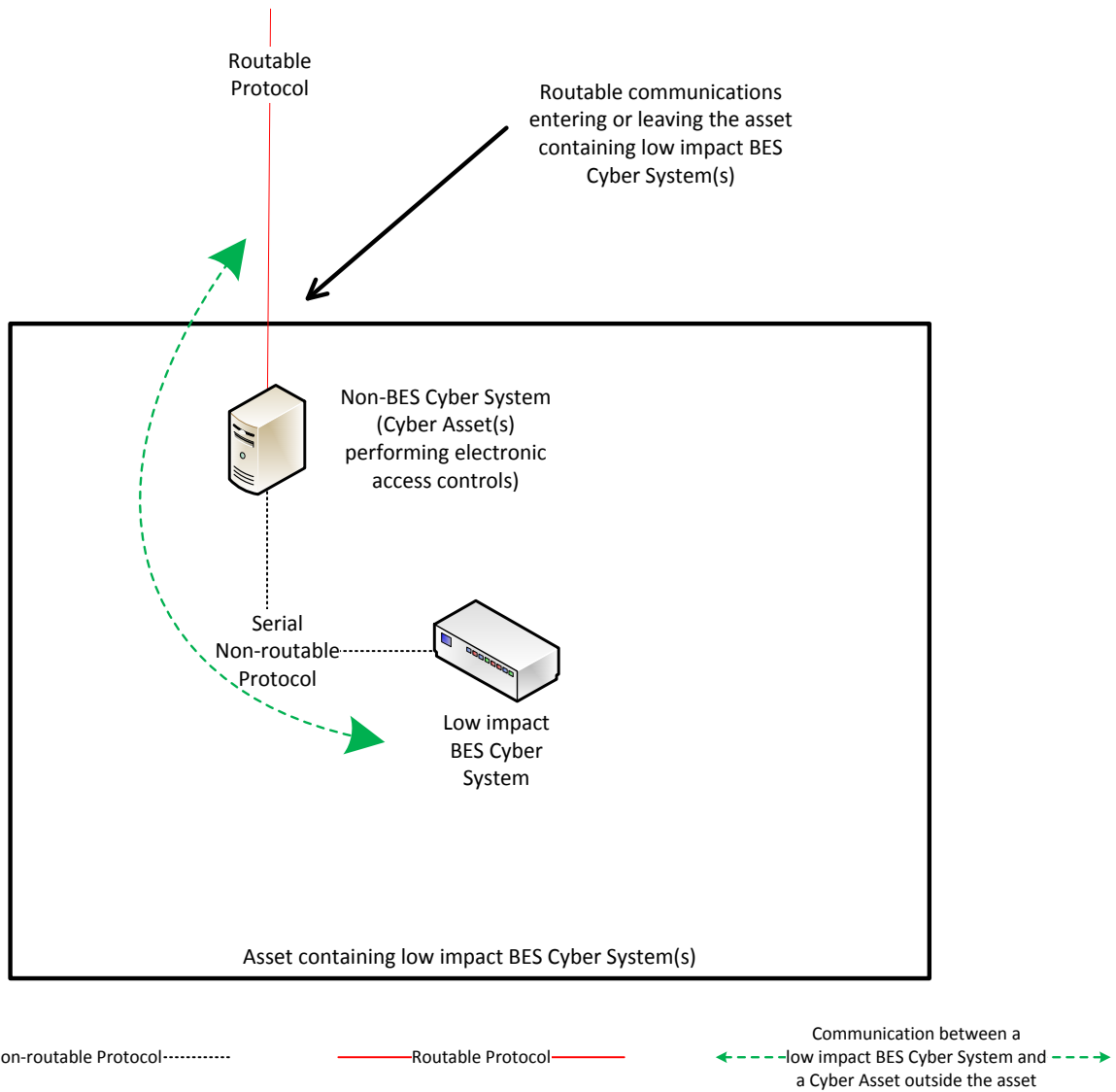

Reference Model 5



### Reference Model 6 – Indirect Access

In implementing its electronic access controls, the Responsible Entity may identify that it has indirect access between the low impact BES Cyber System and a Cyber Asset outside the asset containing the low impact BES Cyber System through a non-BES Cyber Asset located within the asset. This indirect access meets the criteria of having communication between the low impact BES Cyber System and a Cyber Asset outside the asset containing the low impact BES Cyber System. In this reference model, it is intended that the Responsible Entity implement electronic access controls that permit only necessary inbound and outbound electronic access to the low impact BES Cyber System. Consistent with the other reference models provided, the electronic access in this reference model is controlled using the security device that is restricting the communication that is entering or leaving the asset.

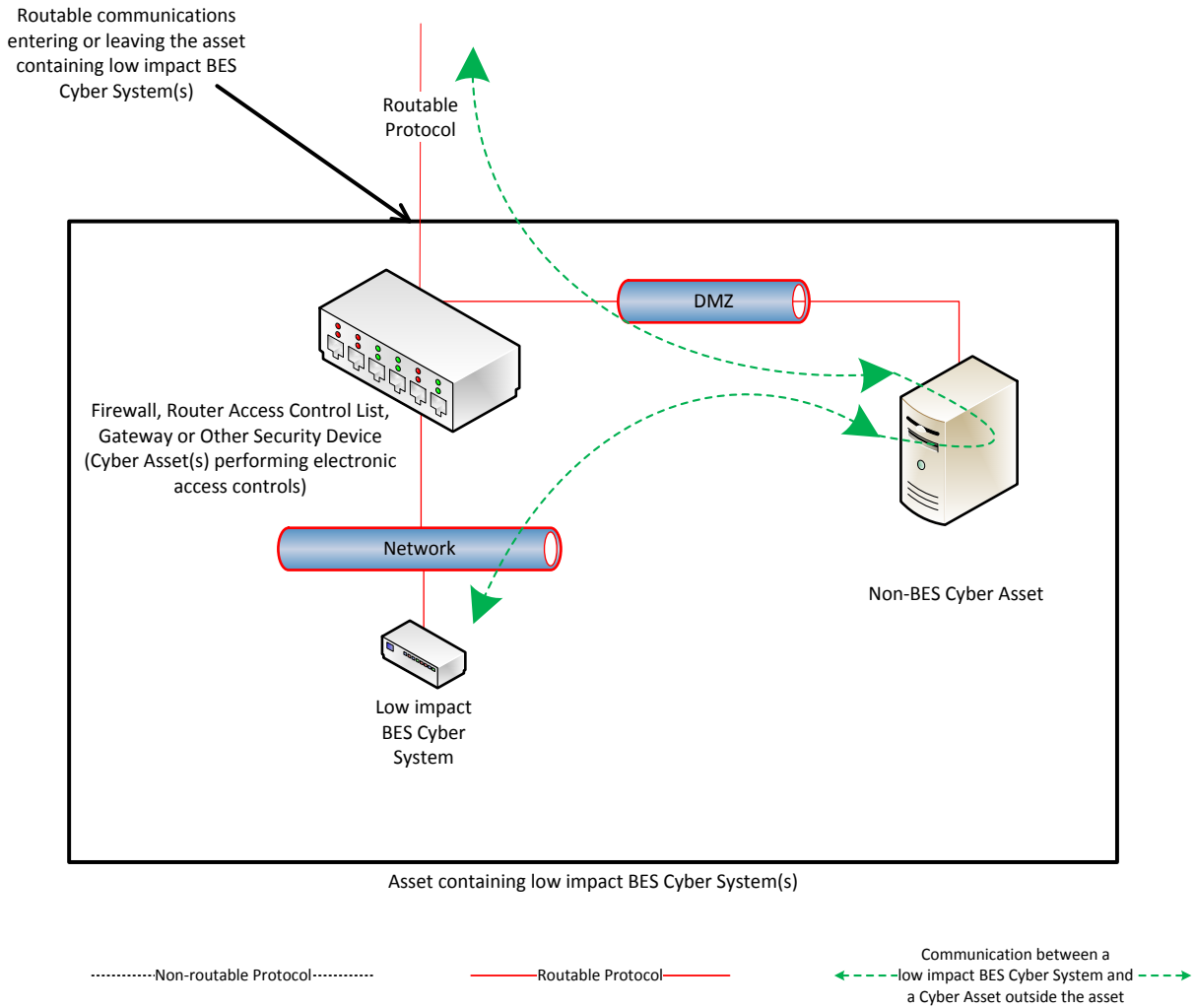

Reference Model 6

### Reference Model 7 – Electronic Access Controls at assets containing low impact BES Cyber Systems and ERC

In this reference model, there is both a routable protocol entering and leaving the asset containing the low impact BES Cyber System(s) that is used by Cyber Asset(s) outside the asset and External Routable Connectivity because there is at least one medium impact BES Cyber System and one low impact BES Cyber System within the asset using the routable protocol communications. The Responsible Entity may choose to leverage an interface on the medium impact Electronic Access Control or Monitoring Systems (EACMS) to provide electronic access controls for purposes of CIP-003. The EACMS is therefore performing multiple functions – as a medium impact EACMS and as implementing electronic access controls for an asset containing low impact BES Cyber Systems.

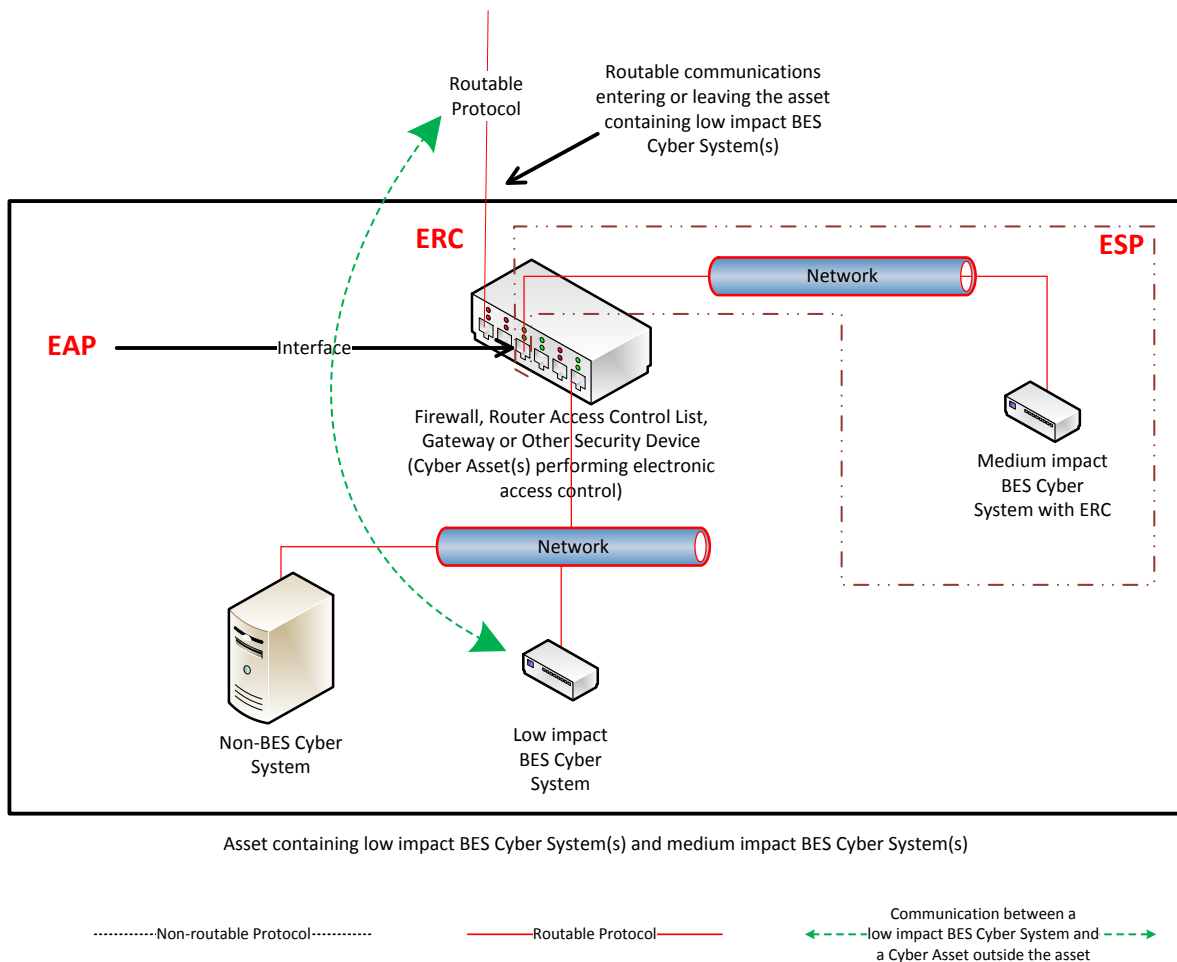

Reference Model 7

**Reference Model 8 – Physical Isolation and Serial Non-routable Communications – No Electronic Access Controls Required**

In this reference model, the criteria from Attachment 1, Section 3.1 requiring the implementation of electronic access controls are not met. This reference model demonstrates three concepts:

- 1) The physical isolation of the low impact BES Cyber System(s) from the routable protocol communication entering or leaving the asset containing the low impact BES Cyber System(s), commonly referred to as an 'air gap', mitigates the need to implement the required electronic access controls;
- 2) The communication to the low impact BES Cyber System from a Cyber Asset outside the asset containing the low impact BES Cyber System(s) using only a serial non-routable protocol where such communication is entering or leaving the asset mitigates the need to implement the required electronic access controls.
- 3) The routable protocol communication between the low impact BES Cyber System(s) and other Cyber Asset(s), such as the second low impact BES Cyber System depicted, may exist without needing to implement the required electronic access controls so long as the routable protocol communications never leaves the asset containing the low impact BES Cyber System(s).

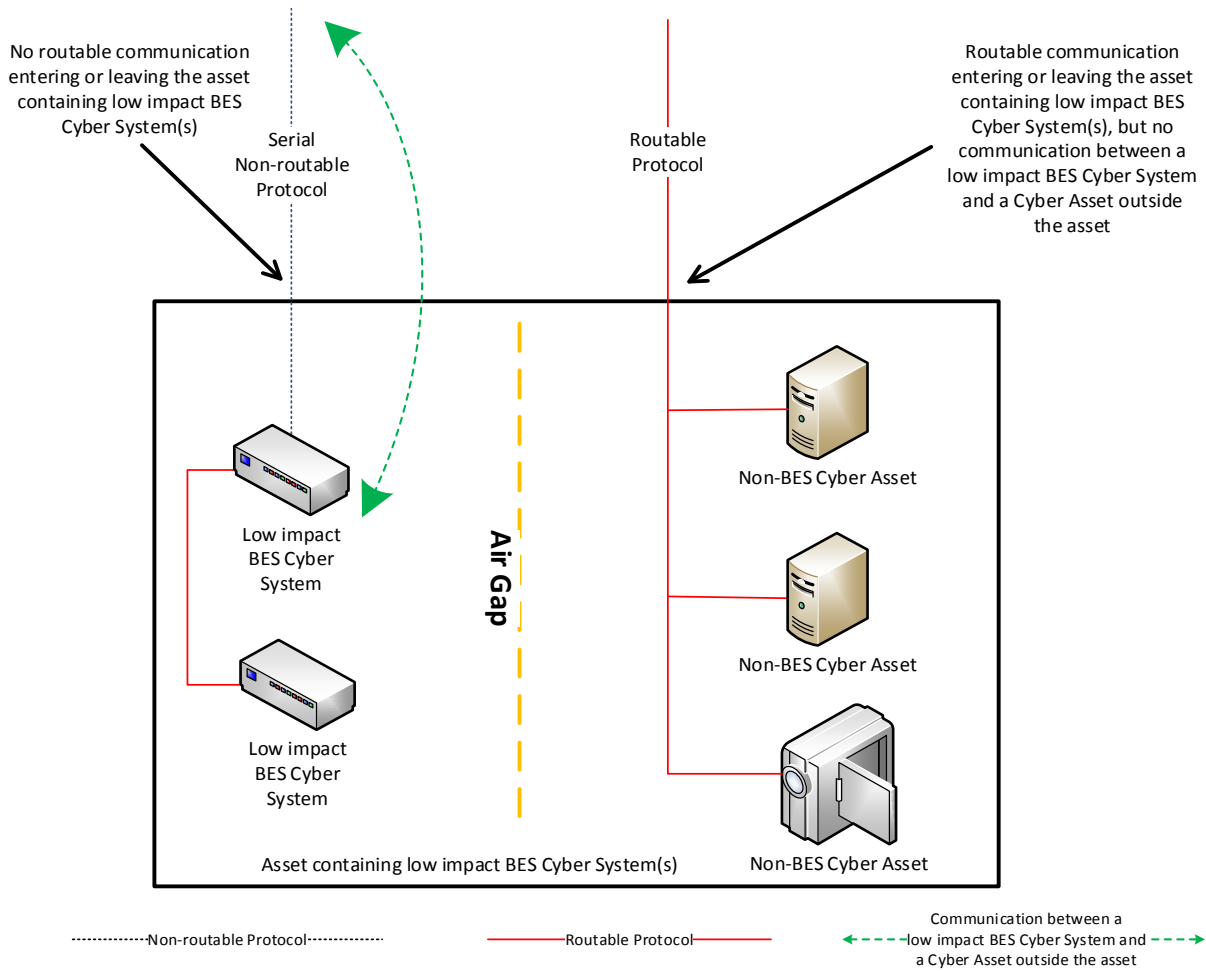

Reference Model 8

**Reference Model 9 – Logical Isolation - No Electronic Access Controls Required**

In this reference model, the criteria from Attachment 1, Section 3.1 requiring the implementation of electronic access controls are not met. The Responsible Entity has logically isolated the low impact BES Cyber System(s) from the routable protocol communication entering or leaving the asset containing low impact BES Cyber System(s). The logical network segmentation in this reference model permits no communication between a low impact BES Cyber System and a Cyber Asset outside the asset. Additionally, no indirect access exists because those non-BES Cyber Assets that are able to communicate outside the asset are strictly prohibited from communicating to the low impact BES Cyber System(s). The low impact BES Cyber System(s) is on an isolated network segment with logical controls preventing routable protocol communication into or out of the network containing the low impact BES Cyber System(s) and these communications never leave the asset using a routable protocol.

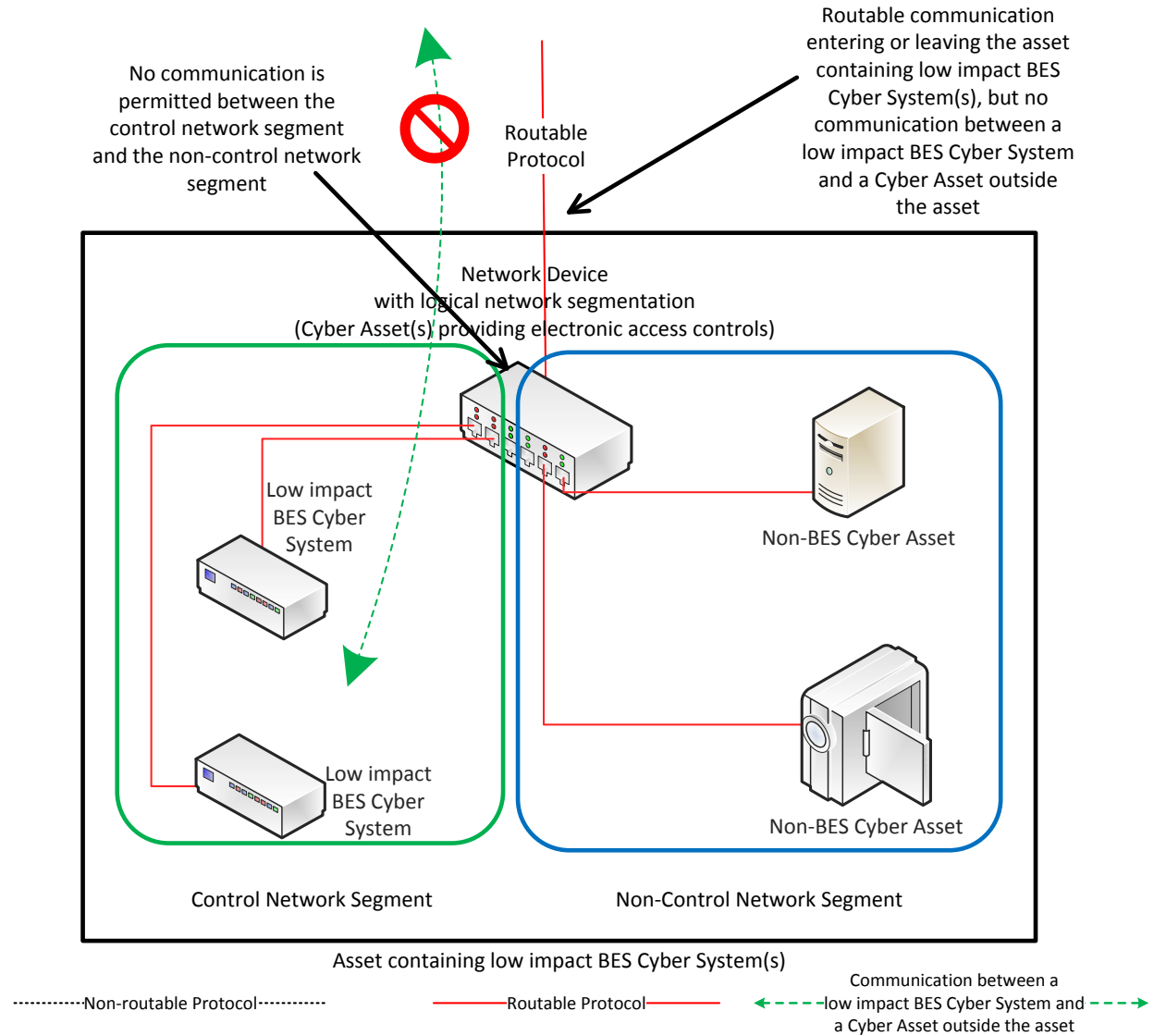

Reference Model 9

**Reference Model 10 - Serial Non-routable Communications Traversing an Isolated Channel on a Non-routable Transport Network – No Electronic Access Controls Required**

In this reference model, the criteria from Attachment 1, Section 3.1 requiring the implementation of electronic access controls are not met. This reference model depicts communication between a low impact BES Cyber System and a Cyber Asset outside the asset containing the low impact BES Cyber System over a serial non-routable protocol which is transported across a wide-area network using a protocol independent transport that may carry routable and non-routable communication such as a Time-Division Multiplexing (TDM) network, a Synchronous Optical Network (SONET), or a Multiprotocol Label Switching (MPLS) network. While there is routable protocol communication entering or leaving the asset containing low impact BES Cyber Systems(s) and there is communication between a low impact BES Cyber System and a Cyber Asset outside the asset, the communication between the low impact BES Cyber System and the Cyber Asset outside the asset is not using the routable protocol communication. This model is related to Reference Model 9 in that it relies on logical isolation to prohibit the communication between a low impact BES Cyber System and a Cyber Asset outside the asset from using a routable protocol.

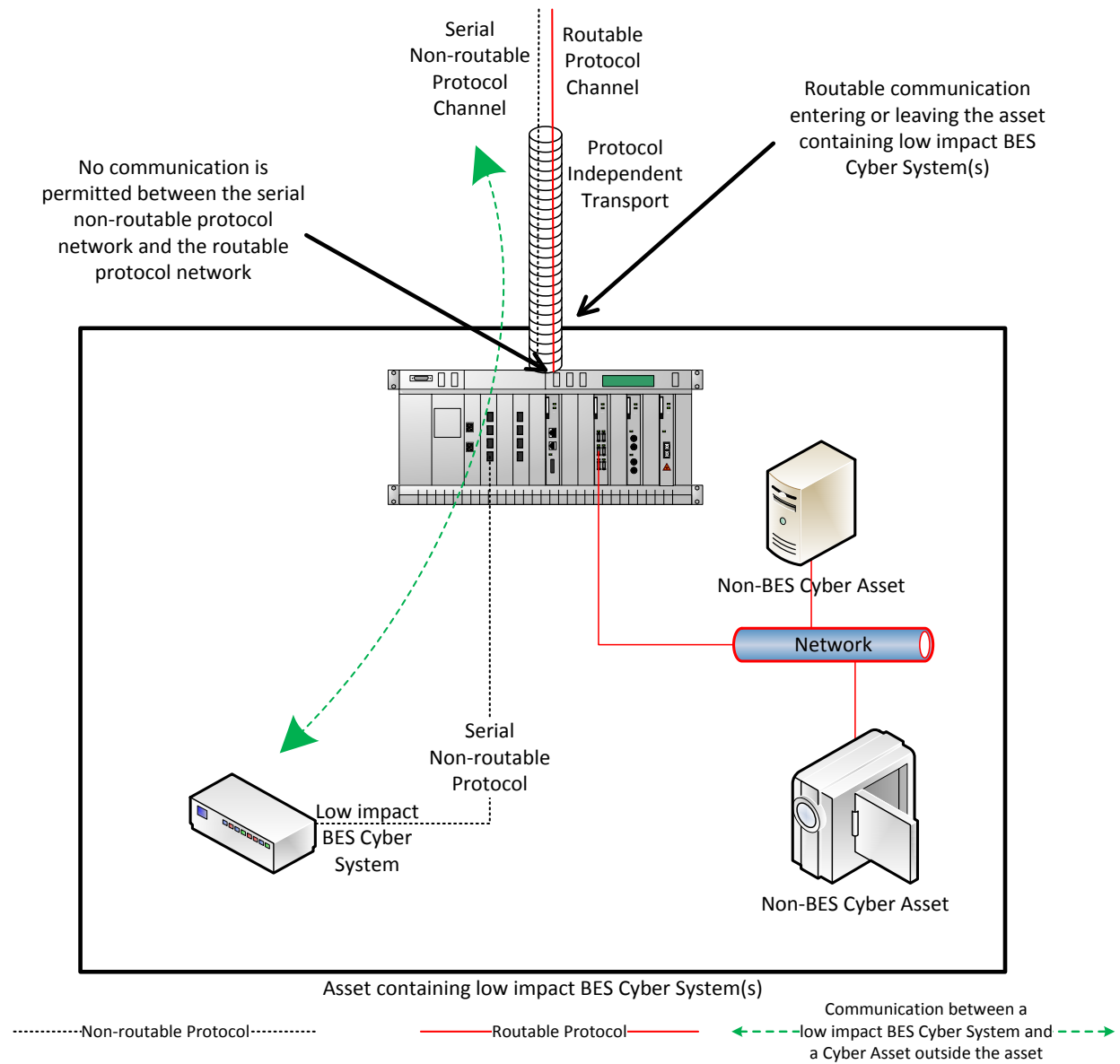

Reference Model 10



### **Dial-up Connectivity**

Dial-up Connectivity to a low impact BES Cyber System is set to dial out only (no auto-answer) to a preprogrammed number to deliver data. Incoming Dial-up Connectivity is to a dialback modem, a modem that must be remotely controlled by the control center or control room, has some form of access control, or the low impact BES Cyber System has access control.

### **Insufficient Access Controls**

Some examples of situations that would lack sufficient access controls to meet the intent of this requirement include:

- An asset has Dial-up Connectivity and a low impact BES Cyber System is reachable via an auto-answer modem that connects any caller to the Cyber Asset that has a default password. There is no practical access control in this instance.
- A low impact BES Cyber System has a wireless card on a public carrier that allows the BES Cyber System to be reachable via a public IP address. In essence, low impact BES Cyber Systems should not be accessible from the Internet and search engines such as Shodan.
- Dual-homing or multiple-network interface cards without disabling IP forwarding in the non-BES Cyber Asset within the DMZ to provide separation between the low impact BES Cyber System(s) and the external network would not meet the intent of “controlling” inbound and outbound electronic access assuming there was no other host-based firewall or other security devices on the non-BES Cyber Asset.

### **Requirement R2, Attachment 1, Section 4 – Cyber Security Incident Response**

The entity should have one or more documented Cyber Security Incident response plan(s) that include each of the topics listed in Section 4. If, in the normal course of business, suspicious activities are noted at an asset containing low impact BES Cyber System(s), the intent is for the entity to implement a Cyber Security Incident response plan that will guide the entity in responding to the incident and reporting the incident if it rises to the level of a Reportable Cyber Security Incident.

Entities are provided the flexibility to develop their Attachment 1, Section 4 Cyber Security Incident response plan(s) by asset or group of assets. The plans do not need to be on a per asset site or per low impact BES Cyber System basis. Entities can choose to use a single enterprise-wide plan to fulfill the obligations for low impact BES Cyber Systems.

The plan(s) must be tested once every 36 months. This is not an exercise per low impact BES Cyber Asset or per type of BES Cyber Asset but rather is an exercise of each incident response plan the entity created to meet this requirement. An actual Reportable Cyber Security Incident counts as an exercise as do other forms of tabletop exercises or drills. NERC-led exercises such as GridEx participation would also count as an exercise provided the entity’s response plan is followed. The intent of the requirement is for entities to keep the Cyber Security Incident response plan(s) current, which includes updating the plan(s), if needed, within 180 days following a test or an actual incident.

For low impact BES Cyber Systems, the only portion of the definition of Cyber Security Incident that would apply is, “A malicious act or suspicious event that disrupts, or was an attempt to

disrupt, the operation of a BES Cyber System.” The other portion of that definition is not to be used to require ESPs and PSPs for low impact BES Cyber Systems.

**Requirement R2, Attachment 1, Section 5 – Transient Cyber Assets and Removable Media Malicious Code Risk Mitigation**

Most BES Cyber Assets and BES Cyber Systems are isolated from external public or untrusted networks, and therefore Transient Cyber Assets and Removable Media are needed to transport files to and from secure areas to maintain, monitor, or troubleshoot critical systems. Transient Cyber Assets and Removable Media are a potential means for cyber-attack. To protect the BES Cyber Assets and BES Cyber Systems, CIP-003 Requirement R2, Attachment 1, Section 5 requires Responsible Entities to document and implement a plan for how they will mitigate the risk of malicious code introduction to low impact BES Cyber Systems from Transient Cyber Assets and Removable Media. The approach of defining a plan allows the Responsible Entity to document processes that are supportable within its organization and in alignment with its change management processes.

Transient Cyber Assets can be one of many types of devices from a specially-designed device for maintaining equipment in support of the BES to a platform such as a laptop, desktop, or tablet that may interface with or run applications that support BES Cyber Systems and is capable of transmitting executable code to the BES Cyber Asset(s) or BES Cyber System(s). Note: Cyber Assets connected to a BES Cyber System for less than 30 days due to an unplanned removal, such as premature failure, are not intended to be identified as Transient Cyber Assets. Removable Media subject to this requirement include, among others, floppy disks, compact disks, USB flash drives, external hard drives, and other flash memory cards/drives that contain nonvolatile memory.

Examples of these temporarily connected devices include, but are not limited to:

- Diagnostic test equipment;
- Equipment used for BES Cyber System maintenance; or
- Equipment used for BES Cyber System configuration.

To meet the objective of mitigating risks associated with the introduction of malicious code at low impact BES Cyber Systems, Section 5 specifies the capabilities and possible security methods available to Responsible Entities based upon asset type and ownership.

With the list of options provided in Attachment 1, the entity has the discretion to use the option(s) that is most appropriate. This includes documenting its approach for how and when the entity reviews the Transient Cyber Asset under its control or under the control of parties other than the Responsible Entity. The entity should avoid implementing a security function that jeopardizes reliability by taking actions that would negatively impact the performance or support of the Transient Cyber Asset or BES Cyber Asset.

### Malicious Code Risk Mitigation

The terms “mitigate”, “mitigating”, and “mitigation” are used in Section 5 in Attachment 1 to address the risks posed by malicious code when connecting Transient Cyber Assets and Removable Media to BES Cyber Systems. Mitigation is intended to mean that entities reduce security risks presented by connecting the Transient Cyber Asset or Removable Media. When determining the method(s) to mitigate the introduction of malicious code, it is not intended for entities to perform and document a formal risk assessment associated with the introduction of malicious code.

### Per Transient Cyber Asset Capability

As with other CIP standards, the requirements are intended for an entity to use the method(s) that the system is capable of performing. The use of “per Transient Cyber Asset capability” is to eliminate the need for a Technical Feasibility Exception when it is understood that the device cannot use a method(s). For example, for malicious code, many types of appliances are not capable of implementing antivirus software; therefore, because it is not a capability of those types of devices, implementation of the antivirus software would not be required for those devices.

### **Requirement R2, Attachment 1, Section 5.1 - Transient Cyber Asset(s) Managed by the Responsible Entity**

For Transient Cyber Assets and Removable Media that are connected to both low impact and medium/high impact BES Cyber Systems, entities must be aware of the differing levels of requirements and manage these assets under the program that matches the highest impact level to which they will connect.

**Section 5.1:** Entities are to document and implement their plan(s) to mitigate malicious code through the use of one or more of the protective measures listed, based on the capability of the Transient Cyber Asset.

The Responsible Entity has the flexibility to apply the selected method(s) to meet the objective of mitigating the introductions of malicious code either in an on-going or in an on-demand manner. An example of managing a device in an on-going manner is having the antivirus solution for the device managed as part of an end-point security solution with current signature or pattern updates, regularly scheduled systems scans, etc. In contrast, for devices that are used infrequently and the signatures or patterns are not kept current, the entity may manage those devices in an on-demand manner by requiring an update to the signatures or patterns and a scan of the device before the device is connected to ensure that it is free of malicious code.

Selecting management in an on-going or on-demand manner is not intended to imply that the control has to be verified at every single connection. For example, if the device is managed in an on-demand manner, but will be used to perform maintenance on several BES Cyber Asset(s), the Responsible Entity may choose to document that the Transient Cyber Asset has been updated before being connected as a Transient Cyber Asset for the first use of that maintenance work. The intent is not to require a log documenting each connection of a Transient Cyber Asset to a BES Cyber Asset.

The following is additional discussion of the methods to mitigate the introduction of malicious code.

- Antivirus software, including manual or managed updates of signatures or patterns, provides flexibility to manage Transient Cyber Asset(s) by deploying antivirus or endpoint security tools that maintain a scheduled update of the signatures or patterns. Also, for devices that do not regularly connect to receive scheduled updates, entities may choose to update the signatures or patterns and scan the Transient Cyber Asset prior to connection to ensure no malicious software is present.
- Application whitelisting is a method of authorizing only the applications and processes that are necessary on the Transient Cyber Asset. This reduces the risk that malicious software could execute on the Transient Cyber Asset and impact the BES Cyber Asset or BES Cyber System.
- When using methods other than those listed, entities need to document how the other method(s) meet the objective of mitigating the risk of the introduction of malicious code.

If malicious code is discovered on the Transient Cyber Asset, it must be mitigated prior to connection to a BES Cyber System to prevent the malicious code from being introduced into the BES Cyber System. An entity may choose to not connect the Transient Cyber Asset to a BES Cyber System to prevent the malicious code from being introduced into the BES Cyber System. Entities should also consider whether the detected malicious code is a Cyber Security Incident.

**Requirement R2, Attachment 1, Section 5.2 - Transient Cyber Asset(s) Managed by a Party Other than the Responsible Entity**

Section 5 also recognizes the lack of direct control over Transient Cyber Assets that are managed by parties other than the Responsible Entity. This lack of control, however, does not obviate the Responsible Entity's responsibility to ensure that methods have been deployed to mitigate the introduction of malicious code to low impact BES Cyber System(s) from Transient Cyber Assets it does not manage. Section 5 requires entities to review the other party's security practices with respect to Transient Cyber Assets to help meet the objective of the requirement. The use of "prior to connecting the Transient Cyber Assets" is intended to ensure that the Responsible Entity conducts the review before the first connection of the Transient Cyber Asset to help meet the objective to mitigate the introduction of malicious code. The SDT does not intend for the Responsible Entity to conduct a review for every single connection of that Transient Cyber Asset once the Responsible Entity has established the Transient Cyber Asset is meeting the security objective. The intent is to not require a log documenting each connection of a Transient Cyber Asset to a BES Cyber Asset.

To facilitate these controls, Responsible Entities may execute agreements with other parties to provide support services to BES Cyber Systems and BES Cyber Assets that may involve the use of Transient Cyber Assets. Entities may consider using the Department of Energy Cybersecurity Procurement Language for Energy Delivery dated April 2014.<sup>1</sup> Procurement language may unify

---

<sup>1</sup> <http://www.energy.gov/oe/downloads/cybersecurity-procurement-language-energy-delivery-april-2014>

the other party and entity actions supporting the BES Cyber Systems and BES Cyber Assets. CIP program attributes may be considered including roles and responsibilities, access controls, monitoring, logging, vulnerability, and patch management along with incident response and back up recovery may be part of the other party's support. Entities may consider the "General Cybersecurity Procurement Language" and "The Supplier's Life Cycle Security Program" when drafting Master Service Agreements, Contracts, and the CIP program processes and controls.

**Section 5.2.1:** Entities are to document and implement their process(es) to mitigate the introduction of malicious code through the use of one or more of the protective measures listed.

- Review the use of antivirus software and signature or pattern levels to ensure that the level is adequate to the Responsible Entity to mitigate the risk of malicious software being introduced to an applicable system.
- Review the antivirus or endpoint security processes of the other party to ensure that their processes are adequate to the Responsible Entity to mitigate the risk of introducing malicious software to an applicable system.
- Review the use of application whitelisting used by the other party to mitigate the risk of introducing malicious software to an applicable system.
- Review the use of live operating systems or software executable only from read-only media to ensure that the media is free from malicious software itself. Entities should review the processes to build the read-only media as well as the media itself.
- Review system hardening practices used by the other party to ensure that unnecessary ports, services, applications, etc. have been disabled or removed. This method intends to reduce the attack surface on the Transient Cyber Asset and reduce the avenues by which malicious software could be introduced.

**Section 5.2.2:** The intent of this section is to ensure that after conducting the selected review from Section 5.2.1, if there are deficiencies identified, actions mitigating the risk of the introduction of malicious code to low impact BES Cyber Systems must be completed prior to connecting the device(s) to an -applicable system.

### **Requirement R2, Attachment 1, Section 5.3 - Removable Media**

Entities have a high level of control for Removable Media that are going to be connected to their BES Cyber Assets.

**Section 5.3:** Entities are to document and implement their process(es) to mitigate the introduction of malicious code through the use of one or more method(s) to detect malicious code on the Removable Media before it is connected to a BES Cyber Asset. When using the method(s) to detect malicious code, it is expected to occur from a system that is not part of the

BES Cyber System to reduce the risk of propagating malicious code into the BES Cyber System network or onto one of the BES Cyber Assets. If malicious code is discovered, it must be removed or mitigated to prevent it from being introduced into the BES Cyber Asset or BES Cyber System. Entities should also consider whether the detected malicious code is a Cyber Security Incident. Frequency and timing of the methods used to detect malicious code were intentionally excluded from the requirement because there are multiple timing scenarios that can be incorporated into a plan to mitigate the risk of malicious code. The SDT does not intend to obligate a Responsible Entity to conduct a review for every single connection of Removable Media, but rather to implement its plan(s) in a manner that protects all BES Cyber Systems where Removable Media may be used. The intent is to not require a log documenting each connection of Removable Media to a BES Cyber Asset.

As a method to detect malicious code, entities may choose to use Removable Media with on-board malicious code detection tools. For these tools, the Removable Media are still used in conjunction with a Cyber Asset to perform the detection. For Section 5.3.1, the Cyber Asset used to perform the malicious code detection must be outside of the BES Cyber System.

### **Requirement R3:**

The intent of CIP-003-~~87~~, Requirement R3 is effectively unchanged since prior versions of the standard. The specific description of the CIP Senior Manager has now been included as a defined term rather than clarified in the Reliability Standard itself to prevent any unnecessary cross-reference to this standard. It is expected that the CIP Senior Manager will play a key role in ensuring proper strategic planning, executive/board-level awareness, and overall program governance.

### **Requirement R4:**

As indicated in the rationale for CIP-003-~~87~~, Requirement R4, this requirement is intended to demonstrate a clear line of authority and ownership for security matters. The intent of the SDT was not to impose any particular organizational structure, but, rather, the intent is to afford the Responsible Entity significant flexibility to adapt this requirement to its existing organizational structure. A Responsible Entity may satisfy this requirement through a single delegation document or through multiple delegation documents. The Responsible Entity can make use of the delegation of the delegation authority itself to increase the flexibility in how this applies to its organization. In such a case, delegations may exist in numerous documentation records as long as the collection of these documentation records shows a clear line of authority back to the CIP Senior Manager. In addition, the CIP Senior Manager could also choose not to delegate any authority and meet this requirement without such delegation documentation.

The Responsible Entity must keep its documentation of the CIP Senior Manager and any delegations up-to-date. This is to ensure that individuals do not assume any undocumented authority. However, delegations do not have to be re-instated if the individual who delegated the task changes roles or the individual is replaced. For instance, assume that John Doe is named the CIP Senior Manager and he delegates a specific task to the Substation Maintenance Manager. If John Doe is replaced as the CIP Senior Manager, the CIP Senior Manager documentation must be updated within the specified timeframe, but the existing delegation to

the Substation Maintenance Manager remains in effect as approved by the previous CIP Senior Manager, John Doe.



**Rationale:**

During development of this standard, text boxes were embedded within the standard to explain the rationale for various parts of the standard. Upon BOT approval, the text from the rationale text boxes was moved to this section.

**Rationale for Requirement R1:**

One or more security policies enable effective implementation of the requirements of the cyber security Reliability Standards. The purpose of policies is to provide a management and governance foundation for all requirements that apply to a Responsible Entity's BES Cyber Systems. The Responsible Entity can demonstrate through its policies that its management supports the accountability and responsibility necessary for effective implementation of the requirements.

Annual review and approval of the cyber security policies ensures that the policies are kept-up-to-date and periodically reaffirms management's commitment to the protection of its BES Cyber Systems.

**Rationale for Requirement R2:**

In response to FERC Order No. 791, Requirement R2 requires entities to develop and implement cyber security plans to meet specific security control objectives for assets containing low impact BES Cyber System(s). The cyber security plan(s) covers five subject matter areas: (1) cyber security awareness; (2) physical security controls; (3) electronic access controls; (4) Cyber Security Incident response; and (5) Transient Cyber Asset and Removable Media Malicious Code Risk Mitigation. This plan(s), along with the cyber security policies required under Requirement R1, Part 1.2, provides a framework for operational, procedural, and technical safeguards for low impact BES Cyber Systems.

Considering the varied types of low impact BES Cyber Systems across the BES, Attachment 1 provides Responsible Entities flexibility on how to apply the security controls to meet the security objectives. Additionally, because many Responsible Entities have multiple-impact rated BES Cyber Systems, nothing in the requirement prohibits entities from using their high and medium impact BES Cyber System policies, procedures, and processes to implement security controls required for low impact BES Cyber Systems, as detailed in Requirement R2, Attachment 1.

Responsible Entities will use their identified assets containing low impact BES Cyber System(s) (developed pursuant to CIP-002) to substantiate the sites or locations associated with low impact BES Cyber System(s). However, there is no requirement or compliance expectation for Responsible Entities to maintain a list(s) of individual low impact BES Cyber System(s) and their associated cyber assets or to maintain a list of authorized users.

**Rationale for Modifications to Sections 2 and 3 of Attachment 1 (Requirement R2):**

Requirement R2 mandates that entities develop and implement one or more cyber security plan(s) to meet specific security objectives for assets containing low impact BES Cyber System(s). In Paragraph 73 of FERC Order No. 822, the Commission directed NERC to modify "...the Low Impact External Routable Connectivity definition to reflect the commentary in the Guidelines and Technical Basis section of CIP-003-6...to provide needed clarity to the definition



and eliminate ambiguity surrounding the term ‘direct’ as it is used in the proposed definition...within one year of the effective date of this Final Rule.”

The revisions to Section 3 incorporate select language from the LERC definition into Attachment 1 and focus the requirement on implementing electronic access controls for asset(s) containing low impact BES Cyber System(s). This change requires the Responsible Entity to permit only necessary inbound and outbound electronic access when using a routable protocol entering or leaving the asset between low impact BES Cyber System(s) and a Cyber Asset(s) outside the asset containing low impact BES Cyber system(s). When this communication is present, Responsible Entities are required to implement electronic access controls unless that communication meets the following exclusion language (previously in the definition of LERC) contained in romanette (iii): “not used for time-sensitive protection or control functions between intelligent electronic devices (e.g. communications using protocol IEC TR-61850-90-5 R-GOOSE)”.

The revisions to Section 2 of Attachment 1 complement the revisions to Section 3; consequently, the requirement now mandates the Responsible Entity control physical access to “the Cyber Asset(s), as specified by the Responsible Entity, that provide electronic access control(s) implemented for Section 3.1, if any.” The focus on electronic access controls rather than on the Low Impact BES Cyber System Electronic Access Points (LEAPs) eliminates the need for LEAPs.

Given these revisions to Sections 2 and 3, the NERC Glossary terms: Low Impact External Routable Connectivity (LERC) and Low Impact BES Cyber System Electronic Access Point (LEAP) will be retired.

**Rationale for Section 5 of Attachment 1 (Requirement R2):**

Requirement R2 mandates that entities develop and implement one or more cyber security plan(s) to meet specific security objectives for assets containing low impact BES Cyber System(s). In Paragraph 32 of FERC Order No. 822, the Commission directed NERC to “...provide mandatory protection for transient devices used at Low Impact BES Cyber Systems based on the risk posed to bulk electric system reliability.” Transient devices are potential vehicles for introducing malicious code into low impact BES Cyber Systems. Section 5 of Attachment 1 is intended to mitigate the risk of malware propagation to the BES through low impact BES Cyber Systems by requiring entities to develop and implement one or more plan(s) to address the risk. The cyber security plan(s) along with the cyber security policies required under Requirement R1, Part 1.2, provide a framework for operational, procedural, and technical safeguards for low impact BES Cyber Systems.

**Rationale for Requirement R3:**

The identification and documentation of the single CIP Senior Manager ensures that there is clear authority and ownership for the CIP program within an organization, as called for in Blackout Report Recommendation 43. The language that identifies CIP Senior Manager responsibilities is included in the Glossary of Terms used in NERC Reliability Standards so that it may be used across the body of CIP standards without an explicit cross-reference.

FERC Order No. 706, Paragraph 296, requests consideration of whether the single senior manager should be a corporate officer or equivalent. As implicated through the defined term, the senior manager has “the overall authority and responsibility for leading and managing implementation of the requirements within this set of standards” which ensures that the senior manager is of sufficient position in the Responsible Entity to ensure that cyber security receives the prominence that is necessary. In addition, given the range of business models for responsible entities, from municipal, cooperative, federal agencies, investor owned utilities, privately owned utilities, and everything in between, the SDT believes that requiring the CIP Senior Manager to be a “corporate officer or equivalent” would be extremely difficult to interpret and enforce on a consistent basis.

**Rationale for Requirement R4:**

The intent of the requirement is to ensure clear accountability within an organization for certain security matters. It also ensures that delegations are kept up-to-date and that individuals do not assume undocumented authority.

In FERC Order No. 706, Paragraphs 379 and 381, the Commission notes that Recommendation 43 of the 2003 Blackout Report calls for “clear lines of authority and ownership for security matters.” With this in mind, the Standard Drafting Team has sought to provide clarity in the requirement for delegations so that this line of authority is clear and apparent from the documented delegations.

## Implementation Plan

### Project 2016-02 Modifications to CIP Standards Reliability Standard CIP-003-8 - Cyber Security – Security Management Controls

#### Applicable Standard

- Reliability Standard CIP-003-8 - Cyber Security – Security Management Controls

#### Requested Retirements

- Reliability Standard CIP-003-7 - Cyber Security – Security Management Controls

#### Applicable Entities

- Balancing Authority
- Distribution Provider
- Generator Operator
- Generator Owner
- Reliability Coordinator
- Transmission Operator
- Transmission Owner

#### Background

On April 19, 2018, the Federal Energy Regulatory Commission (the “Commission”) issued Order No. 843, approving CIP-003-7. In that Order, the Commission also directed NERC to “develop and submit modifications to Reliability Standard CIP-003-7 to include an explicit requirement that responsible entities implement controls to mitigate the risk of malicious code that could result from third-party transient electronic devices.”

#### Effective Dates

##### Reliability Standard CIP-003-8

Where approval by an applicable governmental authority is required, Reliability Standard CIP-003-8 shall become effective on the later of (1) January 1, 2020, or (2) the first day of the first calendar quarter that is six (6) calendar months after the effective date of the applicable governmental authority’s order approving the standard, or as otherwise provided for by the applicable governmental authority.

Where approval by an applicable governmental authority is not required, Reliability Standard CIP-003-8 shall become effective on the later of (1) January 1, 2020, or (2) the first day of the first

calendar quarter that is six (6) calendar months after the date the standard is adopted by the NERC Board of Trustees, or as otherwise provided for in that jurisdiction.

### **Retirement Date**

#### **Reliability Standard CIP-003-7**

Reliability Standard CIP-003-7 shall be retired immediately prior to the effective date of Reliability Standard CIP-003-8 in the particular jurisdiction in which the revised standard is becoming effective.

# Unofficial Comment Form

## Project 2016-02 Modifications to CIP Standards

### CIP-003-8

**Do not** use this form for submitting comments. Use the [Standards Balloting and Commenting System](#) to submit comments on **CIP-003-8 - Cyber Security – Security Management Controls (FERC Order No. 843 – Third Party TCA)**. Comments must be submitted by **8 p.m. Eastern, Tuesday, October 9, 2018**.

Additional information is available on the [project page](#). If you have questions, contact Standards Developer, [Jordan Mallory](#) (via email) or at 404-446-2589.

#### Background Information

On April 19, 2018, the Commission issued Order No. 843, approving CIP-003-7 and directing a modification to CIP-003-7 related to the mitigation of risk associated with the use of third-party transient electronic devices. The Commission directed NERC to “develop and submit modifications to Reliability Standard CIP-003-7 to include an explicit requirement that Responsible Entities implement controls to mitigate the risk of malicious code that could result from third-party transient electronic devices.”

#### SDT Approach

The Project 2016-02 Standard Drafting Team (SDT) revised Reliability Standard CIP-003-7 to require Responsible Entities to determine whether additional mitigation is necessary to address the risk of the introduction of malicious code to low impact BES Cyber Systems when using third-party Transient Cyber Assets. The revision also requires that Responsible Entities implement any mitigation prior to connecting the Transient Cyber Asset. The SDT based this additional determination and implementation step for third-party Transient Cyber Assets on the currently approved language in CIP-010-2, Attachment 1 for the use of Transient Cyber Assets with high and medium impact BES Cyber Systems.

#### Questions

1. Requirement R2, Attachment 1, Section 5.2: In response to the directive in FERC Order 843, the SDT modified Attachment 1, Section 5.2 adding subsection 5.2.2 to state: “For any method used pursuant to 5.2.1, Responsible Entities shall determine whether any additional mitigation actions are necessary and implement such actions prior to connecting the Transient Cyber Asset.” Do you agree with this revision? If not, please provide the basis for your disagreement and an alternate proposal.

Yes

No

Comments:

2. Guidelines and Technical Basis: The SDT made changes to the Guidelines and Technical Basis section of the Standard to conform with the modifications it made to Attachment 1, Section 5.2. Do you agree with these changes to the Guidelines and Technical Basis? If not, please provide the basis for your disagreement and an alternate proposal. (The CIP SDT is aware that another initiative is underway to convert all GTB sections to Technical Rationale documents. This effort is outside the scope of this SDT.)

- Yes  
 No

Comments:

3. Implementation Plan: The SDT established the Implementation Plan to make the standard effective the later of (1) January 1, 2020, or (2) the first day of the first calendar quarter that is six (6) calendar months after the effective date of the applicable governmental authority's order approving the standard, or as otherwise provided for by the applicable governmental authority. Do you agree with this proposal? If you think an alternate effective date is needed, please provide a detailed explanation of actions and time needed.

- Yes  
 No

Comments:

4. The SDT believes proposed modifications in CIP-003-8 provide entities with flexibility to meet the reliability objectives in a cost effective manner. Do you agree? If you do not agree, or if you agree but have suggestions for improvement to enable more cost effective approaches, please provide your recommendation and, if appropriate, technical or procedural justification.

- Yes  
 No

Comments:

# Violation Risk Factor and Violation Severity Level Justifications

## Project 2016-02 – Modifications to CIP Standards

This document provides the standard drafting team's (SDT's) justification for assignment of the violation risk factor (VRF) and violation severity levels (VSLs) for Requirements R1 and R2 in proposed NERC Reliability Standard CIP-003-8 — Cyber Security — Security Management Controls. These elements support the determination of an initial value range for the Base Penalty Amount regarding violations of requirements in FERC-approved Reliability Standards, as defined in the Electric Reliability Organizations (ERO) Sanction Guidelines. The SDT applied the following NERC criteria and FERC Guidelines when developing the VRFs and VSLs for the requirements.

### NERC Criteria for Violation Risk Factors

#### High Risk Requirement

A requirement that, if violated, could directly cause or contribute to Bulk Electric System instability, separation, or a cascading sequence of failures, or could place the Bulk Electric System at an unacceptable risk of instability, separation, or cascading failures; or, a requirement in a planning time frame that, if violated, could, under emergency, abnormal, or restorative conditions anticipated by the preparations, directly cause or contribute to Bulk Electric System instability, separation, or a cascading sequence of failures, or could place the Bulk Electric System at an unacceptable risk of instability, separation, or cascading failures, or could hinder restoration to a normal condition.

#### Medium Risk Requirement

A requirement that, if violated, could directly affect the electrical state or the capability of the Bulk Electric System, or the ability to effectively monitor and control the Bulk Electric System. However, violation of a medium risk requirement is unlikely to lead to Bulk Electric System instability, separation, or cascading failures; or, a requirement in a planning time frame that, if violated, could, under emergency, abnormal, or restorative conditions anticipated by the preparations, directly and adversely affect the electrical state or capability of the Bulk Electric System, or the ability to effectively monitor, control, or restore the Bulk Electric System. However, violation of a medium risk requirement is unlikely, under emergency, abnormal, or restoration conditions anticipated by the preparations, to lead to Bulk Electric System instability, separation, or cascading failures, nor to hinder restoration to a normal condition.

### **Lower Risk Requirement**

A requirement that is administrative in nature and a requirement that, if violated, would not be expected to adversely affect the electrical state or capability of the Bulk Electric System, or the ability to effectively monitor and control the Bulk Electric System; or, a requirement that is administrative in nature and a requirement in a planning time frame that, if violated, would not, under the emergency, abnormal, or restorative conditions anticipated by the preparations, be expected to adversely affect the electrical state or capability of the Bulk Electric System, or the ability to effectively monitor, control, or restore the Bulk Electric System.

## **FERC Guidelines for Violation Risk Factors**

### **Guideline (1) – Consistency with the Conclusions of the Final Blackout Report**

FERC seeks to ensure that VRFs assigned to Requirements of Reliability Standards in these identified areas appropriately reflect their historical critical impact on the reliability of the Bulk-Power System. In the VSL Order, FERC listed critical areas (from the Final Blackout Report) where violations could severely affect the reliability of the Bulk-Power System:

- Emergency operations
- Vegetation management
- Operator personnel training
- Protection systems and their coordination
- Operating tools and backup facilities
- Reactive power and voltage control
- System modeling and data exchange
- Communication protocol and facilities
- Requirements to determine equipment ratings
- Synchronized data recorders
- Clearer criteria for operationally critical facilities
- Appropriate use of transmission loading relief.



**Guideline (2) – Consistency within a Reliability Standard**

FERC expects a rational connection between the sub-Requirement VRF assignments and the main Requirement VRF assignment.

**Guideline (3) – Consistency among Reliability Standards**

FERC expects the assignment of VRFs corresponding to Requirements that address similar reliability goals in different Reliability Standards would be treated comparably.

**Guideline (4) – Consistency with NERC’s Definition of the Violation Risk Factor Level**

Guideline (4) was developed to evaluate whether the assignment of a particular VRF level conforms to NERC’s definition of that risk level.

**Guideline (5) – Treatment of Requirements that Co-mingle More Than One Obligation**

Where a single Requirement co-mingles a higher risk reliability objective and a lesser risk reliability objective, the VRF assignment for such Requirements must not be watered down to reflect the lower risk level associated with the less important objective of the Reliability Standard.

**NERC Criteria for Violation Severity Levels**

VSLs define the degree to which compliance with a requirement was not achieved. Each requirement must have at least one VSL. While it is preferable to have four VSLs for each requirement, some requirements do not have multiple “degrees” of noncompliant performance and may have only one, two, or three VSLs.

VSLs should be based on NERC’s overarching criteria shown in the table below:

Lower VSL	Moderate VSL	High VSL	Severe VSL
The performance or product measured almost meets the full intent of the requirement.	The performance or product measured meets the majority of the intent of the requirement.	The performance or product measured does not meet the majority of the intent of the requirement, but does meet some of the intent.	The performance or product measured does not substantively meet the intent of the requirement.

**FERC Order of Violation Severity Levels**

The FERC VSL guidelines are presented below, followed by an analysis of whether the VSLs proposed for each requirement in the standard meet the FERC Guidelines for assessing VSLs:

**Guideline (1) – Violation Severity Level Assignments Should Not Have the Unintended Consequence of Lowering the Current Level of Compliance**

Compare the VSLs to any prior levels of non-compliance and avoid significant changes that may encourage a lower level of compliance than was required when levels of non-compliance were used.

**Guideline (2) – Violation Severity Level Assignments Should Ensure Uniformity and Consistency in the Determination of Penalties**

A violation of a “binary” type requirement must be a “Severe” VSL.  
Do not use ambiguous terms such as “minor” and “significant” to describe noncompliant performance.

**Guideline (3) – Violation Severity Level Assignment Should Be Consistent with the Corresponding Requirement**

VSLs should not expand on what is required in the requirement.

#### **Guideline (4) – Violation Severity Level Assignment Should Be Based on A Single Violation, Not on A Cumulative Number of Violations**

Unless otherwise stated in the requirement, each instance of non-compliance with a requirement is a separate violation. Section 4 of the Sanction Guidelines states that assessing penalties on a per violation per day basis is the “default” for penalty calculations.

- **Requirement R1: No changes made to the VRF or VSL.**
- **Requirement R2: No changes made to the VRF or VSL.**
- **Requirement R3: No changes made to the VRF or VSL.**
- **Requirement R4: No changes made to the VRF or VSL.**

# Standards Announcement

## Project 2016-02 Modifications to CIP Standards

Formal Comment Period Open through **October 9, 2018**

Ballot Pools Forming through **September 21, 2018**

### [Now Available](#)

A 45-day formal comment period for **C CIP-002-6 - Cyber Security – BES Cyber System Categorization** and **CIP-003-8 - Cyber Security – Security Management Controls** is open through **8 p.m. Eastern, Tuesday, October 9, 2018**.

### Commenting

Use the [Standards Balloting and Commenting System \(SBS\)](#) to submit comments. If you experience difficulty using the SBS, contact [Wendy Muller](#). An unofficial Word version of the comment form is posted on the [project page](#).

### Ballot Pools

Ballot pools are being formed through **8 p.m. Eastern, Friday, September 21, 2018**. Registered Ballot Body members can join the ballot pools [here](#).

- *If you are having difficulty accessing the SBS due to a forgotten password, incorrect credential error messages, or system lock-out, contact NERC IT support directly at <https://support.nerc.net/> (Monday – Friday, 8 a.m. - 5 p.m. Eastern).*
- *Passwords expire every **6 months** and must be reset.*
- *The SBS **is not** supported for use on mobile devices.*
- *Please be mindful of ballot and comment period closing dates. We ask to **allow at least 48 hours** for NERC support staff to assist with inquiries. Therefore, it is recommended that users try logging into their SBS accounts **prior to the last day** of a comment/ballot period.*

### Next Steps

Initial ballots for the standard and non-binding polls of the associated Violation Risk Factors and Violation Severity Levels will be conducted **September 28 – October 9, 2018**.

For information on the Standards Development Process, refer to the [Standard Processes Manual](#).

For more information or assistance, contact Standards Developer, [Jordan Mallory](#) (via email) or at (404) 446-2589.

North American Electric Reliability Corporation  
3353 Peachtree Rd, NE  
Suite 600, North Tower  
Atlanta, GA 30326  
404-446-2560 | [www.nerc.com](http://www.nerc.com)

## BALLOT RESULTS

Comment: View Comment Results (/CommentResults/Index/152)

**Ballot Name:** 2016-02 Modifications to CIP Standards CIP-003-8 Draft 1 IN 1 ST

**Voting Start Date:** 9/28/2018 12:01:00 AM

**Voting End Date:** 10/9/2018 8:00:00 PM

**Ballot Type:** ST

**Ballot Activity:** IN

**Ballot Series:** 1

**Total # Votes:** 256

**Total Ballot Pool:** 324

**Quorum:** 79.01

**Weighted Segment Value:** 90.06

Segment	Ballot Pool	Segment Weight	Affirmative Votes	Affirmative Fraction	Negative Votes w/ Comment	Negative Fraction w/ Comment	Negative Votes w/o Comment	Abstain	No Vote
Segment: 1	89	1	53	0.828	11	0.172	0	6	19
Segment: 2	6	0.1	1	0.1	0	0	0	2	3
Segment: 3	73	1	44	0.88	6	0.12	0	7	16
Segment: 4	20	1	13	0.929	1	0.071	0	1	5
Segment: 5	73	1	49	0.86	8	0.14	0	3	13

Segment	Ballot Pool	Segment Weight	Affirmative Votes	Affirmative Fraction	Negative Votes w/ Comment	Negative Fraction w/ Comment	Negative Votes w/o Comment	Abstain	No Vote
Segment: 6	52	1	35	0.897	4	0.103	0	2	11
Segment: 7	1	0	0	0	0	0	0	0	1
Segment: 8	2	0.2	2	0.2	0	0	0	0	0
Segment: 9	1	0.1	1	0.1	0	0	0	0	0
Segment: 10	7	0.7	7	0.7	0	0	0	0	0
Totals:	324	6.1	205	5.494	30	0.606	0	21	68

## BALLOT POOL MEMBERS

Show  entries

Search:

Segment	Organization	Voter	Designated Proxy	Ballot	NERC Memo
1	AEP - AEP Service Corporation	Dennis Sauriol		Affirmative	N/A

Segment	Organization	Voter	Designated Proxy	Ballot	NERC Memo
1	Allete - Minnesota Power, Inc.	Jamie Monette		None	N/A
1	Ameren - Ameren Services	Eric Scott		Affirmative	N/A
1	American Transmission Company, LLC	Douglas Johnson		Affirmative	N/A
1	APS - Arizona Public Service Co.	Michelle Amaranos		Affirmative	N/A
1	Arizona Electric Power Cooperative, Inc.	John Shaver		None	N/A
1	Arkansas Electric Cooperative Corporation	Jennifer Loiacano		Affirmative	N/A
1	Associated Electric Cooperative, Inc.	Ryan Ziegler		Affirmative	N/A
1	Avista - Avista Corporation	Mike Magruder		None	N/A
1	Balancing Authority of Northern California	Kevin Smith	Joe Tarantino	Affirmative	N/A
1	Basin Electric Power Cooperative	David Rudolph		Affirmative	N/A
1	BC Hydro and Power Authority	Patricia Robertson		Abstain	N/A
1	Beaches Energy Services	Don Cuevas	Brandon McCormick	Affirmative	N/A
1	Berkshire Hathaway Energy - MidAmerican Energy Co.	Terry Harbour		None	N/A
1	Black Hills Corporation	Wes Wingen		Negative	Comments Submitted
1	Bonneville Power Administration	Kammy Rogers-Holliday		Affirmative	N/A
1	Brazos Electric Power Cooperative, Inc.	Tony Kroskey		None	N/A
1	CenterPoint Energy Houston Electric, LLC	Daniela Hammons		Affirmative	N/A



Segment	Organization	Voter	Designated Proxy	Ballot	NERC Memo
1	Central Electric Power Cooperative (Missouri)	Michael Bax		None	N/A
1	Central Hudson Gas & Electric Corp.	Frank Pace		Affirmative	N/A
1	City Utilities of Springfield, Missouri	Michael Buyce		Negative	Third-Party Comments
1	Cleco Corporation	John Lindsey	Louis Guidry	None	N/A
1	CMS Energy - Consumers Energy Company	James Anderson		Negative	Comments Submitted
1	Con Ed - Consolidated Edison Co. of New York	Dermot Smyth		Affirmative	N/A
1	Dominion - Dominion Virginia Power	Larry Nash		Affirmative	N/A
1	Duke Energy	Laura Lee		Affirmative	N/A
1	Edison International - Southern California Edison Company	Steven Mavis		Affirmative	N/A
1	Entergy - Entergy Services, Inc.	Oliver Burke		Affirmative	N/A
1	Eversource Energy	Quintin Lee		Affirmative	N/A
1	Exelon	Chris Scanlon		Affirmative	N/A
1	FirstEnergy - FirstEnergy Corporation	Julie Severino		Affirmative	N/A
1	Gainesville Regional Utilities	David Owens	Brandon McCormick	Affirmative	N/A
1	Georgia Transmission Corporation	Greg Davis		Affirmative	N/A
1	Glencoe Light and Power Commission	Terry Volkmann		Affirmative	N/A

Segment	Organization	Voter	Designated Proxy	Ballot	NERC Memo
1	Great Plains Energy - Kansas City Power and Light Co.	James McBee	Douglas Webb	Affirmative	N/A
1	Great River Energy	Gordon Pietsch		None	N/A
1	Hydro-Qu?bec TransEnergie	Nicolas Turcotte		Affirmative	N/A
1	IDACORP - Idaho Power Company	Laura Nelson		Negative	Comments Submitted
1	Imperial Irrigation District	Jesus Sammy Alcaraz		None	N/A
1	International Transmission Company Holdings Corporation	Michael Moltane	Stephanie Burns	Negative	Comments Submitted
1	JEA	Ted Hobson		Affirmative	N/A
1	Lakeland Electric	Larry Watt		Negative	Comments Submitted
1	Lincoln Electric System	Danny Pudenz		Affirmative	N/A
1	Long Island Power Authority	Robert Ganley		None	N/A
1	Los Angeles Department of Water and Power	faranak sarbaz		None	N/A
1	Lower Colorado River Authority	William Sanders		Affirmative	N/A
1	Manitoba Hydro	Mike Smith		Affirmative	N/A
1	MEAG Power	David Weekley	Scott Miller	Affirmative	N/A
1	Minnkota Power Cooperative Inc.	Theresa Allard	Andy Fuhrman	Negative	Comments Submitted
1	Muscataine Power and Water	Andy Kurriger		None	N/A

Segment	Organization	Voter	Designated Proxy	Ballot	NERC Memo
1	National Grid USA	Michael Jones		Affirmative	N/A
1	NB Power Corporation	Randy MacDonald		None	N/A
1	Nebraska Public Power District	Jamison Cawley		Affirmative	N/A
1	Network and Security Technologies	Nicholas Lauriat		Affirmative	N/A
1	New York Power Authority	Salvatore Spagnolo		Affirmative	N/A
1	NextEra Energy - Florida Power and Light Co.	Mike O'Neil		Affirmative	N/A
1	NiSource - Northern Indiana Public Service Co.	Steve Toosevich		Affirmative	N/A
1	OGE Energy - Oklahoma Gas and Electric Co.	Terri Pyle		Negative	Third-Party Comments
1	Omaha Public Power District	Doug Peterchuck		Affirmative	N/A
1	Oncor Electric Delivery	Lee Maurer	Tho Tran	Affirmative	N/A
1	OTP - Otter Tail Power Company	Charles Wicklund		Affirmative	N/A
1	Peak Reliability	Scott Downey		Affirmative	N/A
1	PNM Resources - Public Service Company of New Mexico	Laurie Williams		Abstain	N/A
1	Portland General Electric Co.	Nathaniel Clague		None	N/A
1	PPL Electric Utilities Corporation	Brenda Truhe		Affirmative	N/A
1	PSEG - Public Service Electric and Gas Co.	Joseph Smith		Affirmative	N/A
1	Public Utility District No. 1 of Chelan County	Jeff Kimbell		Abstain	N/A
1	Public Utility District No. 1 of Chelan County	Kevin Conway		None	N/A

Segment	Organization	Voter	Designated Proxy	Ballot	NERC Memo
1	Public Utility District No. 1 of Snohomish County	Long Duong		Affirmative	N/A
1	Puget Sound Energy, Inc.	Theresa Rakowsky		Affirmative	N/A
1	Sacramento Municipal Utility District	Arthur Starkovich	Joe Tarantino	Affirmative	N/A
1	Santee Cooper	Chris Wagner		Negative	Comments Submitted
1	SaskPower	Wayne Guttormson		Abstain	N/A
1	SCANA - South Carolina Electric and Gas Co.	Tom Hanzlik		Abstain	N/A
1	Seattle City Light	Pawel Krupa		None	N/A
1	Seminole Electric Cooperative, Inc.	Mark Churilla		Abstain	N/A
1	Sempra - San Diego Gas and Electric	Mo Derbas		None	N/A
1	Sho-Me Power Electric Cooperative	Peter Dawson		Affirmative	N/A
1	Southern Company - Southern Company Services, Inc.	Katherine Prewitt		Affirmative	N/A
1	Sunflower Electric Power Corporation	Paul Mehlhaff		Negative	Third-Party Comments
1	Tacoma Public Utilities (Tacoma, WA)	John Merrell		Affirmative	N/A
1	Tallahassee Electric (City of Tallahassee, FL)	Scott Langston		None	N/A
1	Tennessee Valley Authority	Gabe Kurtz		Affirmative	N/A
1	Tri-State G and T Association, Inc.	Tracy Sliman		Affirmative	N/A
1	U.S. Bureau of Reclamation	Richard Jackson		Negative	Comments Submitted

Segment	Organization	Voter	Designated Proxy	Ballot	NERC Memo
1	Unisource - Tucson Electric Power Co.	John Tolo		None	N/A
1	Westar Energy	Allen Klassen	Douglas Webb	Affirmative	N/A
1	Western Area Power Administration	sean erickson		Affirmative	N/A
1	Xcel Energy, Inc.	Dean Schiro		Affirmative	N/A
2	Electric Reliability Council of Texas, Inc.	Brandon Gleason		Abstain	N/A
2	Independent Electricity System Operator	Leonard Kula		Affirmative	N/A
2	Midcontinent ISO, Inc.	David Zwergel		None	N/A
2	New York Independent System Operator	Gregory Campoli		None	N/A
2	PJM Interconnection, L.L.C.	Mark Holman		Abstain	N/A
2	Southwest Power Pool, Inc. (RTO)	Charles Yeung		None	N/A
3	AEP	Leanna Lamatrice		Affirmative	N/A
3	Ameren - Ameren Services	David Jendras		Affirmative	N/A
3	APS - Arizona Public Service Co.	Vivian Vo		Affirmative	N/A
3	Associated Electric Cooperative, Inc.	Todd Bennett		Affirmative	N/A
3	Austin Energy	W. Dwayne Preston		None	N/A
3	Avista - Avista Corporation	Scott Kinney		Abstain	N/A
3	Basin Electric Power Cooperative	Jeremy Voll		Affirmative	N/A
3	Beaches Energy Services	Steven Lancaster	Brandon McCormick	Affirmative	N/A

Segment	Organization	Voter	Designated Proxy	Ballot	NERC Memo
3	Berkshire Hathaway Energy - MidAmerican Energy Co.	Annette Johnston		Affirmative	N/A
3	Black Hills Corporation	Eric Egge		Negative	Comments Submitted
3	Bonneville Power Administration	Rebecca Berdahl		Affirmative	N/A
3	City of Farmington	Linda Jacobson-Quinn		Abstain	N/A
3	City of Vero Beach	Ginny Beigel	Brandon McCormick	Affirmative	N/A
3	City Utilities of Springfield, Missouri	Scott Williams		Affirmative	N/A
3	Clark Public Utilities	Jack Stamper		None	N/A
3	Cleco Corporation	Maurice Paulk	Louis Guidry	None	N/A
3	CMS Energy - Consumers Energy Company	Karl Blaszkowski		Negative	Comments Submitted
3	Con Ed - Consolidated Edison Co. of New York	Peter Yost		Affirmative	N/A
3	Cowlitz County PUD	Russell Noble		Affirmative	N/A
3	Dominion - Dominion Resources, Inc.	Connie Lowe		Affirmative	N/A
3	DTE Energy - Detroit Edison Company	Karie Barczak		None	N/A
3	Duke Energy	Lee Schuster		Affirmative	N/A
3	Edison International - Southern California Edison Company	Romel Aquino		Affirmative	N/A
3	Empire District Electric Co.	Kalem Long		None	N/A

Segment	Organization	Voter	Designated Proxy	Ballot	NERC Memo
3	Eversource Energy	Sharon Flannery		Affirmative	N/A
3	Exelon	John Bee		Affirmative	N/A
3	FirstEnergy - FirstEnergy Corporation	Aaron Ghodooshim		Affirmative	N/A
3	Gainesville Regional Utilities	Ken Simmons	Brandon McCormick	Affirmative	N/A
3	Georgia System Operations Corporation	Scott McGough		None	N/A
3	Great Plains Energy - Kansas City Power and Light Co.	John Carlson	Douglas Webb	Affirmative	N/A
3	Hydro One Networks, Inc.	Paul Malozewski	Oshani Pathirane	Affirmative	N/A
3	Imperial Irrigation District	Denise Sanchez		None	N/A
3	Intermountain REA	David Maier		Affirmative	N/A
3	JEA	Garry Baker		None	N/A
3	KAMO Electric Cooperative	Tony Gott		None	N/A
3	Lakeland Electric	Patricia Boody		Negative	Comments Submitted
3	M and A Electric Power Cooperative	Stephen Pogue		Affirmative	N/A
3	Manitoba Hydro	Karim Abdel-Hadi		None	N/A
3	MEAG Power	Roger Brand	Scott Miller	Affirmative	N/A
3	Muscatine Power and Water	Seth Shoemaker		Affirmative	N/A
3	National Grid USA	Brian Shanahan		None	N/A

Segment	Organization	Voter	Designated Proxy	Ballot	NERC Memo
3	Nebraska Public Power District	Tony Eddleman		Affirmative	N/A
3	New York Power Authority	David Rivera		Affirmative	N/A
3	NiSource - Northern Indiana Public Service Co.	Dmitriy Bazylyuk		Affirmative	N/A
3	North Carolina Electric Membership Corporation	doug white	Kagen DelRio	Affirmative	N/A
3	Northeast Missouri Electric Power Cooperative	Skyler Wiegmann		None	N/A
3	Ocala Utility Services	Neville Bowen	Brandon McCormick	Affirmative	N/A
3	OGE Energy - Oklahoma Gas and Electric Co.	Donald Hargrove		Negative	Third-Party Comments
3	Omaha Public Power District	Aaron Smith		Negative	Third-Party Comments
3	OTP - Otter Tail Power Company	Wendi Olson		Affirmative	N/A
3	Owensboro Municipal Utilities	Thomas Lyons		Affirmative	N/A
3	Platte River Power Authority	Jeff Landis		Abstain	N/A
3	Portland General Electric Co.	Angela Gaines		Abstain	N/A
3	PPL - Louisville Gas and Electric Co.	Charles Freibert		Affirmative	N/A
3	Public Utility District No. 1 of Chelan County	Joyce Gundry		Abstain	N/A
3	Public Utility District No. 1 of Pend Oreille County	Amber Orr		Affirmative	N/A
3	Rutherford EMC	Tom Haire		None	N/A
3	Sacramento Municipal Utility District	Nicole Looney	Joe Tarantino	Affirmative	N/A



Segment	Organization	Voter	Designated Proxy	Ballot	NERC Memo
3	Santee Cooper	James Poston		Negative	Comments Submitted
3	SCANA - South Carolina Electric and Gas Co.	Scott Parker		Abstain	N/A
3	Seminole Electric Cooperative, Inc.	James Frauen		Abstain	N/A
3	Sempra - San Diego Gas and Electric	Bridget Silvia	Jeff Johnson	Affirmative	N/A
3	Sho-Me Power Electric Cooperative	Jeff Neas		Affirmative	N/A
3	Snohomish County PUD No. 1	Holly Chaney		Affirmative	N/A
3	Southern Company - Alabama Power Company	Joel Dembowski		Affirmative	N/A
3	Southern Indiana Gas and Electric Co.	Ryan Abshier		None	N/A
3	Tacoma Public Utilities (Tacoma, WA)	Marc Donaldson		Affirmative	N/A
3	TECO - Tampa Electric Co.	Ronald Donahey		None	N/A
3	Tennessee Valley Authority	Ian Grant		Affirmative	N/A
3	Tri-State G and T Association, Inc.	Janelle Marriott Gill		None	N/A
3	WEC Energy Group, Inc.	Thomas Breene		Affirmative	N/A
3	Westar Energy	Bryan Taggart	Douglas Webb	Affirmative	N/A
3	Xcel Energy, Inc.	Michael Ibold		Affirmative	N/A
4	Alliant Energy Corporation Services, Inc.	Larry Heckert		Affirmative	N/A
4	American Public Power Association	Jack Cashin		None	N/A
4	Arkansas Electric Cooperative Corporation	Alice Wright		Affirmative	N/A

Segment	Organization	Voter	Designated Proxy	Ballot	NERC Memo
4	Austin Energy	Esther Weekes		None	N/A
4	City of Poplar Bluff	Neal Williams		None	N/A
4	City Utilities of Springfield, Missouri	John Allen		Affirmative	N/A
4	CMS Energy - Consumers Energy Company	Theresa Martinez		Negative	Comments Submitted
4	FirstEnergy - FirstEnergy Corporation	Aubrey Short		Affirmative	N/A
4	Florida Municipal Power Agency	Carol Chinn	Brandon McCormick	Affirmative	N/A
4	Georgia System Operations Corporation	Andrea Barclay		Affirmative	N/A
4	Illinois Municipal Electric Agency	Mary Ann Todd		Abstain	N/A
4	MGE Energy - Madison Gas and Electric Co.	Joseph DePoorter		Affirmative	N/A
4	National Rural Electric Cooperative Association	Barry Lawson		Affirmative	N/A
4	North Carolina Electric Membership Corporation	John Lemire	Kagen DelRio	Affirmative	N/A
4	Public Utility District No. 1 of Snohomish County	John Martinsen		Affirmative	N/A
4	Sacramento Municipal Utility District	Beth Tincher	Joe Tarantino	Affirmative	N/A
4	Seattle City Light	Hao Li		Affirmative	N/A
4	South Mississippi Electric Power Association	Steve McElhaney		None	N/A
4	Tacoma Public Utilities (Tacoma, WA)	Hien Ho		None	N/A
4	WEC Energy Group, Inc.	Anthony Jankowski		Affirmative	N/A
4		Thomas Foltz		Affirmative	N/A

Segment	Organization	Voter	Designated Proxy	Ballot	NERC Memo
5	Ameren - Ameren Missouri	Sam Dwyer		Affirmative	N/A
5	APS - Arizona Public Service Co.	Kelsi Rigby		Affirmative	N/A
5	Arkansas Electric Cooperative Corporation	Moses Harris		Affirmative	N/A
5	Associated Electric Cooperative, Inc.	Brad Haralson		Affirmative	N/A
5	Austin Energy	Shirley Mathew		None	N/A
5	Avista - Avista Corporation	Glen Farmer		None	N/A
5	Basin Electric Power Cooperative	Mike Kraft		Affirmative	N/A
5	BC Hydro and Power Authority	Helen Hamilton Harding		Abstain	N/A
5	Berkshire Hathaway - NV Energy	Kevin Salsbury		Affirmative	N/A
5	Black Hills Corporation	George Tatar		Negative	Comments Submitted
5	Boise-Kuna Irrigation District - Lucky Peak Power Plant Project	Mike Kukla		Affirmative	N/A
5	Bonneville Power Administration	Scott Winner		Affirmative	N/A
5	Brazos Electric Power Cooperative, Inc.	Shari Heino		Negative	Third-Party Comments
5	Choctaw Generation Limited Partnership, LLLP	Rob Watson		Affirmative	N/A
5	City Water, Light and Power of Springfield, IL	Steve Rose		Affirmative	N/A
5	Cleco Corporation	Stephanie Huffman	Louis Guidry	None	N/A

Segment	Organization	Voter	Designated Proxy	Ballot	NERC Memo
5	CMS Energy - Consumers Energy Company	David Greyerbiehl		Negative	Comments Submitted
5	Con Ed - Consolidated Edison Co. of New York	William Winters	Daniel Valle	Affirmative	N/A
5	Cowlitz County PUD	Deanna Carlson		Affirmative	N/A
5	Dominion - Dominion Resources, Inc.	Lou Oberski		Affirmative	N/A
5	DTE Energy - Detroit Edison Company	Jeffrey DePriest		None	N/A
5	Duke Energy	Dale Goodwine		Affirmative	N/A
5	Entergy	Jamie Prater		Affirmative	N/A
5	Exelon	Ruth Miller		Affirmative	N/A
5	FirstEnergy - FirstEnergy Solutions	Robert Loy		Affirmative	N/A
5	Florida Municipal Power Agency	Chris Gowder	Brandon McCormick	Affirmative	N/A
5	Great Plains Energy - Kansas City Power and Light Co.	Harold Wyble	Douglas Webb	Affirmative	N/A
5	Great River Energy	Preston Walsh		Affirmative	N/A
5	Hydro-Quebec Production	Junji Yamaguchi		None	N/A
5	JEA	John Babik		Affirmative	N/A
5	Lakeland Electric	Jim Howard		Negative	Comments Submitted
5	Lincoln Electric System	Kayleigh Wilkerson		Affirmative	N/A
5	Los Angeles Department of Water and Power	Glenn Barry		None	N/A

<b>Segment</b>	<b>Organization</b>	<b>Voter</b>	<b>Designated Proxy</b>	<b>Ballot</b>	<b>NERC Memo</b>
5	Lower Colorado River Authority	Teresa Cantwell		Affirmative	N/A
5	Manitoba Hydro	Yuguang Xiao	Helen Zhao	Affirmative	N/A
5	Massachusetts Municipal Wholesale Electric Company	David Gordon		Affirmative	N/A
5	MEAG Power	Steven Grego	Scott Miller	Affirmative	N/A
5	Muscatine Power and Water	Neal Nelson		Affirmative	N/A
5	National Grid USA	Elizabeth Spivak		Affirmative	N/A
5	NaturEner USA, LLC	Eric Smith		None	N/A
5	NB Power Corporation	Laura McLeod		None	N/A
5	Nebraska Public Power District	Don Schmit		Affirmative	N/A
5	New York Power Authority	Shivaz Chopra		Affirmative	N/A
5	NiSource - Northern Indiana Public Service Co.	Kathryn Tackett		Affirmative	N/A
5	North Carolina Electric Membership Corporation	Robert Beadle	Kagen DelRio	Affirmative	N/A
5	NRG - NRG Energy, Inc.	Patricia Lynch		Affirmative	N/A
5	OGE Energy - Oklahoma Gas and Electric Co.	John Rhea		Negative	Third-Party Comments
5	Oglethorpe Power Corporation	Donna Johnson		Affirmative	N/A
5	Omaha Public Power District	Mahmood Safi		Affirmative	N/A
5	Platte River Power Authority	Tyson Archie		Negative	Comments Submitted

Segment	Organization	Voter	Designated Proxy	Ballot	NERC Memo
5	Portland General Electric Co.	Ryan Olson		None	N/A
5	PPL - Louisville Gas and Electric Co.	JULIE HOSTRANDER		Affirmative	N/A
5	PSEG - PSEG Fossil LLC	Tim Kucey		Affirmative	N/A
5	Public Utility District No. 1 of Chelan County	Meaghan Connell		Abstain	N/A
5	Public Utility District No. 1 of Snohomish County	Sam Nietfeld		Affirmative	N/A
5	Public Utility District No. 2 of Grant County, Washington	Alex Ybarra		Affirmative	N/A
5	Puget Sound Energy, Inc.	Eleanor Ewry		Affirmative	N/A
5	Sacramento Municipal Utility District	Susan Oto	Joe Tarantino	Affirmative	N/A
5	Santee Cooper	Tommy Curtis		Negative	Comments Submitted
5	SCANA - South Carolina Electric and Gas Co.	Alyssa Hubbard		Abstain	N/A
5	Seattle City Light	Faz Kasraie		None	N/A
5	Sempra - San Diego Gas and Electric	Daniel Frank	Andrey Komissarov	Affirmative	N/A
5	Southern Company - Southern Company Generation	William D. Shultz		Affirmative	N/A
5	SunPower	Bradley Collard		None	N/A
5	Tacoma Public Utilities (Tacoma, WA)	Ozan Ferrin		Affirmative	N/A
5	Tennessee Valley Authority	M Lee Thomas		Affirmative	N/A
5	Tri State Generation Association, Inc.	Richard Schlottmann		None	N/A

Segment	Organization	Voter	Designated Proxy	Ballot	NERC Memo
5	U.S. Bureau of Reclamation	Wendy Center		Negative	Comments Submitted
5	Vistra Energy	Dan Roethemeyer		None	N/A
5	WEC Energy Group, Inc.	Linda Horn		Affirmative	N/A
5	Westar Energy	Derek Brown	Douglas Webb	Affirmative	N/A
5	Xcel Energy, Inc.	Gerry Huitt		Affirmative	N/A
6	AEP - AEP Marketing	Yee Chou		Affirmative	N/A
6	Ameren - Ameren Services	Robert Quinlivan		Affirmative	N/A
6	APS - Arizona Public Service Co.	Nicholas Kirby		Affirmative	N/A
6	Arkansas Electric Cooperative Corporation	Bruce Walkup		Affirmative	N/A
6	Associated Electric Cooperative, Inc.	Brian Ackermann		Affirmative	N/A
6	Austin Energy	Andrew Gallo		None	N/A
6	Basin Electric Power Cooperative	Jerry Horner		None	N/A
6	Berkshire Hathaway - PacifiCorp	Sandra Shaffer		Affirmative	N/A
6	Black Hills Corporation	Eric Scherr		Negative	Comments Submitted
6	Bonneville Power Administration	Andrew Meyers		Affirmative	N/A
6	Cleco Corporation	Robert Hirschak	Louis Guidry	None	N/A
6	Con Ed - Consolidated Edison Co. of New York	Christopher Overberg		Affirmative	N/A

Segment	Organization	Voter	Designated Proxy	Ballot	NERC Memo
6	Dominion - Dominion Resources, Inc.	Sean Bodkin		Affirmative	N/A
6	Duke Energy	Greg Cecil		Affirmative	N/A
6	Edison International - Southern California Edison Company	Kenya Streeter		None	N/A
6	Entergy	Julie Hall		Affirmative	N/A
6	Exelon	Becky Webb		Affirmative	N/A
6	FirstEnergy - FirstEnergy Solutions	Ann Carey		Affirmative	N/A
6	Florida Municipal Power Agency	Richard Montgomery	Brandon McCormick	Affirmative	N/A
6	Florida Municipal Power Pool	Tom Reedy	Brandon McCormick	Affirmative	N/A
6	Great Plains Energy - Kansas City Power and Light Co.	Jennifer Flandermeyer	Douglas Webb	Affirmative	N/A
6	Great River Energy	Donna Stephenson	Michael Brytowski	Affirmative	N/A
6	Lincoln Electric System	Eric Ruskamp		Affirmative	N/A
6	Los Angeles Department of Water and Power	Anton Vu		Affirmative	N/A
6	Luminant - Luminant Energy	Kris Butler		None	N/A
6	Manitoba Hydro	Blair Mukanik		None	N/A
6	Muscatine Power and Water	Ryan Streck		Affirmative	N/A
6	New York Power Authority	Thomas Savin		Affirmative	N/A
6	NextEra Energy - Florida Power and Light Co.	Silvia Mitchell		Affirmative	N/A



Segment	Organization	Voter	Designated Proxy	Ballot	NERC Memo
6	NiSource - Northern Indiana Public Service Co.	Joe O'Brien		Affirmative	N/A
6	Northern California Power Agency	Dennis Sismaet		Negative	Comments Submitted
6	NRG - NRG Energy, Inc.	Martin Sidor		Affirmative	N/A
6	OGE Energy - Oklahoma Gas and Electric Co.	Sing Tay		Negative	Third-Party Comments
6	Platte River Power Authority	Sabrina Martz		None	N/A
6	Portland General Electric Co.	Daniel Mason		None	N/A
6	PPL - Louisville Gas and Electric Co.	Linn Oelker		Affirmative	N/A
6	PSEG - PSEG Energy Resources and Trade LLC	Karla Barton		Affirmative	N/A
6	Public Utility District No. 1 of Chelan County	Davis Jelusich		Abstain	N/A
6	Public Utility District No. 2 of Grant County, Washington	LeRoy Patterson		None	N/A
6	Sacramento Municipal Utility District	Jamie Cutlip	Joe Tarantino	Affirmative	N/A
6	Santee Cooper	Michael Brown		Negative	Comments Submitted
6	SCANA - South Carolina Electric and Gas Co.	John Folsom		None	N/A
6	Seattle City Light	Charles Freeman		Affirmative	N/A
6	Seminole Electric Cooperative, Inc.	Trudy Novak		Abstain	N/A
6	Snohomish County PUD No. 1	Franklin Lu		Affirmative	N/A

Segment	Organization	Voter	Designated Proxy	Ballot	NERC Memo
6	Southern Company - Southern Company Generation and Energy Marketing	Jennifer Sykes		Affirmative	N/A
6	Southern Indiana Gas and Electric Co.	Brad Lisembee		None	N/A
6	Tacoma Public Utilities (Tacoma, WA)	Rick Applegate		Affirmative	N/A
6	Tennessee Valley Authority	Marjorie Parsons		Affirmative	N/A
6	WEC Energy Group, Inc.	David Hathaway		Affirmative	N/A
6	Westar Energy	Grant Wilkerson	Douglas Webb	Affirmative	N/A
6	Xcel Energy, Inc.	Carrie Dixon		Affirmative	N/A
7	Luminant Mining Company LLC	Amanda Frazier		None	N/A
8	David Kiguel	David Kiguel		Affirmative	N/A
8	Roger Zaklukiewicz	Roger Zaklukiewicz		Affirmative	N/A
9	Commonwealth of Massachusetts Department of Public Utilities	Donald Nelson		Affirmative	N/A
10	Florida Reliability Coordinating Council	Peter Heidrich		Affirmative	N/A
10	Midwest Reliability Organization	Russel Mountjoy		Affirmative	N/A
10	New York State Reliability Council	ALAN ADAMSON		Affirmative	N/A
10	Northeast Power Coordinating Council	Guy V. Zito		Affirmative	N/A
10	ReliabilityFirst	Anthony Jablonski		Affirmative	N/A
10	SERC Reliability Corporation	Drew Slabaugh		Affirmative	N/A
10	Texas Reliability Entity, ERCOT	Rachel Coyne		Affirmative	N/A

Showing 1 to 324 of 324 entries

Previous

1

Next

# BALLOT RESULTS

**Ballot Name:** 2016-02 Modifications to CIP Standards CIP-003-8 NBP IN 1 NB

**Voting Start Date:** 9/28/2018 12:01:00 AM

**Voting End Date:** 10/9/2018 8:00:00 PM

**Ballot Type:** NB

**Ballot Activity:** IN

**Ballot Series:** 1

**Total # Votes:** 232

**Total Ballot Pool:** 307

**Quorum:** 75.57

**Weighted Segment Value:** 89.2

Segment	Ballot Pool	Segment Weight	Affirmative Votes	Affirmative Fraction	Negative Votes	Negative Fraction	Abstain	No Vote
Segment: 1	85	1	39	0.886	5	0.114	18	23
Segment: 2	6	0.1	1	0.1	0	0	2	3
Segment: 3	70	1	36	0.878	5	0.122	14	15
Segment: 4	19	1	9	0.9	1	0.1	3	6
Segment: 5	68	1	35	0.854	6	0.146	10	17
Segment: 6	48	1	27	0.931	2	0.069	9	10
Segment: 7	1	0	0	0	0	0	0	1
Segment: 8	2	0.2	2	0.2	0	0	0	0
Segment: 9	1	0.1	1	0.1	0	0	0	0

Segment	Ballot Pool	Segment Weight	Affirmative Votes	Affirmative Fraction	Negative Votes	Negative Fraction	Abstain	No Vote
Segment: 10	7	0.7	7	0.7	0	0	0	0
Totals:	307	6.1	157	5.549	19	0.551	56	75

## BALLOT POOL MEMBERS

Show  entries

Search:

Segment	Organization	Voter	Designated Proxy	Ballot	NERC Memo
1	AEP - AEP Service Corporation	Dennis Sauriol		Abstain	N/A
1	Ameren - Ameren Services	Eric Scott		Abstain	N/A
1	American Transmission Company, LLC	Douglas Johnson		Affirmative	N/A
1	APS - Arizona Public Service Co.	Michelle Amarantos		Affirmative	N/A
1	Arizona Electric Power Cooperative, Inc.	John Shaver		None	N/A
1	Arkansas Electric Cooperative Corporation	Jennifer Loiacano		None	N/A
1	Associated Electric Cooperative, Inc.	Ryan Ziegler		Affirmative	N/A

Segment	Organization	Voter	Designated Proxy	Ballot	NERC Memo
1	Avista - Avista Corporation	Mike Magruder		None	N/A
1	Balancing Authority of Northern California	Kevin Smith	Joe Tarantino	Affirmative	N/A
1	Basin Electric Power Cooperative	David Rudolph		Affirmative	N/A
1	BC Hydro and Power Authority	Patricia Robertson		Abstain	N/A
1	Beaches Energy Services	Don Cuevas	Brandon McCormick	Affirmative	N/A
1	Berkshire Hathaway Energy - MidAmerican Energy Co.	Terry Harbour		None	N/A
1	Black Hills Corporation	Wes Wingen		None	N/A
1	Bonneville Power Administration	Kammy Rogers-Holliday		Affirmative	N/A
1	Brazos Electric Power Cooperative, Inc.	Tony Kroskey		None	N/A
1	CenterPoint Energy Houston Electric, LLC	Daniela Hammons		Abstain	N/A
1	Central Electric Power Cooperative (Missouri)	Michael Bax		None	N/A
1	Central Hudson Gas & Electric Corp.	Frank Pace		Affirmative	N/A
1	City Utilities of Springfield, Missouri	Michael Buyce		Affirmative	N/A
1	Cleco Corporation	John Lindsey	Louis Guidry	None	N/A
1	CMS Energy - Consumers Energy Company	James Anderson		Negative	Comments Submitted
1	Con Ed - Consolidated Edison Co. of New York	Dermot Smyth		Affirmative	N/A
1	Domino - Dominion Virginia Power	Larry Nash		Abstain	N/A

Segment	Organization	Voter	Designated Proxy	Ballot	NERC Memo
1	Duke Energy	Laura Lee		Affirmative	N/A
1	Edison International - Southern California Edison Company	Steven Mavis		Affirmative	N/A
1	Entergy - Entergy Services, Inc.	Oliver Burke		Affirmative	N/A
1	Eversource Energy	Quintin Lee		Abstain	N/A
1	Exelon	Chris Scanlon		Affirmative	N/A
1	FirstEnergy - FirstEnergy Corporation	Julie Severino		Affirmative	N/A
1	Gainesville Regional Utilities	David Owens	Brandon McCormick	Affirmative	N/A
1	Georgia Transmission Corporation	Greg Davis		Affirmative	N/A
1	Glencoe Light and Power Commission	Terry Volkmann		Affirmative	N/A
1	Great Plains Energy - Kansas City Power and Light Co.	James McBee	Douglas Webb	Affirmative	N/A
1	Great River Energy	Gordon Pietsch		None	N/A
1	Hydro-Qu?bec TransEnergie	Nicolas Turcotte		Affirmative	N/A
1	IDACORP - Idaho Power Company	Laura Nelson		Negative	Comments Submitted
1	Imperial Irrigation District	Jesus Sammy Alcaraz		None	N/A
1	International Transmission Company Holdings Corporation	Michael Moltane	Allie Gavin	None	N/A

Segment	Organization	Voter	Designated Proxy	Ballot	NERC Memo
1	Lakeland Electric	Larry Watt		Negative	Comments Submitted
1	Lincoln Electric System	Danny Pudenz		Abstain	N/A
1	Long Island Power Authority	Robert Ganley		None	N/A
1	Los Angeles Department of Water and Power	faranak sarbaz		None	N/A
1	Lower Colorado River Authority	William Sanders		Affirmative	N/A
1	Manitoba Hydro	Mike Smith		Affirmative	N/A
1	MEAG Power	David Weekley	Scott Miller	Affirmative	N/A
1	Minnkota Power Cooperative Inc.	Theresa Allard	Andy Fuhrman	None	N/A
1	Muscatine Power and Water	Andy Kurriger		None	N/A
1	National Grid USA	Michael Jones		Affirmative	N/A
1	NB Power Corporation	Randy MacDonald		Affirmative	N/A
1	Nebraska Public Power District	Jamison Cawley		Abstain	N/A
1	Network and Security Technologies	Nicholas Lauriat		Affirmative	N/A
1	New York Power Authority	Salvatore Spagnolo		Affirmative	N/A
1	NextEra Energy - Florida Power and Light Co.	Mike O'Neil		Affirmative	N/A
1	NiSource - Northern Indiana Public Service Co.	Steve Toosevich		Affirmative	N/A
1	OGE Energy - Oklahoma Gas and Electric Co.	Terri Pyle		Negative	Comments Submitted
1	Omaha Public Power District	Doug Peterchuck		Affirmative	N/A



<b>Segment</b>	<b>Organization</b>	<b>Voter</b>	<b>Designated Proxy</b>	<b>Ballot</b>	<b>NERC Memo</b>
1	OTP - Otter Tail Power Company	Charles Wicklund		None	N/A
1	Peak Reliability	Scott Downey		None	N/A
1	PNM Resources - Public Service Company of New Mexico	Laurie Williams		Abstain	N/A
1	Portland General Electric Co.	Nathaniel Clague		None	N/A
1	PPL Electric Utilities Corporation	Brenda Truhe		Abstain	N/A
1	PSEG - Public Service Electric and Gas Co.	Joseph Smith		Abstain	N/A
1	Public Utility District No. 1 of Chelan County	Jeff Kimbell		Abstain	N/A
1	Public Utility District No. 1 of Pend Oreille County	Kevin Conway		None	N/A
1	Public Utility District No. 1 of Snohomish County	Long Duong		Affirmative	N/A
1	Puget Sound Energy, Inc.	Theresa Rakowsky		Affirmative	N/A
1	Sacramento Municipal Utility District	Arthur Starkovich	Joe Tarantino	Affirmative	N/A
1	Santee Cooper	Chris Wagner		Abstain	N/A
1	SaskPower	Wayne Guttormson		Affirmative	N/A
1	SCANA - South Carolina Electric and Gas Co.	Tom Hanzlik		Abstain	N/A
1	Seattle City Light	Pawel Krupa		None	N/A
1	Seminole Electric Cooperative, Inc.	Mark Churilla		Abstain	N/A
1	Sempra - San Diego Gas and Electric	Mo Derbas		None	N/A
1	Sho-Me Power Electric Cooperative	Peter Dawson		Affirmative	N/A

Segment	Organization	Voter	Designated Proxy	Ballot	NERC Memo
1	Southern Company - Southern Company Services, Inc.	Katherine Prewitt		Affirmative	N/A
1	Sunflower Electric Power Corporation	Paul Mehlhaff		Abstain	N/A
1	Tacoma Public Utilities (Tacoma, WA)	John Merrell		Affirmative	N/A
1	Tallahassee Electric (City of Tallahassee, FL)	Scott Langston		None	N/A
1	Tennessee Valley Authority	Gabe Kurtz		Abstain	N/A
1	Tri-State G and T Association, Inc.	Tracy Sliman		Affirmative	N/A
1	U.S. Bureau of Reclamation	Richard Jackson		Negative	Comments Submitted
1	Unisource - Tucson Electric Power Co.	John Tolo		None	N/A
1	Westar Energy	Allen Klassen	Douglas Webb	Affirmative	N/A
1	Western Area Power Administration	sean erickson		Abstain	N/A
2	Electric Reliability Council of Texas, Inc.	Brandon Gleason		Abstain	N/A
2	Independent Electricity System Operator	Leonard Kula		Affirmative	N/A
2	Midcontinent ISO, Inc.	David Zwergel		None	N/A
2	New York Independent System Operator	Gregory Campoli		None	N/A
2	PJM Interconnection, L.L.C.	Mark Holman		Abstain	N/A
2	Southwest Power Pool, Inc. (RTO)	Charles Yeung		None	N/A
3	AEP	Leanna Lamatrice		Abstain	N/A
4	American Electric Power	David Jendras		Abstain	N/A

Segment	Organization	Voter	Designated Proxy	Ballot	NERC Memo
3	APS - Arizona Public Service Co.	Vivian Vo		Affirmative	N/A
3	Associated Electric Cooperative, Inc.	Todd Bennett		Affirmative	N/A
3	Austin Energy	W. Dwayne Preston		None	N/A
3	Avista - Avista Corporation	Scott Kinney		Abstain	N/A
3	Basin Electric Power Cooperative	Jeremy Voll		Affirmative	N/A
3	Beaches Energy Services	Steven Lancaster	Brandon McCormick	Affirmative	N/A
3	Berkshire Hathaway Energy - MidAmerican Energy Co.	Annette Johnston		Affirmative	N/A
3	Black Hills Corporation	Eric Egge		Negative	Comments Submitted
3	Bonneville Power Administration	Rebecca Berdahl		Affirmative	N/A
3	City of Farmington	Linda Jacobson-Quinn		Abstain	N/A
3	City of Vero Beach	Ginny Beigel	Brandon McCormick	Affirmative	N/A
3	City Utilities of Springfield, Missouri	Scott Williams		Affirmative	N/A
3	Clark Public Utilities	Jack Stamper		None	N/A
3	Cleco Corporation	Maurice Paulk	Louis Guidry	None	N/A
3	CMS Energy - Consumers Energy Company	Karl Blaszkowski		Negative	Comments Submitted
3	Con Ed - Consolidated Edison Co. of New York	Peter Yost		Affirmative	N/A

Segment	Organization	Voter	Designated Proxy	Ballot	NERC Memo
3	Cowlitz County PUD	Russell Noble		Affirmative	N/A
3	Dominion - Dominion Resources, Inc.	Connie Lowe		Abstain	N/A
3	DTE Energy - Detroit Edison Company	Karie Barczak		None	N/A
3	Edison International - Southern California Edison Company	Romel Aquino		Affirmative	N/A
3	Eversource Energy	Sharon Flannery		Abstain	N/A
3	Exelon	John Bee		Affirmative	N/A
3	FirstEnergy - FirstEnergy Corporation	Aaron Ghodooshim		Affirmative	N/A
3	Gainesville Regional Utilities	Ken Simmons	Brandon McCormick	Affirmative	N/A
3	Georgia System Operations Corporation	Scott McGough		None	N/A
3	Great Plains Energy - Kansas City Power and Light Co.	John Carlson	Douglas Webb	Affirmative	N/A
3	Hydro One Networks, Inc.	Paul Malozewski	Oshani Pathirane	Affirmative	N/A
3	Imperial Irrigation District	Denise Sanchez		None	N/A
3	JEA	Garry Baker		None	N/A
3	KAMO Electric Cooperative	Tony Gott		None	N/A
3	Lakeland Electric	Patricia Boody		Negative	Comments Submitted
3	M and A Electric Power Cooperative	Stephen Pogue		Affirmative	N/A
3	Manitoba Hydro	Karim Abdel-Hadi		None	N/A

Segment	Organization	Voter	Designated Proxy	Ballot	NERC Memo
3	MEAG Power	Roger Brand	Scott Miller	Affirmative	N/A
3	Muscatine Power and Water	Seth Shoemaker		Affirmative	N/A
3	National Grid USA	Brian Shanahan		None	N/A
3	Nebraska Public Power District	Tony Eddleman		Abstain	N/A
3	New York Power Authority	David Rivera		Affirmative	N/A
3	NiSource - Northern Indiana Public Service Co.	Dmitriy Bazylyuk		Affirmative	N/A
3	North Carolina Electric Membership Corporation	doug white	Kagen DelRio	Affirmative	N/A
3	Northeast Missouri Electric Power Cooperative	Skyler Wiegmann		None	N/A
3	Ocala Utility Services	Neville Bowen	Brandon McCormick	Affirmative	N/A
3	OGE Energy - Oklahoma Gas and Electric Co.	Donald Hargrove		Negative	Comments Submitted
3	Omaha Public Power District	Aaron Smith		Negative	Comments Submitted
3	OTP - Otter Tail Power Company	Wendi Olson		Affirmative	N/A
3	Owensboro Municipal Utilities	Thomas Lyons		Affirmative	N/A
3	Platte River Power Authority	Jeff Landis		Abstain	N/A
3	Portland General Electric Co.	Angela Gaines		Abstain	N/A
3	PPL - Louisville Gas and Electric Co.	Joseph Bencomo		None	N/A
3	Public Utility District No. 1 of Chelan County	Joyce Gundry		Abstain	N/A

Segment	Organization	Voter	Designated Proxy	Ballot	NERC Memo
3	Public Utility District No. 1 of Pend Oreille County	Amber Orr		Affirmative	N/A
3	Rutherford EMC	Tom Haire		None	N/A
3	Sacramento Municipal Utility District	Nicole Looney	Joe Tarantino	Affirmative	N/A
3	Santee Cooper	James Poston		Abstain	N/A
3	SCANA - South Carolina Electric and Gas Co.	Scott Parker		Abstain	N/A
3	Seattle City Light	Tuan Tran		Affirmative	N/A
3	Seminole Electric Cooperative, Inc.	James Frauen		Abstain	N/A
3	Sempra - San Diego Gas and Electric	Bridget Silvia	Jeff Johnson	Affirmative	N/A
3	Sho-Me Power Electric Cooperative	Jeff Neas		Affirmative	N/A
3	Snohomish County PUD No. 1	Holly Chaney		Affirmative	N/A
3	Southern Company - Alabama Power Company	Joel Dembowski		Affirmative	N/A
3	Tacoma Public Utilities (Tacoma, WA)	Marc Donaldson		Affirmative	N/A
3	TECO - Tampa Electric Co.	Ronald Donahey		None	N/A
3	Tennessee Valley Authority	Ian Grant		Abstain	N/A
3	Tri-State G and T Association, Inc.	Janelle Marriott Gill		None	N/A
3	WEC Energy Group, Inc.	Thomas Breene		Affirmative	N/A
3	Westar Energy	Bryan Taggart	Douglas Webb	Affirmative	N/A
3	Xcel Energy, Inc.	Michael Ibold		Affirmative	N/A
4	Alliant Energy Corporation Services, Inc.	Larry Heckert		Abstain	N/A

Segment	Organization	Voter	Designated Proxy	Ballot	NERC Memo
4	American Public Power Association	Jack Cashin		None	N/A
4	Arkansas Electric Cooperative Corporation	Alice Wright		None	N/A
4	Austin Energy	Esther Weekes		None	N/A
4	City of Poplar Bluff	Neal Williams		None	N/A
4	City Utilities of Springfield, Missouri	John Allen		Affirmative	N/A
4	CMS Energy - Consumers Energy Company	Theresa Martinez		Negative	Comments Submitted
4	FirstEnergy - FirstEnergy Corporation	Aubrey Short		Affirmative	N/A
4	Florida Municipal Power Agency	Carol Chinn	Brandon McCormick	Affirmative	N/A
4	Georgia System Operations Corporation	Andrea Barclay		Affirmative	N/A
4	Illinois Municipal Electric Agency	Mary Ann Todd		Abstain	N/A
4	MGE Energy - Madison Gas and Electric Co.	Joseph DePoorter		Abstain	N/A
4	North Carolina Electric Membership Corporation	John Lemire	Kagen DelRio	Affirmative	N/A
4	Public Utility District No. 1 of Snohomish County	John Martinsen		Affirmative	N/A
4	Sacramento Municipal Utility District	Beth Tincher	Joe Tarantino	Affirmative	N/A
4	Seattle City Light	Hao Li		Affirmative	N/A
4	South Mississippi Electric Power Association	Steve McElhaney		None	N/A
4	Tacoma Public Utilities (Tacoma, WA)	Hien Ho		None	N/A
4	WEC Energy Group	Anthony Jankowski		Affirmative	N/A

Segment	Organization	Voter	Designated Proxy	Ballot	NERC Memo
5	AEP	Thomas Foltz		Abstain	N/A
5	Ameren - Ameren Missouri	Sam Dwyer		Abstain	N/A
5	APS - Arizona Public Service Co.	Kelsi Rigby		Affirmative	N/A
5	Arkansas Electric Cooperative Corporation	Moses Harris		None	N/A
5	Associated Electric Cooperative, Inc.	Brad Haralson		Affirmative	N/A
5	Austin Energy	Shirley Mathew		None	N/A
5	Avista - Avista Corporation	Glen Farmer		Affirmative	N/A
5	Basin Electric Power Cooperative	Mike Kraft		Affirmative	N/A
5	BC Hydro and Power Authority	Helen Hamilton Harding		Abstain	N/A
5	Berkshire Hathaway - NV Energy	Kevin Salsbury		Affirmative	N/A
5	Black Hills Corporation	George Tatar		Negative	Comments Submitted
5	Boise-Kuna Irrigation District - Lucky Peak Power Plant Project	Mike Kukla		Affirmative	N/A
5	Bonneville Power Administration	Scott Winner		Affirmative	N/A
5	Brazos Electric Power Cooperative, Inc.	Shari Heino		Negative	Comments Submitted
5	Choctaw Generation Limited Partnership, LLLP	Rob Watson		Affirmative	N/A
5	City Water, Light and Power of Springfield, IL	Steve Rose		Affirmative	N/A
5	City of Chicago	Stephanie Huffman	Louis Guidry	None	N/A



Segment	Organization	Voter	Designated Proxy	Ballot	NERC Memo
5	CMS Energy - Consumers Energy Company	David Greyerbiehl		Negative	Comments Submitted
5	Con Ed - Consolidated Edison Co. of New York	William Winters	Daniel Valle	None	N/A
5	Cowlitz County PUD	Deanna Carlson		Affirmative	N/A
5	Dominion - Dominion Resources, Inc.	Lou Oberski		Affirmative	N/A
5	DTE Energy - Detroit Edison Company	Jeffrey DePriest		None	N/A
5	Duke Energy	Dale Goodwine		Affirmative	N/A
5	Entergy	Jamie Prater		Affirmative	N/A
5	Exelon	Ruth Miller		Affirmative	N/A
5	FirstEnergy - FirstEnergy Solutions	Robert Loy		Affirmative	N/A
5	Florida Municipal Power Agency	Chris Gowder	Brandon McCormick	Affirmative	N/A
5	Great Plains Energy - Kansas City Power and Light Co.	Harold Wyble	Douglas Webb	Affirmative	N/A
5	Great River Energy	Preston Walsh		Affirmative	N/A
5	Hydro-Quebec Production	Junji Yamaguchi		None	N/A
5	JEA	John Babik		None	N/A
5	Lakeland Electric	Jim Howard		Negative	Comments Submitted
5	Lincoln Electric System	Kayleigh Wilkerson		Abstain	N/A
5	Lower Colorado River Authority	Teresa Cantwell		Affirmative	N/A

Segment	Organization	Voter	Designated Proxy	Ballot	NERC Memo
5	Manitoba Hydro	Yuguang Xiao	Helen Zhao	Affirmative	N/A
5	Massachusetts Municipal Wholesale Electric Company	David Gordon		Abstain	N/A
5	MEAG Power	Steven Grego	Scott Miller	Affirmative	N/A
5	Muscatine Power and Water	Neal Nelson		None	N/A
5	NaturEner USA, LLC	Eric Smith		None	N/A
5	NB Power Corporation	Laura McLeod		None	N/A
5	Nebraska Public Power District	Don Schmit		Abstain	N/A
5	New York Power Authority	Shivaz Chopra		Affirmative	N/A
5	NiSource - Northern Indiana Public Service Co.	Kathryn Tackett		Affirmative	N/A
5	North Carolina Electric Membership Corporation	Robert Beadle	Kagen DelRio	Affirmative	N/A
5	NRG - NRG Energy, Inc.	Patricia Lynch		Affirmative	N/A
5	OGE Energy - Oklahoma Gas and Electric Co.	John Rhea		Negative	Comments Submitted
5	Oglethorpe Power Corporation	Donna Johnson		Affirmative	N/A
5	Omaha Public Power District	Mahmood Safi		Affirmative	N/A
5	Portland General Electric Co.	Ryan Olson		None	N/A
5	PPL - Louisville Gas and Electric Co.	JULIE HOSTRANDER		None	N/A
5	PSEG - PSEG Fossil LLC	Tim Kucey		Abstain	N/A

Segment	Organization	Voter	Designated Proxy	Ballot	NERC Memo
5	Public Utility District No. 1 of Chelan County	Meaghan Connell		Abstain	N/A
5	Public Utility District No. 1 of Snohomish County	Sam Nietfeld		Affirmative	N/A
5	Public Utility District No. 2 of Grant County, Washington	Alex Ybarra		Affirmative	N/A
5	Puget Sound Energy, Inc.	Eleanor Ewry		Affirmative	N/A
5	Sacramento Municipal Utility District	Susan Oto	Joe Tarantino	Affirmative	N/A
5	Santee Cooper	Tommy Curtis		Abstain	N/A
5	SCANA - South Carolina Electric and Gas Co.	Alyssa Hubbard		Abstain	N/A
5	Seattle City Light	Faz Kasraie		None	N/A
5	Sempra - San Diego Gas and Electric	Daniel Frank	Andrey Komissarov	Affirmative	N/A
5	Southern Company - Southern Company Generation	William D. Shultz		Affirmative	N/A
5	SunPower	Bradley Collard		None	N/A
5	Tacoma Public Utilities (Tacoma, WA)	Ozan Ferrin		Affirmative	N/A
5	Tennessee Valley Authority	M Lee Thomas		None	N/A
5	Tri-State G and T Association, Inc.	Richard Schlottmann		None	N/A
5	U.S. Bureau of Reclamation	Wendy Center		Negative	Comments Submitted
5	Vistra Energy	Dan Roethemeyer		None	N/A
5	Westar Energy	Derek Brown	Douglas Webb	Affirmative	N/A

Segment	Organization	Voter	Designated Proxy	Ballot	NERC Memo
6	AEP - AEP Marketing	Yee Chou		Abstain	N/A
6	Ameren - Ameren Services	Robert Quinlivan		Abstain	N/A
6	APS - Arizona Public Service Co.	Nicholas Kirby		Affirmative	N/A
6	Arkansas Electric Cooperative Corporation	Bruce Walkup		Affirmative	N/A
6	Associated Electric Cooperative, Inc.	Brian Ackermann		Affirmative	N/A
6	Austin Energy	Andrew Gallo		None	N/A
6	Basin Electric Power Cooperative	Jerry Horner		None	N/A
6	Berkshire Hathaway - PacifiCorp	Sandra Shaffer		Affirmative	N/A
6	Black Hills Corporation	Eric Scherr		Negative	Comments Submitted
6	Cleco Corporation	Robert Hirschak	Louis Guidry	None	N/A
6	Con Ed - Consolidated Edison Co. of New York	Christopher Overberg		Affirmative	N/A
6	Dominion - Dominion Resources, Inc.	Sean Bodkin		Affirmative	N/A
6	Duke Energy	Greg Cecil		Affirmative	N/A
6	Edison International - Southern California Edison Company	Kenya Streeter		None	N/A
6	Entergy	Julie Hall		Affirmative	N/A
6	Exelon	Becky Webb		Affirmative	N/A
6	FirstEnergy - FirstEnergy Solutions	Ann Carey		Affirmative	N/A

Segment	Organization	Voter	Designated Proxy	Ballot	NERC Memo
6	Florida Municipal Power Agency	Richard Montgomery	Brandon McCormick	Affirmative	N/A
6	Florida Municipal Power Pool	Tom Reedy	Brandon McCormick	Affirmative	N/A
6	Great Plains Energy - Kansas City Power and Light Co.	Jennifer Flandermeyer	Douglas Webb	Affirmative	N/A
6	Great River Energy	Donna Stephenson	Michael Brytowski	Affirmative	N/A
6	Lincoln Electric System	Eric Ruskamp		Abstain	N/A
6	Los Angeles Department of Water and Power	Anton Vu		Affirmative	N/A
6	Luminant - Luminant Energy	Kris Butler		None	N/A
6	Manitoba Hydro	Blair Mukanik		None	N/A
6	Muscatine Power and Water	Ryan Streck		Affirmative	N/A
6	New York Power Authority	Thomas Savin		Affirmative	N/A
6	NextEra Energy - Florida Power and Light Co.	Silvia Mitchell		Abstain	N/A
6	NiSource - Northern Indiana Public Service Co.	Joe O'Brien		Affirmative	N/A
6	Northern California Power Agency	Dennis Sismaet		Negative	Comments Submitted
6	NRG - NRG Energy, Inc.	Martin Sidor		Affirmative	N/A
6	Portland General Electric Co.	Daniel Mason		None	N/A
6	PPL - Louisville Gas and Electric Co.	Linn Oelker		None	N/A
6	PSEG - PSEG Energy Resources and Trade LLC	Karla Barton		Abstain	N/A

<b>Segment</b>	<b>Organization</b>	<b>Voter</b>	<b>Designated Proxy</b>	<b>Ballot</b>	<b>NERC Memo</b>
6	Public Utility District No. 1 of Chelan County	Davis Jelusich		Abstain	N/A
6	Public Utility District No. 2 of Grant County, Washington	LeRoy Patterson		None	N/A
6	Sacramento Municipal Utility District	Jamie Cutlip	Joe Tarantino	Affirmative	N/A
6	Santee Cooper	Michael Brown		Abstain	N/A
6	SCANA - South Carolina Electric and Gas Co.	John Folsom		None	N/A
6	Seattle City Light	Charles Freeman		Affirmative	N/A
6	Seminole Electric Cooperative, Inc.	Trudy Novak		Abstain	N/A
6	Snohomish County PUD No. 1	Franklin Lu		Affirmative	N/A
6	Southern Company - Southern Company Generation and Energy Marketing	Jennifer Sykes		Affirmative	N/A
6	Tacoma Public Utilities (Tacoma, WA)	Rick Applegate		Affirmative	N/A
6	Tennessee Valley Authority	Marjorie Parsons		Abstain	N/A
6	WEC Energy Group, Inc.	David Hathaway		Affirmative	N/A
6	Westar Energy	Grant Wilkerson	Douglas Webb	Affirmative	N/A
6	Xcel Energy, Inc.	Carrie Dixon		Affirmative	N/A
7	Luminant Mining Company LLC	Amanda Frazier		None	N/A
8	David Kiguel	David Kiguel		Affirmative	N/A
8	Roger Zaklukiewicz	Roger Zaklukiewicz		Affirmative	N/A

Segment	Organization	Voter	Designated Proxy	Ballot	NERC Memo
9	Commonwealth of Massachusetts Department of Public Utilities	Donald Nelson		Affirmative	N/A
10	Florida Reliability Coordinating Council	Peter Heidrich		Affirmative	N/A
10	Midwest Reliability Organization	Russel Mountjoy		Affirmative	N/A
10	New York State Reliability Council	ALAN ADAMSON		Affirmative	N/A
10	Northeast Power Coordinating Council	Guy V. Zito		Affirmative	N/A
10	ReliabilityFirst	Anthony Jablonski		Affirmative	N/A
10	SERC Reliability Corporation	Drew Slabaugh		Affirmative	N/A
10	Texas Reliability Entity, Inc.	Rachel Coyne		Affirmative	N/A

Previous 1 Next

Showing 1 to 307 of 307 entries

# Standards Announcement

## Project 2016-02 Modifications to CIP Standards

Formal Comment Period Open through **October 9, 2018**

Ballot Pools Forming through **September 21, 2018**

### [Now Available](#)

A 45-day formal comment period for **C CIP-002-6 - Cyber Security – BES Cyber System Categorization** and **CIP-003-8 - Cyber Security – Security Management Controls** is open through **8 p.m. Eastern, Tuesday, October 9, 2018**.

### Commenting

Use the [Standards Balloting and Commenting System \(SBS\)](#) to submit comments. If you experience difficulty using the SBS, contact [Wendy Muller](#). An unofficial Word version of the comment form is posted on the [project page](#).

### Ballot Pools

Ballot pools are being formed through **8 p.m. Eastern, Friday, September 21, 2018**. Registered Ballot Body members can join the ballot pools [here](#).

- *If you are having difficulty accessing the SBS due to a forgotten password, incorrect credential error messages, or system lock-out, contact NERC IT support directly at <https://support.nerc.net/> (Monday – Friday, 8 a.m. - 5 p.m. Eastern).*
- *Passwords expire every **6 months** and must be reset.*
- *The SBS **is not** supported for use on mobile devices.*
- *Please be mindful of ballot and comment period closing dates. We ask to **allow at least 48 hours** for NERC support staff to assist with inquiries. Therefore, it is recommended that users try logging into their SBS accounts **prior to the last day** of a comment/ballot period.*

### Next Steps

Initial ballots for the standard and non-binding polls of the associated Violation Risk Factors and Violation Severity Levels will be conducted **September 28 – October 9, 2018**.



For information on the Standards Development Process, refer to the [Standard Processes Manual](#).

For more information or assistance, contact Standards Developer, [Jordan Mallory](#) (via email) or at (404) 446-2589.

North American Electric Reliability Corporation  
3353 Peachtree Rd, NE  
Suite 600, North Tower  
Atlanta, GA 30326  
404-446-2560 | [www.nerc.com](http://www.nerc.com)

## Comment Report

**Project Name:** 2016-02 Modifications to CIP Standards | CIP-003-8  
**Comment Period Start Date:** 8/23/2018  
**Comment Period End Date:** 10/9/2018  
**Associated Ballots:** 2016-02 Modifications to CIP Standards CIP-003-8 Draft 1 IN 1 ST

There were 50 sets of responses, including comments from approximately 131 different people from approximately 92 companies representing 10 of the Industry Segments as shown in the table on the following pages.

## Questions

- 1. Requirement R2, Attachment 1, Section 5.2:** In response to the directive in FERC Order 843, the SDT modified Attachment 1, Section 5.2 adding subsection 5.2.2 to state: “For any method used pursuant to 5.2.1, Responsible Entities shall determine whether any additional mitigation actions are necessary and implement such actions prior to connecting the Transient Cyber Asset.” Do you agree with this revision? If not, please provide the basis for your disagreement and an alternate proposal.
- 2. Guidelines and Technical Basis:** The SDT made changes to the Guidelines and Technical Basis section of the Standard to conform with the modifications it made to Attachment 1, Section 5.2. Do you agree with these changes to the Guidelines and Technical Basis? If not, please provide the basis for your disagreement and an alternate proposal. (The CIP SDT is aware that another initiative is underway to convert all GTB sections to Technical Rationale documents. This effort is outside the scope of this SDT.)
- 3. Implementation Plan:** The SDT established the Implementation Plan to make the standard effective the later of (1) January 1, 2020, or (2) the first day of the first calendar quarter that is six (6) calendar months after the effective date of the applicable governmental authority’s order approving the standard, or as otherwise provided for by the applicable governmental authority. Do you agree with this proposal? If you think an alternate effective date is needed, please provide a detailed explanation of actions and time needed.
- 4. The SDT believes proposed modifications in CIP-003-8 provide entities with flexibility to meet the reliability objectives in a cost effective manner. Do you agree? If you do not agree, or if you agree but have suggestions for improvement to enable more cost effective approaches, please provide your recommendation and, if appropriate, technical or procedural justification.**

Organization Name	Name	Segment(s)	Region	Group Name	Group Member Name	Group Member Organization	Group Member Segment(s)	Group Member Region
Santee Cooper	Chris Wagner	1		Santee Cooper	Rene' Free	Santee Cooper	1,3,5,6	SERC
					Rodger Blakely	Santee Cooper	1,3,5,6	SERC
					Troy Lee	Santee Cooper	1,3,5,6	SERC
					Jennifer Richards	Santee Cooper	1,3,5,6	SERC
					Chris Jimenez	Santee Cooper	1,3,5,6	SERC
Duke Energy	Colby Bellville	1,3,5,6	FRCC,RF,SERC	Duke Energy	Doug Hils	Duke Energy	1	RF
					Lee Schuster	Duke Energy	3	FRCC
					Dale Goodwine	Duke Energy	5	SERC
					Greg Cecil	Duke Energy	6	RF
MRO	Dana Klem	1,2,3,4,5,6	MRO	MRO NSRF	Joseph DePoorter	Madison Gas & Electric	3,4,5,6	MRO
					Larry Heckert	Alliant Energy	4	MRO
					Amy Casucelli	Xcel Energy	1,3,5,6	MRO
					Michael Brytowski	Great River Energy	1,3,5,6	MRO
					Jodi Jensen	Western Area Power Administration	1,6	MRO
					Kayleigh Wilkerson	Lincoln Electric System	1,3,5,6	MRO
					Mahmood Safi	Omaha Public Power District	1,3,5,6	MRO
					Brad Parret	Minnesota Power	1,5	MRO
					Terry Harbour	MidAmerican Energy Company	1,3	MRO
					Tom Breene	Wisconsin Public Service Corporation	3,5,6	MRO

					Jeremy Voll	Basin Electric Power Cooperative	1	MRO
					Kevin Lyons	Central Iowa Power Cooperative	1	MRO
					Mike Morrow	Midcontinent ISO	2	MRO
PPL - Louisville Gas and Electric Co.	Devin Shines	1,3,5,6	RF,SERC	PPL NERC Registered Affiliates	Brenda Truhe	PPL Electric Utilities Corporation	1	RF
					Charles Freibert	PPL - Louisville Gas and Electric Co.	3	SERC
					JULIE HOSTRANDER	PPL - Louisville Gas and Electric Co.	5	SERC
					Linn Oelker	PPL - Louisville Gas and Electric Co.	6	SERC
ACES Power Marketing	Jodirah Green	6	NA - Not Applicable	ACES Standard Collaborations	Shari Heino	Brazos Electric Power Cooperative, Inc.	5	Texas RE
					John Shaver	Arizona Electric Power Cooperative, Inc.	1	WECC
					Joseph Smith	Prairie Power	3	SERC
					Susan Sosbe	Wabash Valley Power Association	3	RF
					Bob Solomon	Hoosier Energy Rural Electric Cooperative, Inc.	1	SERC
					Tara Lightner	Sunflower Electric Power Corporation	1	MRO
FirstEnergy - FirstEnergy Corporation	Julie Severino	1		FirstEnergy	Aubrey Short	FirstEnergy - FirstEnergy Corporation	4	RF

					Aaron Ghodooshim	FirstEnergy - FirstEnergy Corporation	3	RF
					Robert Loy	FirstEnergy - FirstEnergy Solutions	5	RF
					Ann Ivanc	FirstEnergy - FirstEnergy Solutions	6	RF
Southern Company - Southern Company Services, Inc.	Pamela Hunter	1,3,5,6	SERC	Southern Company	Katherine Prewitt	Southern Company Services, Inc.	1	SERC
					Joel Dembowski	Southern Company - Alabama Power Company	3	SERC
					William D. Shultz	Southern Company Generation	5	SERC
					Jennifer G. Sykes	Southern Company Generation and Energy Marketing	6	SERC
Northeast Power Coordinating Council	Ruida Shu	1,2,3,4,5,6,7,8,9,10	NPCC	RSC no Dominion and HQ	Guy V. Zito	Northeast Power Coordinating Council	10	NPCC
					Randy MacDonald	New Brunswick Power	2	NPCC
					Wayne Sipperly	New York Power Authority	4	NPCC
					Glen Smith	Entergy Services	4	NPCC
					Brian Robinson	Utility Services	5	NPCC
					Alan Adamson	New York State Reliability Council	7	NPCC
					Edward Bedder	Orange & Rockland Utilities	1	NPCC

David Burke	Orange & Rockland Utilities	3	NPCC
Michele Tondalo	UI	1	NPCC
Laura Mcleod	NB Power	1	NPCC
David Ramkalawan	Ontario Power Generation Inc.	5	NPCC
Helen Lainis	IESO	2	NPCC
Michael Schiavone	National Grid	1	NPCC
Michael Jones	National Grid	3	NPCC
Michael Forte	Con Ed - Consolidated Edison	1	NPCC
Peter Yost	Con Ed - Consolidated Edison Co. of New York	3	NPCC
Sean Cavote	PSEG	4	NPCC
Kathleen Goodman	ISO-NE	2	NPCC
Quintin Lee	Eversource Energy	1	NPCC
Dermot Smyth	Con Ed - Consolidated Edison Co. of New York	1,5	NPCC
Salvatore Spagnolo	New York Power Authority	1	NPCC
Shivaz Chopra	New York Power Authority	6	NPCC
David Kiguel	Independent	NA - Not Applicable	NPCC
Silvia Mitchell	NextEra Energy - Florida Power and Light Co.	6	NPCC
Paul Malozewski	Hydro One Networks, Inc.	3	NPCC
Gregory Campoli	New York Independent	2	NPCC

						System Operator		
Associated Electric Cooperative, Inc.	Todd Bennett	3		AECI	Michael Bax	Central Electric Power Cooperative (Missouri)	1	SERC
					Adam Weber	Central Electric Power Cooperative (Missouri)	3	SERC
					Stephen Pogue	M and A Electric Power Cooperative	3	SERC
					William Price	M and A Electric Power Cooperative	1	SERC
					Jeff Neas	Sho-Me Power Electric Cooperative	3	SERC
					Peter Dawson	Sho-Me Power Electric Cooperative	1	SERC
					Mark Ramsey	N.W. Electric Power Cooperative, Inc.	1	NPCC
					John Stickley	NW Electric Power Cooperative, Inc.	3	SERC
					Ted Hilmes	KAMO Electric Cooperative	3	SERC
					Walter Kenyon	KAMO Electric Cooperative	1	SERC
					Kevin White	Northeast Missouri Electric Power Cooperative	1	SERC
					Skyler Wiegmann	Northeast Missouri Electric Power Cooperative	3	SERC
					Ryan Ziegler	Associated Electric Cooperative, Inc.	1	SERC



					Brian Ackermann	Associated Electric Cooperative, Inc.	6	SERC
					Brad Haralson	Associated Electric Cooperative, Inc.	5	SERC

1. Requirement R2, Attachment 1, Section 5.2: In response to the directive in FERC Order 843, the SDT modified Attachment 1, Section 5.2 adding subsection 5.2.2 to state: “For any method used pursuant to 5.2.1, Responsible Entities shall determine whether any additional mitigation actions are necessary and implement such actions prior to connecting the Transient Cyber Asset.” Do you agree with this revision? If not, please provide the basis for your disagreement and an alternate proposal.

Dana Klem - MRO - 1,2,3,4,5,6 - MRO, Group Name MRO NSRF

Answer No

Document Name

Comment

The NSRF recommends the following change for clarity to the draft 5.2.2 (added text is bracketed) “For any method used pursuant to 5.2.1, Responsible Entities shall determine whether any additional mitigation actions are necessary and[, if any,] implement such actions prior to connecting the Transient Cyber Asset.”

Likes 0

Dislikes 0

Response

Richard Jackson - U.S. Bureau of Reclamation - 1

Answer No

Document Name

Comment

The proposed language is too vague, will not add value, and is not auditable. Reclamation recommends any changes pertaining to low impact TCA and RM should align with CIP-010 Attachment 1 and provide equal or less stringent controls for low impact BES Cyber Systems as for medium and high impact BES Cyber Systems.

Likes 0

Dislikes 0

Response

Laura Nelson - IDACORP - Idaho Power Company - 1

Answer No

Document Name

Comment

Idaho Power Company does not believe that this is an auditable approach by the way the standards are written. A Responsible Entity that believed any additional mitigation actions were necessary would implement those additional measures. Stating the requirements in this manner seems vague and lacks the auditability of a normal requirement. It would be more appropriate to have a Responsible Entity document the steps that were taken prior to allowing a third party to connect a TCA.

Likes 0

Dislikes 0

### Response

#### Eric Ruskamp - Lincoln Electric System - 6

Answer

No

Document Name

#### Comment

LES supports the NSRF comments:

The NSRF recommends the following change for clarity to the draft 5.2.2 (added text is bracketed) "For any method used pursuant to 5.2.1, Responsible Entities shall determine whether any additional mitigation actions are necessary and[, if any,] implement such actions prior to connecting the Transient Cyber Asset."

Likes 0

Dislikes 0

### Response

#### Tyson Archie - Platte River Power Authority - 5

Answer

No

Document Name

#### Comment

There appears to be a disconnect between the intent as noted in the Guidelines and Technical Basis and the requirement documented in CIP-003-8, Attachment 1, 5.2.2. The intent is that, "if there are deficiencies identified" then mitigation actions must be completed. The requirement does not contain the 'if then' syntax.

Consider revising 5.2.2 as follows:

If deficiencies are identified for any method used pursuant to 5.2.1, then the Responsible Entity shall implement mitigation actions to address the deficiencies prior to connecting the Transient Cyber Asset.

Consider revising CIP-003-8, Attachment 2, Section 5 (2) as follows:

Examples of evidence for Attachment 1, Section 5.2.2 may include, but are not limited to, documentation from change management systems, electronic mail, or contracts that identify mitigation actions that were implemented prior to connecting the Transient Cyber Asset managed by a party and that were implemented to address deficiencies of any method used pursuant to 5.2.1

Likes 0

Dislikes 0

### Response

**Larry Watt - Lakeland Electric - 1**

**Answer**

No

**Document Name**

**Comment**

The proposed language is too vague, will not add value, and is not auditable. Reclamation recommends any changes pertaining to low impact TCA and RM should align with CIP-010 Attachment 1 and provide equal controls for low impact BES Cyber Systems as for medium and high impact BES Cyber Systems.

Likes 0

Dislikes 0

### Response

**Andy Fuhrman - Andy Fuhrman On Behalf of: Theresa Allard, Minnkota Power Cooperative Inc., 1; - Andy Fuhrman**

**Answer**

No

**Document Name**

**Comment**

Please refer to comments from the MRO NERC Standards Review Forum (NSRF).

Likes 0

Dislikes 0

### Response

**Stephanie Burns - Stephanie Burns On Behalf of: Michael Moltane, International Transmission Company Holdings Corporation, 1; - Stephanie Burns**

**Answer**

No

**Document Name**

**Comment**

ITC is in agreement with statements made by the NSRF:

The NSRF recommends the following change for clarity to the draft 5.2.2 (added text is bracketed) "For any method used pursuant to 5.2.1, Responsible Entities shall determine whether any additional mitigation actions are necessary and[, if any,] implement such actions prior to connecting the Transient Cyber Asset."

Likes 0

Dislikes 0

### Response

**Andrey Komissarov - Andrey Komissarov On Behalf of: Daniel Frank, Sempra - San Diego Gas and Electric, 3, 5, 1; - Andrey Komissarov**

**Answer** No

**Document Name**

### Comment

The final bullet of 5.2.1 "Other method(s) to mitigate the introduction of malicious code" addresses the issue. If the entity deems it necessary to use another method, they already have this provision in place. Section 5.2.2 only confuses the matter.

Likes 0

Dislikes 0

### Response

**Aaron Cavanaugh - Bonneville Power Administration - 1,3,5,6 - WECC**

**Answer** Yes

**Document Name**

### Comment

None

Likes 0

Dislikes 0

### Response

**Anthony Jablonski - ReliabilityFirst - 10**

**Answer** Yes

<b>Document Name</b>	
<b>Comment</b>	
ReliabilityFirst agrees with the proposed modification.	
Likes 0	
Dislikes 0	
<b>Response</b>	
<b>Barry Lawson - National Rural Electric Cooperative Association - 4</b>	
<b>Answer</b>	Yes
<b>Document Name</b>	
<b>Comment</b>	
NRECA recommends the following change for clarity to the draft 5.2.2 (added text is bracketed) "For any method used pursuant to 5.2.1, Responsible Entities shall determine whether any additional mitigation actions are necessary and[, if any,] implement such actions prior to connecting the Transient Cyber Asset."	
Likes 0	
Dislikes 0	
<b>Response</b>	
<b>Lana Smith - San Miguel Electric Cooperative, Inc. - 5 - Texas RE</b>	
<b>Answer</b>	Yes
<b>Document Name</b>	
<b>Comment</b>	
SMEC agrees with NRECA Comment:  recommends the following change for clarity to the draft 5.2.2 (added text is bracketed) "For any method used pursuant to 5.2.1, Responsible Entities shall determine whether any additional mitigation actions are necessary and[, if any,] implement such actions prior to connecting the Transient Cyber Asset."	
Likes 0	
Dislikes 0	
<b>Response</b>	
<b>Andrea Barclay - Georgia System Operations Corporation - 4</b>	

Answer	Yes
Document Name	
<b>Comment</b>	
<p>Recommends the following change for clarity to the draft 5.2.2 (added text is bracketed) "For any method used pursuant to 5.2.1, Responsible Entities shall determine whether any additional mitigation actions are necessary and[, if any,] implement such actions prior to connecting the Transient Cyber Asset."</p>	
Likes	0
Dislikes	0
<b>Response</b>	
<p><b>Joe Tarantino - Joe Tarantino On Behalf of: Arthur Starkovich, Sacramento Municipal Utility District, 4, 1, 5, 6, 3; Beth Tincher, Sacramento Municipal Utility District, 4, 1, 5, 6, 3; Jamie Cutlip, Sacramento Municipal Utility District, 4, 1, 5, 6, 3; Kevin Smith, Balancing Authority of Northern California, 1; Nicole Looney, Sacramento Municipal Utility District, 4, 1, 5, 6, 3; Susan Oto, Sacramento Municipal Utility District, 4, 1, 5, 6, 3; - Joe Tarantino</b></p>	
Answer	Yes
Document Name	
<b>Comment</b>	
Likes	0
Dislikes	0
<b>Response</b>	
<p><b>Chris Wagner - Santee Cooper - 1, Group Name Santee Cooper</b></p>	
Answer	Yes
Document Name	
<b>Comment</b>	
Likes	0
Dislikes	0
<b>Response</b>	
<p><b>Devin Shines - PPL - Louisville Gas and Electric Co. - 1,3,5,6 - SERC,RF, Group Name PPL NERC Registered Affiliates</b></p>	
Answer	Yes

<b>Document Name</b>	
<b>Comment</b>	
Likes 0	
Dislikes 0	
<b>Response</b>	
<b>Julie Severino - FirstEnergy - FirstEnergy Corporation - 1, Group Name FirstEnergy</b>	
<b>Answer</b>	Yes
<b>Document Name</b>	
<b>Comment</b>	
Likes 0	
Dislikes 0	
<b>Response</b>	
<b>Leanna Lamatrice - AEP - 3</b>	
<b>Answer</b>	Yes
<b>Document Name</b>	
<b>Comment</b>	
Likes 0	
Dislikes 0	
<b>Response</b>	
<b>Jeanne Kurzynowski - CMS Energy - Consumers Energy Company - 1,3,4,5 - RF</b>	
<b>Answer</b>	Yes
<b>Document Name</b>	
<b>Comment</b>	
Likes 0	
Dislikes 0	



**Response**

**James Anderson - CMS Energy - Consumers Energy Company - 1**

**Answer** Yes

**Document Name**

**Comment**

Likes 0

Dislikes 0

**Response**

**Dennis Sismaet - Northern California Power Agency - 6**

**Answer** Yes

**Document Name**

**Comment**

Likes 0

Dislikes 0

**Response**

**Vivian Vo - APS - Arizona Public Service Co. - 3**

**Answer** Yes

**Document Name**

**Comment**

Likes 0

Dislikes 0

**Response**

**Kevin Salsbury - Berkshire Hathaway - NV Energy - 5**

**Answer** Yes

**Document Name**

**Comment**

Likes 0

Dislikes 0

**Response****Russell Martin II - Salt River Project - 1,3,5,6 - WECC****Answer**

Yes

**Document Name****Comment**

Likes 0

Dislikes 0

**Response****Karl Blaszkowski - CMS Energy - Consumers Energy Company - 3****Answer**

Yes

**Document Name****Comment**

Likes 0

Dislikes 0

**Response****Heather Morgan - EDP Renewables North America LLC - 5****Answer**

Yes

**Document Name****Comment**

Likes 0

Dislikes 0

**Response**

**faranak sarbaz - Los Angeles Department of Water and Power - 1**

**Answer** Yes

**Document Name**

**Comment**

Likes 0

Dislikes 0

**Response**

**Nicholas Lauriat - Network and Security Technologies - 1**

**Answer** Yes

**Document Name**

**Comment**

Likes 0

Dislikes 0

**Response**

**Colby Bellville - Duke Energy - 1,3,5,6 - FRCC,SERC,RF, Group Name Duke Energy**

**Answer** Yes

**Document Name**

**Comment**

Likes 0

Dislikes 0

**Response**

**Anton Vu - Los Angeles Department of Water and Power - 6**

**Answer** Yes

**Document Name**

**Comment**

Likes 0

Dislikes 0

**Response**

**Ruida Shu - Northeast Power Coordinating Council - 1,2,3,4,5,6,7,8,9,10 - NPCC, Group Name RSC no Dominion and HQ**

**Answer**

Yes

**Document Name**

**Comment**

Likes 0

Dislikes 0

**Response**

**Douglas Johnson - American Transmission Company, LLC - 1**

**Answer**

Yes

**Document Name**

**Comment**

Likes 0

Dislikes 0

**Response**

**Sandra Shaffer - Berkshire Hathaway - PacifiCorp - 6**

**Answer**

Yes

**Document Name**

**Comment**

Likes 0

Dislikes 0

**Response**

**Jodirah Green - ACES Power Marketing - 6, Group Name ACES Standard Collaborations**

**Answer** Yes

**Document Name**

**Comment**

Likes 0

Dislikes 0

**Response**

**Maryanne Darling-Reich - Black Hills Corporation - 1,3,5,6 - WECC**

**Answer** Yes

**Document Name**

**Comment**

Likes 0

Dislikes 0

**Response**

**Leonard Kula - Independent Electricity System Operator - 2**

**Answer** Yes

**Document Name**

**Comment**

Likes 0

Dislikes 0

**Response**

**Tho Tran - Tho Tran On Behalf of: Lee Maurer, Oncor Electric Delivery, 1; - Tho Tran**

**Answer** Yes

**Document Name**

**Comment**

Likes 0

Dislikes 0

**Response**

**Rachel Coyne - Texas Reliability Entity, Inc. - 10**

**Answer**

Yes

**Document Name**

**Comment**

Likes 0

Dislikes 0

**Response**

**David Jendras - Ameren - Ameren Services - 3**

**Answer**

Yes

**Document Name**

**Comment**

Likes 0

Dislikes 0

**Response**

**Eli Rivera - Central Electric Cooperative, Inc. (Redmond, Oregon) - 1 - Texas RE**

**Answer**

Yes

**Document Name**

**Comment**

Likes 0

Dislikes 0

**Response**

**William Sanders - Lower Colorado River Authority - 1**

Answer	Yes
Document Name	
<b>Comment</b>	
Likes 0	
Dislikes 0	
<b>Response</b>	
<b>Douglas Webb - Douglas Webb On Behalf of: Allen Klassen, Westar Energy, 6, 3, 1, 5; Bryan Taggart, Westar Energy, 6, 3, 1, 5; Derek Brown, Westar Energy, 6, 3, 1, 5; Grant Wilkerson, Westar Energy, 6, 3, 1, 5; Harold Wyble, Great Plains Energy - Kansas City Power and Light Co., 5, 1, 3, 6; James McBee, Great Plains Energy - Kansas City Power and Light Co., 5, 1, 3, 6; Jennifer Flandermeyer, Great Plains Energy - Kansas City Power and Light Co., 5, 1, 3, 6; John Carlson, Great Plains Energy - Kansas City Power and Light Co., 5, 1, 3, 6; - Douglas Webb</b>	
Answer	Yes
Document Name	
<b>Comment</b>	
Likes 0	
Dislikes 0	
<b>Response</b>	
<b>Amber Orr - Public Utility District No. 1 of Pend Oreille County - 3</b>	
Answer	Yes
Document Name	
<b>Comment</b>	
Likes 0	
Dislikes 0	
<b>Response</b>	
<b>Pamela Hunter - Southern Company - Southern Company Services, Inc. - 1,3,5,6 - SERC, Group Name Southern Company</b>	
Answer	Yes
Document Name	
<b>Comment</b>	

Likes 0

Dislikes 0

**Response**

**Ryan Walter - Tri-State G and T Association, Inc. - 1,3,5 - MRO,WECC**

**Answer**

Yes

**Document Name**

**Comment**

Likes 0

Dislikes 0

**Response**

**Constantin Chitescu - Ontario Power Generation Inc. - 5**

**Answer**

Yes

**Document Name**

**Comment**

Likes 0

Dislikes 0

**Response**

**Chris Scanlon - Exelon - 1**

**Answer**

Yes

**Document Name**

**Comment**

Likes 0

Dislikes 0

**Response**



<b>Todd Bennett - Associated Electric Cooperative, Inc. - 3, Group Name AECI</b>	
<b>Answer</b>	
<b>Document Name</b>	
<b>Comment</b>	
AECI supports the comments provided by NRECA.	
Likes 0	
Dislikes 0	
<b>Response</b>	

**2. Guidelines and Technical Basis: The SDT made changes to the Guidelines and Technical Basis section of the Standard to conform with the modifications it made to Attachment 1, Section 5.2. Do you agree with these changes to the Guidelines and Technical Basis? If not, please provide the basis for your disagreement and an alternate proposal. (The CIP SDT is aware that another initiative is underway to convert all GTB sections to Technical Rationale documents. This effort is outside the scope of this SDT.)**

**Stephanie Burns - Stephanie Burns On Behalf of: Michael Moltane, International Transmission Company Holdings Corporation, 1; - Stephanie Burns**

**Answer** No

**Document Name**

**Comment**

ITC is in agreement with statements made by the NSRF:

The NSRF request that the entire Guideline and Technical Basis section should be removed from the Standard as it may be interpreted as how to meet the Compliance obligations of the Requirements. FERC Order 693 section 253 states, "The most critical element of a Reliability Standard is the Requirements. As NERC explains, "the Requirements within a standard define what an entity must do to be compliant . . . [and] binds an entity to certain obligations of performance under section 215 of the FPA." This information should reside out side the Standard as a NERC Compliance Guidance document.

Likes 0

Dislikes 0

**Response**

**Andy Fuhrman - Andy Fuhrman On Behalf of: Theresa Allard, Minnkota Power Cooperative Inc., 1; - Andy Fuhrman**

**Answer** No

**Document Name**

**Comment**

Please refer to comments from the MRO NERC Standards Review Forum (NSRF).

Likes 0

Dislikes 0

**Response**

**Larry Watt - Lakeland Electric - 1**

**Answer** No

**Document Name**

**Comment**

The Guidelines and Technical Bases states contracts and vendor change management informatino would serve as evidence, but, in the experience of Lakeland Electric, providing procedural or contractual evidence does not seem to be a satisfactory evidence artifact to provide to the auditors when they are asking for evidence that a task was performed. The way it is written makes the auditability vague and subject to a lot of judgement which can create frustration for Responsible Entities if that approach is not consistent.

Likes 0

Dislikes 0

### Response

**Laura Nelson - IDACORP - Idaho Power Company - 1**

**Answer**

No

**Document Name**

**Comment**

The Guidelines and Technical Bases states contracts would serve as evidence, but, in the experience of Idaho Power Company, providing procedural or contractual evidence does not seem to be a satisfactory evidence artifact to provide to the auditors when they are asking for evidence that a task was performed prior to connecting a TCA they often require something that shows a task was performed. The way it is written makes the auditability vague and subject to a lot of judgement which can create frustration for Responsible Entities if that approach is not consistent.

Likes 0

Dislikes 0

### Response

**Dana Klem - MRO - 1,2,3,4,5,6 - MRO, Group Name MRO NSRF**

**Answer**

No

**Document Name**

**Comment**

The NSRF request that the entire Guideline and Technical Basis section should be removed from the Standard as it may be interpreted as how to meet the Compliance obligations of the Requirements. FERC Order 693 section 253 states, "The most critical element of a Reliability Standard is the Requirements. As NERC explains, "the Requirements within a standard define what an entity must do to be compliant . . . [and] binds an entity to certain obligations of performance under section 215 of the FPA." This information should reside out side the Standard as a NERC Compliance Guidance document.

Likes 0

Dislikes 0

### Response

**Tyson Archie - Platte River Power Authority - 5**

<b>Answer</b>	Yes
---------------	-----

<b>Document Name</b>	
----------------------	--

**Comment**

There appears to be a disconnect between the intent as noted in the Guidelines and Technical Basis and the requirement documented in CIP-003-8, Attachment 1, 5.2.2. See Comment for Q1.

Likes 0	
---------	--

Dislikes 0	
------------	--

**Response****Anthony Jablonski - ReliabilityFirst - 10**

<b>Answer</b>	Yes
---------------	-----

<b>Document Name</b>	
----------------------	--

**Comment**

ReliabilityFirst agrees with the proposed modification.

Likes 0	
---------	--

Dislikes 0	
------------	--

**Response****Aaron Cavanaugh - Bonneville Power Administration - 1,3,5,6 - WECC**

<b>Answer</b>	Yes
---------------	-----

<b>Document Name</b>	
----------------------	--

**Comment**

None

Likes 0	
---------	--

Dislikes 0	
------------	--

**Response****Chris Scanlon - Exelon - 1**

<b>Answer</b>	Yes
---------------	-----

<b>Document Name</b>	
<b>Comment</b>	
Likes 0	
Dislikes 0	
<b>Response</b>	
<b>Constantin Chitescu - Ontario Power Generation Inc. - 5</b>	
<b>Answer</b>	Yes
<b>Document Name</b>	
<b>Comment</b>	
Likes 0	
Dislikes 0	
<b>Response</b>	
<b>Ryan Walter - Tri-State G and T Association, Inc. - 1,3,5 - MRO,WECC</b>	
<b>Answer</b>	Yes
<b>Document Name</b>	
<b>Comment</b>	
Likes 0	
Dislikes 0	
<b>Response</b>	
<b>Pamela Hunter - Southern Company - Southern Company Services, Inc. - 1,3,5,6 - SERC, Group Name Southern Company</b>	
<b>Answer</b>	Yes
<b>Document Name</b>	
<b>Comment</b>	
Likes 0	
Dislikes 0	

**Response**

**Amber Orr - Public Utility District No. 1 of Pend Oreille County - 3**

**Answer** Yes

**Document Name**

**Comment**

Likes 0

Dislikes 0

**Response**

**Douglas Webb - Douglas Webb On Behalf of: Allen Klassen, Westar Energy, 6, 3, 1, 5; Bryan Taggart, Westar Energy, 6, 3, 1, 5; Derek Brown, Westar Energy, 6, 3, 1, 5; Grant Wilkerson, Westar Energy, 6, 3, 1, 5; Harold Wyble, Great Plains Energy - Kansas City Power and Light Co., 5, 1, 3, 6; James McBee, Great Plains Energy - Kansas City Power and Light Co., 5, 1, 3, 6; Jennifer Flandermeyer, Great Plains Energy - Kansas City Power and Light Co., 5, 1, 3, 6; John Carlson, Great Plains Energy - Kansas City Power and Light Co., 5, 1, 3, 6; - Douglas Webb**

**Answer** Yes

**Document Name**

**Comment**

Likes 0

Dislikes 0

**Response**

**William Sanders - Lower Colorado River Authority - 1**

**Answer** Yes

**Document Name**

**Comment**

Likes 0

Dislikes 0

**Response**

**Eli Rivera - Central Electric Cooperative, Inc. (Redmond, Oregon) - 1 - Texas RE**

Answer	Yes
Document Name	
Comment	
Likes 0	
Dislikes 0	
Response	
Andrey Komissarov - Andrey Komissarov On Behalf of: Daniel Frank, Sempra - San Diego Gas and Electric, 3, 5, 1; - Andrey Komissarov	
Answer	Yes
Document Name	
Comment	
Likes 0	
Dislikes 0	
Response	
David Jendras - Ameren - Ameren Services - 3	
Answer	Yes
Document Name	
Comment	
Likes 0	
Dislikes 0	
Response	
Rachel Coyne - Texas Reliability Entity, Inc. - 10	
Answer	Yes
Document Name	
Comment	
Likes 0	

Dislikes 0

**Response**

**Tho Tran - Tho Tran On Behalf of: Lee Maurer, Oncor Electric Delivery, 1; - Tho Tran**

**Answer** Yes

**Document Name**

**Comment**

Likes 0

Dislikes 0

**Response**

**Lana Smith - San Miguel Electric Cooperative, Inc. - 5 - Texas RE**

**Answer** Yes

**Document Name**

**Comment**

Likes 0

Dislikes 0

**Response**

**Leonard Kula - Independent Electricity System Operator - 2**

**Answer** Yes

**Document Name**

**Comment**

Likes 0

Dislikes 0

**Response**

**Maryanne Darling-Reich - Black Hills Corporation - 1,3,5,6 - WECC**

**Answer** Yes



<b>Document Name</b>	
<b>Comment</b>	
Likes 0	
Dislikes 0	
<b>Response</b>	
<b>Jodirah Green - ACES Power Marketing - 6, Group Name ACES Standard Collaborations</b>	
<b>Answer</b>	Yes
<b>Document Name</b>	
<b>Comment</b>	
Likes 0	
Dislikes 0	
<b>Response</b>	
<b>Sandra Shaffer - Berkshire Hathaway - PacifiCorp - 6</b>	
<b>Answer</b>	Yes
<b>Document Name</b>	
<b>Comment</b>	
Likes 0	
Dislikes 0	
<b>Response</b>	
<b>Douglas Johnson - American Transmission Company, LLC - 1</b>	
<b>Answer</b>	Yes
<b>Document Name</b>	
<b>Comment</b>	
Likes 0	
Dislikes 0	

**Response**

**Ruida Shu - Northeast Power Coordinating Council - 1,2,3,4,5,6,7,8,9,10 - NPCC, Group Name RSC no Dominion and HQ**

**Answer** Yes

**Document Name**

**Comment**

Likes 0

Dislikes 0

**Response**

**Anton Vu - Los Angeles Department of Water and Power - 6**

**Answer** Yes

**Document Name**

**Comment**

Likes 0

Dislikes 0

**Response**

**Colby Bellville - Duke Energy - 1,3,5,6 - FRCC,SERC,RF, Group Name Duke Energy**

**Answer** Yes

**Document Name**

**Comment**

Likes 0

Dislikes 0

**Response**

**Nicholas Lauriat - Network and Security Technologies - 1**

**Answer** Yes

**Document Name**

**Comment**

Likes 0

Dislikes 0

**Response****faranak sarbaz - Los Angeles Department of Water and Power - 1****Answer**

Yes

**Document Name****Comment**

Likes 0

Dislikes 0

**Response****Heather Morgan - EDP Renewables North America LLC - 5****Answer**

Yes

**Document Name****Comment**

Likes 0

Dislikes 0

**Response****Karl Blaszkowski - CMS Energy - Consumers Energy Company - 3****Answer**

Yes

**Document Name****Comment**

Likes 0

Dislikes 0

**Response**

**Russell Martin II - Salt River Project - 1,3,5,6 - WECC**

Answer Yes

Document Name

Comment

Likes 0

Dislikes 0

Response

**Kevin Salsbury - Berkshire Hathaway - NV Energy - 5**

Answer Yes

Document Name

Comment

Likes 0

Dislikes 0

Response

**Vivian Vo - APS - Arizona Public Service Co. - 3**

Answer Yes

Document Name

Comment

Likes 0

Dislikes 0

Response

**Eric Ruskamp - Lincoln Electric System - 6**

Answer Yes

Document Name

Comment

Likes 0

Dislikes 0

**Response**

**Dennis Sismaet - Northern California Power Agency - 6**

**Answer**

Yes

**Document Name**

**Comment**

Likes 0

Dislikes 0

**Response**

**Richard Jackson - U.S. Bureau of Reclamation - 1**

**Answer**

Yes

**Document Name**

**Comment**

Likes 0

Dislikes 0

**Response**

**James Anderson - CMS Energy - Consumers Energy Company - 1**

**Answer**

Yes

**Document Name**

**Comment**

Likes 0

Dislikes 0

**Response**

**Leanna Lamatrice - AEP - 3**

**Answer** Yes

**Document Name**

**Comment**

Likes 0

Dislikes 0

**Response**

**Julie Severino - FirstEnergy - FirstEnergy Corporation - 1, Group Name** FirstEnergy

**Answer** Yes

**Document Name**

**Comment**

Likes 0

Dislikes 0

**Response**

**Devin Shines - PPL - Louisville Gas and Electric Co. - 1,3,5,6 - SERC,RF, Group Name** PPL NERC Registered Affiliates

**Answer** Yes

**Document Name**

**Comment**

Likes 0

Dislikes 0

**Response**

**Chris Wagner - Santee Cooper - 1, Group Name** Santee Cooper

**Answer** Yes

**Document Name**

**Comment**

Likes	0
Dislikes	0
<b>Response</b>	
<p><b>Joe Tarantino - Joe Tarantino On Behalf of: Arthur Starkovich, Sacramento Municipal Utility District, 4, 1, 5, 6, 3; Beth Tincher, Sacramento Municipal Utility District, 4, 1, 5, 6, 3; Jamie Cutlip, Sacramento Municipal Utility District, 4, 1, 5, 6, 3; Kevin Smith, Balancing Authority of Northern California, 1; Nicole Looney, Sacramento Municipal Utility District, 4, 1, 5, 6, 3; Susan Oto, Sacramento Municipal Utility District, 4, 1, 5, 6, 3; - Joe Tarantino</b></p>	
Answer	Yes
Document Name	
<b>Comment</b>	
Likes	0
Dislikes	0
<b>Response</b>	
<p><b>Todd Bennett - Associated Electric Cooperative, Inc. - 3, Group Name AECI</b></p>	
Answer	
Document Name	
<b>Comment</b>	
<p>AECI supports the comments provided by NRECA.</p>	
Likes	0
Dislikes	0
<b>Response</b>	

3. Implementation Plan: The SDT established the Implementation Plan to make the standard effective the later of (1) January 1, 2020, or (2) the first day of the first calendar quarter that is six (6) calendar months after the effective date of the applicable governmental authority's order approving the standard, or as otherwise provided for by the applicable governmental authority. Do you agree with this proposal? If you think an alternate effective date is needed, please provide a detailed explanation of actions and time needed.

Joe Tarantino - Joe Tarantino On Behalf of: Arthur Starkovich, Sacramento Municipal Utility District, 4, 1, 5, 6, 3; Beth Tincher, Sacramento Municipal Utility District, 4, 1, 5, 6, 3; Jamie Cutlip, Sacramento Municipal Utility District, 4, 1, 5, 6, 3; Kevin Smith, Balancing Authority of Northern California, 1; Nicole Looney, Sacramento Municipal Utility District, 4, 1, 5, 6, 3; Susan Oto, Sacramento Municipal Utility District, 4, 1, 5, 6, 3; - Joe Tarantino

Answer No

Document Name

Comment

Attachment 2 Section 5 part 2 indicates that contracts must be modified. Contract may take over 6 months to modify. Consider changing the implementation to span 12 months.

Likes 0

Dislikes 0

Response

Richard Jackson - U.S. Bureau of Reclamation - 1

Answer No

Document Name

Comment

Reclamation recommends CIP-003-8 become effective no earlier than 18 calendar months after the effective date of the applicable governmental authority's order approving the standard.

Likes 0

Dislikes 0

Response

Dennis Sismaet - Northern California Power Agency - 6

Answer No

Document Name



**Comment**

Since CIP-003-8 incorporates the same language for Planned and Unplanned Changes in Section 5, as in the proposed CIP-002-6 standard, the revised standard should become effective the first day of the first calendar quarter that is twenty-four (24) calendar months after the effective date of the applicable governmental authority's order approving the standard.

This is to allow additional needed time for entities to prepare, plan, budget, procure, and hire additional labor resources to meet all the applicable reliability standards in becoming a Medium or High Impact entity from an existing Low-Impact entity. Cost estimates from consultants range anywhere from \$100,000.00 for consultant fees only, to \$1 million or more depending on computer hardware, facility hardening, and security software. This is especially burdensome for smaller entities, such as NCPA, who need more time, money, and approvals from its governing board to make sure we have the funds and resources to properly prepare for and meet the new CIP reliability requirements.

Likes	0
-------	---

Dislikes	0
----------	---

**Response****Laura Nelson - IDACORP - Idaho Power Company - 1**

<b>Answer</b>	No
---------------	----

<b>Document Name</b>	
----------------------	--

**Comment**

Efforts for TCAs associated with low impact assets and BES Cyber Systems is substantially more work than it was for the high and medium impact locations and systems. The workload is simply due to the sheer volume of locations and people that need to be included in the scope of the procedures. Idaho Power Company is working through the procedural efforts, but a 24-month implementation period seems more appropriate due to the work load of the low impact TCA process build out.

Likes	0
-------	---

Dislikes	0
----------	---

**Response****Larry Watt - Lakeland Electric - 1**

<b>Answer</b>	No
---------------	----

<b>Document Name</b>	
----------------------	--

**Comment**

Efforts for TCAs associated with low impact assets and BES Cyber Systems is substantially more work than it was for the high and medium impact locations and systems. The workload is simply due to the sheer volume of locations and people that need to be included in the scope of the procedures. Procedural efforts are in progress, but a 24-month implementation period seems more appropriate due to the work load of the low impact TCA process build out. Also for consideration, Attachment 2 Section 5 part 2 indicates that contracts must be modified. Contract may take over 6 months to modify. Consider changing the implementation to span a minimum of 12 months.

Likes 0

Dislikes 0

**Response**

**Jodirah Green - ACES Power Marketing - 6, Group Name ACES Standard Collaborations**

**Answer**

No

**Document Name**

**Comment**

This change causes an RE to review, change, update, and approve their CIP-003 documentation. Depending on when the standard is approved, this may not fall within the RE's 15 month programmatic review of CIP-003. Consequently, depending on the how the RE's program is designed, programmatic reviews are performed, and changes are implemented, this could have a significant resource impact. The number Low Impact BES CS are much greater than M and H making this change much broader and a greater level of effort than we believe the SDT anticipates.

Likes 0

Dislikes 0

**Response**

**Stephanie Burns - Stephanie Burns On Behalf of: Michael Moltane, International Transmission Company Holdings Corporation, 1; - Stephanie Burns**

**Answer**

No

**Document Name**

**Comment**

Do not believe 12 months is a good precedent.

Likes 0

Dislikes 0

**Response**

**Eli Rivera - Central Electric Cooperative, Inc. (Redmond, Oregon) - 1 - Texas RE**

**Answer**

No

**Document Name**

**Comment**

CenterPoint Energy Houston Electric, LLC (“CenterPoint Energy”) recommends the effective date for CIP-003-8 to be 12 calendar months after FERC approval to allow entities time to coordinate with third-parties that connect their Transient Cyber Assets to low impact BES Cyber Systems.

Likes 0

Dislikes 0

**Response**

**Aaron Cavanaugh - Bonneville Power Administration - 1,3,5,6 - WECC**

**Answer**

Yes

**Document Name**

**Comment**

None

Likes 0

Dislikes 0

**Response**

**Anthony Jablonski - ReliabilityFirst - 10**

**Answer**

Yes

**Document Name**

**Comment**

ReliabilityFirst agrees with the proposed modification.

Likes 0

Dislikes 0

**Response**

**Chris Wagner - Santee Cooper - 1, Group Name Santee Cooper**

**Answer**

Yes

**Document Name**

**Comment**

Likes 0

Dislikes 0

**Response**

**Devin Shines - PPL - Louisville Gas and Electric Co. - 1,3,5,6 - SERC,RF, Group Name PPL NERC Registered Affiliates**

**Answer** Yes

**Document Name**

**Comment**

Likes 0

Dislikes 0

**Response**

**Julie Severino - FirstEnergy - FirstEnergy Corporation - 1, Group Name FirstEnergy**

**Answer** Yes

**Document Name**

**Comment**

Likes 0

Dislikes 0

**Response**

**Leanna Lamatrice - AEP - 3**

**Answer** Yes

**Document Name**

**Comment**

Likes 0

Dislikes 0

**Response**

**Dana Klem - MRO - 1,2,3,4,5,6 - MRO, Group Name MRO NSRF**

**Answer** Yes

<b>Document Name</b>	
<b>Comment</b>	
Likes 0	
Dislikes 0	
<b>Response</b>	
<b>Jeanne Kurzynowski - CMS Energy - Consumers Energy Company - 1,3,4,5 - RF</b>	
<b>Answer</b>	Yes
<b>Document Name</b>	
<b>Comment</b>	
Likes 0	
Dislikes 0	
<b>Response</b>	
<b>James Anderson - CMS Energy - Consumers Energy Company - 1</b>	
<b>Answer</b>	Yes
<b>Document Name</b>	
<b>Comment</b>	
Likes 0	
Dislikes 0	
<b>Response</b>	
<b>Eric Ruskamp - Lincoln Electric System - 6</b>	
<b>Answer</b>	Yes
<b>Document Name</b>	
<b>Comment</b>	
Likes 0	
Dislikes 0	

**Response**

**Vivian Vo - APS - Arizona Public Service Co. - 3**

**Answer** Yes

**Document Name**

**Comment**

Likes 0

Dislikes 0

**Response**

**Kevin Salsbury - Berkshire Hathaway - NV Energy - 5**

**Answer** Yes

**Document Name**

**Comment**

Likes 0

Dislikes 0

**Response**

**Tyson Archie - Platte River Power Authority - 5**

**Answer** Yes

**Document Name**

**Comment**

Likes 0

Dislikes 0

**Response**

**Russell Martin II - Salt River Project - 1,3,5,6 - WECC**

**Answer** Yes

**Document Name**

**Comment**

Likes 0

Dislikes 0

**Response****Andy Fuhrman - Andy Fuhrman On Behalf of: Theresa Allard, Minnkota Power Cooperative Inc., 1; - Andy Fuhrman****Answer**

Yes

**Document Name****Comment**

Likes 0

Dislikes 0

**Response****Karl Blaszkowski - CMS Energy - Consumers Energy Company - 3****Answer**

Yes

**Document Name****Comment**

Likes 0

Dislikes 0

**Response****Heather Morgan - EDP Renewables North America LLC - 5****Answer**

Yes

**Document Name****Comment**

Likes 0

Dislikes 0

**Response**

**faranak sarbaz - Los Angeles Department of Water and Power - 1**

**Answer** Yes

**Document Name**

**Comment**

Likes 0

Dislikes 0

**Response**

**Nicholas Lauriat - Network and Security Technologies - 1**

**Answer** Yes

**Document Name**

**Comment**

Likes 0

Dislikes 0

**Response**

**Colby Bellville - Duke Energy - 1,3,5,6 - FRCC,SERC,RF, Group Name Duke Energy**

**Answer** Yes

**Document Name**

**Comment**

Likes 0

Dislikes 0

**Response**

**Anton Vu - Los Angeles Department of Water and Power - 6**

**Answer** Yes

**Document Name**

**Comment**



Likes 0

Dislikes 0

**Response**

**Ruida Shu - Northeast Power Coordinating Council - 1,2,3,4,5,6,7,8,9,10 - NPCC, Group Name RSC no Dominion and HQ**

**Answer**

Yes

**Document Name**

**Comment**

Likes 0

Dislikes 0

**Response**

**Douglas Johnson - American Transmission Company, LLC - 1**

**Answer**

Yes

**Document Name**

**Comment**

Likes 0

Dislikes 0

**Response**

**Sandra Shaffer - Berkshire Hathaway - PacifiCorp - 6**

**Answer**

Yes

**Document Name**

**Comment**

Likes 0

Dislikes 0

**Response**

**Maryanne Darling-Reich - Black Hills Corporation - 1,3,5,6 - WECC**

**Answer** Yes

**Document Name**

**Comment**

Likes 0

Dislikes 0

**Response**

**Leonard Kula - Independent Electricity System Operator - 2**

**Answer** Yes

**Document Name**

**Comment**

Likes 0

Dislikes 0

**Response**

**Rachel Coyne - Texas Reliability Entity, Inc. - 10**

**Answer** Yes

**Document Name**

**Comment**

Likes 0

Dislikes 0

**Response**

**David Jendras - Ameren - Ameren Services - 3**

**Answer** Yes

**Document Name**

**Comment**

Likes 0

Dislikes 0

**Response**

**Andrey Komissarov - Andrey Komissarov On Behalf of: Daniel Frank, Sempra - San Diego Gas and Electric, 3, 5, 1; - Andrey Komissarov**

**Answer** Yes

**Document Name**

**Comment**

Likes 0

Dislikes 0

**Response**

**William Sanders - Lower Colorado River Authority - 1**

**Answer** Yes

**Document Name**

**Comment**

Likes 0

Dislikes 0

**Response**

**Douglas Webb - Douglas Webb On Behalf of: Allen Klassen, Westar Energy, 6, 3, 1, 5; Bryan Taggart, Westar Energy, 6, 3, 1, 5; Derek Brown, Westar Energy, 6, 3, 1, 5; Grant Wilkerson, Westar Energy, 6, 3, 1, 5; Harold Wyble, Great Plains Energy - Kansas City Power and Light Co., 5, 1, 3, 6; James McBee, Great Plains Energy - Kansas City Power and Light Co., 5, 1, 3, 6; Jennifer Flandermeyer, Great Plains Energy - Kansas City Power and Light Co., 5, 1, 3, 6; John Carlson, Great Plains Energy - Kansas City Power and Light Co., 5, 1, 3, 6; - Douglas Webb**

**Answer** Yes

**Document Name**

**Comment**

Likes 0

Dislikes 0

**Response**

**Amber Orr - Public Utility District No. 1 of Pend Oreille County - 3**

Answer Yes

Document Name

Comment

Likes 0

Dislikes 0

Response

**Pamela Hunter - Southern Company - Southern Company Services, Inc. - 1,3,5,6 - SERC, Group Name Southern Company**

Answer Yes

Document Name

Comment

Likes 0

Dislikes 0

Response

**Ryan Walter - Tri-State G and T Association, Inc. - 1,3,5 - MRO,WECC**

Answer Yes

Document Name

Comment

Likes 0

Dislikes 0

Response

**Constantin Chitescu - Ontario Power Generation Inc. - 5**

Answer Yes

Document Name

Comment

Likes 0

Dislikes 0

**Response**

**Chris Scanlon - Exelon - 1**

**Answer**

Yes

**Document Name**

**Comment**

Likes 0

Dislikes 0

**Response**

**Todd Bennett - Associated Electric Cooperative, Inc. - 3, Group Name AECI**

**Answer**

**Document Name**

**Comment**

AECI supports the comments provided by NRECA.

Likes 0

Dislikes 0

**Response**

4. The SDT believes proposed modifications in CIP-003-8 provide entities with flexibility to meet the reliability objectives in a cost effective manner. Do you agree? If you do not agree, or if you agree but have suggestions for improvement to enable more cost effective approaches, please provide your recommendation and, if appropriate, technical or procedural justification.

Jodirah Green - ACES Power Marketing - 6, Group Name ACES Standard Collaborations

Answer No

Document Name

Comment

By changing the Implementation Plan to be effective based on the RE's 15 month review of CIP-003 or 15 calendar months, instead of the planned dates, it allows the RE to plan for changes to it's program during a normal review period.

We thank the SDT for allowing us to provide comments on these standards and providing clarity.

Likes 0

Dislikes 0

Response

Karl Blaszkowski - CMS Energy - Consumers Energy Company - 3

Answer No

Document Name

Comment

NO, WE DO NOT ARGEE, as the language of the "Planned Changes" treats High, Medium and Low Impact BES Cyber Systems/Assets all the same. Specifically, when it comes to Low Impact System/Assets, the changes mandate less flexibility and would require immediate, "upon commissioning" compliance and rather than being documented and discovered during the once every 15 calendar months assessment, necessitate real-time tracking of all modification projects that might add to or change Low Impact BES Cyber Systems/Assets.

Additionally:

- Much of the language dates back to the Implementation Plan of CIP-002 rev 2 and the document, **Implementation Plan for Newly Identified Critical Cyber Assets** when the focus was on much more critical and essential cyber assets that could potentially, significantly impact the reliability of the BES. Applying these same implementation/new milestones (and thus immediately "upon commissioning") and requirements to Low Impact BES Cyber Systems/Assets in not appropriate to the risk.
- To put things in perspective, Low Impact BES Cyber Systems/Assets typically would have previously been considered "non-critical" cyber assets under the earlier CIP versions/requirements and thus required zero protections, ever. Although, this may have resulted previously in some gap in protection, it is with this background that newly identified Low Impact BES Cyber Systems/Assets needs to be viewed.
- As such, a compliance implementation milestone table needs to be again utilized for not only Unplanned Changes, but Planned Changes as well.

- Additionally, keeping in line with the once every 15 calendar months assessment of cyber systems/assets, Planned additions of Low Impact BES Cyber Systems/Assets should not require individual real-time tracking (that would be necessitated with compliance upon commissioning) and instead should be discovered during the once every 15 calendar months assessment and then compliant some time thereafter, following the assessment. ...12 months seems a reasonable duration for this.
- Further, in contrast and to put things in better perspective, allowing 12 months for a High-Impact BES Cyber System/Asset (Or 24 months if a new asset type) for an Unplanned Change and yet requiring a Low Impact BES Cyber System/Asset as part of a “planned” modification to be compliant upon commissioning makes little sense, especially in a risk-based environment.
- Planned additions of new (or recently re-categorized) Low Impact systems/assets should have an implementation table commensurate with their low-to-minimal-to-possibly virtually non-existent impact.

Likes 0

Dislikes 0

**Response**

**Larry Watt - Lakeland Electric - 1**

**Answer**

No

**Document Name**

**Comment**

**Section 5.1 Planned and Unplanned Changes specifies 24 calendar months from the date of notification or detection of the Unplanned Change to become compliant with the new rating.**

**Consider first in the case of a Planner (RC, PC or TP) designating a whole generating station as necessary to avoid Adverse Reliability Impact (2.3) or critical to IROLs (2.6) Nothing about the BES Cyber Systems at that generating station has changed. Nothing can be corrected because the change is not based on megawatts or time. Instead, all the BES Cyber Systems must be made to conform to 8 additional standards. Some of these existing Low Impact BES Cyber Systems may have to be replaced because they are unsupported by patches and anti-malware.**

**24 Months is not enough time to take a Low Impact Facility and bring it into compliance as a Medium, especially for a generation facility. Budgets, new BES System design, equipment delivery, installation of equipment and patching, writing procedures, policy and processes, creating evidence and documentation are required to go from a Low Impact to a Medium Impact System and remain in compliance. Financially, the impact of this change will cost anywhere from hundreds of thousands to millions at a generating station of any size. This needs to be a minimum of 48 Months to be completed cost effectively.**

Likes 0

Dislikes 0

**Response**

**Tyson Archie - Platte River Power Authority - 5**

**Answer**

No

**Document Name**

**Comment**

Section 5.1 Planned and Unplanned Changes specifies 24 calendar months from the date of notification or detection of the Unplanned Change to become compliant with the new rating.

Consider first in the case of a Planner (RC, PC or TP) designating a whole generating station as necessary to avoid Adverse Reliability Impact (2.3) or critical to IROLs (2.6) Nothing about the BES Cyber Systems at that generating station has changed. Nothing can be corrected because the change is not based on megawatts or time. Instead, all the BES Cyber Systems must be made to conform to 8 additional standards. Some of these existing Low Impact BES Cyber Systems may have to be replaced because they are unsupported by patches and anti-malware.

24 Months is not enough time to take a Low Impact Facility and bring it into compliance as a Medium, especially for a generation facility. Budgets, new BES System design, equipment delivery, installation of equipment and patching, writing procedures, policy and processes, creating evidence and documentation are required to go from a Low Impact to a Medium Impact System and remain in compliance. Financially, the impact of this change will cost anywhere from hundreds of thousands to millions at a generating station of any size. This needs to be a minimum of 48 Months to be completed cost effectively.

Likes	0
-------	---

Dislikes	0
----------	---

**Response**

**Dennis Sismaet - Northern California Power Agency - 6**

Answer	No
--------	----

Document Name	
---------------	--

**Comment**

There is no reason to change the existing two year time period in preparing to meet the new Medium or High impact CIP reliability requirements. The new requirement to start the clock running when a contract with a customer is signed to provide control center operation services to manage their generation facilities doesn't make sense if the net real power from the additional 100 MW nameplate capacity only results in 50 MW of net real power during the following summer months. It is possible that all the work, time, and money spent to go from Low to Medium impact based on a signed contract would be wasted if the net real power never reaches the 1500 MW threshold.

It would be better to keep the existing two year transition period which starts when the net real power reaches the 1500 MW threshold, regardless, when the control center operation service contract gets signed.

Likes	0
-------	---

Dislikes	0
----------	---

**Response**

**Richard Jackson - U.S. Bureau of Reclamation - 1**

Answer	No
--------	----

Document Name	
---------------	--

**Comment**



Prior to proposing additional modifications, Reclamation recommends each SDT take additional time to effectively define the scope of each Standard Authorization Request to minimize the costs associated with the planning and adjustments required to achieve compliance with frequently changing requirements. This will provide entities with economical relief by allowing technical compliance with current standards.

Likes 0

Dislikes 0

## Response

### James Anderson - CMS Energy - Consumers Energy Company - 1

Answer

No

Document Name

Comment

NO, WE DO NOT ARGEE, as the language of the "Planned Changes" treats High, Medium and Low Impact BES Cyber Systems/Assets all the same. Specifically, when it comes to Low Impact System/Assets, the changes mandate less flexibility and would require immediate, "upon commissioning" compliance and rather than being documented and discovered during the once every 15 calendar months assessment, necessitate real-time tracking of all modification projects that might add to or change Low Impact BES Cyber Systems/Assets.

Additionally:

- Much of the language dates back to the Implementation Plan of CIP-002 rev 2 and the document, **Implementation Plan for Newly Identified Critical Cyber Assets** when the focus was on much more critical and essential cyber assets that could potentially, significantly impact the reliability of the BES. Applying these same implementation/new milestones (and thus immediately "upon commissioning") and requirements to Low Impact BES Cyber Systems/Assets in not appropriate to the risk.
- To put things in perspective, Low Impact BES Cyber Systems/Assets typically would have previously been considered "non-critical" cyber assets under the earlier CIP versions/requirements and thus required zero protections, ever. Although, this may have resulted previously in some gap in protection, it is with this background that newly identified Low Impact BES Cyber Systems/Assets needs to be viewed.
- As such, a compliance implementation milestone table needs to be again utilized for not only Unplanned Changes, but Planned Changes as well.
- Additionally, keeping in line with the once every 15 calendar months assessment of cyber systems/assets, Planned additions of Low Impact BES Cyber Systems/Assets should not require individual real-time tracking (that would be necessitated with compliance upon commissioning) and instead should be discovered during the once every 15 calendar months assessment and then compliant some time thereafter, following the assessment. ...12 months seems a reasonable duration for this.
- Further, in contrast and to put things in better perspective, allowing 12 months for a High-Impact BES Cyber System/Asset (Or 24 months if a new asset type) for an Unplanned Change and yet requiring a Low Impact BES Cyber System/Asset as part of a "planned" modification to be compliant upon commissioning makes little sense, especially in a risk-based environment.
- Planned additions of new (or recently re-categorized) Low Impact systems/assets should have an implementation table commensurate with their low-to-minimal-to-possibly virtually non-existent impact.

Likes 0

Dislikes 0

**Response**

**Jeanne Kurzynowski - CMS Energy - Consumers Energy Company - 1,3,4,5 - RF**

**Answer** No

**Document Name**

**Comment**

NO, WE DO NOT ARGEE, as the language of the “Planned Changes” treats High, Medium and Low Impact BES Cyber Systems/Assets all the same. Specifically, when it comes to Low Impact System/Assets, the changes mandate less flexibility and would require immediate, “upon commissioning” compliance and rather than being documented and discovered during the once every 15 calendar months assessment, necessitate real-time tracking of all modification projects that might add to or change Low Impact BES Cyber Systems/Assets.

Additionally:

- Much of the language dates back to the Implementation Plan of CIP-002 rev 2 and the document, **Implementation Plan for Newly Identified Critical Cyber Assets** when the focus was on much more critical and essential cyber assets that could potentially, significantly impact the reliability of the BES. Applying these same implementation/new milestones (and thus immediately “upon commissioning”) and requirements to Low Impact BES Cyber Systems/Assets in not appropriate to the risk.
- To put things in perspective, Low Impact BES Cyber Systems/Assets typically would have previously been considered “non-critical” cyber assets under the earlier CIP versions/requirements and thus required zero protections, ever. Although, this may have resulted previously in some gap in protection, it is with this background that newly identified Low Impact BES Cyber Systems/Assets needs to be viewed.
- As such, a compliance implementation milestone table needs to be again utilized for not only Unplanned Changes, but Planned Changes as well.
- Additionally, keeping in line with the once every 15 calendar months assessment of cyber systems/assets, Planned additions of Low Impact BES Cyber Systems/Assets should not require individual real-time tracking (that would be necessitated with compliance upon commissioning) and instead should be discovered during the once every 15 calendar months assessment and then compliant some time thereafter, following the assessment. ...12 months seems a reasonable duration for this.
- Further, in contrast and to put things in better perspective, allowing 12 months for a High-Impact BES Cyber System/Asset (Or 24 months if a new asset type) for an Unplanned Change and yet requiring a Low Impact BES Cyber System/Asset as part of a “planned” modification to be compliant upon commissioning makes little sense, especially in a risk-based environment.
- Planned additions of new (or recently re-categorized) Low Impact systems/assets should have an implementation table commensurate with their low-to-minimal-to-possibly virtually non-existent impact.

Likes 0

Dislikes 0

**Response**

**Chris Wagner - Santee Cooper - 1, Group Name Santee Cooper**

**Answer** No

**Document Name**

**Comment**

**Section 5.1 Planned and Unplanned Changes specifies 24 calendar months from the date of notification or detection of the Unplanned Change to become compliant with the new rating.**

**Consider first in the case of a Planner (RC, PC or TP) designating a whole generating station as necessary to avoid Adverse Reliability Impact (2.3) or critical to IROLs (2.6) Nothing about the BES Cyber Systems at that generating station has changed. Nothing can be corrected because the change is not based on megawatts or time. Instead, all the BES Cyber Systems must be made to conform to 8 additional standards. Some of these existing Low Impact BES Cyber Systems may have to be replaced because they are unsupported by patches and anti-malware.**

**24 Months is not enough time to take a Low Impact Facility and bring it into compliance as a Medium, especially for a generation facility. Budgets, new BES System design, equipment delivery, installation of equipment and patching, writing procedures, policy and processes, creating evidence and documentation are required to go from a Low Impact to a Medium Impact System and remain in compliance. Financially, the impact of this change will cost anywhere from hundreds of thousands to millions at a generating station of any size. This needs to be a minimum of 48 Months to be completed cost effectively.**

Likes 0

Dislikes 0

**Response**

**Anthony Jablonski - ReliabilityFirst - 10**

**Answer**

Yes

**Document Name**

**Comment**

ReliabilityFirst agrees with the proposed modification.

Likes 0

Dislikes 0

**Response**

**Chris Scanlon - Exelon - 1**

**Answer**

Yes

**Document Name**

**Comment**

Likes 0

Dislikes 0

**Response**

**Constantin Chitescu - Ontario Power Generation Inc. - 5**

**Answer** Yes

**Document Name**

**Comment**

Likes 0

Dislikes 0

**Response**

**Ryan Walter - Tri-State G and T Association, Inc. - 1,3,5 - MRO,WECC**

**Answer** Yes

**Document Name**

**Comment**

Likes 0

Dislikes 0

**Response**

**Pamela Hunter - Southern Company - Southern Company Services, Inc. - 1,3,5,6 - SERC, Group Name Southern Company**

**Answer** Yes

**Document Name**

**Comment**

Likes 0

Dislikes 0

**Response**

**Amber Orr - Public Utility District No. 1 of Pend Oreille County - 3**

**Answer** Yes

**Document Name**

<b>Comment</b>	
Likes	0
Dislikes	0
<b>Response</b>	
<b>Douglas Webb - Douglas Webb On Behalf of: Allen Klassen, Westar Energy, 6, 3, 1, 5; Bryan Taggart, Westar Energy, 6, 3, 1, 5; Derek Brown, Westar Energy, 6, 3, 1, 5; Grant Wilkerson, Westar Energy, 6, 3, 1, 5; Harold Wyble, Great Plains Energy - Kansas City Power and Light Co., 5, 1, 3, 6; James McBee, Great Plains Energy - Kansas City Power and Light Co., 5, 1, 3, 6; Jennifer Flandermeyer, Great Plains Energy - Kansas City Power and Light Co., 5, 1, 3, 6; John Carlson, Great Plains Energy - Kansas City Power and Light Co., 5, 1, 3, 6; - Douglas Webb</b>	
Answer	Yes
Document Name	
<b>Comment</b>	
Likes	0
Dislikes	0
<b>Response</b>	
<b>William Sanders - Lower Colorado River Authority - 1</b>	
Answer	Yes
Document Name	
<b>Comment</b>	
Likes	0
Dislikes	0
<b>Response</b>	
<b>Andrey Komissarov - Andrey Komissarov On Behalf of: Daniel Frank, Sempra - San Diego Gas and Electric, 3, 5, 1; - Andrey Komissarov</b>	
Answer	Yes
Document Name	
<b>Comment</b>	
Likes	0

Dislikes 0

**Response**

**Stephanie Burns - Stephanie Burns On Behalf of: Michael Moltane, International Transmission Company Holdings Corporation, 1; - Stephanie Burns**

**Answer**

Yes

**Document Name**

**Comment**

Likes 0

Dislikes 0

**Response**

**David Jendras - Ameren - Ameren Services - 3**

**Answer**

Yes

**Document Name**

**Comment**

Likes 0

Dislikes 0

**Response**

**Rachel Coyne - Texas Reliability Entity, Inc. - 10**

**Answer**

Yes

**Document Name**

**Comment**

Likes 0

Dislikes 0

**Response**

**Leonard Kula - Independent Electricity System Operator - 2**

Answer	Yes
Document Name	
Comment	
Likes 0	
Dislikes 0	
Response	
<b>Maryanne Darling-Reich - Black Hills Corporation - 1,3,5,6 - WECC</b>	
Answer	Yes
Document Name	
Comment	
Likes 0	
Dislikes 0	
Response	
<b>Sandra Shaffer - Berkshire Hathaway - PacifiCorp - 6</b>	
Answer	Yes
Document Name	
Comment	
Likes 0	
Dislikes 0	
Response	
<b>Douglas Johnson - American Transmission Company, LLC - 1</b>	
Answer	Yes
Document Name	
Comment	
Likes 0	

Dislikes 0

**Response**

**Anton Vu - Los Angeles Department of Water and Power - 6**

**Answer**

Yes

**Document Name**

**Comment**

Likes 0

Dislikes 0

**Response**

**Colby Bellville - Duke Energy - 1,3,5,6 - FRCC,SERC,RF, Group Name Duke Energy**

**Answer**

Yes

**Document Name**

**Comment**

Likes 0

Dislikes 0

**Response**

**Nicholas Lauriat - Network and Security Technologies - 1**

**Answer**

Yes

**Document Name**

**Comment**

Likes 0

Dislikes 0

**Response**

**faranak sarbaz - Los Angeles Department of Water and Power - 1**

**Answer**

Yes



<b>Document Name</b>	
<b>Comment</b>	
Likes 0	
Dislikes 0	
<b>Response</b>	
<b>Heather Morgan - EDP Renewables North America LLC - 5</b>	
<b>Answer</b>	Yes
<b>Document Name</b>	
<b>Comment</b>	
Likes 0	
Dislikes 0	
<b>Response</b>	
<b>Andy Fuhrman - Andy Fuhrman On Behalf of: Theresa Allard, Minnkota Power Cooperative Inc., 1; - Andy Fuhrman</b>	
<b>Answer</b>	Yes
<b>Document Name</b>	
<b>Comment</b>	
Likes 0	
Dislikes 0	
<b>Response</b>	
<b>Russell Martin II - Salt River Project - 1,3,5,6 - WECC</b>	
<b>Answer</b>	Yes
<b>Document Name</b>	
<b>Comment</b>	
Likes 0	
Dislikes 0	

**Response**

**Kevin Salsbury - Berkshire Hathaway - NV Energy - 5**

**Answer** Yes

**Document Name**

**Comment**

Likes 0

Dislikes 0

**Response**

**Vivian Vo - APS - Arizona Public Service Co. - 3**

**Answer** Yes

**Document Name**

**Comment**

Likes 0

Dislikes 0

**Response**

**Eric Ruskamp - Lincoln Electric System - 6**

**Answer** Yes

**Document Name**

**Comment**

Likes 0

Dislikes 0

**Response**

**Laura Nelson - IDACORP - Idaho Power Company - 1**

**Answer** Yes

**Document Name**

**Comment**

Likes 0

Dislikes 0

**Response**

**Dana Klem - MRO - 1,2,3,4,5,6 - MRO, Group Name MRO NSRF**

**Answer**

Yes

**Document Name**

**Comment**

Likes 0

Dislikes 0

**Response**

**Leanna Lamatrice - AEP - 3**

**Answer**

Yes

**Document Name**

**Comment**

Likes 0

Dislikes 0

**Response**

**Julie Severino - FirstEnergy - FirstEnergy Corporation - 1, Group Name FirstEnergy**

**Answer**

Yes

**Document Name**

**Comment**

Likes 0

Dislikes 0

**Response**

**Devin Shines - PPL - Louisville Gas and Electric Co. - 1,3,5,6 - SERC,RF, Group Name PPL NERC Registered Affiliates**

**Answer** Yes

**Document Name**

**Comment**

Likes 0

Dislikes 0

**Response**

**Joe Tarantino - Joe Tarantino On Behalf of: Arthur Starkovich, Sacramento Municipal Utility District, 4, 1, 5, 6, 3; Beth Tincher, Sacramento Municipal Utility District, 4, 1, 5, 6, 3; Jamie Cutlip, Sacramento Municipal Utility District, 4, 1, 5, 6, 3; Kevin Smith, Balancing Authority of Northern California, 1; Nicole Looney, Sacramento Municipal Utility District, 4, 1, 5, 6, 3; Susan Oto, Sacramento Municipal Utility District, 4, 1, 5, 6, 3; - Joe Tarantino**

**Answer** Yes

**Document Name**

**Comment**

Likes 0

Dislikes 0

**Response**

**Eli Rivera - Central Electric Cooperative, Inc. (Redmond, Oregon) - 1 - Texas RE**

**Answer**

**Document Name**

**Comment**

No response.

Likes 0

Dislikes 0

**Response**

**Todd Bennett - Associated Electric Cooperative, Inc. - 3, Group Name AECI**

<b>Answer</b>	
<b>Document Name</b>	
<b>Comment</b>	
AECI supports the comments provided by NRECA.	
Likes 0	
Dislikes 0	
<b>Response</b>	
<b>Jonathan Robbins - Seminole Electric Cooperative, Inc. - 1,3,4,5,6 - FRCC</b>	
<b>Answer</b>	
<b>Document Name</b>	
<b>Comment</b>	
No comments regarding modifications.	
Likes 0	
Dislikes 0	
<b>Response</b>	

## Comment Report

**Project Name:** 2016-02 Modifications to CIP Standards | CIP-003-8  
**Comment Period Start Date:** 8/23/2018  
**Comment Period End Date:** 10/9/2018  
**Associated Ballots:** 2016-02 Modifications to CIP Standards CIP-003-8 Draft 1 IN 1 ST

There were 50 sets of responses, including comments from approximately 131 different people from approximately 92 companies representing 10 of the Industry Segments as shown in the table on the following pages.

## Questions

- 1. Requirement R2, Attachment 1, Section 5.2:** In response to the directive in FERC Order 843, the SDT modified Attachment 1, Section 5.2 adding subsection 5.2.2 to state: “For any method used pursuant to 5.2.1, Responsible Entities shall determine whether any additional mitigation actions are necessary and implement such actions prior to connecting the Transient Cyber Asset.” Do you agree with this revision? If not, please provide the basis for your disagreement and an alternate proposal.
- 2. Guidelines and Technical Basis:** The SDT made changes to the Guidelines and Technical Basis section of the Standard to conform with the modifications it made to Attachment 1, Section 5.2. Do you agree with these changes to the Guidelines and Technical Basis? If not, please provide the basis for your disagreement and an alternate proposal. (The CIP SDT is aware that another initiative is underway to convert all GTB sections to Technical Rationale documents. This effort is outside the scope of this SDT.)
- 3. Implementation Plan:** The SDT established the Implementation Plan to make the standard effective the later of (1) January 1, 2020, or (2) the first day of the first calendar quarter that is six (6) calendar months after the effective date of the applicable governmental authority’s order approving the standard, or as otherwise provided for by the applicable governmental authority. Do you agree with this proposal? If you think an alternate effective date is needed, please provide a detailed explanation of actions and time needed.
- 4. The SDT believes proposed modifications in CIP-003-8 provide entities with flexibility to meet the reliability objectives in a cost effective manner. Do you agree? If you do not agree, or if you agree but have suggestions for improvement to enable more cost effective approaches, please provide your recommendation and, if appropriate, technical or procedural justification.**

Organization Name	Name	Segment(s)	Region	Group Name	Group Member Name	Group Member Organization	Group Member Segment(s)	Group Member Region
Santee Cooper	Chris Wagner	1		Santee Cooper	Rene' Free	Santee Cooper	1,3,5,6	SERC
					Rodger Blakely	Santee Cooper	1,3,5,6	SERC
					Troy Lee	Santee Cooper	1,3,5,6	SERC
					Jennifer Richards	Santee Cooper	1,3,5,6	SERC
					Chris Jimenez	Santee Cooper	1,3,5,6	SERC
Duke Energy	Colby Bellville	1,3,5,6	FRCC,RF,SERC	Duke Energy	Doug Hils	Duke Energy	1	RF
					Lee Schuster	Duke Energy	3	FRCC
					Dale Goodwine	Duke Energy	5	SERC
					Greg Cecil	Duke Energy	6	RF
MRO	Dana Klem	1,2,3,4,5,6	MRO	MRO NSRF	Joseph DePoorter	Madison Gas & Electric	3,4,5,6	MRO
					Larry Heckert	Alliant Energy	4	MRO
					Amy Casucelli	Xcel Energy	1,3,5,6	MRO
					Michael Brytowski	Great River Energy	1,3,5,6	MRO
					Jodi Jensen	Western Area Power Administration	1,6	MRO
					Kayleigh Wilkerson	Lincoln Electric System	1,3,5,6	MRO
					Mahmood Safi	Omaha Public Power District	1,3,5,6	MRO
					Brad Parret	Minnesota Power	1,5	MRO
					Terry Harbour	MidAmerican Energy Company	1,3	MRO
					Tom Breene	Wisconsin Public Service Corporation	3,5,6	MRO



					Jeremy Voll	Basin Electric Power Cooperative	1	MRO
					Kevin Lyons	Central Iowa Power Cooperative	1	MRO
					Mike Morrow	Midcontinent ISO	2	MRO
PPL - Louisville Gas and Electric Co.	Devin Shines	1,3,5,6	RF,SERC	PPL NERC Registered Affiliates	Brenda Truhe	PPL Electric Utilities Corporation	1	RF
					Charles Freibert	PPL - Louisville Gas and Electric Co.	3	SERC
					JULIE HOSTRANDER	PPL - Louisville Gas and Electric Co.	5	SERC
					Linn Oelker	PPL - Louisville Gas and Electric Co.	6	SERC
ACES Power Marketing	Jodirah Green	6	NA - Not Applicable	ACES Standard Collaborations	Shari Heino	Brazos Electric Power Cooperative, Inc.	5	Texas RE
					John Shaver	Arizona Electric Power Cooperative, Inc.	1	WECC
					Joseph Smith	Prairie Power	3	SERC
					Susan Sosbe	Wabash Valley Power Association	3	RF
					Bob Solomon	Hoosier Energy Rural Electric Cooperative, Inc.	1	SERC
					Tara Lightner	Sunflower Electric Power Corporation	1	MRO
FirstEnergy - FirstEnergy Corporation	Julie Severino	1		FirstEnergy	Aubrey Short	FirstEnergy - FirstEnergy Corporation	4	RF

					Aaron Ghodooshim	FirstEnergy - FirstEnergy Corporation	3	RF
					Robert Loy	FirstEnergy - FirstEnergy Solutions	5	RF
					Ann Ivanc	FirstEnergy - FirstEnergy Solutions	6	RF
Southern Company - Southern Company Services, Inc.	Pamela Hunter	1,3,5,6	SERC	Southern Company	Katherine Prewitt	Southern Company Services, Inc.	1	SERC
					Joel Dembowski	Southern Company - Alabama Power Company	3	SERC
					William D. Shultz	Southern Company Generation	5	SERC
					Jennifer G. Sykes	Southern Company Generation and Energy Marketing	6	SERC
Northeast Power Coordinating Council	Ruida Shu	1,2,3,4,5,6,7,8,9,10	NPCC	RSC no Dominion and HQ	Guy V. Zito	Northeast Power Coordinating Council	10	NPCC
					Randy MacDonald	New Brunswick Power	2	NPCC
					Wayne Sipperly	New York Power Authority	4	NPCC
					Glen Smith	Entergy Services	4	NPCC
					Brian Robinson	Utility Services	5	NPCC
					Alan Adamson	New York State Reliability Council	7	NPCC
					Edward Bedder	Orange & Rockland Utilities	1	NPCC

David Burke	Orange & Rockland Utilities	3	NPCC
Michele Tondalo	UI	1	NPCC
Laura Mcleod	NB Power	1	NPCC
David Ramkalawan	Ontario Power Generation Inc.	5	NPCC
Helen Lainis	IESO	2	NPCC
Michael Schiavone	National Grid	1	NPCC
Michael Jones	National Grid	3	NPCC
Michael Forte	Con Ed - Consolidated Edison	1	NPCC
Peter Yost	Con Ed - Consolidated Edison Co. of New York	3	NPCC
Sean Cavote	PSEG	4	NPCC
Kathleen Goodman	ISO-NE	2	NPCC
Quintin Lee	Eversource Energy	1	NPCC
Dermot Smyth	Con Ed - Consolidated Edison Co. of New York	1,5	NPCC
Salvatore Spagnolo	New York Power Authority	1	NPCC
Shivaz Chopra	New York Power Authority	6	NPCC
David Kiguel	Independent	NA - Not Applicable	NPCC
Silvia Mitchell	NextEra Energy - Florida Power and Light Co.	6	NPCC
Paul Malozewski	Hydro One Networks, Inc.	3	NPCC
Gregory Campoli	New York Independent	2	NPCC

						System Operator		
Associated Electric Cooperative, Inc.	Todd Bennett	3		AECI	Michael Bax	Central Electric Power Cooperative (Missouri)	1	SERC
					Adam Weber	Central Electric Power Cooperative (Missouri)	3	SERC
					Stephen Pogue	M and A Electric Power Cooperative	3	SERC
					William Price	M and A Electric Power Cooperative	1	SERC
					Jeff Neas	Sho-Me Power Electric Cooperative	3	SERC
					Peter Dawson	Sho-Me Power Electric Cooperative	1	SERC
					Mark Ramsey	N.W. Electric Power Cooperative, Inc.	1	NPCC
					John Stickley	NW Electric Power Cooperative, Inc.	3	SERC
					Ted Hilmes	KAMO Electric Cooperative	3	SERC
					Walter Kenyon	KAMO Electric Cooperative	1	SERC
					Kevin White	Northeast Missouri Electric Power Cooperative	1	SERC
					Skyler Wiegmann	Northeast Missouri Electric Power Cooperative	3	SERC
					Ryan Ziegler	Associated Electric Cooperative, Inc.	1	SERC

					Brian Ackermann	Associated Electric Cooperative, Inc.	6	SERC
					Brad Haralson	Associated Electric Cooperative, Inc.	5	SERC

**1. Requirement R2, Attachment 1, Section 5.2: In response to the directive in FERC Order 843, the SDT modified Attachment 1, Section 5.2 adding subsection 5.2.2 to state: “For any method used pursuant to 5.2.1, Responsible Entities shall determine whether any additional mitigation actions are necessary and implement such actions prior to connecting the Transient Cyber Asset.” Do you agree with this revision? If not, please provide the basis for your disagreement and an alternate proposal.**

**Dana Klem - MRO - 1,2,3,4,5,6 - MRO, Group Name MRO NSRF**

**Answer** No

**Document Name**

**Comment**

The NSRF recommends the following change for clarity to the draft 5.2.2 (added text is bracketed) “For any method used pursuant to 5.2.1, Responsible Entities shall determine whether any additional mitigation actions are necessary and[, if any,] implement such actions prior to connecting the Transient Cyber Asset.”

Likes 0

Dislikes 0

**Response**

Thank you for your comment. The SDT agrees that the mitigation actions only need to be implemented if the Responsible Entity determines any are necessary. The SDT asserts that this understanding is clear with the drafted language and declines to make this change.

**Richard Jackson - U.S. Bureau of Reclamation - 1**

**Answer** No

**Document Name**

**Comment**

The proposed language is too vague, will not add value, and is not auditable. Reclamation recommends any changes pertaining to low impact TCA and RM should align with CIP-010 Attachment 1 and provide equal or less stringent controls for low impact BES Cyber Systems as for medium and high impact BES Cyber Systems.

Likes 0

Dislikes 0

**Response**

Thank you for your comment. The language inserted in section 5.2 of CIP-003-8 aligns with CIP-010 and was taken verbatim from CIP-010-2 Attachment 1, Section 2.3.

**Laura Nelson - IDACORP - Idaho Power Company - 1**

**Answer** No

**Document Name**

**Comment**

Idaho Power Company does not believe that this is an auditable approach by the way the standards are written. A Responsible Entity that believed any additional mitigation actions were necessary would implement those additional measures. Stating the requirements in this manner seems vague and lacks the auditability of a normal requirement. It would be more appropriate to have a Responsible Entity document the steps that were taken prior to allowing a third party to connect a TCA.

Likes 0

Dislikes 0

### Response

Thank you for your comment. The language inserted in section 5.2 of CIP-003-8 aligns with CIP-010 and was taken verbatim from CIP-010-2 Attachment 1, Section 2.3. This language was added to comply with the directive from FERC Order No. 843, paragraph 39 to include an explicit requirement that Responsible Entities implement controls to mitigate the risk of malicious code that could result from third-party transient electronic devices.

### Eric Ruskamp - Lincoln Electric System - 6

Answer

No

Document Name

### Comment

LES supports the NSRF comments:

The NSRF recommends the following change for clarity to the draft 5.2.2 (added text is bracketed) "For any method used pursuant to 5.2.1, Responsible Entities shall determine whether any additional mitigation actions are necessary and[, if any,] implement such actions prior to connecting the Transient Cyber Asset."

Likes 0

Dislikes 0

### Response

Thank you for your comment. The SDT agrees that the mitigation actions only need to be implemented if the Responsible Entity determines any are necessary. The SDT asserts that this understanding is clear with the drafted language and declines to make this change.

### Tyson Archie - Platte River Power Authority - 5

Answer

No

Document Name

### Comment

There appears to be a disconnect between the intent as noted in the Guidelines and Technical Basis and the requirement documented in CIP-003-8, Attachment 1, 5.2.2. The intent is that, "if there are deficiencies identified" then mitigation actions must be completed. The requirement does not contain the 'if then' syntax.

Consider revising 5.2.2 as follows:

If deficiencies are identified for any method used pursuant to 5.2.1, then the Responsible Entity shall implement mitigation actions to address the deficiencies prior to connecting the Transient Cyber Asset.

Consider revising CIP-003-8, Attachment 2, Section 5 (2) as follows:

Examples of evidence for Attachment 1, Section 5.2.2 may include, but are not limited to, documentation from change management systems, electronic mail, or contracts that identify mitigation actions that were implemented prior to connecting the Transient Cyber Asset managed by a party and that were implemented to address deficiencies of any method used pursuant to 5.2.1

Likes 0

Dislikes 0

### Response

Thank you for your comment. The SDT asserts that the intent noted in the Guidelines and Technical Basis is consistent with the language added to section 5.2.2 of CIP-003-8 Attachment 1. The Responsible Entity is responsible for determining whether additional mitigation actions are necessary.

**Larry Watt - Lakeland Electric - 1**

**Answer**

No

**Document Name**

**Comment**

The proposed language is too vague, will not add value, and is not auditable. Reclamation recommends any changes pertaining to low impact TCA and RM should align with CIP-010 Attachment 1 and provide equal controls for low impact BES Cyber Systems as for medium and high impact BES Cyber Systems.

Likes 0

Dislikes 0

### Response

Thank you for your comment. The language inserted in section 5.2 of CIP-003-8 aligns with CIP-010 and was taken verbatim from CIP-010-2 Attachment 1, Section 2.3.

**Andy Fuhrman - Andy Fuhrman On Behalf of: Theresa Allard, Minnkota Power Cooperative Inc., 1; - Andy Fuhrman**

**Answer**

No

**Document Name**

**Comment**

Please refer to comments from the MRO NERC Standards Review Forum (NSRF).

Likes 0

Dislikes 0

### Response

Thank you for your comments. Please see the SDT response to the MRO NSRF comments.

**Stephanie Burns - Stephanie Burns On Behalf of: Michael Moltane, International Transmission Company Holdings Corporation, 1; - Stephanie Burns**

**Answer**

No

**Document Name**



**Comment**

ITC is in agreement with statements made by the NSRF:

The NSRF recommends the following change for clarity to the draft 5.2.2 (added text is bracketed) “For any method used pursuant to 5.2.1, Responsible Entities shall determine whether any additional mitigation actions are necessary and[, if any,] implement such actions prior to connecting the Transient Cyber Asset.”

Likes 0

Dislikes 0

**Response**

Thank you for your comment. The SDT agrees that the mitigation actions only need to be implemented if the Responsible Entity determines any are necessary. The SDT asserts that this understanding is clear with the drafted language and declines to make this change.

**Andrey Komissarov - Andrey Komissarov On Behalf of: Daniel Frank, Sempra - San Diego Gas and Electric, 3, 5, 1; - Andrey Komissarov**

**Answer**

No

**Document Name**

**Comment**

The final bullet of 5.2.1 “Other method(s) to mitigate the introduction of malicious code” addresses the issue. If the entity deems it necessary to use another method, they already have this provision in place. Section 5.2.2 only confuses the matter.

Likes 0

Dislikes 0

**Response**

Thank you for your comment. The language inserted in section 5.2 of CIP-003-8 aligns with CIP-010 and was taken from CIP-010-2 Attachment 1, Section 2.3. This language was added to comply with the directive from FERC Order No. 843, paragraph 39 to include an explicit requirement that Responsible Entities implement controls to mitigate the risk of malicious code that could result from third-party transient electronic devices.

**Aaron Cavanaugh - Bonneville Power Administration - 1,3,5,6 - WECC**

**Answer**

Yes

**Document Name**

**Comment**

None

Likes 0

Dislikes 0

**Response**

**Anthony Jablonski - ReliabilityFirst - 10**

**Answer** Yes

**Document Name**

**Comment**

ReliabilityFirst agrees with the proposed modification.

Likes 0

Dislikes 0

**Response**

**Barry Lawson - National Rural Electric Cooperative Association - 4**

**Answer** Yes

**Document Name**

**Comment**

NRECA recommends the following change for clarity to the draft 5.2.2 (added text is bracketed) "For any method used pursuant to 5.2.1, Responsible Entities shall determine whether any additional mitigation actions are necessary and[, if any,] implement such actions prior to connecting the Transient Cyber Asset."

Likes 0

Dislikes 0

**Response**

Thank you for your comment. The SDT agrees that the mitigation actions only need to be implemented if the Responsible Entity determines any are necessary. The SDT asserts that this understanding is clear with the drafted language and declines to make this change.

**Lana Smith - San Miguel Electric Cooperative, Inc. - 5 - Texas RE**

**Answer** Yes

**Document Name**

**Comment**

SMEC agrees with NRECA Comment:

recommends the following change for clarity to the draft 5.2.2 (added text is bracketed) "For any method used pursuant to 5.2.1, Responsible Entities shall determine whether any additional mitigation actions are necessary and[, if any,] implement such actions prior to connecting the Transient Cyber Asset."

Likes 0

Dislikes 0

**Response**

Thank you for your comment. The SDT agrees that the mitigation actions only need to be implemented if the Responsible Entity determines any are necessary. The SDT asserts that this understanding is clear with the drafted language and declines to make this change.

**Andrea Barclay - Georgia System Operations Corporation - 4**

**Answer**

Yes

**Document Name**

**Comment**

Recommends the following change for clarity to the draft 5.2.2 (added text is bracketed) "For any method used pursuant to 5.2.1, Responsible Entities shall determine whether any additional mitigation actions are necessary and[, if any,] implement such actions prior to connecting the Transient Cyber Asset."

Likes 0

Dislikes 0

**Response**

Thank you for your comment. The SDT agrees that the mitigation actions only need to be implemented if the Responsible Entity determines any are necessary. The SDT asserts that this understanding is clear with the drafted language and declines to make this change.

**Joe Tarantino - Joe Tarantino On Behalf of: Arthur Starkovich, Sacramento Municipal Utility District, 4, 1, 5, 6, 3; Beth Tincher, Sacramento Municipal Utility District, 4, 1, 5, 6, 3; Jamie Cutlip, Sacramento Municipal Utility District, 4, 1, 5, 6, 3; Kevin Smith, Balancing Authority of Northern California, 1; Nicole Looney, Sacramento Municipal Utility District, 4, 1, 5, 6, 3; Susan Oto, Sacramento Municipal Utility District, 4, 1, 5, 6, 3; - Joe Tarantino**

**Answer**

Yes

**Document Name**

**Comment**

Likes 0

Dislikes 0

**Response**

**Chris Wagner - Santee Cooper - 1, Group Name Santee Cooper**

**Answer**

Yes

**Document Name**

**Comment**

Likes 0

Dislikes 0

**Response**

**Devin Shines - PPL - Louisville Gas and Electric Co. - 1,3,5,6 - SERC,RF, Group Name PPL NERC Registered Affiliates**

**Answer** Yes

**Document Name**

**Comment**

Likes 0

Dislikes 0

**Response**

**Julie Severino - FirstEnergy - FirstEnergy Corporation - 1, Group Name FirstEnergy**

**Answer** Yes

**Document Name**

**Comment**

Likes 0

Dislikes 0

**Response**

**Leanna Lamatrice - AEP - 3**

**Answer** Yes

**Document Name**

**Comment**

Likes 0

Dislikes 0

**Response**

**Jeanne Kurzynowski - CMS Energy - Consumers Energy Company - 1,3,4,5 - RF**

**Answer** Yes

<b>Document Name</b>	
<b>Comment</b>	
Likes 0	
Dislikes 0	
<b>Response</b>	
<b>James Anderson - CMS Energy - Consumers Energy Company - 1</b>	
<b>Answer</b>	Yes
<b>Document Name</b>	
<b>Comment</b>	
Likes 0	
Dislikes 0	
<b>Response</b>	
<b>Dennis Sismaet - Northern California Power Agency - 6</b>	
<b>Answer</b>	Yes
<b>Document Name</b>	
<b>Comment</b>	
Likes 0	
Dislikes 0	
<b>Response</b>	
<b>Vivian Vo - APS - Arizona Public Service Co. - 3</b>	
<b>Answer</b>	Yes
<b>Document Name</b>	
<b>Comment</b>	
Likes 0	
Dislikes 0	

**Response**

**Kevin Salsbury - Berkshire Hathaway - NV Energy - 5**

**Answer** Yes

**Document Name**

**Comment**

Likes 0

Dislikes 0

**Response**

**Russell Martin II - Salt River Project - 1,3,5,6 - WECC**

**Answer** Yes

**Document Name**

**Comment**

Likes 0

Dislikes 0

**Response**

**Karl Blaszkowski - CMS Energy - Consumers Energy Company - 3**

**Answer** Yes

**Document Name**

**Comment**

Likes 0

Dislikes 0

**Response**

**Heather Morgan - EDP Renewables North America LLC - 5**

**Answer** Yes

**Document Name**

**Comment**

Likes 0

Dislikes 0

**Response****faranak sarbaz - Los Angeles Department of Water and Power - 1****Answer**

Yes

**Document Name****Comment**

Likes 0

Dislikes 0

**Response****Nicholas Lauriat - Network and Security Technologies - 1****Answer**

Yes

**Document Name****Comment**

Likes 0

Dislikes 0

**Response****Colby Bellville - Duke Energy - 1,3,5,6 - FRCC,SERC,RF, Group Name Duke Energy****Answer**

Yes

**Document Name****Comment**

Likes 0

Dislikes 0

**Response**

**Anton Vu - Los Angeles Department of Water and Power - 6**

**Answer** Yes

**Document Name**

**Comment**

Likes 0

Dislikes 0

**Response**

**Ruida Shu - Northeast Power Coordinating Council - 1,2,3,4,5,6,7,8,9,10 - NPCC, Group Name RSC no Dominion and HQ**

**Answer** Yes

**Document Name**

**Comment**

Likes 0

Dislikes 0

**Response**

**Douglas Johnson - American Transmission Company, LLC - 1**

**Answer** Yes

**Document Name**

**Comment**

Likes 0

Dislikes 0

**Response**

**Sandra Shaffer - Berkshire Hathaway - PacifiCorp - 6**

**Answer** Yes

**Document Name**

**Comment**



Likes 0

Dislikes 0

**Response**

**Jodirah Green - ACES Power Marketing - 6, Group Name ACES Standard Collaborations**

**Answer**

Yes

**Document Name**

**Comment**

Likes 0

Dislikes 0

**Response**

**Maryanne Darling-Reich - Black Hills Corporation - 1,3,5,6 - WECC**

**Answer**

Yes

**Document Name**

**Comment**

Likes 0

Dislikes 0

**Response**

**Leonard Kula - Independent Electricity System Operator - 2**

**Answer**

Yes

**Document Name**

**Comment**

Likes 0

Dislikes 0

**Response**

**Tho Tran - Tho Tran On Behalf of: Lee Maurer, Oncor Electric Delivery, 1; - Tho Tran**

**Answer** Yes

**Document Name**

**Comment**

Likes 0

Dislikes 0

**Response**

**Rachel Coyne - Texas Reliability Entity, Inc. - 10**

**Answer** Yes

**Document Name**

**Comment**

Likes 0

Dislikes 0

**Response**

**David Jendras - Ameren - Ameren Services - 3**

**Answer** Yes

**Document Name**

**Comment**

Likes 0

Dislikes 0

**Response**

**Eli Rivera - Central Electric Cooperative, Inc. (Redmond, Oregon) - 1 - Texas RE**

**Answer** Yes

**Document Name**

**Comment**

Likes 0

Dislikes 0

**Response**

**William Sanders - Lower Colorado River Authority - 1**

**Answer**

Yes

**Document Name**

**Comment**

Likes 0

Dislikes 0

**Response**

**Douglas Webb - Douglas Webb On Behalf of: Allen Klassen, Westar Energy, 6, 3, 1, 5; Bryan Taggart, Westar Energy, 6, 3, 1, 5; Derek Brown, Westar Energy, 6, 3, 1, 5; Grant Wilkerson, Westar Energy, 6, 3, 1, 5; Harold Wyble, Great Plains Energy - Kansas City Power and Light Co., 5, 1, 3, 6; James McBee, Great Plains Energy - Kansas City Power and Light Co., 5, 1, 3, 6; Jennifer Flandermeyer, Great Plains Energy - Kansas City Power and Light Co., 5, 1, 3, 6; John Carlson, Great Plains Energy - Kansas City Power and Light Co., 5, 1, 3, 6; - Douglas Webb**

**Answer**

Yes

**Document Name**

**Comment**

Likes 0

Dislikes 0

**Response**

**Amber Orr - Public Utility District No. 1 of Pend Oreille County - 3**

**Answer**

Yes

**Document Name**

**Comment**

Likes 0

Dislikes 0

**Response**

**Pamela Hunter - Southern Company - Southern Company Services, Inc. - 1,3,5,6 - SERC, Group Name Southern Company**

**Answer** Yes

**Document Name**

**Comment**

Likes 0

Dislikes 0

**Response**

**Ryan Walter - Tri-State G and T Association, Inc. - 1,3,5 - MRO,WECC**

**Answer** Yes

**Document Name**

**Comment**

Likes 0

Dislikes 0

**Response**

**Constantin Chitescu - Ontario Power Generation Inc. - 5**

**Answer** Yes

**Document Name**

**Comment**

Likes 0

Dislikes 0

**Response**

**Chris Scanlon - Exelon - 1**

**Answer** Yes

**Document Name**

**Comment**

Likes 0

Dislikes 0

**Response**

**Todd Bennett - Associated Electric Cooperative, Inc. - 3, Group Name AECI**

**Answer**

**Document Name**

**Comment**

AECI supports the comments provided by NRECA.

Likes 0

Dislikes 0

**Response**

Thank you for your comments. Please see the SDT response to the NRECA comments.

**2. Guidelines and Technical Basis: The SDT made changes to the Guidelines and Technical Basis section of the Standard to conform with the modifications it made to Attachment 1, Section 5.2. Do you agree with these changes to the Guidelines and Technical Basis? If not, please provide the basis for your disagreement and an alternate proposal. (The CIP SDT is aware that another initiative is underway to convert all GTB sections to Technical Rationale documents. This effort is outside the scope of this SDT.)**

**Stephanie Burns - Stephanie Burns On Behalf of: Michael Moltane, International Transmission Company Holdings Corporation, 1; - Stephanie Burns**

**Answer** No

**Document Name**

**Comment**

ITC is in agreement with statements made by the NSRF:

The NSRF request that the entire Guideline and Technical Basis section should be removed from the Standard as it may be interpreted as how to meet the Compliance obligations of the Requirements. FERC Order 693 section 253 states, "The most critical element of a Reliability Standard is the Requirements. As NERC explains, "the Requirements within a standard define what an entity must do to be compliant . . . [and] binds an entity to certain obligations of performance under section 215 of the FPA." This information should reside out side the Standard as a NERC Compliance Guidance document.

Likes 0

Dislikes 0

**Response**

Thank you for your comment. There is a GTB initiative underway and the GTB will be removed and inserted into a separate document during the virtualization phase of this project.

**Andy Fuhrman - Andy Fuhrman On Behalf of: Theresa Allard, Minnkota Power Cooperative Inc., 1; - Andy Fuhrman**

**Answer** No

**Document Name**

**Comment**

Please refer to comments from the MRO NERC Standards Review Forum (NSRF).

Likes 0

Dislikes 0

**Response**

Thank you for your comment. Please see the SDT's response to the NSRF comments.

**Larry Watt - Lakeland Electric - 1**

**Answer** No

**Document Name**

**Comment**

The Guidelines and Technical Bases states contracts and vendor change management informatino would serve as evidence, but, in the experience of Lakeland Electric, providing procedural or contractual evidence does not seem to be a satisfactory evidence artifact to provide to the auditors when they are asking for evidence that a task was performed. The way it is written makes the auditability vague and subject to a lot of judgement which can create frustration for Responsible Entities if that approach is not consistent.

Likes 0

Dislikes 0

### Response

Thank you for your comment. Your comment addresses a section of the Guidelines and Technical Basis that was not modified by this SDT. The Guidelines and Technical Basis section is not intended to provide specific recommendations on compliance approaches. The SDT's understanding is that a team is in place working to remove the Guidelines and Technical Basis from the CIP standard and create new documents that align with the NERC Compliance Guidance Policy.

**Laura Nelson - IDACORP - Idaho Power Company - 1**

**Answer**

No

**Document Name**

**Comment**

The Guidelines and Technical Bases states contracts would serve as evidence, but, in the experience of Idaho Power Company, providing procedural or contractual evidence does not seem to be a satisfactory evidence artifact to provide to the auditors when they are asking for evidence that a task was performed prior to connecting a TCA they often require something that shows a task was performed. The way it is written makes the auditability vague and subject to a lot of judgement which can create frustration for Responsible Entities if that approach is not consistent.

Likes 0

Dislikes 0

### Response

Thank you for your comment. Your comment addresses a section of the Guidelines and Technical Basis that was not modified by this SDT. The Guidelines and Technical Basis section is not intended to provide specific recommendations on compliance approaches. The SDT's understanding is that a team is in place working to remove the Guidelines and Technical Basis from the CIP standard and creating new documents that align with the NERC Compliance Guidance Policy.

**Dana Klem - MRO - 1,2,3,4,5,6 - MRO, Group Name MRO NSRF**

**Answer**

No

**Document Name**

**Comment**

The NSRF request that the entire Guideline and Technical Basis section should be removed from the Standard as it may be interpreted as how to meet the Compliance obligations of the Requirements. FERC Order 693 section 253 states, "The most critical element of a Reliability Standard is the Requirements. As NERC explains, "the Requirements within a standard define what an entity must do to be compliant . . . [and] binds an entity to certain obligations of performance under section 215 of the FPA." This information should reside out side the Standard as a NERC Compliance Guidance document.

Likes 0

Dislikes 0

**Response**

Thank you for your comment. There is a GTB initiative underway and the GTB will be removed and inserted into a separate document during the virtualization phase of this project.

**Tyson Archie - Platte River Power Authority - 5**

**Answer** Yes

**Document Name**

**Comment**

There appears to be a disconnect between the intent as noted in the Guidelines and Technical Basis and the requirement documented in CIP-003-8, Attachment 1, 5.2.2. See Comment for Q1.

Likes 0

Dislikes 0

**Response**

Thank you for your comment. The SDT asserts that the intent noted in the Guidelines and Technical Basis is consistent with the language added to section 5.2.2 of CIP-003-8 Attachment 1. The Responsible Entity is responsible for determining whether additional mitigation actions are necessary.

**Anthony Jablonski - ReliabilityFirst - 10**

**Answer** Yes

**Document Name**

**Comment**

ReliabilityFirst agrees with the proposed modification.

Likes 0

Dislikes 0

**Response**

Thank you for your comment.

**Aaron Cavanaugh - Bonneville Power Administration - 1,3,5,6 - WECC**

**Answer** Yes

**Document Name**

**Comment**

None

Likes 0

Dislikes 0



**Response**

**Chris Scanlon - Exelon - 1**

**Answer** Yes

**Document Name**

**Comment**

Likes 0

Dislikes 0

**Response**

**Constantin Chitescu - Ontario Power Generation Inc. - 5**

**Answer** Yes

**Document Name**

**Comment**

Likes 0

Dislikes 0

**Response**

**Ryan Walter - Tri-State G and T Association, Inc. - 1,3,5 - MRO,WECC**

**Answer** Yes

**Document Name**

**Comment**

Likes 0

Dislikes 0

**Response**

**Pamela Hunter - Southern Company - Southern Company Services, Inc. - 1,3,5,6 - SERC, Group Name Southern Company**

**Answer** Yes

**Document Name**

<b>Comment</b>	
Likes 0	
Dislikes 0	
<b>Response</b>	
<b>Amber Orr - Public Utility District No. 1 of Pend Oreille County - 3</b>	
<b>Answer</b>	Yes
<b>Document Name</b>	
<b>Comment</b>	
Likes 0	
Dislikes 0	
<b>Response</b>	
<b>Douglas Webb - Douglas Webb On Behalf of: Allen Klassen, Westar Energy, 6, 3, 1, 5; Bryan Taggart, Westar Energy, 6, 3, 1, 5; Derek Brown, Westar Energy, 6, 3, 1, 5; Grant Wilkerson, Westar Energy, 6, 3, 1, 5; Harold Wyble, Great Plains Energy - Kansas City Power and Light Co., 5, 1, 3, 6; James McBee, Great Plains Energy - Kansas City Power and Light Co., 5, 1, 3, 6; Jennifer Flandermeyer, Great Plains Energy - Kansas City Power and Light Co., 5, 1, 3, 6; John Carlson, Great Plains Energy - Kansas City Power and Light Co., 5, 1, 3, 6; - Douglas Webb</b>	
<b>Answer</b>	Yes
<b>Document Name</b>	
<b>Comment</b>	
Likes 0	
Dislikes 0	
<b>Response</b>	
<b>William Sanders - Lower Colorado River Authority - 1</b>	
<b>Answer</b>	Yes
<b>Document Name</b>	
<b>Comment</b>	
Likes 0	

Dislikes 0

**Response**

**Eli Rivera - Central Electric Cooperative, Inc. (Redmond, Oregon) - 1 - Texas RE**

**Answer** Yes

**Document Name**

**Comment**

Likes 0

Dislikes 0

**Response**

**Andrey Komissarov - Andrey Komissarov On Behalf of: Daniel Frank, Sempra - San Diego Gas and Electric, 3, 5, 1; - Andrey Komissarov**

**Answer** Yes

**Document Name**

**Comment**

Likes 0

Dislikes 0

**Response**

**David Jendras - Ameren - Ameren Services - 3**

**Answer** Yes

**Document Name**

**Comment**

Likes 0

Dislikes 0

**Response**

**Rachel Coyne - Texas Reliability Entity, Inc. - 10**

**Answer** Yes

<b>Document Name</b>	
<b>Comment</b>	
Likes 0	
Dislikes 0	
<b>Response</b>	
<b>Tho Tran - Tho Tran On Behalf of: Lee Maurer, Oncor Electric Delivery, 1; - Tho Tran</b>	
<b>Answer</b>	Yes
<b>Document Name</b>	
<b>Comment</b>	
Likes 0	
Dislikes 0	
<b>Response</b>	
<b>Lana Smith - San Miguel Electric Cooperative, Inc. - 5 - Texas RE</b>	
<b>Answer</b>	Yes
<b>Document Name</b>	
<b>Comment</b>	
Likes 0	
Dislikes 0	
<b>Response</b>	
<b>Leonard Kula - Independent Electricity System Operator - 2</b>	
<b>Answer</b>	Yes
<b>Document Name</b>	
<b>Comment</b>	
Likes 0	
Dislikes 0	

**Response**

**Maryanne Darling-Reich - Black Hills Corporation - 1,3,5,6 - WECC**

**Answer** Yes

**Document Name**

**Comment**

Likes 0

Dislikes 0

**Response**

**Jodirah Green - ACES Power Marketing - 6, Group Name ACES Standard Collaborations**

**Answer** Yes

**Document Name**

**Comment**

Likes 0

Dislikes 0

**Response**

**Sandra Shaffer - Berkshire Hathaway - PacifiCorp - 6**

**Answer** Yes

**Document Name**

**Comment**

Likes 0

Dislikes 0

**Response**

**Douglas Johnson - American Transmission Company, LLC - 1**

**Answer** Yes

**Document Name**

**Comment**

Likes 0

Dislikes 0

**Response****Ruida Shu - Northeast Power Coordinating Council - 1,2,3,4,5,6,7,8,9,10 - NPCC, Group Name RSC no Dominion and HQ****Answer**

Yes

**Document Name****Comment**

Likes 0

Dislikes 0

**Response****Anton Vu - Los Angeles Department of Water and Power - 6****Answer**

Yes

**Document Name****Comment**

Likes 0

Dislikes 0

**Response****Colby Bellville - Duke Energy - 1,3,5,6 - FRCC,SERC,RF, Group Name Duke Energy****Answer**

Yes

**Document Name****Comment**

Likes 0

Dislikes 0

**Response**

**Nicholas Lauriat - Network and Security Technologies - 1**

Answer Yes

Document Name

Comment

Likes 0

Dislikes 0

Response

**faranak sarbaz - Los Angeles Department of Water and Power - 1**

Answer Yes

Document Name

Comment

Likes 0

Dislikes 0

Response

**Heather Morgan - EDP Renewables North America LLC - 5**

Answer Yes

Document Name

Comment

Likes 0

Dislikes 0

Response

**Karl Blaszkowski - CMS Energy - Consumers Energy Company - 3**

Answer Yes

Document Name

Comment

Likes 0

Dislikes 0

**Response**

**Russell Martin II - Salt River Project - 1,3,5,6 - WECC**

**Answer**

Yes

**Document Name**

**Comment**

Likes 0

Dislikes 0

**Response**

**Kevin Salsbury - Berkshire Hathaway - NV Energy - 5**

**Answer**

Yes

**Document Name**

**Comment**

Likes 0

Dislikes 0

**Response**

**Vivian Vo - APS - Arizona Public Service Co. - 3**

**Answer**

Yes

**Document Name**

**Comment**

Likes 0

Dislikes 0

**Response**



**Eric Ruskamp - Lincoln Electric System - 6**

<b>Answer</b>	Yes
---------------	-----

<b>Document Name</b>	
----------------------	--

<b>Comment</b>	
----------------	--

Likes	0
-------	---

Dislikes	0
----------	---

<b>Response</b>	
-----------------	--

**Dennis Sismaet - Northern California Power Agency - 6**

<b>Answer</b>	Yes
---------------	-----

<b>Document Name</b>	
----------------------	--

<b>Comment</b>	
----------------	--

Likes	0
-------	---

Dislikes	0
----------	---

<b>Response</b>	
-----------------	--

**Richard Jackson - U.S. Bureau of Reclamation - 1**

<b>Answer</b>	Yes
---------------	-----

<b>Document Name</b>	
----------------------	--

<b>Comment</b>	
----------------	--

Likes	0
-------	---

Dislikes	0
----------	---

<b>Response</b>	
-----------------	--

**James Anderson - CMS Energy - Consumers Energy Company - 1**

<b>Answer</b>	Yes
---------------	-----

<b>Document Name</b>	
----------------------	--

<b>Comment</b>	
----------------	--

Likes 0

Dislikes 0

**Response**

**Leanna Lamatrice - AEP - 3**

**Answer** Yes

**Document Name**

**Comment**

Likes 0

Dislikes 0

**Response**

**Julie Severino - FirstEnergy - FirstEnergy Corporation - 1, Group Name FirstEnergy**

**Answer** Yes

**Document Name**

**Comment**

Likes 0

Dislikes 0

**Response**

**Devin Shines - PPL - Louisville Gas and Electric Co. - 1,3,5,6 - SERC,RF, Group Name PPL NERC Registered Affiliates**

**Answer** Yes

**Document Name**

**Comment**

Likes 0

Dislikes 0

**Response**

**Chris Wagner - Santee Cooper - 1, Group Name Santee Cooper**

Answer	Yes
Document Name	
<b>Comment</b>	
Likes 0	
Dislikes 0	
<b>Response</b>	
<p><b>Joe Tarantino - Joe Tarantino On Behalf of: Arthur Starkovich, Sacramento Municipal Utility District, 4, 1, 5, 6, 3; Beth Tincher, Sacramento Municipal Utility District, 4, 1, 5, 6, 3; Jamie Cutlip, Sacramento Municipal Utility District, 4, 1, 5, 6, 3; Kevin Smith, Balancing Authority of Northern California, 1; Nicole Looney, Sacramento Municipal Utility District, 4, 1, 5, 6, 3; Susan Oto, Sacramento Municipal Utility District, 4, 1, 5, 6, 3; - Joe Tarantino</b></p>	
Answer	Yes
Document Name	
<b>Comment</b>	
Likes 0	
Dislikes 0	
<b>Response</b>	
<p><b>Todd Bennett - Associated Electric Cooperative, Inc. - 3, Group Name AECI</b></p>	
Answer	
Document Name	
<b>Comment</b>	
<p>AECI supports the comments provided by NRECA.</p>	
Likes 0	
Dislikes 0	
<b>Response</b>	
<p>Thank you for your comment. Please see the SDT response to the NRECA comments.</p>	

3. Implementation Plan: The SDT established the Implementation Plan to make the standard effective the later of (1) January 1, 2020, or (2) the first day of the first calendar quarter that is six (6) calendar months after the effective date of the applicable governmental authority's order approving the standard, or as otherwise provided for by the applicable governmental authority. Do you agree with this proposal? If you think an alternate effective date is needed, please provide a detailed explanation of actions and time needed.

Joe Tarantino - Joe Tarantino On Behalf of: Arthur Starkovich, Sacramento Municipal Utility District, 4, 1, 5, 6, 3; Beth Tincher, Sacramento Municipal Utility District, 4, 1, 5, 6, 3; Jamie Cutlip, Sacramento Municipal Utility District, 4, 1, 5, 6, 3; Kevin Smith, Balancing Authority of Northern California, 1; Nicole Looney, Sacramento Municipal Utility District, 4, 1, 5, 6, 3; Susan Oto, Sacramento Municipal Utility District, 4, 1, 5, 6, 3; - Joe Tarantino

Answer No

Document Name

Comment

Attachment 2 Section 5 part 2 indicates that contracts must be modified. Contract may take over 6 months to modify. Consider changing the implementation to span 12 months.

Likes 0

Dislikes 0

Response

Thank you for your comments. Section 5.2 of the measures refers to referencing contracts. The SDT asserts that the language inserted in 5.2.2 does not materially alter any contract expectations over CIP-003-7 standard, which has an implementation plan length of the first calendar quarter that is eighteen (18) calendar months after the effective date of the applicable governmental authority's order approve the standard.

Richard Jackson - U.S. Bureau of Reclamation - 1

Answer No

Document Name

Comment

Reclamation recommends CIP-003-8 become effective no earlier than 18 calendar months after the effective date of the applicable governmental authority's order approving the standard.

Likes 0

Dislikes 0

Response

Thank you for your comment. The SDT asserts that 6 months is a sufficient timeframe to make the adjustment to the low impact TCA program. This is due to the existing window to implement the low impact TCA program, the minimal change in program expectation, and the alignment with the existing language in CIP-010-2.

Dennis Sismaet - Northern California Power Agency - 6

<b>Answer</b>	No
<b>Document Name</b>	
<b>Comment</b>	
<p>Since CIP-003-8 incorporates the same language for Planned and Unplanned Changes in Section 5, as in the proposed CIP-002-6 standard, the revised standard should become effective the first day of the first calendarly quarter that is twenty-four (24) calendar months after the effective date of the applicable governmental authority's order approving the standard.</p> <p>This is to allow additional needed time for entities to prepare, plan, budget, procure, and hire additional labor resources to meet all the applicable reliability standards in becoming a Medium or High Impact entity from an existing Low-Impact entity. Cost estimates from consultants range anywhere from \$100,000.00 for consultant fees only, to \$1 million or more depending on computer hardware, facility hardening, and security software. This is especially burdensome for smaller entities, such as NCPA, who need more time, money, and approvals from it's governing board to make sure we have the funds and resources to properly prepare for and meet the new CIP reliability requirements.</p>	
Likes	0
Dislikes	0
<b>Response</b>	
<p>Thank you for your comment. The timeframe provided to implement CIP-003 for a planned or unplanned change is (as stated in the Effective Dates section) "on the date the Responsible Entity must comply with the requirements in Reliability Standard CIP-002 following a Planned Change or Unplanned Change." The timeline outlined in the Implementation Plan does not supersede the timeline provided due to a Planned or Unplanned Change.</p>	
<b>Laura Nelson - IDACORP - Idaho Power Company - 1</b>	
<b>Answer</b>	No
<b>Document Name</b>	
<b>Comment</b>	
<p>Efforts for TCAs associated with low impact assets and BES Cyber Systems is substantially more work than it was for the high and medium impact locations and systems. The workload is simply due to the sheer volume of locations and people that need to be included in the scope of the procedures. Idaho Power Company is working through the procedural efforts, but a 24-month implementation period seems more appropriate due to the work load of the low impact TCA process build out.</p>	
Likes	0
Dislikes	0
<b>Response</b>	
<p>Thank you for your comment. The SDT asserts that 6 months is a sufficient timeframe to make the adjustment to the low impact TCA program. This is due to the existing window to implement the low impact TCA program, the minimal change in program expectation, and the alignment with the existing language in CIP-010-2.</p>	
<b>Larry Watt - Lakeland Electric - 1</b>	
<b>Answer</b>	No
<b>Document Name</b>	
<b>Comment</b>	

Efforts for TCAs associated with low impact assets and BES Cyber Systems is substantially more work than it was for the high and medium impact locations and systems. The workload is simply due to the sheer volume of locations and people that need to be included in the scope of the procedures. Procedural efforts are in progress, but a 24-month implementation period seems more appropriate due to the work load of the low impact TCA process build out. Also for consideration, Attachment 2 Section 5 part 2 indicates that contracts must be modified. Contract may take over 6 months to modify. Consider changing the implementation to span a minimum of 12 months.

Likes 0

Dislikes 0

### Response

Thank you for your comment. The SDT asserts that 6 months is a sufficient timeframe to make the adjustment to the low impact TCA program. This is due to the existing window to implement the low impact TCA program, the minimal change in program expectation, and the alignment with the existing language in CIP-010-2.

Section 5.2 of the measures refers to referencing contracts. The SDT asserts, however, that the language inserted in 5.2.2 does not materially alter any contract expectations over the CIP-003-7 standard, which has an implementation plan of the first calendar quarter that is eighteen (18) calendar months after the effective date of the applicable governmental authority's order approve the standard.

**Jodirah Green - ACES Power Marketing - 6, Group Name ACES Standard Collaborations**

Answer

No

Document Name

Comment

This change causes an RE to review, change, update, and approve their CIP-003 documentation. Depending on when the standard is approved, this may not fall within the RE's 15 month programmatic review of CIP-003. Consequently, depending on the how the RE's program is designed, programmatic reviews are performed, and changes are implemented, this could have a significant resource impact. The number Low Impact BES CS are much greater than M and H making this change much broader and a greater level of effort than we believe the SDT anticipates.

Likes 0

Dislikes 0

### Response

Thank you for your comment. The SDT asserts that 6 months is a sufficient timeframe to make the adjustment to the low impact TCA program. This is due to the existing window to implement the low impact TCA program, the minimal change in program expectation, and the alignment with the existing language in CIP-010-2.

**Stephanie Burns - Stephanie Burns On Behalf of: Michael Moltane, International Transmission Company Holdings Corporation, 1; - Stephanie Burns**

Answer

No

Document Name

Comment

Do not believe 12 months is a good precedent.

Likes 0

Dislikes 0

<b>Response</b>	
Thank you for your comment. The SDT asserts that 6 months is a sufficient timeframe to make the adjustment to the low impact TCA program. This is due to the existing window to implement the low impact TCA program, the minimal change in program expectation, and the alignment with the existing language in CIP-010-2.	
<b>Eli Rivera - Central Electric Cooperative, Inc. (Redmond, Oregon) - 1 - Texas RE</b>	
<b>Answer</b>	No
<b>Document Name</b>	
<b>Comment</b>	
CenterPoint Energy Houston Electric, LLC ("CenterPoint Energy") recommends the effective date for CIP-003-8 to be 12 calendar months after FERC approval to allow entities time to coordinate with third-parties that connect their Transient Cyber Assets to low impact BES Cyber Systems.	
Likes 0	
Dislikes 0	
<b>Response</b>	
Thank you for your comment. The SDT asserts that 6 months is a sufficient timeframe to make the adjustment to the low impact TCA program. This is due to the existing window to implement the low impact TCA program, the minimal change in program expectation, and the alignment with the existing language in CIP-010-2.	
<b>Aaron Cavanaugh - Bonneville Power Administration - 1,3,5,6 - WECC</b>	
<b>Answer</b>	Yes
<b>Document Name</b>	
<b>Comment</b>	
None	
Likes 0	
Dislikes 0	
<b>Response</b>	
<b>Anthony Jablonski - ReliabilityFirst - 10</b>	
<b>Answer</b>	Yes
<b>Document Name</b>	
<b>Comment</b>	
ReliabilityFirst agrees with the proposed modification.	
Likes 0	
Dislikes 0	

**Response**

Thank you for your comment.

**Chris Wagner - Santee Cooper - 1, Group Name** Santee Cooper

**Answer** Yes

**Document Name**

**Comment**

Likes 0

Dislikes 0

**Response**

**Devin Shines - PPL - Louisville Gas and Electric Co. - 1,3,5,6 - SERC,RF, Group Name** PPL NERC Registered Affiliates

**Answer** Yes

**Document Name**

**Comment**

Likes 0

Dislikes 0

**Response**

**Julie Severino - FirstEnergy - FirstEnergy Corporation - 1, Group Name** FirstEnergy

**Answer** Yes

**Document Name**

**Comment**

Likes 0

Dislikes 0

**Response**

**Leanna Lamatrice - AEP - 3**

**Answer** Yes

**Document Name**



**Comment**

Likes 0

Dislikes 0

**Response****Dana Klem - MRO - 1,2,3,4,5,6 - MRO, Group Name MRO NSRF****Answer**

Yes

**Document Name****Comment**

Likes 0

Dislikes 0

**Response****Jeanne Kurzynowski - CMS Energy - Consumers Energy Company - 1,3,4,5 - RF****Answer**

Yes

**Document Name****Comment**

Likes 0

Dislikes 0

**Response****James Anderson - CMS Energy - Consumers Energy Company - 1****Answer**

Yes

**Document Name****Comment**

Likes 0

Dislikes 0

**Response**

**Eric Ruskamp - Lincoln Electric System - 6**

Answer Yes

Document Name

Comment

Likes 0

Dislikes 0

Response

**Vivian Vo - APS - Arizona Public Service Co. - 3**

Answer Yes

Document Name

Comment

Likes 0

Dislikes 0

Response

**Kevin Salsbury - Berkshire Hathaway - NV Energy - 5**

Answer Yes

Document Name

Comment

Likes 0

Dislikes 0

Response

**Tyson Archie - Platte River Power Authority - 5**

Answer Yes

Document Name

Comment

Likes 0

Dislikes 0

**Response**

**Russell Martin II - Salt River Project - 1,3,5,6 - WECC**

**Answer**

Yes

**Document Name**

**Comment**

Likes 0

Dislikes 0

**Response**

**Andy Fuhrman - Andy Fuhrman On Behalf of: Theresa Allard, Minnkota Power Cooperative Inc., 1; - Andy Fuhrman**

**Answer**

Yes

**Document Name**

**Comment**

Likes 0

Dislikes 0

**Response**

**Karl Blaszkowski - CMS Energy - Consumers Energy Company - 3**

**Answer**

Yes

**Document Name**

**Comment**

Likes 0

Dislikes 0

**Response**

**Heather Morgan - EDP Renewables North America LLC - 5**

**Answer** Yes

**Document Name**

**Comment**

Likes 0

Dislikes 0

**Response**

**faranak sarbaz - Los Angeles Department of Water and Power - 1**

**Answer** Yes

**Document Name**

**Comment**

Likes 0

Dislikes 0

**Response**

**Nicholas Lauriat - Network and Security Technologies - 1**

**Answer** Yes

**Document Name**

**Comment**

Likes 0

Dislikes 0

**Response**

**Colby Bellville - Duke Energy - 1,3,5,6 - FRCC,SERC,RF, Group Name Duke Energy**

**Answer** Yes

**Document Name**

**Comment**

Likes 0

Dislikes 0

**Response**

**Anton Vu - Los Angeles Department of Water and Power - 6**

**Answer**

Yes

**Document Name**

**Comment**

Likes 0

Dislikes 0

**Response**

**Ruida Shu - Northeast Power Coordinating Council - 1,2,3,4,5,6,7,8,9,10 - NPCC, Group Name RSC no Dominion and HQ**

**Answer**

Yes

**Document Name**

**Comment**

Likes 0

Dislikes 0

**Response**

**Douglas Johnson - American Transmission Company, LLC - 1**

**Answer**

Yes

**Document Name**

**Comment**

Likes 0

Dislikes 0

**Response**

**Sandra Shaffer - Berkshire Hathaway - PacifiCorp - 6**

Answer	Yes
Document Name	
Comment	
Likes 0	
Dislikes 0	
Response	
<b>Maryanne Darling-Reich - Black Hills Corporation - 1,3,5,6 - WECC</b>	
Answer	Yes
Document Name	
Comment	
Likes 0	
Dislikes 0	
Response	
<b>Leonard Kula - Independent Electricity System Operator - 2</b>	
Answer	Yes
Document Name	
Comment	
Likes 0	
Dislikes 0	
Response	
<b>Rachel Coyne - Texas Reliability Entity, Inc. - 10</b>	
Answer	Yes
Document Name	
Comment	
Likes 0	

Dislikes 0

**Response**

**David Jendras - Ameren - Ameren Services - 3**

**Answer** Yes

**Document Name**

**Comment**

Likes 0

Dislikes 0

**Response**

**Andrey Komissarov - Andrey Komissarov On Behalf of: Daniel Frank, Sempra - San Diego Gas and Electric, 3, 5, 1; - Andrey Komissarov**

**Answer** Yes

**Document Name**

**Comment**

Likes 0

Dislikes 0

**Response**

**William Sanders - Lower Colorado River Authority - 1**

**Answer** Yes

**Document Name**

**Comment**

Likes 0

Dislikes 0

**Response**

**Douglas Webb - Douglas Webb On Behalf of: Allen Klassen, Westar Energy, 6, 3, 1, 5; Bryan Taggart, Westar Energy, 6, 3, 1, 5; Derek Brown, Westar Energy, 6, 3, 1, 5; Grant Wilkerson, Westar Energy, 6, 3, 1, 5; Harold Wyble, Great Plains Energy - Kansas City Power and Light Co., 5,**

1, 3, 6; James McBee, Great Plains Energy - Kansas City Power and Light Co., 5, 1, 3, 6; Jennifer Flandermeyer, Great Plains Energy - Kansas City Power and Light Co., 5, 1, 3, 6; John Carlson, Great Plains Energy - Kansas City Power and Light Co., 5, 1, 3, 6; - Douglas Webb

Answer Yes

Document Name

Comment

Likes 0

Dislikes 0

Response

Amber Orr - Public Utility District No. 1 of Pend Oreille County - 3

Answer Yes

Document Name

Comment

Likes 0

Dislikes 0

Response

Pamela Hunter - Southern Company - Southern Company Services, Inc. - 1,3,5,6 - SERC, Group Name Southern Company

Answer Yes

Document Name

Comment

Likes 0

Dislikes 0

Response

Ryan Walter - Tri-State G and T Association, Inc. - 1,3,5 - MRO,WECC

Answer Yes

Document Name

Comment



Likes 0

Dislikes 0

**Response**

**Constantin Chitescu - Ontario Power Generation Inc. - 5**

**Answer**

Yes

**Document Name**

**Comment**

Likes 0

Dislikes 0

**Response**

**Chris Scanlon - Exelon - 1**

**Answer**

Yes

**Document Name**

**Comment**

Likes 0

Dislikes 0

**Response**

**Todd Bennett - Associated Electric Cooperative, Inc. - 3, Group Name AECI**

**Answer**

**Document Name**

**Comment**

AECI supports the comments provided by NRECA.

Likes 0

Dislikes 0

**Response**

Thank you for your comment. Please see the SDT's response to NRECA's comments.

4. The SDT believes proposed modifications in CIP-003-8 provide entities with flexibility to meet the reliability objectives in a cost effective manner. Do you agree? If you do not agree, or if you agree but have suggestions for improvement to enable more cost effective approaches, please provide your recommendation and, if appropriate, technical or procedural justification.

Jodirah Green - ACES Power Marketing - 6, Group Name ACES Standard Collaborations

Answer No

Document Name

Comment

By changing the Implementation Plan to be effective based on the RE's 15 month review of CIP-003 or 15 calendar months, instead of the planned dates, it allows the RE to plan for changes to it's program during a normal review period.

We thank the SDT for allowing us to provide comments on these standards and providing clarity.

Likes 0

Dislikes 0

Response

Thank you for your comments. The SDT appreciates the desire to coordinate program changes during a normal annual review cycle and understands that the proposed implementation plan may require program updates that are out-of-cycle. However, given that the requirement for the current low impact TCA program is not yet effective and the nature of the change introduced in Section 5.2.2 of CIP-003-8 Attachment 1, Responsible Entities that prefer to make adjustments during a normal review cycle should be able to incorporate this adjustment during a normal review period that may occur prior to FERC approval.

Karl Blaszkowski - CMS Energy - Consumers Energy Company - 3

Answer No

Document Name

Comment

NO, WE DO NOT ARGEE, as the language of the "Planned Changes" treats High, Medium and Low Impact BES Cyber Systems/Assets all the same. Specifically, when it comes to Low Impact System/Assets, the changes mandate less flexibility and would require immediate, "upon commissioning" compliance and rather than being documented and discovered during the once every 15 calendar months assessment, necessitate real-time tracking of all modification projects that might add to or change Low Impact BES Cyber Systems/Assets.

Additionally:

- Much of the language dates back to the Implementation Plan of CIP-002 rev 2 and the document, **Implementation Plan for Newly Identified Critical Cyber Assets** when the focus was on much more critical and essential cyber assets that could potentially, significantly impact the reliability of the BES. Applying these same implementation/new milestones (and thus immediately "upon commissioning") and requirements to Low Impact BES Cyber Systems/Assets in not appropriate to the risk.
- To put things in perspective, Low Impact BES Cyber Systems/Assets typically would have previously been considered "non-critical" cyber assets under the earlier CIP versions/requirements and thus required zero protections, ever. Although, this may have resulted previously in some gap in protection, it is with this background that newly identified Low Impact BES Cyber Systems/Assets needs to be viewed.

- As such, a compliance implementation milestone table needs to be again utilized for not only Unplanned Changes, but Planned Changes as well.
- Additionally, keeping in line with the once every 15 calendar months assessment of cyber systems/assets, Planned additions of Low Impact BES Cyber Systems/Assets should not require individual real-time tracking (that would be necessitated with compliance upon commissioning) and instead should be discovered during the once every 15 calendar months assessment and then compliant some time thereafter, following the assessment. ...12 months seems a reasonable duration for this.
- Further, in contrast and to put things in better perspective, allowing 12 months for a High-Impact BES Cyber System/Asset (Or 24 months if a new asset type) for an Unplanned Change and yet requiring a Low Impact BES Cyber System/Asset as part of a “planned” modification to be compliant upon commissioning makes little sense, especially in a risk-based environment.
- Planned additions of new (or recently re-categorized) Low Impact systems/assets should have an implementation table commensurate with their low-to-minimal-to-possibly virtually non-existent impact.

Likes 0

Dislikes 0

### Response

Thank you for your comment. The planned and unplanned change language was updated because the implementation plan for the version 5 standards contained ambiguous language. The decision to align the new planned and unplanned change language on the commissioning date was based in part on 2 factors: (1) The obligation to identify BES Cyber Systems in CIP-002-5.1 Requirement 1 is not a periodic requirement. The requirement to review and approve the list is at least once every 15 calendar months. There is no periodicity expressed for the identification of BES Cyber Systems.

(2) The implementation plan for the version 5 CIP standards states for Planned or Unplanned Changes Resulting in a Higher Categorization that “the responsible entity shall comply with all applicable requirements in the Version 5 CIP Cyber Security Standards on the update of the identification and categorization of the affected BES Cyber System.” It further states “...the new BES Cyber System has been implemented as a result of a planned change, and must, therefore, be in compliance with the Version 5 CIP Cyber Security Standards upon the commissioning...”

For planned changes, the assumption is, that time is allocated to include the security implementation as part of the overall project implementation. For unplanned changes, additional time is permitted as part of the compliance framework.

The SDT is moving the Planned/Unplanned changes language out of the CIP-003-8 Effective Date section and plans to include updated language in a future CIP-002 version. In the meantime, the CIP-003-8 Implementation Plan refers back to existing language in the CIP-003-7 Implementation Plan.

**Larry Watt - Lakeland Electric - 1**

**Answer**

No

**Document Name**

**Comment**

**Section 5.1 Planned and Unplanned Changes specifies 24 calendar months from the date of notification or detection of the Unplanned Change to become compliant with the new rating.**

**Consider first in the case of a Planner (RC, PC or TP) designating a whole generating station as necessary to avoid Adverse Reliability Impact (2.3) or critical to IROLs (2.6) Nothing about the BES Cyber Systems at that generating station has changed. Nothing can be corrected because the change is not based on megawatts or time. Instead, all the BES Cyber Systems must be made to conform to 8 additional standards. Some of these existing Low Impact BES Cyber Systems may have to be replaced because they are unsupported by patches and anti-malware.**

**24 Months is not enough time to take a Low Impact Facility and bring it into compliance as a Medium, especially for a generation facility. Budgets, new BES System design, equipment delivery, installation of equipment and patching, writing procedures, policy and**

processes, creating evidence and documentation are required to go from a Low Impact to a Medium Impact System and remain in compliance. Financially, the impact of this change will cost anywhere from hundreds of thousands to millions at a generating station of any size. This needs to be a minimum of 48 Months to be completed cost effectively.

Likes 0

Dislikes 0

**Response**

Thank you for your comment. The SDT asserts that 24 months is sufficient time to implement a medium or high impact CIP program. This timeframe is consistent with the Implementation Plan for Version 5 CIP Cyber Security Standards dated October 26, 2012 where initial compliance for medium and high impact BES Cyber Systems became mandatory.

**Tyson Archie - Platte River Power Authority - 5**

**Answer** No

**Document Name**

**Comment**

Section 5.1 Planned and Unplanned Changes specifies 24 calendar months from the date of notification or detection of the Unplanned Change to become compliant with the new rating.

Consider first in the case of a Planner (RC, PC or TP) designating a whole generating station as necessary to avoid Adverse Reliability Impact (2.3) or critical to IROLs (2.6) Nothing about the BES Cyber Systems at that generating station has changed. Nothing can be corrected because the change is not based on megawatts or time. Instead, all the BES Cyber Systems must be made to conform to 8 additional standards. Some of these existing Low Impact BES Cyber Systems may have to be replaced because they are unsupported by patches and anti-malware.

24 Months is not enough time to take a Low Impact Facility and bring it into compliance as a Medium, especially for a generation facility. Budgets, new BES System design, equipment delivery, installation of equipment and patching, writing procedures, policy and processes, creating evidence and documentation are required to go from a Low Impact to a Medium Impact System and remain in compliance. Financially, the impact of this change will cost anywhere from hundreds of thousands to millions at a generating station of any size. This needs to be a minimum of 48 Months to be completed cost effectively.

Likes 0

Dislikes 0

**Response**

Thank you for your comment. The SDT asserts that 24 months is sufficient time to implement a medium or high impact CIP program. This timeframe is consistent with the Implementation Plan for Version 5 CIP Cyber Security Standards dated October 26, 2012 where initial compliance for medium and high impact BES Cyber Systems became mandatory.

**Dennis Sismaet - Northern California Power Agency - 6**

**Answer** No

**Document Name**

**Comment**

There is no reason to change the existing two year time period in preparing to meet the new Medium or High impact CIP reliability requirements. The new requirement to start the clock running when a contract with a customer is signed to provide control center operation services to manage their generation facilities doesn't make sense if the net real power from the additional 100 MW nameplate capacity only results in 50 MW of net real power during the following summer months. It is possible that all the work, time, and money spent to go from Low to Medium impact based on a signed contract would be wasted if the net real power never reaches the 1500 MW threshold.

It would be better to keep the existing two year transition period which starts when the net real power reaches the 1500 MW threshold, regardless, when the control center operation service contract gets signed.

Likes 0

Dislikes 0

### Response

Thank you for your comment. The SDT asserts that the new planned and unplanned change language has no bearing on the criteria for determining whether a BES Cyber System is identified as high, medium, or low impact.

**Richard Jackson - U.S. Bureau of Reclamation - 1**

**Answer**

No

**Document Name**

**Comment**

Prior to proposing additional modifications, Reclamation recommends each SDT take additional time to effectively define the scope of each Standard Authorization Request to minimize the costs associated with the planning and adjustments required to achieve compliance with frequently changing requirements. This will provide entities with economical relief by allowing technical compliance with current standards.

Likes 0

Dislikes 0

### Response

Thank you for your comments.

**James Anderson - CMS Energy - Consumers Energy Company - 1**

**Answer**

No

**Document Name**

**Comment**

NO, WE DO NOT ARGEE, as the language of the "Planned Changes" treats High, Medium and Low Impact BES Cyber Systems/Assets all the same. Specifically, when it comes to Low Impact System/Assets, the changes mandate less flexibility and would require immediate, "upon commissioning" compliance and rather than being documented and discovered during the once every 15 calendar months assessment, necessitate real-time tracking of all modification projects that might add to or change Low Impact BES Cyber Systems/Assets.

Additionally:

- Much of the language dates back to the Implementation Plan of CIP-002 rev 2 and the document, **Implementation Plan for Newly Identified Critical Cyber Assets** when the focus was on much more critical and essential cyber assets that could potentially, significantly impact the

reliability of the BES. Applying these same implementation/new milestones (and thus immediately “upon commissioning”) and requirements to Low Impact BES Cyber Systems/Assets in not appropriate to the risk.

- To put things in perspective, Low Impact BES Cyber Systems/Assets typically would have previously been considered “non-critical” cyber assets under the earlier CIP versions/requirements and thus required zero protections, ever. Although, this may have resulted previously in some gap in protection, it is with this background that newly identified Low Impact BES Cyber Systems/Assets needs to be viewed.
- As such, a compliance implementation milestone table needs to be again utilized for not only Unplanned Changes, but Planned Changes as well.
- Additionally, keeping in line with the once every 15 calendar months assessment of cyber systems/assets, Planned additions of Low Impact BES Cyber Systems/Assets should not require individual real-time tracking (that would be necessitated with compliance upon commissioning) and instead should be discovered during the once every 15 calendar months assessment and then compliant some time thereafter, following the assessment. ...12 months seems a reasonable duration for this.
- Further, in contrast and to put things in better perspective, allowing 12 months for a High-Impact BES Cyber System/Asset (Or 24 months if a new asset type) for an Unplanned Change and yet requiring a Low Impact BES Cyber System/Asset as part of a “planned” modification to be compliant upon commissioning makes little sense, especially in a risk-based environment.
- Planned additions of new (or recently re-categorized) Low Impact systems/assets should have an implementation table commensurate with their low-to-minimal-to-possibly virtually non-existent impact.

Likes 0

Dislikes 0

### Response

Thank you for your comment. The planned and unplanned change language was updated as a result of language in the implementation plan for the version 5 standards that contained ambiguous language. The decision to align the new planned and unplanned change language on the commissioning date was based in part on 2 factors: (1) The obligation to identify BES Cyber Systems in CIP-002-5.1 Requirement 1 is not a periodic requirement. While the requirement to review and approve the list is required at least once every 15 calendar months, there is no periodicity expressed related to the identification of BES Cyber Systems.

(2) The implementation plan for the version 5 CIP standards states in the Planned or Unplanned Changes Resulting in a Higher Categorization that “the responsible entity shall comply with all applicable requirements in the Version 5 CIP Cyber Security Standards on the update of the identification and categorization of the affected BES Cyber System.” It further states “...the new BES Cyber System has been implemented as a result of a planned change, and must, therefore, be in compliance with the Version 5 CIP Cyber Security Standards upon the commissioning...”

For planned changes, the assumption is, consistent with a security culture, time is allocated to include the security implementation as part of the overall project implementation itself. For unplanned changes, additional time is permitted as part of the compliance framework.

The SDT is moving the Planned/Unplanned changes language out of the CIP-003-8 Effective Date section and plans to include updated language in a future CIP-002 version. In the meantime, the CIP-003-8 Implementation Plan refers back to existing language in the CIP-003-7 Implementation Plan.

**Jeanne Kurzynowski - CMS Energy - Consumers Energy Company - 1,3,4,5 - RF**

Answer

No

Document Name

Comment

NO, WE DO NOT ARGEE, as the language of the “Planned Changes” treats High, Medium and Low Impact BES Cyber Systems/Assets all the same. Specifically, when it comes to Low Impact System/Assets, the changes mandate less flexibility and would require immediate, “upon

commissioning” compliance and rather than being documented and discovered during the once every 15 calendar months assessment, necessitate real-time tracking of all modification projects that might add to or change Low Impact BES Cyber Systems/Assets.

Additionally:

- Much of the language dates back to the Implementation Plan of CIP-002 rev 2 and the document, **Implementation Plan for Newly Identified Critical Cyber Assets** when the focus was on much more critical and essential cyber assets that could potentially, significantly impact the reliability of the BES. Applying these same implementation/new milestones (and thus immediately “upon commissioning”) and requirements to Low Impact BES Cyber Systems/Assets in not appropriate to the risk.
- To put things in perspective, Low Impact BES Cyber Systems/Assets typically would have previously been considered “non-critical” cyber assets under the earlier CIP versions/requirements and thus required zero protections, ever. Although, this may have resulted previously in some gap in protection, it is with this background that newly identified Low Impact BES Cyber Systems/Assets needs to be viewed.
- As such, a compliance implementation milestone table needs to be again utilized for not only Unplanned Changes, but Planned Changes as well.
- Additionally, keeping in line with the once every 15 calendar months assessment of cyber systems/assets, Planned additions of Low Impact BES Cyber Systems/Assets should not require individual real-time tracking (that would be necessitated with compliance upon commissioning) and instead should be discovered during the once every 15 calendar months assessment and then compliant some time thereafter, following the assessment. ...12 months seems a reasonable duration for this.
- Further, in contrast and to put things in better perspective, allowing 12 months for a High-Impact BES Cyber System/Asset (Or 24 months if a new asset type) for an Unplanned Change and yet requiring a Low Impact BES Cyber System/Asset as part of a “planned” modification to be compliant upon commissioning makes little sense, especially in a risk-based environment.
- Planned additions of new (or recently re-categorized) Low Impact systems/assets should have an implementation table commensurate with their low-to-minimal-to-possibly virtually non-existent impact.

Likes 0

Dislikes 0

### Response

Thank you for your comment. The planned and unplanned change language was updated as a result of language in the implementation plan for the version 5 standards that contained ambiguous language. The decision to align the new planned and unplanned change language on the commissioning date was based in part on 2 factors: (1) The obligation to identify BES Cyber Systems in CIP-002-5.1 Requirement 1 is not a periodic requirement. While the requirement to review and approve the list is required at least once every 15 calendar months, there is no periodicity expressed related to the identification of BES Cyber Systems.

(2) The implementation plan for the version 5 CIP standards states in the Planned or Unplanned Changes Resulting in a Higher Categorization that “the responsible entity shall comply with all applicable requirements in the Version 5 CIP Cyber Security Standards on the update of the identification and categorization of the affected BES Cyber System.” It further states “...the new BES Cyber System has been implemented as a result of a planned change, and must, therefore, be in compliance with the Version 5 CIP Cyber Security Standards upon the commissioning...”

For planned changes, the assumption is, consistent with a security culture, time is allocated to include the security implementation as part of the overall project implementation itself. For unplanned changes, additional time is permitted as part of the compliance framework.

The SDT is moving the Planned/Unplanned changes language out of the CIP-003-8 Effective Date section and plans to include updated language in a future CIP-002 version. In the meantime, the CIP-003-8 Implementation Plan refers back to existing language in the CIP-003-7 Implementation Plan.

**Chris Wagner - Santee Cooper - 1, Group Name Santee Cooper**

**Answer**

No

**Document Name**



**Comment**

**Section 5.1 Planned and Unplanned Changes specifies 24 calendar months from the date of notification or detection of the Unplanned Change to become compliant with the new rating.**

**Consider first in the case of a Planner (RC, PC or TP) designating a whole generating station as necessary to avoid Adverse Reliability Impact (2.3) or critical to IROLs (2.6) Nothing about the BES Cyber Systems at that generating station has changed. Nothing can be corrected because the change is not based on megawatts or time. Instead, all the BES Cyber Systems must be made to conform to 8 additional standards. Some of these existing Low Impact BES Cyber Systems may have to be replaced because they are unsupported by patches and anti-malware.**

**24 Months is not enough time to take a Low Impact Facility and bring it into compliance as a Medium, especially for a generation facility. Budgets, new BES System design, equipment delivery, installation of equipment and patching, writing procedures, policy and processes, creating evidence and documentation are required to go from a Low Impact to a Medium Impact System and remain in compliance. Financially, the impact of this change will cost anywhere from hundreds of thousands to millions at a generating station of any size. This needs to be a minimum of 48 Months to be completed cost effectively.**

Likes 0

Dislikes 0

**Response**

Thank you for your comment. The SDT asserts that 24 months is sufficient time to implement a medium or high impact CIP program. This timeframe is consistent with the Implementation Plan for Version 5 CIP Cyber Security Standards dated October 26, 2012 where initial compliance for medium and high impact BES Cyber Systems became mandatory.

**Anthony Jablonski - ReliabilityFirst - 10**

**Answer**

Yes

**Document Name**

**Comment**

ReliabilityFirst agrees with the proposed modification.

Likes 0

Dislikes 0

**Response**

**Chris Scanlon - Exelon - 1**

**Answer**

Yes

**Document Name**

**Comment**

Likes 0

Dislikes 0

**Response**

**Constantin Chitescu - Ontario Power Generation Inc. - 5**

**Answer**

Yes

**Document Name**

**Comment**

Likes 0

Dislikes 0

**Response**

**Ryan Walter - Tri-State G and T Association, Inc. - 1,3,5 - MRO,WECC**

**Answer**

Yes

**Document Name**

**Comment**

Likes 0

Dislikes 0

**Response**

**Pamela Hunter - Southern Company - Southern Company Services, Inc. - 1,3,5,6 - SERC, Group Name Southern Company**

**Answer**

Yes

**Document Name**

**Comment**

Likes 0

Dislikes 0

**Response**

**Amber Orr - Public Utility District No. 1 of Pend Oreille County - 3**

**Answer**

Yes

<b>Document Name</b>	
<b>Comment</b>	
Likes 0	
Dislikes 0	
<b>Response</b>	
<p><b>Douglas Webb - Douglas Webb On Behalf of: Allen Klassen, Westar Energy, 6, 3, 1, 5; Bryan Taggart, Westar Energy, 6, 3, 1, 5; Derek Brown, Westar Energy, 6, 3, 1, 5; Grant Wilkerson, Westar Energy, 6, 3, 1, 5; Harold Wyble, Great Plains Energy - Kansas City Power and Light Co., 5, 1, 3, 6; James McBee, Great Plains Energy - Kansas City Power and Light Co., 5, 1, 3, 6; Jennifer Flandermeyer, Great Plains Energy - Kansas City Power and Light Co., 5, 1, 3, 6; John Carlson, Great Plains Energy - Kansas City Power and Light Co., 5, 1, 3, 6; - Douglas Webb</b></p>	
<b>Answer</b>	Yes
<b>Document Name</b>	
<b>Comment</b>	
Likes 0	
Dislikes 0	
<b>Response</b>	
<p><b>William Sanders - Lower Colorado River Authority - 1</b></p>	
<b>Answer</b>	Yes
<b>Document Name</b>	
<b>Comment</b>	
Likes 0	
Dislikes 0	
<b>Response</b>	
<p><b>Andrey Komissarov - Andrey Komissarov On Behalf of: Daniel Frank, Sempra - San Diego Gas and Electric, 3, 5, 1; - Andrey Komissarov</b></p>	
<b>Answer</b>	Yes
<b>Document Name</b>	
<b>Comment</b>	

Likes 0

Dislikes 0

**Response**

**Stephanie Burns - Stephanie Burns On Behalf of: Michael Moltane, International Transmission Company Holdings Corporation, 1; - Stephanie Burns**

**Answer**

Yes

**Document Name**

**Comment**

Likes 0

Dislikes 0

**Response**

**David Jendras - Ameren - Ameren Services - 3**

**Answer**

Yes

**Document Name**

**Comment**

Likes 0

Dislikes 0

**Response**

**Rachel Coyne - Texas Reliability Entity, Inc. - 10**

**Answer**

Yes

**Document Name**

**Comment**

Likes 0

Dislikes 0

**Response**

**Leonard Kula - Independent Electricity System Operator - 2****Answer** Yes**Document Name****Comment**

Likes 0

Dislikes 0

**Response****Maryanne Darling-Reich - Black Hills Corporation - 1,3,5,6 - WECC****Answer** Yes**Document Name****Comment**

Likes 0

Dislikes 0

**Response****Sandra Shaffer - Berkshire Hathaway - PacifiCorp - 6****Answer** Yes**Document Name****Comment**

Likes 0

Dislikes 0

**Response****Douglas Johnson - American Transmission Company, LLC - 1****Answer** Yes**Document Name****Comment**

Likes 0

Dislikes 0

**Response**

**Anton Vu - Los Angeles Department of Water and Power - 6**

**Answer**

Yes

**Document Name**

**Comment**

Likes 0

Dislikes 0

**Response**

**Colby Bellville - Duke Energy - 1,3,5,6 - FRCC,SERC,RF, Group Name Duke Energy**

**Answer**

Yes

**Document Name**

**Comment**

Likes 0

Dislikes 0

**Response**

**Nicholas Lauriat - Network and Security Technologies - 1**

**Answer**

Yes

**Document Name**

**Comment**

Likes 0

Dislikes 0

**Response**

**faranak sarbaz - Los Angeles Department of Water and Power - 1**

Answer	Yes
Document Name	
Comment	
Likes 0	
Dislikes 0	
Response	
<b>Heather Morgan - EDP Renewables North America LLC - 5</b>	
Answer	Yes
Document Name	
Comment	
Likes 0	
Dislikes 0	
Response	
<b>Andy Fuhrman - Andy Fuhrman On Behalf of: Theresa Allard, Minnkota Power Cooperative Inc., 1; - Andy Fuhrman</b>	
Answer	Yes
Document Name	
Comment	
Likes 0	
Dislikes 0	
Response	
<b>Russell Martin II - Salt River Project - 1,3,5,6 - WECC</b>	
Answer	Yes
Document Name	
Comment	
Likes 0	

Dislikes 0

**Response**

**Kevin Salsbury - Berkshire Hathaway - NV Energy - 5**

**Answer** Yes

**Document Name**

**Comment**

Likes 0

Dislikes 0

**Response**

**Vivian Vo - APS - Arizona Public Service Co. - 3**

**Answer** Yes

**Document Name**

**Comment**

Likes 0

Dislikes 0

**Response**

**Eric Ruskamp - Lincoln Electric System - 6**

**Answer** Yes

**Document Name**

**Comment**

Likes 0

Dislikes 0

**Response**

**Laura Nelson - IDACORP - Idaho Power Company - 1**

**Answer** Yes



<b>Document Name</b>	
<b>Comment</b>	
Likes 0	
Dislikes 0	
<b>Response</b>	
<b>Dana Klem - MRO - 1,2,3,4,5,6 - MRO, Group Name MRO NSRF</b>	
<b>Answer</b>	Yes
<b>Document Name</b>	
<b>Comment</b>	
Likes 0	
Dislikes 0	
<b>Response</b>	
<b>Leanna Lamatrice - AEP - 3</b>	
<b>Answer</b>	Yes
<b>Document Name</b>	
<b>Comment</b>	
Likes 0	
Dislikes 0	
<b>Response</b>	
<b>Julie Severino - FirstEnergy - FirstEnergy Corporation - 1, Group Name FirstEnergy</b>	
<b>Answer</b>	Yes
<b>Document Name</b>	
<b>Comment</b>	
Likes 0	
Dislikes 0	

<b>Response</b>	
<b>Devin Shines - PPL - Louisville Gas and Electric Co. - 1,3,5,6 - SERC,RF, Group Name PPL NERC Registered Affiliates</b>	
<b>Answer</b>	Yes
<b>Document Name</b>	
<b>Comment</b>	
Likes	0
Dislikes	0
<b>Response</b>	
<b>Joe Tarantino - Joe Tarantino On Behalf of: Arthur Starkovich, Sacramento Municipal Utility District, 4, 1, 5, 6, 3; Beth Tincher, Sacramento Municipal Utility District, 4, 1, 5, 6, 3; Jamie Cutlip, Sacramento Municipal Utility District, 4, 1, 5, 6, 3; Kevin Smith, Balancing Authority of Northern California, 1; Nicole Looney, Sacramento Municipal Utility District, 4, 1, 5, 6, 3; Susan Oto, Sacramento Municipal Utility District, 4, 1, 5, 6, 3; - Joe Tarantino</b>	
<b>Answer</b>	Yes
<b>Document Name</b>	
<b>Comment</b>	
Likes	0
Dislikes	0
<b>Response</b>	
<b>Eli Rivera - Central Electric Cooperative, Inc. (Redmond, Oregon) - 1 - Texas RE</b>	
<b>Answer</b>	
<b>Document Name</b>	
<b>Comment</b>	
No response.	
Likes	0
Dislikes	0
<b>Response</b>	

<b>Todd Bennett - Associated Electric Cooperative, Inc. - 3, Group Name AECI</b>	
<b>Answer</b>	
<b>Document Name</b>	
<b>Comment</b>	
AECI supports the comments provided by NRECA.	
Likes 0	
Dislikes 0	
<b>Response</b>	
Thank you for your comments. Please see the SDT response to the NRECA comments.	
<b>Jonathan Robbins - Seminole Electric Cooperative, Inc. - 1,3,4,5,6 - FRCC</b>	
<b>Answer</b>	
<b>Document Name</b>	
<b>Comment</b>	
No comments regarding modifications.	
Likes 0	
Dislikes 0	
<b>Response</b>	

# Unofficial Nomination Form

## Project Number 2016-02 Modifications to CIP Standards

**Do not** use this form for submitting nominations. Use the [electronic form](#) to submit nominations by **8 p.m. Eastern, Friday, March 29, 2019**. This unofficial version is provided to assist nominees in compiling the information necessary to submit the electronic form.

Additional information can be found on the [Project 2016-02 Modifications to the CIP Standards](#) page. If you have questions, contact [Jordan Mallory](#) (via email), or at 404-446-2589.

By submitting a nomination form, you are indicating your willingness and agreement to actively participate in face-to-face meetings and conference calls.

Previous drafting or review team experience is beneficial, but not required. A brief description of the desired qualifications, expected commitment, and other pertinent information is included below.

### **Project 2016-02 Modifications to CIP Standards**

This solicitation for nominations is to augment the existing Project 2016-02 Modifications to CIP Standards drafting team that is continuing to address the Standard Authorization Request. NERC is seeking individuals from the United States and Canada who possess experience in one or more of the following areas, but are not limited to:

- Virtualization;
- Cooperative representation;
- Canadian representation; and
- Guidelines and Technical Basis representation.

### **Standards Affected**

CIP-002-6, CIP-003-7, CIP-004-6, CIP-005-5, CIP-006-6, CIP-007-6, CIP-008-5, CIP-009-6, CIP-010-2, CIP-011-2, and CIP-012-1.

The time commitment for this project is expected to be up to four face-to-face meetings per quarter (on average two full working days each meeting) with conference calls scheduled as needed to meet the agreed-upon timeline the review or drafting team sets forth. Team members may also have side projects, either individually or by subgroup, to present to the larger team for discussion and review. Lastly, an important component of the review and drafting team effort is outreach. Members of the team will be expected to conduct industry outreach during the development process to support a successful project outcome.

<b>Name:</b>		
<b>Organization:</b>		
<b>Address:</b>		
<b>Telephone:</b>		
<b>E-mail:</b>		
<b>Please briefly describe your experience and qualifications to serve on the requested Standard Drafting Team (Bio):</b>		
<p><b>If you are currently a member of any NERC drafting team(s), please list each one here:</b></p> <input type="checkbox"/> Not currently on any active SAR or standard drafting team. <input type="checkbox"/> Currently a member of the following SAR or standard drafting team(s):		
<p><b>If you previously worked on any NERC drafting team(s), please identify each one here:</b></p> <input type="checkbox"/> No prior NERC SAR or standard drafting team. <input type="checkbox"/> Prior experience on the following team(s):		
<b>Select each NERC Region in which you have experience relevant to the Project for which you are volunteering:</b>		
<input type="checkbox"/> Texas RE <input type="checkbox"/> FRCC <input type="checkbox"/> MRO	<input type="checkbox"/> NPCC <input type="checkbox"/> RF <input type="checkbox"/> SERC	<input type="checkbox"/> WECC <input type="checkbox"/> NA – Not Applicable

Select each Industry Segment that you represent:	
<input type="checkbox"/>	1 — Transmission Owners
<input type="checkbox"/>	2 — RTOs, ISOs
<input type="checkbox"/>	3 — Load-serving Entities
<input type="checkbox"/>	4 — Transmission-dependent Utilities
<input type="checkbox"/>	5 — Electric Generators
<input type="checkbox"/>	6 — Electricity Brokers, Aggregators, and Marketers
<input type="checkbox"/>	7 — Large Electricity End Users
<input type="checkbox"/>	8 — Small Electricity End Users
<input type="checkbox"/>	9 — Federal, State, and Provincial Regulatory or other Government Entities
<input type="checkbox"/>	10 — Regional Reliability Organizations and Regional Entities
<input type="checkbox"/>	NA — Not Applicable
Select each Function <sup>1</sup> in which you have current or prior expertise:	
<input type="checkbox"/> Balancing Authority	<input type="checkbox"/> Transmission Operator
<input type="checkbox"/> Compliance Enforcement Authority	<input type="checkbox"/> Transmission Owner
<input type="checkbox"/> Distribution Provider	<input type="checkbox"/> Transmission Planner
<input type="checkbox"/> Generator Operator	<input type="checkbox"/> Transmission Service Provider
<input type="checkbox"/> Generator Owner	<input type="checkbox"/> Purchasing-selling Entity
<input type="checkbox"/> Interchange Authority	<input type="checkbox"/> Reliability Coordinator
<input type="checkbox"/> Load-serving Entity	<input type="checkbox"/> Reliability Assurer
<input type="checkbox"/> Market Operator	<input type="checkbox"/> Resource Planner
<input type="checkbox"/> Planning Coordinator	

<sup>1</sup> These functions are defined in the NERC [Functional Model](#), which is available on the NERC web site.

**Provide the names and contact information of two references who could attest to your technical qualifications and your ability to work well in a group:**

Name:		Telephone:	
Organization:		E-mail:	
Name:		Telephone:	
Organization:		E-mail:	

**Provide the name and contact information of your immediate supervisor or a member of your management who can confirm your organization's willingness to support your active participation.**

Name:		Telephone:	
Title:		Email:	

# Standards Announcement

## Project 2016-02 Modifications to CIP Standards

**Nomination Period Open through March 29, 2019**

### [Now Available](#)

Nominations are being sought for standard drafting team members through **8 p.m. Eastern, Friday, March 29, 2019.**

Use the [electronic form](#) to submit a nomination. If you experience difficulties using the electronic form, contact [Wendy Muller](#). An unofficial Word version of the nomination form is posted on the [Standard Drafting Team Vacancies](#) and the [project page](#).

By submitting a nomination form, you are indicating your willingness and agreement to actively participate in face-to-face meetings and conference calls.

Previous drafting or review team experience is beneficial, but not required. A brief description of the desired qualifications, expected commitment, and other pertinent information is included below.

### **Project 2016-02 Modifications to CIP Standards**

This solicitation for nominations is to augment the existing Project 2016-02 Modifications to CIP Standards drafting team that is continuing to address the Standard Authorization Request. NERC is seeking individuals from the United States and Canada who possess experience in one or more of the following areas, but are not limited to:

- Virtualization;
- Cooperative representation;
- Canadian representation; and
- Guidelines and Technical Basis representation.

### **Standards Affected**

CIP-002-6, CIP-003-7, CIP-004-6, CIP-005-5, CIP-006-6, CIP-007-6, CIP-008-5, CIP-009-6, CIP-010-2, CIP-011-2, and CIP-012-1.

The time commitment for this project is expected to be up to four face-to-face meetings per quarter (on average two full working days each meeting) with conference calls scheduled as needed to meet the agreed-upon timeline the review or drafting team sets forth. Team members may also have side projects, either individually or by subgroup, to present to the larger team for discussion and review. Lastly, an important component of the review and drafting team effort is outreach. Members of the team will be expected to conduct industry outreach during the development process to support a successful project outcome.



## Next Steps

The Standards Committee is expected to appoint members to the team in April 2019. Nominees will be notified shortly after they have been appointed.

For information on the Standards Development Process, refer to the [Standard Processes Manual](#).

For more information or assistance, contact Standards Developer, [Jordan Mallory](#) (via email) or at (404) 446-2589.

North American Electric Reliability Corporation  
3353 Peachtree Rd, NE  
Suite 600, North Tower  
Atlanta, GA 30326  
404-446-2560 | [www.nerc.com](http://www.nerc.com)

## Standard Development Timeline

This section is maintained by the drafting team during the development of the standard and will be removed when the standard is adopted by the NERC Board of Trustees (Board).

### Description of Current Draft

10-day final ballot.

Completed Actions	Date
Standards Committee approved Standard Authorization Request (SAR) for posting	June 13, 2018
SAR posted for comment	June 14 – July 13, 2018
45-day formal comment period with ballot (initial)	August 23 – October 9, 2018

Anticipated Actions	Date
10-day final ballot	April 18 – 29, 2019
Board adoption	May 8, 2019

## A. Introduction

1. **Title:** Cyber Security — Security Management Controls
2. **Number:** CIP-003-8
3. **Purpose:** To specify consistent and sustainable security management controls that establish responsibility and accountability to protect BES Cyber Systems against compromise that could lead to misoperation or instability in the Bulk Electric System (BES).

### 4. Applicability:

**4.1. Functional Entities:** For the purpose of the requirements contained herein, the following list of functional entities will be collectively referred to as “Responsible Entities.” For requirements in this standard where a specific functional entity or subset of functional entities are the applicable entity or entities, the functional entity or entities are specified explicitly.

#### 4.1.1. Balancing Authority

**4.1.2. Distribution Provider** that owns one or more of the following Facilities, systems, and equipment for the protection or restoration of the BES:

**4.1.2.1.** Each underfrequency Load shedding (UFLS) or undervoltage Load shedding (UVLS) system that:

**4.1.2.1.1.** is part of a Load shedding program that is subject to one or more requirements in a NERC or Regional Reliability Standard; and

**4.1.2.1.2.** performs automatic Load shedding under a common control system owned by the Responsible Entity, without human operator initiation, of 300 MW or more.

**4.1.2.2.** Each Remedial Action Scheme (RAS) where the RAS is subject to one or more requirements in a NERC or Regional Reliability Standard.

**4.1.2.3.** Each Protection System (excluding UFLS and UVLS) that applies to Transmission where the Protection System is subject to one or more requirements in a NERC or Regional Reliability Standard.

**4.1.2.4.** Each Cranking Path and group of Elements meeting the initial switching requirements from a Blackstart Resource up to and including the first interconnection point of the starting station service of the next generation unit(s) to be started.

#### 4.1.3. Generator Operator

#### 4.1.4. Generator Owner

#### 4.1.5. Reliability Coordinator

#### 4.1.6. Transmission Operator

**4.1.7. Transmission Owner**

**4.2. Facilities:** For the purpose of the requirements contained herein, the following Facilities, systems, and equipment owned by each Responsible Entity in Section 4.1 above are those to which these requirements are applicable. For requirements in this standard where a specific type of Facilities, system, or equipment or subset of Facilities, systems, and equipment are applicable, these are specified explicitly.

**4.2.1. Distribution Provider:** One or more of the following Facilities, systems and equipment owned by the Distribution Provider for the protection or restoration of the BES:

**4.2.1.1.** Each UFLS or UVLS System that:

**4.2.1.1.1.** is part of a Load shedding program that is subject to one or more requirements in a NERC or Regional Reliability Standard; and

**4.2.1.1.2.** performs automatic Load shedding under a common control system owned by the Responsible Entity, without human operator initiation, of 300 MW or more.

**4.2.1.2.** Each RAS where the RAS is subject to one or more requirements in a NERC or Regional Reliability Standard.

**4.2.1.3.** Each Protection System (excluding UFLS and UVLS) that applies to Transmission where the Protection System is subject to one or more requirements in a NERC or Regional Reliability Standard.

**4.2.1.4.** Each Cranking Path and group of Elements meeting the initial switching requirements from a Blackstart Resource up to and including the first interconnection point of the starting station service of the next generation unit(s) to be started.

**4.2.2. Responsible Entities listed in 4.1 other than Distribution Providers:**

All BES Facilities.

**4.2.3. Exemptions:** The following are exempt from Standard CIP-003-8:

**4.2.3.1.** Cyber Assets at Facilities regulated by the Canadian Nuclear Safety Commission.

**4.2.3.2.** Cyber Assets associated with communication networks and data communication links between discrete Electronic Security Perimeters (ESPs).

**4.2.3.3.** The systems, structures, and components that are regulated by the Nuclear Regulatory Commission under a cyber security plan pursuant to 10 C.F.R. Section 73.54.

**4.2.3.4.** For Distribution Providers, the systems and equipment that are not included in section 4.2.1 above.

**5. Effective Dates:**

See Implementation Plan for CIP-003-8.

**6. Background:**

Standard CIP-003 exists as part of a suite of CIP Standards related to cyber security, which require the initial identification and categorization of BES Cyber Systems and require organizational, operational, and procedural controls to mitigate risk to BES Cyber Systems.

The term policy refers to one or a collection of written documents that are used to communicate the Responsible Entities' management goals, objectives and expectations for how the Responsible Entity will protect its BES Cyber Systems. The use of policies also establishes an overall governance foundation for creating a culture of security and compliance with laws, regulations, and standards.

The term documented processes refers to a set of required instructions specific to the Responsible Entity and to achieve a specific outcome. This term does not imply any naming or approval structure beyond what is stated in the requirements. An entity should include as much as it believes necessary in its documented processes, but it must address the applicable requirements.

The terms program and plan are sometimes used in place of documented processes where it makes sense and is commonly understood. For example, documented processes describing a response are typically referred to as plans (i.e., incident response plans and recovery plans). Likewise, a security plan can describe an approach involving multiple procedures to address a broad subject matter.

Similarly, the term program may refer to the organization's overall implementation of its policies, plans, and procedures involving a subject matter. Examples in the standards include the personnel risk assessment program and the personnel training program. The full implementation of the CIP Cyber Security Reliability Standards could also be referred to as a program. However, the terms program and plan do not imply any additional requirements beyond what is stated in the standards.

Responsible Entities can implement common controls that meet requirements for multiple high, medium, and low impact BES Cyber Systems. For example, a single cyber security awareness program could meet the requirements across multiple BES Cyber Systems.

Measures provide examples of evidence to show documentation and implementation of the requirement. These measures serve to provide guidance to entities in acceptable records of compliance and should not be viewed as an all-inclusive list.

Throughout the standards, unless otherwise stated, bulleted items in the requirements and measures are items that are linked with an "or," and numbered items are items that are linked with an "and."

Many references in the Applicability section use a threshold of 300 MW for UFLS and UVLS. This particular threshold of 300 MW for UVLS and UFLS was provided in Version 1 of the CIP Cyber Security Standards. The threshold remains at 300 MW since it is specifically addressing UVLS and UFLS, which are last ditch efforts to save the BES. A review of UFLS

tolerances defined within Regional Reliability Standards for UFLS program requirements to date indicates that the historical value of 300 MW represents an adequate and reasonable threshold value for allowable UFLS operational tolerances.

## B. Requirements and Measures

- R1.** Each Responsible Entity shall review and obtain CIP Senior Manager approval at least once every 15 calendar months for one or more documented cyber security policies that collectively address the following topics: *[Violation Risk Factor: Medium] [Time Horizon: Operations Planning]*
- 1.1.** For its high impact and medium impact BES Cyber Systems, if any:
    - 1.1.1.** Personnel and training (CIP-004);
    - 1.1.2.** Electronic Security Perimeters (CIP-005) including Interactive Remote Access;
    - 1.1.3.** Physical security of BES Cyber Systems (CIP-006);
    - 1.1.4.** System security management (CIP-007);
    - 1.1.5.** Incident reporting and response planning (CIP-008);
    - 1.1.6.** Recovery plans for BES Cyber Systems (CIP-009);
    - 1.1.7.** Configuration change management and vulnerability assessments (CIP-010);
    - 1.1.8.** Information protection (CIP-011); and
    - 1.1.9.** Declaring and responding to CIP Exceptional Circumstances.
  - 1.2.** For its assets identified in CIP-002 containing low impact BES Cyber Systems, if any:
    - 1.2.1.** Cyber security awareness;
    - 1.2.2.** Physical security controls;
    - 1.2.3.** Electronic access controls;
    - 1.2.4.** Cyber Security Incident response;
    - 1.2.5.** Transient Cyber Assets and Removable Media malicious code risk mitigation; and
    - 1.2.6.** Declaring and responding to CIP Exceptional Circumstances.
- M1.** Examples of evidence may include, but are not limited to, policy documents; revision history, records of review, or workflow evidence from a document management system that indicate review of each cyber security policy at least once every 15 calendar months; and documented approval by the CIP Senior Manager for each cyber security policy.
- R2.** Each Responsible Entity with at least one asset identified in CIP-002 containing low impact BES Cyber Systems shall implement one or more documented cyber security plan(s) for its low impact BES Cyber Systems that include the sections in Attachment 1. *[Violation Risk Factor: Lower] [Time Horizon: Operations Planning]*

Note: An inventory, list, or discrete identification of low impact BES Cyber Systems or their BES Cyber Assets is not required. Lists of authorized users are not required.

- M2.** Evidence shall include each of the documented cyber security plan(s) that collectively include each of the sections in Attachment 1 and additional evidence to demonstrate implementation of the cyber security plan(s). Additional examples of evidence per section are located in Attachment 2.
- R3.** Each Responsible Entity shall identify a CIP Senior Manager by name and document any change within 30 calendar days of the change. *[Violation Risk Factor: Medium]*  
*[Time Horizon: Operations Planning]*
- M3.** An example of evidence may include, but is not limited to, a dated and approved document from a high level official designating the name of the individual identified as the CIP Senior Manager.
- R4.** The Responsible Entity shall implement a documented process to delegate authority, unless no delegations are used. Where allowed by the CIP Standards, the CIP Senior Manager may delegate authority for specific actions to a delegate or delegates. These delegations shall be documented, including the name or title of the delegate, the specific actions delegated, and the date of the delegation; approved by the CIP Senior Manager; and updated within 30 days of any change to the delegation. Delegation changes do not need to be reinstated with a change to the delegator. *[Violation Risk Factor: Lower]* *[Time Horizon: Operations Planning]*
- M4.** An example of evidence may include, but is not limited to, a dated document, approved by the CIP Senior Manager, listing individuals (by name or title) who are delegated the authority to approve or authorize specifically identified items.



## C. Compliance

### 1. Compliance Monitoring Process

#### 1.1. Compliance Enforcement Authority:

As defined in the NERC Rules of Procedure, “Compliance Enforcement Authority” (CEA) means NERC or the Regional Entity in their respective roles of monitoring and enforcing compliance with the NERC Reliability Standards.

#### 1.2. Evidence Retention:

The following evidence retention periods identify the period of time an entity is required to retain specific evidence to demonstrate compliance. For instances where the evidence retention period specified below is shorter than the time since the last audit, the CEA may ask an entity to provide other evidence to show that it was compliant for the full time period since the last audit.

The Responsible Entity shall keep data or evidence to show compliance as identified below unless directed by its CEA to retain specific evidence for a longer period of time as part of an investigation:

- Each Responsible Entity shall retain evidence of each requirement in this standard for three calendar years.
- If a Responsible Entity is found non-compliant, it shall keep information related to the non-compliance until mitigation is complete and approved or for the time specified above, whichever is longer.
- The CEA shall keep the last audit records and all requested and submitted subsequent audit records.

#### 1.3. Compliance Monitoring and Assessment Processes:

- Compliance Audits
- Self-Certifications
- Spot Checking
- Compliance Investigations
- Self-Reporting
- Complaints

#### 1.4. Additional Compliance Information:

None.

### Violation Severity Levels

R #	Time Horizon	VRF	Violation Severity Levels (CIP-003-8)			
			Lower VSL	Moderate VSL	High VSL	Severe VSL
<b>R1</b>	<b>Operations Planning</b>	<b>Medium</b>	<p>The Responsible Entity documented and implemented one or more cyber security policies for its high impact and medium impact BES Cyber Systems, but did not address one of the nine topics required by R1. (R1.1)</p> <p>OR</p> <p>The Responsible Entity did not complete its review of the one or more documented cyber security policies for its high impact and medium impact BES Cyber Systems as required by R1 within 15 calendar months but did</p>	<p>The Responsible Entity documented and implemented one or more cyber security policies for its high impact and medium impact BES Cyber Systems, but did not address two of the nine topics required by R1. (R1.1)</p> <p>OR</p> <p>The Responsible Entity did not complete its review of the one or more documented cyber security policies for its high impact and medium impact BES Cyber Systems as required by R1 within 16 calendar months but did</p>	<p>The Responsible Entity documented and implemented one or more cyber security policies for its high impact and medium impact BES Cyber Systems, but did not address three of the nine topics required by R1. (R1.1)</p> <p>OR</p> <p>The Responsible Entity did not complete its review of the one or more documented cyber security policies for its high impact and medium impact BES Cyber Systems as required by R1 within 17 calendar months but did complete this review in less than or equal to 18</p>	<p>The Responsible Entity documented and implemented one or more cyber security policies for its high impact and medium impact BES Cyber Systems, but did not address four or more of the nine topics required by R1. (R1.1)</p> <p>OR</p> <p>The Responsible Entity did not have any documented cyber security policies for its high impact and medium impact BES Cyber Systems as required by R1. (R1.1)</p> <p>OR</p> <p>The Responsible Entity did not</p>

R #	Time Horizon	VRF	Violation Severity Levels (CIP-003-8)			
			Lower VSL	Moderate VSL	High VSL	Severe VSL
			complete this review in less than or equal to 16 calendar months of the previous review. (R1.1) OR The Responsible Entity did not complete its approval of the one or more documented cyber security policies for its high impact and medium impact BES Cyber Systems as required by R1 by the CIP Senior Manager within 15 calendar months but did complete this approval in less than or equal to 16 calendar months of the previous approval. (R1.1)	complete this review in less than or equal to 17 calendar months of the previous review. (R1.1) OR The Responsible Entity did not complete its approval of the one or more documented cyber security policies for its high impact and medium impact BES Cyber Systems as required by R1 by the CIP Senior Manager within 16 calendar months but did complete this approval in less than or equal to 17 calendar months of the previous approval. (R1.1)	calendar months of the previous review. (R1.1) OR The Responsible Entity did not complete its approval of the one or more documented cyber security policies for its high impact and medium impact BES Cyber Systems as required by R1 by the CIP Senior Manager within 17 calendar months but did complete this approval in less than or equal to 18 calendar months of the previous approval. (R1) OR The Responsible Entity documented one or more cyber security policies for its assets identified in CIP-002 containing low impact	complete its review of the one or more documented cyber security policies as required by R1 within 18 calendar months of the previous review. (R1) OR The Responsible Entity did not complete its approval of the one or more documented cyber security policies for its high impact and medium impact BES Cyber Systems as required by R1 by the CIP Senior Manager within 18 calendar months of the previous approval. (R1.1) OR

R #	Time Horizon	VRF	Violation Severity Levels (CIP-003-8)			
			Lower VSL	Moderate VSL	High VSL	Severe VSL
			<p>OR</p> <p>The Responsible Entity documented one or more cyber security policies for its assets identified in CIP-002 containing low impact BES Cyber Systems, but did not address one of the six topics required by R1. (R1.2)</p> <p>OR</p> <p>The Responsible Entity did not complete its review of the one or more documented cyber security policies for its assets identified in CIP-002 containing low impact BES Cyber Systems as required by Requirement R1 within 15 calendar</p>	<p>OR</p> <p>The Responsible Entity documented one or more cyber security policies for its assets identified in CIP-002 containing low impact BES Cyber Systems, but did not address two of the six topics required by R1. (R1.2)</p> <p>OR</p> <p>The Responsible Entity did not complete its review of the one or more documented cyber security policies for its assets identified in CIP-002 containing low impact BES Cyber Systems as required by Requirement R1 within 16 calendar</p>	<p>BES Cyber Systems, but did not address three of the six topics required by R1. (R1.2)</p> <p>OR</p> <p>The Responsible Entity did not complete its review of the one or more documented cyber security policies for its assets identified in CIP-002 containing low impact BES Cyber Systems as required by R1 within 17 calendar months but did complete this review in less than or equal to 18 calendar months of the previous review. (R1.2)</p> <p>OR</p> <p>The Responsible Entity did not complete its approval of the one or more documented cyber security policies for its</p>	<p>The Responsible Entity documented one or more cyber security policies for its assets identified in CIP-002 containing low impact BES Cyber Systems, but did not address four or more of the six topics required by R1. (R1.2)</p> <p>OR</p> <p>The Responsible Entity did not have any documented cyber security policies for its assets identified in CIP-002 containing low impact BES Cyber Systems as required by R1. (R1.2)</p> <p>OR</p> <p>The Responsible Entity did not</p>

R #	Time Horizon	VRF	Violation Severity Levels (CIP-003-8)			
			Lower VSL	Moderate VSL	High VSL	Severe VSL
			<p>months but did complete this review in less than or equal to 16 calendar months of the previous review. (R1.2)</p> <p>OR</p> <p>The Responsible Entity did not complete its approval of the one or more documented cyber security policies for its assets identified in CIP-002 containing low impact BES Cyber Systems as required by Requirement R1 by the CIP Senior Manager within 15 calendar months but did complete this approval in less than or equal to 16 calendar months of</p>	<p>months but did complete this review in less than or equal to 17 calendar months of the previous review. (R1.2)</p> <p>OR</p> <p>The Responsible Entity did not complete its approval of the one or more documented cyber security policies for its assets identified in CIP-002 containing low impact BES Cyber Systems as required by Requirement R1 by the CIP Senior Manager within 16 calendar months but did complete this approval in less than or equal to 17</p>	<p>assets identified in CIP-002 containing low impact BES Cyber Systems as required by Requirement R1 by the CIP Senior Manager within 17 calendar months but did complete this approval in less than or equal to 18 calendar months of the previous approval. (R1.2)</p>	<p>complete its approval of the one or more documented cyber security policies for its assets identified in CIP-002 containing low impact BES Cyber Systems as required by Requirement R1 by the CIP Senior Manager within 18 calendar months of the previous approval. (R1.2)</p>

R #	Time Horizon	VRF	Violation Severity Levels (CIP-003-8)			
			Lower VSL	Moderate VSL	High VSL	Severe VSL
			the previous approval. (R1.2)	calendar months of the previous approval. (R1.2)		
<b>R2</b>	<b>Operations Planning</b>	<b>Lower</b>	<p>The Responsible Entity documented its cyber security plan(s) for its assets containing low impact BES Cyber Systems, but failed to document cyber security awareness according to Requirement R2, Attachment 1, Section 1. (R2)</p> <p>OR</p> <p>The Responsible Entity implemented electronic access controls but failed to document its cyber security plan(s) for electronic access controls according to Requirement R2,</p>	<p>The Responsible Entity documented its cyber security plan(s) for its assets containing low impact BES Cyber Systems, but failed to reinforce cyber security practices at least once every 15 calendar months according to Requirement R2, Attachment 1, Section 1. (R2)</p> <p>OR</p> <p>The Responsible Entity documented its cyber security plan(s) for its assets containing low impact BES Cyber Systems, but failed</p>	<p>The Responsible Entity documented the physical access controls for its assets containing low impact BES Cyber Systems, but failed to implement the physical security controls according to Requirement R2, Attachment 1, Section 2. (R2)</p> <p>OR</p> <p>The Responsible Entity documented its cyber security plan(s) for electronic access controls for its assets containing low impact BES Cyber Systems, but failed to permit only necessary inbound and outbound electronic</p>	<p>The Responsible Entity failed to document and implement one or more cyber security plan(s) for its assets containing low impact BES Cyber Systems according to Requirement R2, Attachment 1. (R2)</p>

R #	Time Horizon	VRF	Violation Severity Levels (CIP-003-8)			
			Lower VSL	Moderate VSL	High VSL	Severe VSL
			<p>Attachment 1, Section 3. (R2)</p> <p>OR</p> <p>The Responsible Entity documented its cyber security plan(s) for its assets containing low impact BES Cyber Systems, but failed to document one or more Cyber Security Incident response plan(s) according to Requirement R2, Attachment 1, Section 4. (R2)</p> <p>OR</p> <p>The Responsible Entity documented one or more Cyber Security Incident response plan(s) within its cyber security plan(s) for its assets containing</p>	<p>to document physical security controls according to Requirement R2, Attachment 1, Section 2. (R2)</p> <p>OR</p> <p>The Responsible Entity documented its cyber security plan(s) for its assets containing low impact BES Cyber Systems, but failed to document electronic access controls according to Requirement R2, Attachment 1, Section 3. (R2)</p> <p>OR</p> <p>The Responsible Entity documented its cyber security plan(s) for electronic access controls but</p>	<p>access controls according to Requirement R2, Attachment 1, Section 3.1. (R2)</p> <p>OR</p> <p>The Responsible Entity documented one or more Cyber Security Incident response plan(s) within its cyber security plan(s) for its assets containing low impact BES Cyber Systems, but failed to test each Cyber Security Incident response plan(s) at least once every 36 calendar months according to Requirement R2, Attachment 1, Section 4. (R2)</p> <p>OR</p> <p>The Responsible Entity documented the determination of</p>	

R #	Time Horizon	VRF	Violation Severity Levels (CIP-003-8)			
			Lower VSL	Moderate VSL	High VSL	Severe VSL
			low impact BES Cyber Systems, but failed to update each Cyber Security Incident response plan(s) within 180 days according to Requirement R2, Attachment 1, Section 4. (R2) OR The Responsible Entity documented its plan(s) for Transient Cyber Assets and Removable Media, but failed to manage its Transient Cyber Asset(s) according to Requirement R2, Attachment 1, Section 5.1. (R2) OR The Responsible Entity documented	failed to implement authentication for all Dial-up Connectivity that provides access to low impact BES Cyber System(s), per Cyber Asset capability according to Requirement R2, Attachment 1, Section 3.2 (R2) OR The Responsible Entity documented one or more incident response plan(s) within its cyber security plan(s) for its assets containing low impact BES Cyber Systems, but failed to include the process for identification, classification, and response to Cyber Security Incidents	whether an identified Cyber Security Incident is a Reportable Cyber Security Incident, but failed to notify the Electricity Information Sharing and Analysis Center (E-ISAC) according to Requirement R2, Attachment 1, Section 4. (R2) OR The Responsible Entity documented its plan(s) for Transient Cyber Assets and Removable Media, but failed to implement mitigation for the introduction of malicious code for Transient Cyber Assets managed by the Responsible Entity according to Requirement R2,	



R #	Time Horizon	VRF	Violation Severity Levels (CIP-003-8)			
			Lower VSL	Moderate VSL	High VSL	Severe VSL
			its plan(s) for Transient Cyber Assets, but failed to document the Removable Media section(s) according to Requirement R2, Attachment 1, Section 5.3. (R2)	according to Requirement R2, Attachment 1, Section 4. (R2)  OR The Responsible Entity documented its cyber security plan(s) for its assets containing low impact BES Cyber Systems, but failed to document the determination of whether an identified Cyber Security Incident is a Reportable Cyber Security Incident and subsequent notification to the Electricity Information Sharing and Analysis Center (E-ISAC) according to Requirement R2,	Attachment 1, Section 5.1. (R2)  OR The Responsible Entity documented its plan(s) for Transient Cyber Assets and Removable Media, but failed to implement mitigation for the introduction of malicious code for Transient Cyber Assets managed by a party other than the Responsible Entity according to Requirement R2, Attachment 1, Section 5.2. (R2)  OR The Responsible Entity documented its plan(s) for Transient Cyber Assets and Removable Media, but failed to implement mitigation for	

R #	Time Horizon	VRF	Violation Severity Levels (CIP-003-8)			
			Lower VSL	Moderate VSL	High VSL	Severe VSL
				<p>Attachment 1, Section 4. (R2)</p> <p>OR</p> <p>The Responsible Entity documented its plan(s) for Transient Cyber Assets and Removable Media, but failed to document mitigation for the introduction of malicious code for Transient Cyber Assets managed by the Responsible Entity according to Requirement R2, Attachment 1, Sections 5.1 and 5.3. (R2)</p> <p>OR</p> <p>The Responsible Entity documented its plan(s) for Transient Cyber</p>	<p>the threat of detected malicious code on the Removable Media prior to connecting Removable Media to a low impact BES Cyber System according to Requirement R2, Attachment 1, Section 5.3. (R2)</p>	

R #	Time Horizon	VRF	Violation Severity Levels (CIP-003-8)			
			Lower VSL	Moderate VSL	High VSL	Severe VSL
				<p>Assets and Removable Media, but failed to document mitigation for the introduction of malicious code for Transient Cyber Assets managed by a party other than the Responsible Entity according to Requirement R2, Attachment 1, Section 5.2. (R2)</p> <p>OR</p> <p>The Responsible Entity documented its plan(s) for Transient Cyber Assets and Removable Media, but failed to implement the Removable Media section(s) according to Requirement R2,</p>		

R #	Time Horizon	VRF	Violation Severity Levels (CIP-003-8)			
			Lower VSL	Moderate VSL	High VSL	Severe VSL
				Attachment 1, Section 5.3. (R2)		
<b>R3</b>	<b>Operations Planning</b>	<b>Medium</b>	The Responsible Entity has identified by name a CIP Senior Manager, but did not document changes to the CIP Senior Manager within 30 calendar days but did document this change in less than 40 calendar days of the change. (R3)	The Responsible Entity has identified by name a CIP Senior Manager, but did not document changes to the CIP Senior Manager within 40 calendar days but did document this change in less than 50 calendar days of the change. (R3)	The Responsible Entity has identified by name a CIP Senior Manager, but did not document changes to the CIP Senior Manager within 50 calendar days but did document this change in less than 60 calendar days of the change. (R3)	The Responsible Entity has not identified, by name, a CIP Senior Manager.  OR The Responsible Entity has identified by name a CIP Senior Manager, but did not document changes to the CIP Senior Manager within 60 calendar days of the change. (R3)
<b>R4</b>	<b>Operations Planning</b>	<b>Lower</b>	The Responsible Entity has identified a delegate by name, title, date of delegation, and specific actions delegated, but did	The Responsible Entity has identified a delegate by name, title, date of delegation, and specific actions delegated, but did	The Responsible Entity has identified a delegate by name, title, date of delegation, and specific actions delegated, but did not document changes to the delegate	The Responsible Entity has used delegated authority for actions where allowed by the CIP Standards, but does not have a process

R #	Time Horizon	VRF	Violation Severity Levels (CIP-003-8)			
			Lower VSL	Moderate VSL	High VSL	Severe VSL
			not document changes to the delegate within 30 calendar days but did document this change in less than 40 calendar days of the change. (R4)	not document changes to the delegate within 40 calendar days but did document this change in less than 50 calendar days of the change. (R4)	within 50 calendar days but did document this change in less than 60 calendar days of the change. (R4)	to delegate actions from the CIP Senior Manager. (R4)  OR The Responsible Entity has identified a delegate by name, title, date of delegation, and specific actions delegated, but did not document changes to the delegate within 60 calendar days of the change. (R4)

**D. Regional Variances**

None.

**E. Interpretations**

None.

**F. Associated Documents**

None.

## Version History

Version	Date	Action	Change Tracking
1	1/16/06	R3.2 — Change “Control Center” to “control center.”	3/24/06
2	9/30/09	Modifications to clarify the requirements and to bring the compliance elements into conformance with the latest guidelines for developing compliance elements of standards.  Removal of reasonable business judgment.  Replaced the RRO with the RE as a responsible entity.  Rewording of Effective Date.  Changed compliance monitor to Compliance Enforcement Authority.	
3	12/16/09	Updated Version Number from -2 to -3  In Requirement 1.6, deleted the sentence pertaining to removing component or system from service in order to perform testing, in response to FERC order issued September 30, 2009.	
3	12/16/09	Approved by the NERC Board of Trustees.	
3	3/31/10	Approved by FERC.	
4	1/24/11	Approved by the NERC Board of Trustees.	
5	11/26/12	Adopted by the NERC Board of Trustees.	Modified to coordinate with other CIP standards and to revise format to use RBS Template.
5	11/22/13	FERC Order issued approving CIP-003-5.	

Version	Date	Action	Change Tracking
6	11/13/14	Adopted by the NERC Board of Trustees.	Addressed two FERC directives from Order No. 791 related to identify, assess, and correct language and communication networks.
6	2/12/15	Adopted by the NERC Board of Trustees.	Replaces the version adopted by the Board on 11/13/2014. Revised version addresses remaining directives from Order No. 791 related to transient devices and low impact BES Cyber Systems.
6	1/21/16	FERC Order issued approving CIP-003-6. Docket No. RM15-14-000	
7	2/9/17	Adopted by the NERC Board of Trustees.	Revised to address FERC Order No. 822 directives regarding (1) the definition of LERC and (2) transient devices.
7	4/19/18	FERC Order issued approving CIP-003-7. Docket No. RM17-11-000	

Version	Date	Action	Change Tracking
8	TBD	FERC Order issued approving CIP-003-7.Docket No. RM17-11-000	



## Attachment 1

### Required Sections for Cyber Security Plan(s) for Assets Containing Low Impact BES Cyber Systems

Responsible Entities shall include each of the sections provided below in the cyber security plan(s) required under Requirement R2.

Responsible Entities with multiple-impact BES Cyber Systems ratings can utilize policies, procedures, and processes for their high or medium impact BES Cyber Systems to fulfill the sections for the development of low impact cyber security plan(s). Each Responsible Entity can develop a cyber security plan(s) either by individual asset or groups of assets.

**Section 1.** Cyber Security Awareness: Each Responsible Entity shall reinforce, at least once every 15 calendar months, cyber security practices (which may include associated physical security practices).

**Section 2.** Physical Security Controls: Each Responsible Entity shall control physical access, based on need as determined by the Responsible Entity, to (1) the asset or the locations of the low impact BES Cyber Systems within the asset, and (2) the Cyber Asset(s), as specified by the Responsible Entity, that provide electronic access control(s) implemented for Section 3.1, if any.

**Section 3.** Electronic Access Controls: For each asset containing low impact BES Cyber System(s) identified pursuant to CIP-002, the Responsible Entity shall implement electronic access controls to:

- 3.1** Permit only necessary inbound and outbound electronic access as determined by the Responsible Entity for any communications that are:
  - i. between a low impact BES Cyber System(s) and a Cyber Asset(s) outside the asset containing low impact BES Cyber System(s);
  - ii. using a routable protocol when entering or leaving the asset containing the low impact BES Cyber System(s); and
  - iii. not used for time-sensitive protection or control functions between intelligent electronic devices (e.g., communications using protocol IEC TR-61850-90-5 R-GOOSE).
- 3.2** Authenticate all Dial-up Connectivity, if any, that provides access to low impact BES Cyber System(s), per Cyber Asset capability.

**Section 4.** Cyber Security Incident Response: Each Responsible Entity shall have one or more Cyber Security Incident response plan(s), either by asset or group of assets, which shall include:

- 4.1** Identification, classification, and response to Cyber Security Incidents;
- 4.2** Determination of whether an identified Cyber Security Incident is a Reportable Cyber Security Incident and subsequent notification to the

Electricity Information Sharing and Analysis Center (E-ISAC), unless prohibited by law;

- 4.3 Identification of the roles and responsibilities for Cyber Security Incident response by groups or individuals;
- 4.4 Incident handling for Cyber Security Incidents;
- 4.5 Testing the Cyber Security Incident response plan(s) at least once every 36 calendar months by: (1) responding to an actual Reportable Cyber Security Incident; (2) using a drill or tabletop exercise of a Reportable Cyber Security Incident; or (3) using an operational exercise of a Reportable Cyber Security Incident; and
- 4.6 Updating the Cyber Security Incident response plan(s), if needed, within 180 calendar days after completion of a Cyber Security Incident response plan(s) test or actual Reportable Cyber Security Incident.

**Section 5. Transient Cyber Asset and Removable Media Malicious Code Risk Mitigation:** Each Responsible Entity shall implement, except under CIP Exceptional Circumstances, one or more plan(s) to achieve the objective of mitigating the risk of the introduction of malicious code to low impact BES Cyber Systems through the use of Transient Cyber Assets or Removable Media. The plan(s) shall include:

- 5.1 For Transient Cyber Asset(s) managed by the Responsible Entity, if any, the use of one or a combination of the following in an ongoing or on-demand manner (per Transient Cyber Asset capability):
  - Antivirus software, including manual or managed updates of signatures or patterns;
  - Application whitelisting; or
  - Other method(s) to mitigate the introduction of malicious code.
- 5.2 For Transient Cyber Asset(s) managed by a party other than the Responsible Entity, if any:
  - 5.2.1 Use one or a combination of the following prior to connecting the Transient Cyber Asset to a low impact BES Cyber System (per Transient Cyber Asset capability):
    - Review of antivirus update level;
    - Review of antivirus update process used by the party;
    - Review of application whitelisting used by the party;
    - Review use of live operating system and software executable only from read-only media;
    - Review of system hardening used by the party; or

- Other method(s) to mitigate the introduction of malicious code.
- 5.2.2** For any method used pursuant to 5.2.1, Responsible Entities shall determine whether any additional mitigation actions are necessary and implement such actions prior to connecting the Transient Cyber Asset.
- 5.3** For Removable Media, the use of each of the following:
- 5.3.1** Method(s) to detect malicious code on Removable Media using a Cyber Asset other than a BES Cyber System; and
  - 5.3.2** Mitigation of the threat of detected malicious code on the Removable Media prior to connecting Removable Media to a low impact BES Cyber System.

## Attachment 2

### Examples of Evidence for Cyber Security Plan(s) for Assets Containing Low Impact BES Cyber Systems

**Section 1. Cyber Security Awareness:** An example of evidence for Section 1 may include, but is not limited to, documentation that the reinforcement of cyber security practices occurred at least once every 15 calendar months. The evidence could be documentation through one or more of the following methods:

- Direct communications (for example, e-mails, memos, or computer-based training);
- Indirect communications (for example, posters, intranet, or brochures); or
- Management support and reinforcement (for example, presentations or meetings).

**Section 2. Physical Security Controls:** Examples of evidence for Section 2 may include, but are not limited to:

- Documentation of the selected access control(s) (e.g., card key, locks, perimeter controls), monitoring controls (e.g., alarm systems, human observation), or other operational, procedural, or technical physical security controls that control physical access to both:
  - a. The asset, if any, or the locations of the low impact BES Cyber Systems within the asset; and
  - b. The Cyber Asset(s) specified by the Responsible Entity that provide(s) electronic access controls implemented for Attachment 1, Section 3.1, if any.

**Section 3. Electronic Access Controls:** Examples of evidence for Section 3 may include, but are not limited to:

1. Documentation showing that at each asset or group of assets containing low impact BES Cyber Systems, routable communication between a low impact BES Cyber System(s) and a Cyber Asset(s) outside the asset is restricted by electronic access controls to permit only inbound and outbound electronic access that the Responsible Entity deems necessary, except where an entity provides rationale that communication is used for time-sensitive protection or control functions between intelligent electronic devices. Examples of such documentation may include, but are not limited to representative diagrams that illustrate control of inbound and outbound communication(s) between the low impact BES Cyber System(s) and a Cyber Asset(s) outside the asset containing low impact BES Cyber System(s) or lists of implemented electronic access controls (e.g., access control lists restricting IP addresses, ports, or services; implementing unidirectional gateways).

2. Documentation of authentication for Dial-up Connectivity (e.g., dial out only to a preprogrammed number to deliver data, dial-back modems, modems that must be remotely controlled by the control center or control room, or access control on the BES Cyber System).

**Section 4. Cyber Security Incident Response:** An example of evidence for Section 4 may include, but is not limited to, dated documentation, such as policies, procedures, or process documents of one or more Cyber Security Incident response plan(s) developed either by asset or group of assets that include the following processes:

1. to identify, classify, and respond to Cyber Security Incidents; to determine whether an identified Cyber Security Incident is a Reportable Cyber Security Incident and for notifying the Electricity Information Sharing and Analysis Center (E-ISAC);
2. to identify and document the roles and responsibilities for Cyber Security Incident response by groups or individuals (e.g., initiating, documenting, monitoring, reporting, etc.);
3. for incident handling of a Cyber Security Incident (e.g., containment, eradication, or recovery/incident resolution);
4. for testing the plan(s) along with the dated documentation that a test has been completed at least once every 36 calendar months; and
5. to update, as needed, Cyber Security Incident response plan(s) within 180 calendar days after completion of a test or actual Reportable Cyber Security Incident.

**Section 5. Transient Cyber Asset and Removable Media Malicious Code Risk Mitigation:**

1. Examples of evidence for Section 5.1 may include, but are not limited to, documentation of the method(s) used to mitigate the introduction of malicious code such as antivirus software and processes for managing signature or pattern updates, application whitelisting practices, processes to restrict communication, or other method(s) to mitigate the introduction of malicious code. If a Transient Cyber Asset does not have the capability to use method(s) that mitigate the introduction of malicious code, evidence may include documentation by the vendor or Responsible Entity that identifies that the Transient Cyber Asset does not have the capability.
2. Examples of evidence for Section 5.2.1 may include, but are not limited to, documentation from change management systems, electronic mail or procedures that document a review of the installed antivirus update level; memoranda, electronic mail, system documentation, policies or contracts from the party other than the Responsible Entity that identify the antivirus update process, the use of application whitelisting, use of live operating systems or system hardening performed by the party other than the Responsible Entity; evidence from change management systems, electronic mail or contracts that

identifies the Responsible Entity's acceptance that the practices of the party other than the Responsible Entity are acceptable; or documentation of other method(s) to mitigate malicious code for Transient Cyber Asset(s) managed by a party other than the Responsible Entity. If a Transient Cyber Asset does not have the capability to use method(s) that mitigate the introduction of malicious code, evidence may include documentation by the Responsible Entity or the party other than the Responsible Entity that identifies that the Transient Cyber Asset does not have the capability.

Examples of evidence for Attachment 1, Section 5.2.2 may include, but are not limited to, documentation from change management systems, electronic mail, or contracts that identifies a review to determine whether additional mitigation is necessary and has been implemented prior to connecting the Transient Cyber Asset managed by a party other than the Responsible Entity.

3. Examples of evidence for Section 5.3.1 may include, but are not limited to, documented process(es) of the method(s) used to detect malicious code such as results of scan settings for Removable Media, or implementation of on-demand scanning. Examples of evidence for Section 5.3.2 may include, but are not limited to, documented process(es) for the method(s) used for mitigating the threat of detected malicious code on Removable Media, such as logs from the method(s) used to detect malicious code that show the results of scanning and the mitigation of detected malicious code on Removable Media or documented confirmation by the entity that the Removable Media was deemed to be free of malicious code.

## Guidelines and Technical Basis

### Section 4 – Scope of Applicability of the CIP Cyber Security Standards

Section “4. Applicability” of the standards provides important information for Responsible Entities to determine the scope of the applicability of the CIP Cyber Security Requirements.

Section “4.1. Functional Entities” is a list of NERC functional entities to which the standard applies. If the entity is registered as one or more of the functional entities listed in Section 4.1, then the NERC CIP Cyber Security Standards apply. Note that there is a qualification in Section 4.1 that restricts the applicability in the case of Distribution Providers to only those that own certain types of systems and equipment listed in 4.2.

Section “4.2. Facilities” defines the scope of the Facilities, systems, and equipment owned by the Responsible Entity, as qualified in Section 4.1, that is subject to the requirements of the standard. In addition to the set of BES Facilities, Control Centers, and other systems and equipment, the list includes the set of systems and equipment owned by Distribution Providers. While the NERC Glossary term “Facilities” already includes the BES characteristic, the additional use of the term BES here is meant to reinforce the scope of applicability of these Facilities where it is used, especially in this applicability scoping section. This in effect sets the scope of Facilities, systems, and equipment that is subject to the standards.

#### Requirement R1:

In developing policies in compliance with Requirement R1, the number of policies and their content should be guided by a Responsible Entity's management structure and operating conditions. Policies might be included as part of a general information security program for the entire organization, or as components of specific programs. The Responsible Entity has the flexibility to develop a single comprehensive cyber security policy covering the required topics, or it may choose to develop a single high-level umbrella policy and provide additional policy detail in lower level documents in its documentation hierarchy. In the case of a high-level umbrella policy, the Responsible Entity would be expected to provide the high-level policy as well as the additional documentation in order to demonstrate compliance with CIP-003-8, Requirement R1.

If a Responsible Entity has any high or medium impact BES Cyber Systems, the one or more cyber security policies must cover the nine subject matter areas required by CIP-003-8, Requirement R1, Part 1.1. If a Responsible Entity has identified from CIP-002 any assets containing low impact BES Cyber Systems, the one or more cyber security policies must cover the six subject matter areas required by Requirement R1, Part 1.2.

Responsible Entities that have multiple-impact rated BES Cyber Systems are not required to create separate cyber security policies for high, medium, or low impact BES Cyber Systems. The Responsible Entities have the flexibility to develop policies that cover all three impact ratings.

Implementation of the cyber security policy is not specifically included in CIP-003-8, Requirement R1 as it is envisioned that the implementation of this policy is evidenced through successful implementation of CIP-003 through CIP-011. However, Responsible Entities are encouraged not to limit the scope of their cyber security policies to only those requirements in NERC cyber security Reliability Standards, but to develop a holistic cyber security policy

appropriate for its organization. Elements of a policy that extend beyond the scope of NERC's cyber security Reliability Standards will not be considered candidates for potential violations although they will help demonstrate the organization's internal culture of compliance and posture towards cyber security.

For Part 1.1, the Responsible Entity may consider the following for each of the required topics in its one or more cyber security policies for medium and high impact BES Cyber Systems, if any:

### 1.1.1 Personnel and training (CIP-004)

- Organization position on acceptable background investigations
- Identification of possible disciplinary action for violating this policy
- Account management

### 1.1.2 Electronic Security Perimeters (CIP-005) including Interactive Remote Access

- Organization stance on use of wireless networks
- Identification of acceptable authentication methods
- Identification of trusted and untrusted resources
- Monitoring and logging of ingress and egress at Electronic Access Points
- Maintaining up-to-date anti-malware software before initiating Interactive Remote Access
- Maintaining up-to-date patch levels for operating systems and applications used to initiate Interactive Remote Access
- Disabling VPN "split-tunneling" or "dual-homed" workstations before initiating Interactive Remote Access
- For vendors, contractors, or consultants: include language in contracts that requires adherence to the Responsible Entity's Interactive Remote Access controls

### 1.1.3 Physical security of BES Cyber Systems (CIP-006)

- Strategy for protecting Cyber Assets from unauthorized physical access
- Acceptable physical access control methods
- Monitoring and logging of physical ingress

### 1.1.4 System security management (CIP-007)

- Strategies for system hardening
- Acceptable methods of authentication and access control
- Password policies including length, complexity, enforcement, prevention of brute force attempts
- Monitoring and logging of BES Cyber Systems



- 1.1.5 Incident reporting and response planning (CIP-008)
  - Recognition of Cyber Security Incidents
  - Appropriate notifications upon discovery of an incident
  - Obligations to report Cyber Security Incidents
- 1.1.6 Recovery plans for BES Cyber Systems (CIP-009)
  - Availability of spare components
  - Availability of system backups
- 1.1.7 Configuration change management and vulnerability assessments (CIP-010)
  - Initiation of change requests
  - Approval of changes
  - Break-fix processes
- 1.1.8 Information protection (CIP-011)
  - Information access control methods
  - Notification of unauthorized information disclosure
  - Information access on a need-to-know basis
- 1.1.9 Declaring and responding to CIP Exceptional Circumstances
  - Processes to invoke special procedures in the event of a CIP Exceptional Circumstance
  - Processes to allow for exceptions to policy that do not violate CIP requirements

For Part 1.2, the Responsible Entity may consider the following for each of the required topics in its one or more cyber security policies for assets containing low impact BES Cyber Systems, if any:

- 1.2.1 Cyber security awareness
  - Method(s) for delivery of security awareness
  - Identification of groups to receive cyber security awareness
- 1.2.2 Physical security controls
  - Acceptable approach(es) for selection of physical security control(s)
- 1.2.3 Electronic access controls
  - Acceptable approach(es) for selection of electronic access control(s)
- 1.2.4 Cyber Security Incident response
  - Recognition of Cyber Security Incidents

- Appropriate notifications upon discovery of an incident
- Obligations to report Cyber Security Incidents

### 1.2.5 Transient Cyber Assets and Removable Media Malicious Code Risk Mitigation

- Acceptable use of Transient Cyber Asset(s) and Removable Media
- Method(s) to mitigate the risk of the introduction of malicious code to low impact BES Cyber Systems from Transient Cyber Assets and Removable Media
- Method(s) to request Transient Cyber Asset and Removable Media

### 1.2.6 Declaring and responding to CIP Exceptional Circumstances

- Process(es) to declare a CIP Exceptional Circumstance
- Process(es) to respond to a declared CIP Exceptional Circumstance

Requirements relating to exceptions to a Responsible Entity's security policies were removed because it is a general management issue that is not within the scope of a reliability requirement. It is an internal policy requirement and not a reliability requirement. However, Responsible Entities are encouraged to continue this practice as a component of their cyber security policies.

In this and all subsequent required approvals in the NERC CIP Reliability Standards, the Responsible Entity may elect to use hardcopy or electronic approvals to the extent that there is sufficient evidence to ensure the authenticity of the approving party.

#### **Requirement R2:**

The intent of Requirement R2 is for each Responsible Entity to create, document, and implement one or more cyber security plan(s) that address the security objective for the protection of low impact BES Cyber Systems. The required protections are designed to be part of a program that covers the low impact BES Cyber Systems collectively at an asset level (based on the list of assets containing low impact BES Cyber Systems identified in CIP-002), but not at an individual device or system level.

**Requirement R2, Attachment 1**

As noted, Attachment 1 contains the sections that must be included in the cyber security plan(s). The intent is to allow entities that have a combination of high, medium, and low impact BES Cyber Systems the flexibility to choose, if desired, to cover their low impact BES Cyber Systems (or any subset) under their programs used for the high or medium impact BES Cyber Systems rather than maintain two separate programs. The purpose of the cyber security plan(s) in Requirement R2 is for Responsible Entities to use the cyber security plan(s) as a means of documenting their approaches to meeting the subject matter areas. The cyber security plan(s) can be used to reference other policies and procedures that demonstrate “how” the Responsible Entity is meeting each of the subject matter areas, or Responsible Entities can develop comprehensive cyber security plan(s) that contain all of the detailed implementation content solely within the cyber security plan itself. To meet the obligation for the cyber security plan, the expectation is that the cyber security plan contains or references sufficient details to address the implementation of each of the required subject matters areas.

Guidance for each of the subject matter areas of Attachment 1 is provided below.

**Requirement R2, Attachment 1, Section 1 – Cyber Security Awareness**

The intent of the cyber security awareness program is for entities to reinforce good cyber security practices with their personnel at least once every 15 calendar months. The entity has the discretion to determine the topics to be addressed and the manner in which it will communicate these topics. As evidence of compliance, the Responsible Entity should be able to produce the awareness material that was delivered according to the delivery method(s) (e.g., posters, emails, or topics at staff meetings, etc.). The standard drafting team does not intend for Responsible Entities to be required to maintain lists of recipients and track the reception of the awareness material by personnel.

Although the focus of the awareness is cyber security, it does not mean that only technology-related topics can be included in the program. Appropriate physical security topics (e.g., tailgating awareness and protection of badges for physical security, or “If you see something, say something” campaigns, etc.) are valid for cyber security awareness. The intent is to cover topics concerning any aspect of the protection of BES Cyber Systems.

**Requirement R2, Attachment 1, Section 2 – Physical Security Controls**

The Responsible Entity must document and implement methods to control physical access to (1) the asset or the locations of low impact BES Cyber Systems within the asset, and (2) Cyber Assets that implement the electronic access control(s) specified by the Responsible Entity in Attachment 1, Section 3.1, if any. If these Cyber Assets implementing the electronic access controls are located within the same asset as the low impact BES Cyber Asset(s) and inherit the same physical access controls and the same need as outlined in Section 2, this may be noted by the Responsible Entity in either its policies or cyber security plan(s) to avoid duplicate documentation of the same controls.

The Responsible Entity has the flexibility to select the methods used to meet the objective of controlling physical access to (1) the asset(s) containing low impact BES Cyber System(s) or the low impact BES Cyber Systems themselves and (2) the electronic access control Cyber Assets specified by the Responsible Entity, if any. The Responsible Entity may use one or a

combination of physical access controls, monitoring controls, or other operational, procedural, or technical physical security controls. Entities may use perimeter controls (e.g., fences with locked gates, guards, or site access policies, etc.) or more granular areas of physical access control in areas where low impact BES Cyber Systems are located, such as control rooms or control houses.

The security objective is to control the physical access based on need as determined by the Responsible Entity. The need for physical access can be documented at the policy level. The standard drafting team did not intend to obligate an entity to specify a need for each physical access or authorization of an individual for physical access.

Monitoring as a physical security control can be used as a complement or an alternative to physical access control. Examples of monitoring controls include, but are not limited to: (1) alarm systems to detect motion or entry into a controlled area, or (2) human observation of a controlled area. Monitoring does not necessarily require logging and maintaining logs but could include monitoring that physical access has occurred or been attempted (e.g., door alarm, or human observation, etc.). The standard drafting team's intent is that the monitoring does not need to be per low impact BES Cyber System but should be at the appropriate level to meet the security objective of controlling physical access.

User authorization programs and lists of authorized users for physical access are not required although they are an option to meet the security objective.

### **Requirement R2, Attachment 1, Section 3 – Electronic Access Controls**

Section 3 requires the establishment of electronic access controls for assets containing low impact BES Cyber Systems when there is routable protocol communication or Dial-up Connectivity between Cyber Asset(s) outside of the asset containing the low impact BES Cyber System(s) and the low impact BES Cyber System(s) within such asset. The establishment of electronic access controls is intended to reduce the risks associated with uncontrolled communication using routable protocols or Dial-up Connectivity.

When implementing Attachment 1, Section 3.1, Responsible Entities should note that electronic access controls to permit only necessary inbound and outbound electronic access are required for communications when those communications meet all three of the criteria identified in Attachment 1, Section 3.1. The Responsible Entity should evaluate the communications and when all three criteria are met, the Responsible Entity must document and implement electronic access control(s).

When identifying electronic access controls, Responsible Entities are provided flexibility in the selection of the electronic access controls that meet their operational needs while meeting the security objective of allowing only necessary inbound and outbound electronic access to low impact BES Cyber Systems that use routable protocols between a low impact BES Cyber System(s) and Cyber Asset(s) outside the asset.

In essence, the intent is for Responsible Entities to determine whether there is communication between a low impact BES Cyber System(s) and a Cyber Asset(s) outside the asset containing low impact BES Cyber System(s) that uses a routable protocol when entering or leaving the asset or Dial-up Connectivity to the low impact BES Cyber System(s). Where such

communication is present, Responsible Entities should document and implement electronic access control(s). Where routable protocol communication for time-sensitive protection or control functions between intelligent electronic devices that meets the exclusion language is present, Responsible Entities should document that communication, but are not required to establish any specific electronic access controls.

The inputs to this requirement are the assets identified in CIP-002 as containing low impact BES Cyber System(s); therefore, the determination of routable protocol communications or Dial-up Connectivity is an attribute of the asset. However, it is not intended for communication that provides no access to or from the low impact BES Cyber System(s), but happens to be located at the asset with the low impact BES Cyber System(s), to be evaluated for electronic access controls.

### Electronic Access Control Exclusion

In order to avoid future technology issues, the obligations for electronic access controls exclude communications between intelligent electronic devices that use routable communication protocols for time-sensitive protection or control functions, such as IEC TR-61850-90-5 R-GOOSE messaging. Time-sensitive in this context generally means functions that would be negatively impacted by the latency introduced in the communications by the required electronic access controls. This time-sensitivity exclusion does not apply to SCADA communications which typically operate on scan rates of 2 seconds or greater. While technically time-sensitive, SCADA communications over routable protocols can withstand the delay introduced by electronic access controls. Examples of excluded time-sensitive communications are those communications which may necessitate the tripping of a breaker within a few cycles. A Responsible Entity using this technology is not expected to implement the electronic access controls noted herein. This exception was included so as not to inhibit the functionality of the time-sensitive characteristics related to this technology and not to preclude the use of such time-sensitive reliability enhancing functions if they use a routable protocol in the future.

### **Considerations for Determining Routable Protocol Communications**

To determine whether electronic access controls need to be implemented, the Responsible Entity has to determine whether there is communication between a low impact BES Cyber System(s) and a Cyber Asset(s) outside the asset containing the low impact BES Cyber System(s) that uses a routable protocol when entering or leaving the asset.

When determining whether a routable protocol is entering or leaving the asset containing the low impact BES Cyber System(s), Responsible Entities have flexibility in identifying an approach. One approach is for Responsible Entities to identify an “electronic boundary” associated with the asset containing low impact BES Cyber System(s). This is not an Electronic Security Perimeter *per se*, but a demarcation that demonstrates the routable protocol communication entering or leaving the asset between a low impact BES Cyber System and Cyber Asset(s) outside the asset to then have electronic access controls implemented. This electronic boundary may vary by asset type (Control Center, substation, generation resource) and the specific configuration of the asset. If this approach is used, the intent is for the Responsible Entity to define the electronic boundary such that the low impact BES Cyber System(s) located

at the asset are contained within the “electronic boundary.” This is strictly for determining which routable protocol communications and networks are internal or inside or local to the asset and which are external to or outside the asset.

Alternatively, the Responsible Entity may find the concepts of what is inside and outside to be intuitively obvious for a Cyber Asset(s) outside the asset containing low impact BES Cyber System(s) communicating to a low impact BES Cyber System(s) inside the asset. This may be the case when a low impact BES Cyber System(s) is communicating with a Cyber Asset many miles away and a clear and unambiguous demarcation exists. In this case, a Responsible Entity may decide not to identify an “electronic boundary,” but rather to simply leverage the unambiguous asset demarcation to ensure that the electronic access controls are placed between the low impact BES Cyber System(s) and the Cyber Asset(s) outside the asset.

### **Determining Electronic Access Controls**

Once a Responsible Entity has determined that there is routable communication between a low impact BES Cyber System(s) and a Cyber Asset(s) outside the asset containing the low impact BES Cyber System(s) that uses a routable protocol when entering or leaving the asset containing the low impact BES Cyber System(s), the intent is for the Responsible Entity to document and implement its chosen electronic access control(s). The control(s) are intended to allow only “necessary” inbound and outbound electronic access as determined by the Responsible Entity. However the Responsible Entity chooses to document the inbound and outbound access permissions and the need, the intent is that the Responsible Entity is able to explain the reasons for the electronic access permitted. The reasoning for “necessary” inbound and outbound electronic access controls may be documented within the Responsible Entity’s cyber security plan(s), within a comment on an access control list, a database, spreadsheet or other policies or procedures associated with the electronic access controls.

### **Concept Diagrams**

The diagrams on the following pages are provided as examples to illustrate various electronic access controls at a conceptual level. Regardless of the concepts or configurations chosen by the Responsible Entity, the intent is to achieve the security objective of permitting only necessary inbound and outbound electronic access for communication between low impact BES Cyber Systems and Cyber Asset(s) outside the asset containing the low impact BES Cyber System(s) using a routable protocol when entering or leaving the asset.

#### **NOTE:**

- This is not an exhaustive list of applicable concepts.
- The same legend is used in each diagram; however, the diagram may not contain all of the articles represented in the legend.

**Reference Model 1 – Host-based Inbound & Outbound Access Permissions**

The Responsible Entity may choose to utilize a host-based firewall technology on the low impact BES Cyber System(s) itself that manages the inbound and outbound electronic access permissions so that only necessary inbound and outbound electronic access is allowed between the low impact BES Cyber System(s) and the Cyber Asset(s) outside the asset containing the low impact BES Cyber System(s). When permitting the inbound and outbound electronic access permissions using access control lists, the Responsible Entity could restrict communication(s) using source and destination addresses or ranges of addresses. Responsible Entities could also restrict communication(s) using ports or services based on the capability of the electronic access control, the low impact BES Cyber System(s), or the application(s).

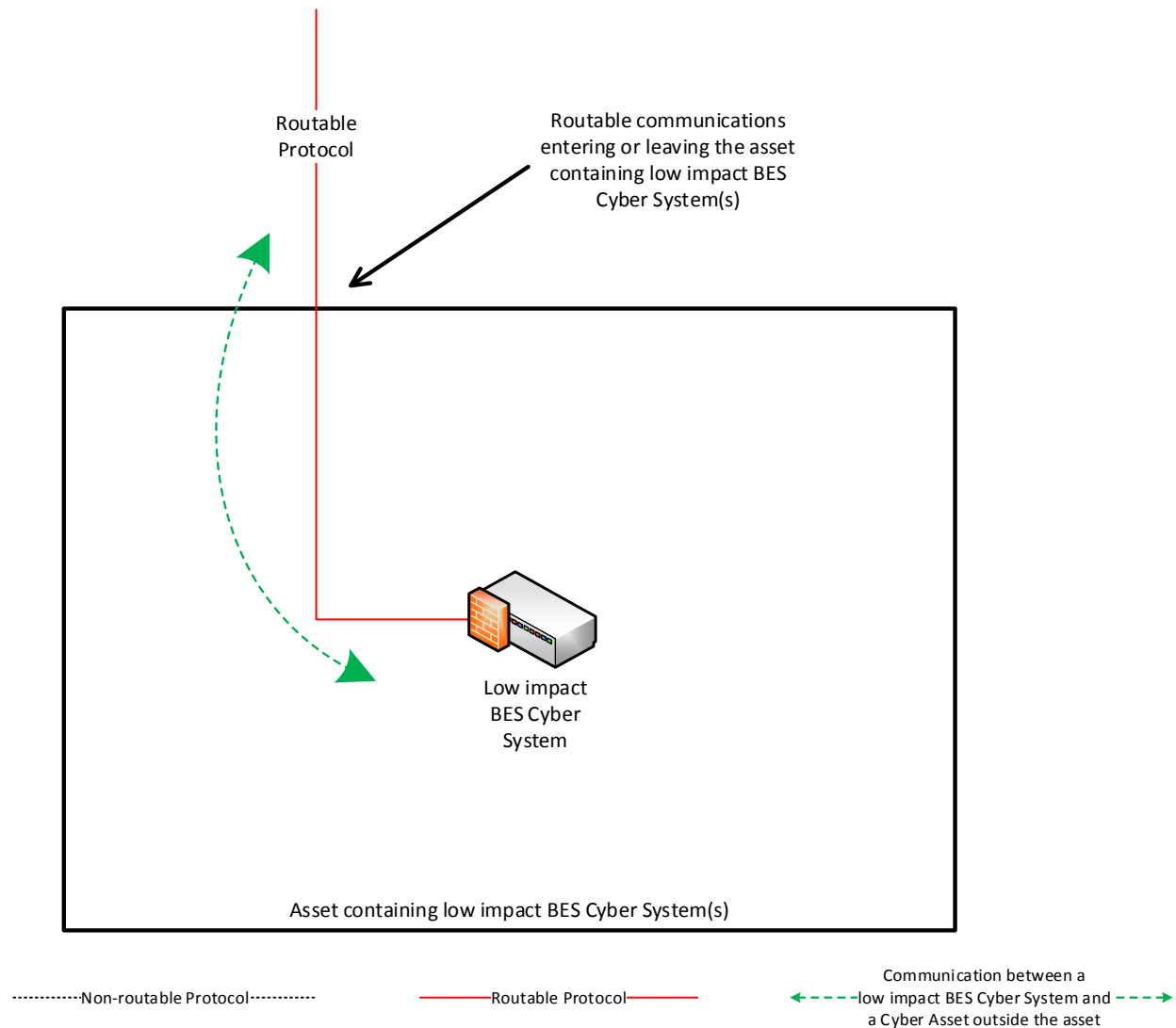

*Reference Model 1*

**Reference Model 2 – Network-based Inbound & Outbound Access Permissions**

The Responsible Entity may choose to use a security device that permits only necessary inbound and outbound electronic access to the low impact BES Cyber System(s) within the asset containing the low impact BES Cyber System(s). In this example, two low impact BES Cyber Systems are accessed using the routable protocol that is entering or leaving the asset containing the low impact BES Cyber System(s). The IP/Serial converter is continuing the same communications session from the Cyber Asset(s) that are outside the asset to the low impact BES Cyber System(s). The security device provides the electronic access controls to permit only necessary inbound and outbound routable protocol access to the low impact BES Cyber System(s). When permitting the inbound and outbound electronic access permissions using access control lists, the Responsible Entity could restrict communication(s) using source and destination addresses or ranges of addresses. Responsible Entities could also restrict communication(s) using ports or services based on the capability of the electronic access control, the low impact BES Cyber System(s), or the application(s).

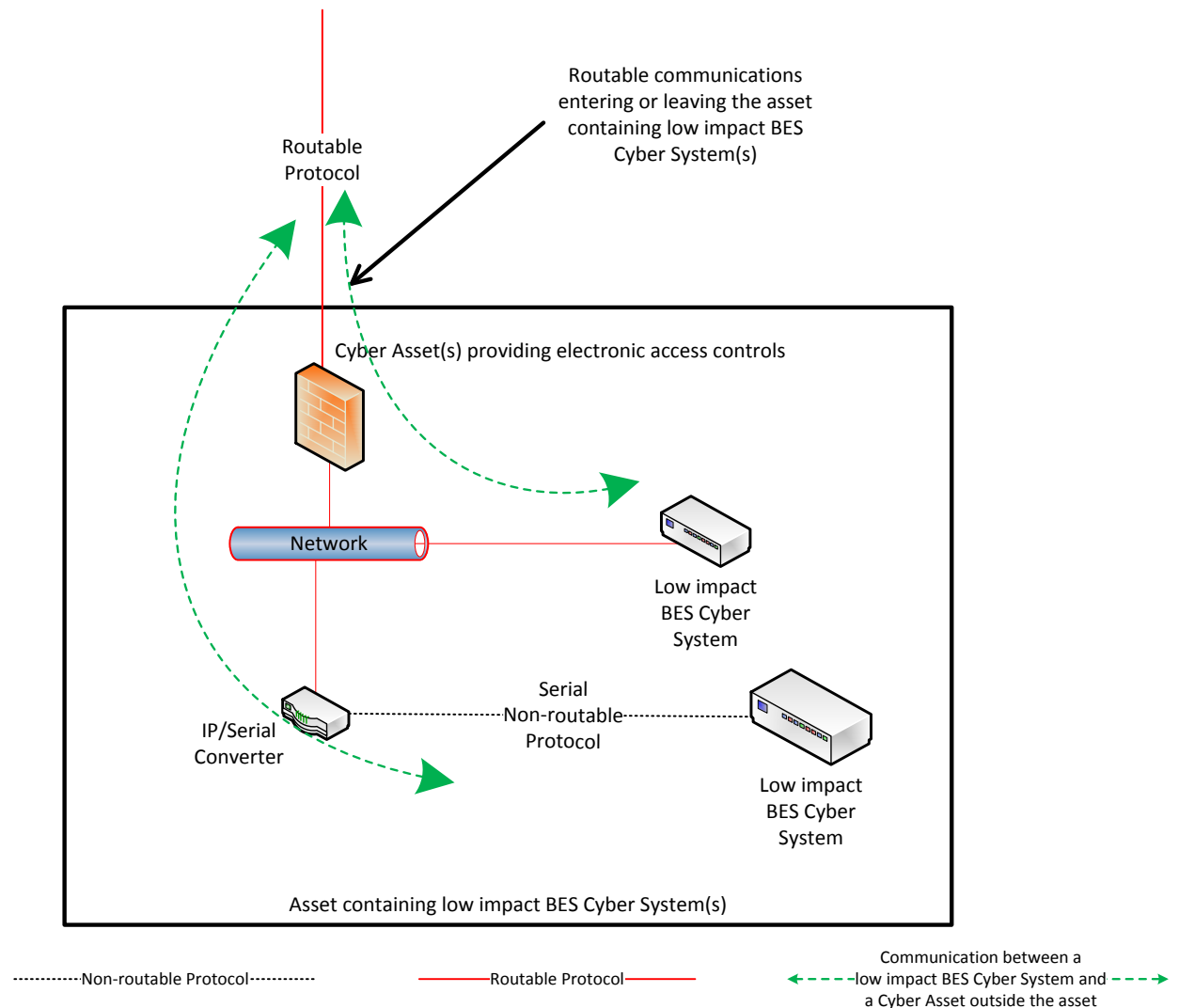

*Reference Model 2*



### Reference Model 3 – Centralized Network-based Inbound & Outbound Access Permissions

The Responsible Entity may choose to utilize a security device at a centralized location that may or may not be at another asset containing low impact BES Cyber System(s). The electronic access control(s) do not necessarily have to reside inside the asset containing the low impact BES Cyber System(s). A security device is in place at “Location X” to act as the electronic access control and permit only necessary inbound and outbound routable protocol access between the low impact BES Cyber System(s) and the Cyber Asset(s) outside each asset containing low impact BES Cyber System(s). Care should be taken that electronic access to or between each asset is through the Cyber Asset(s) determined by the Responsible Entity to be performing electronic access controls at the centralized location. When permitting the inbound and outbound electronic access permissions using access control lists, the Responsible Entity could restrict communication(s) using source and destination addresses or ranges of addresses. Responsible Entities could also restrict communication(s) using ports or services based on the capability of the electronic access control, the low impact BES Cyber System(s), or the application(s).

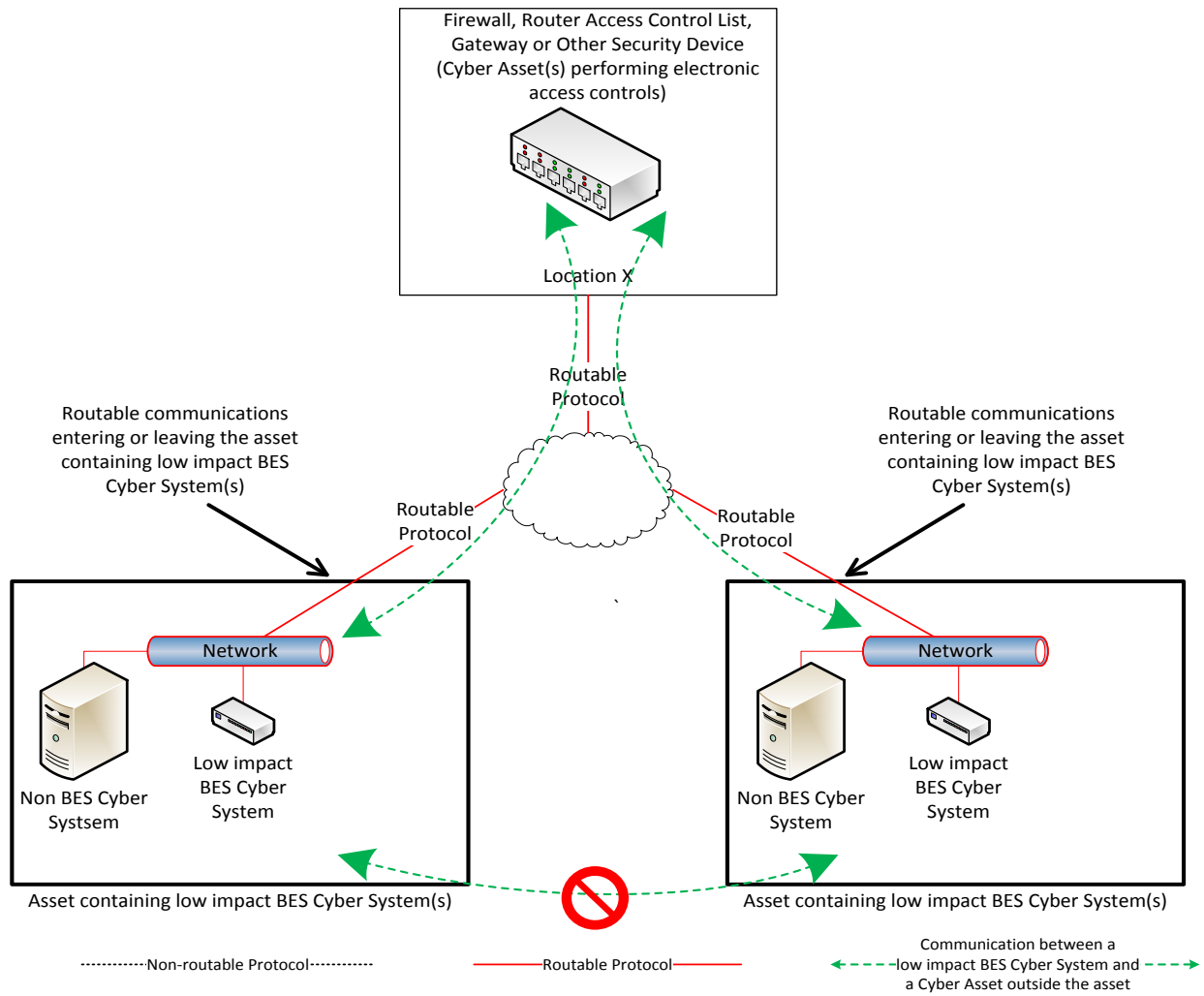

Reference Model 3

### Reference Model 4 – Uni-directional Gateway

The Responsible Entity may choose to utilize a uni-directional gateway as the electronic access control. The low impact BES Cyber System(s) is not accessible (data cannot flow into the low impact BES Cyber System) using the routable protocol entering the asset due to the implementation of a “one-way” (uni-directional) path for data to flow. The uni-directional gateway is configured to permit only the necessary outbound communications using the routable protocol communication leaving the asset.

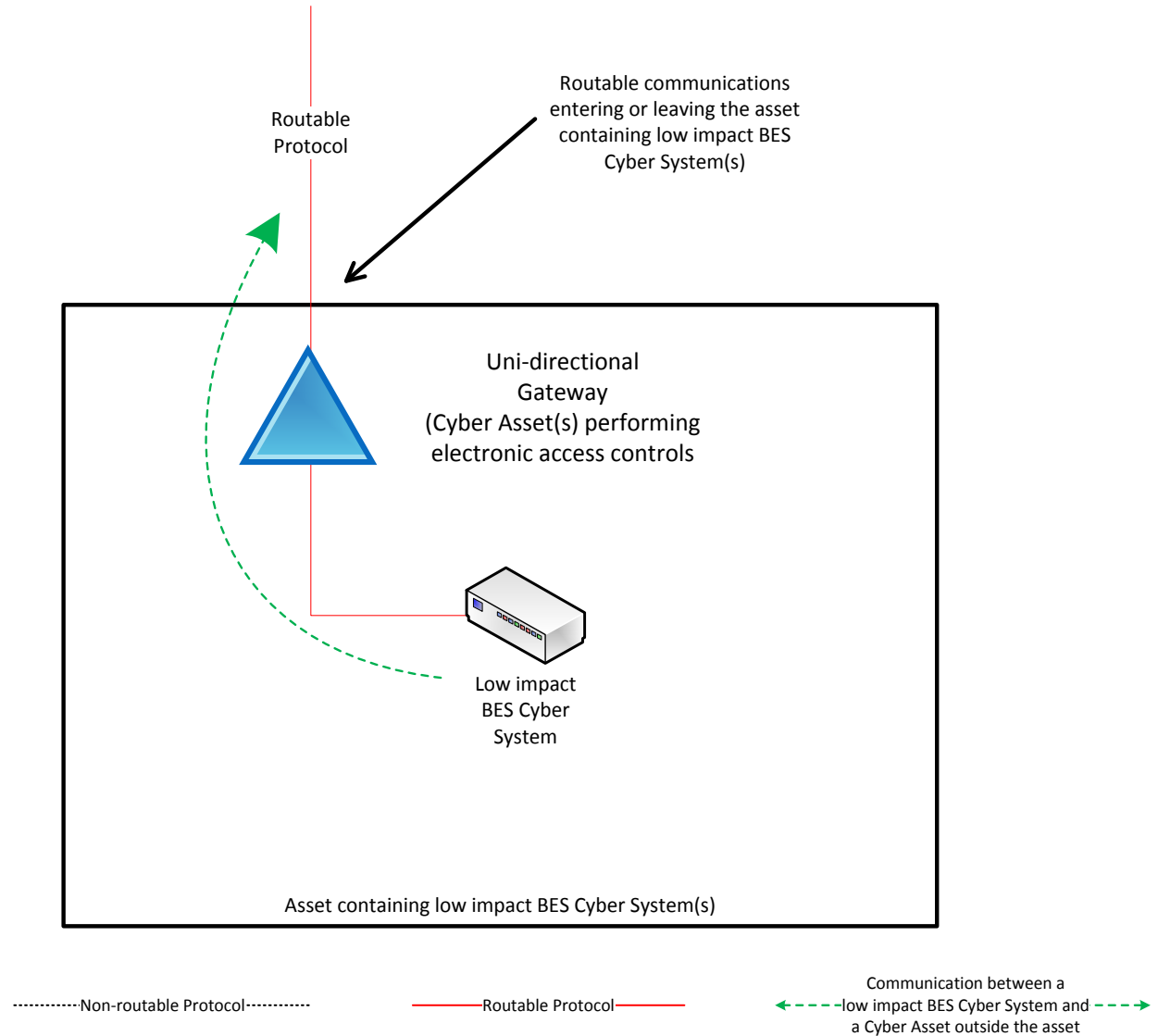

Reference Model 4

### Reference Model 5 – User Authentication

This reference model demonstrates that Responsible Entities have flexibility in choosing electronic access controls so long as the security objective of the requirement is met. The Responsible Entity may choose to utilize a non-BES Cyber Asset located at the asset containing the low impact BES Cyber System that requires authentication for communication from the Cyber Asset(s) outside the asset. This non-BES Cyber System performing the authentication permits only authenticated communication to connect to the low impact BES Cyber System(s), meeting the first half of the security objective to permit only necessary inbound electronic access. Additionally, the non-BES Cyber System performing authentication is configured such that it permits only necessary outbound communication meeting the second half of the security objective. Often, the outbound communications would be controlled in this network architecture by permitting no communication to be initiated from the low impact BES Cyber System. This configuration may be beneficial when the only communication to a device is for user-initiated interactive access.

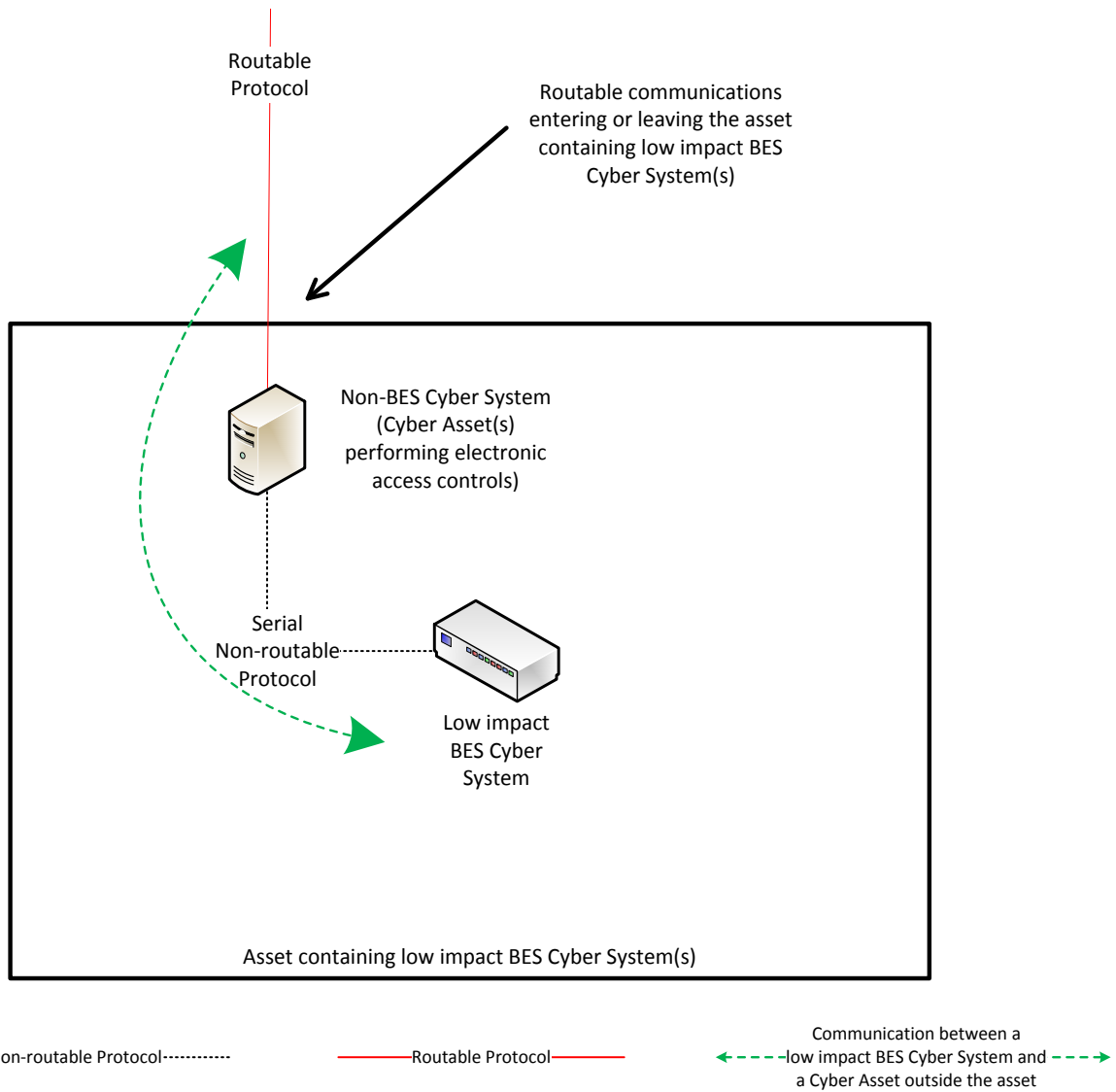

Reference Model 5

### Reference Model 6 – Indirect Access

In implementing its electronic access controls, the Responsible Entity may identify that it has indirect access between the low impact BES Cyber System and a Cyber Asset outside the asset containing the low impact BES Cyber System through a non-BES Cyber Asset located within the asset. This indirect access meets the criteria of having communication between the low impact BES Cyber System and a Cyber Asset outside the asset containing the low impact BES Cyber System. In this reference model, it is intended that the Responsible Entity implement electronic access controls that permit only necessary inbound and outbound electronic access to the low impact BES Cyber System. Consistent with the other reference models provided, the electronic access in this reference model is controlled using the security device that is restricting the communication that is entering or leaving the asset.

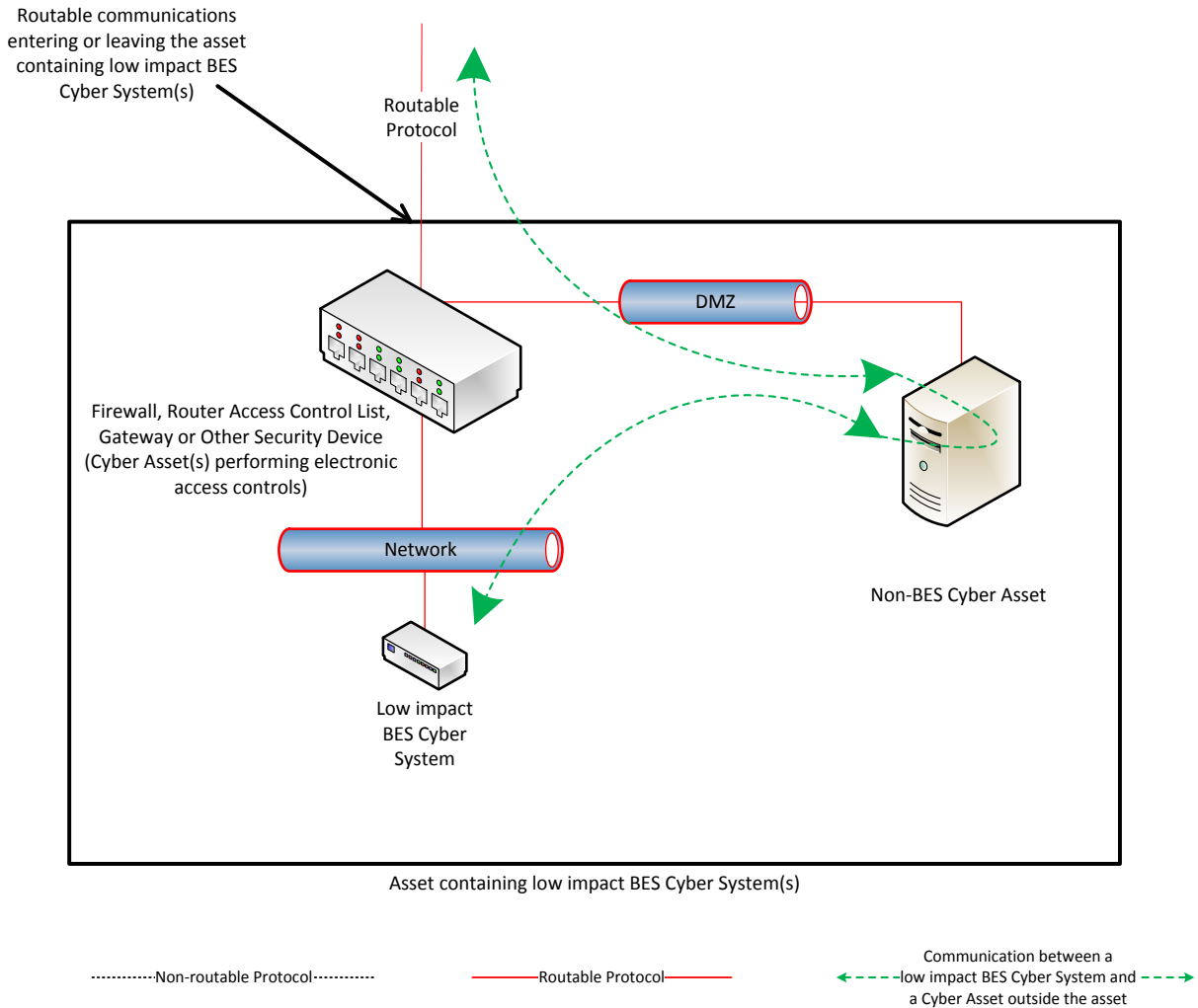

Reference Model 6

### Reference Model 7 – Electronic Access Controls at assets containing low impact BES Cyber Systems and ERC

In this reference model, there is both a routable protocol entering and leaving the asset containing the low impact BES Cyber System(s) that is used by Cyber Asset(s) outside the asset and External Routable Connectivity because there is at least one medium impact BES Cyber System and one low impact BES Cyber System within the asset using the routable protocol communications. The Responsible Entity may choose to leverage an interface on the medium impact Electronic Access Control or Monitoring Systems (EACMS) to provide electronic access controls for purposes of CIP-003. The EACMS is therefore performing multiple functions – as a medium impact EACMS and as implementing electronic access controls for an asset containing low impact BES Cyber Systems.

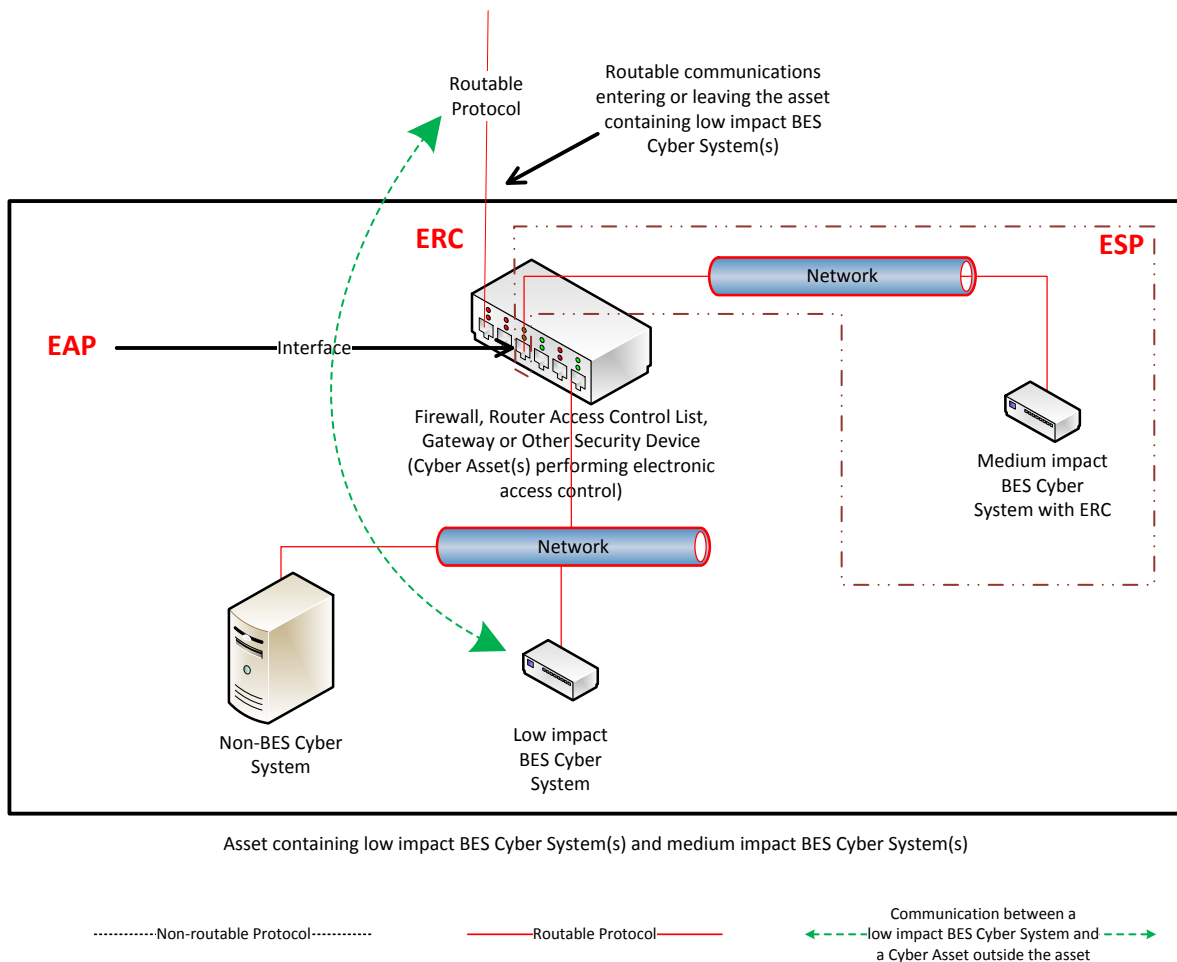

Reference Model 7

**Reference Model 8 – Physical Isolation and Serial Non-routable Communications – No Electronic Access Controls Required**

In this reference model, the criteria from Attachment 1, Section 3.1 requiring the implementation of electronic access controls are not met. This reference model demonstrates three concepts:

- 1) The physical isolation of the low impact BES Cyber System(s) from the routable protocol communication entering or leaving the asset containing the low impact BES Cyber System(s), commonly referred to as an 'air gap', mitigates the need to implement the required electronic access controls;
- 2) The communication to the low impact BES Cyber System from a Cyber Asset outside the asset containing the low impact BES Cyber System(s) using only a serial non-routable protocol where such communication is entering or leaving the asset mitigates the need to implement the required electronic access controls.
- 3) The routable protocol communication between the low impact BES Cyber System(s) and other Cyber Asset(s), such as the second low impact BES Cyber System depicted, may exist without needing to implement the required electronic access controls so long as the routable protocol communications never leaves the asset containing the low impact BES Cyber System(s).

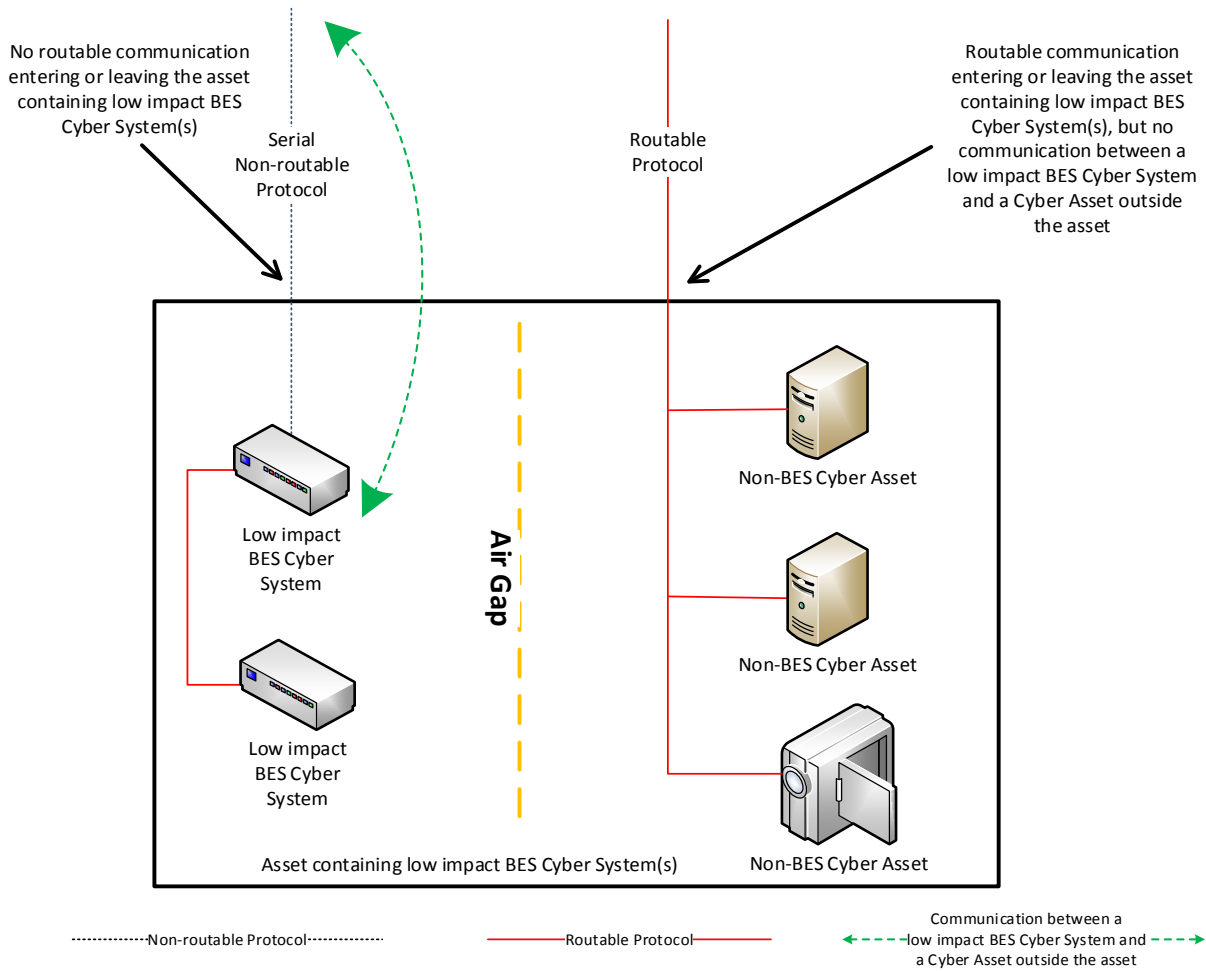

Reference Model 8

**Reference Model 9 – Logical Isolation - No Electronic Access Controls Required**

In this reference model, the criteria from Attachment 1, Section 3.1 requiring the implementation of electronic access controls are not met. The Responsible Entity has logically isolated the low impact BES Cyber System(s) from the routable protocol communication entering or leaving the asset containing low impact BES Cyber System(s). The logical network segmentation in this reference model permits no communication between a low impact BES Cyber System and a Cyber Asset outside the asset. Additionally, no indirect access exists because those non-BES Cyber Assets that are able to communicate outside the asset are strictly prohibited from communicating to the low impact BES Cyber System(s). The low impact BES Cyber System(s) is on an isolated network segment with logical controls preventing routable protocol communication into or out of the network containing the low impact BES Cyber System(s) and these communications never leave the asset using a routable protocol.



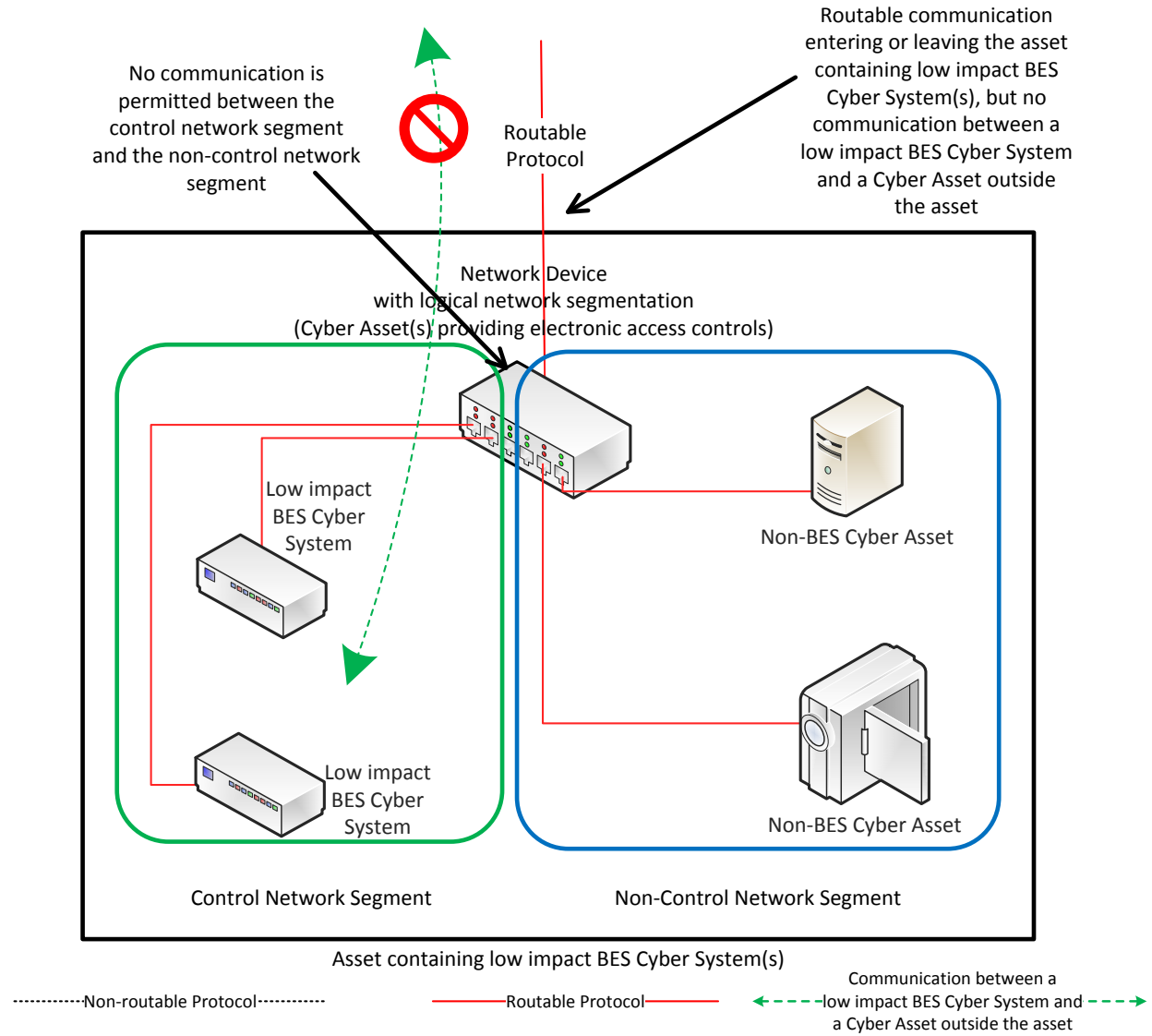

Reference Model 9

**Reference Model 10 - Serial Non-routable Communications Traversing an Isolated Channel on a Non-routable Transport Network – No Electronic Access Controls Required**

In this reference model, the criteria from Attachment 1, Section 3.1 requiring the implementation of electronic access controls are not met. This reference model depicts communication between a low impact BES Cyber System and a Cyber Asset outside the asset containing the low impact BES Cyber System over a serial non-routable protocol which is transported across a wide-area network using a protocol independent transport that may carry routable and non-routable communication such as a Time-Division Multiplexing (TDM) network, a Synchronous Optical Network (SONET), or a Multiprotocol Label Switching (MPLS) network. While there is routable protocol communication entering or leaving the asset containing low impact BES Cyber Systems(s) and there is communication between a low impact BES Cyber System and a Cyber Asset outside the asset, the communication between the low impact BES Cyber System and the Cyber Asset outside the asset is not using the routable protocol communication. This model is related to Reference Model 9 in that it relies on logical isolation to prohibit the communication between a low impact BES Cyber System and a Cyber Asset outside the asset from using a routable protocol.

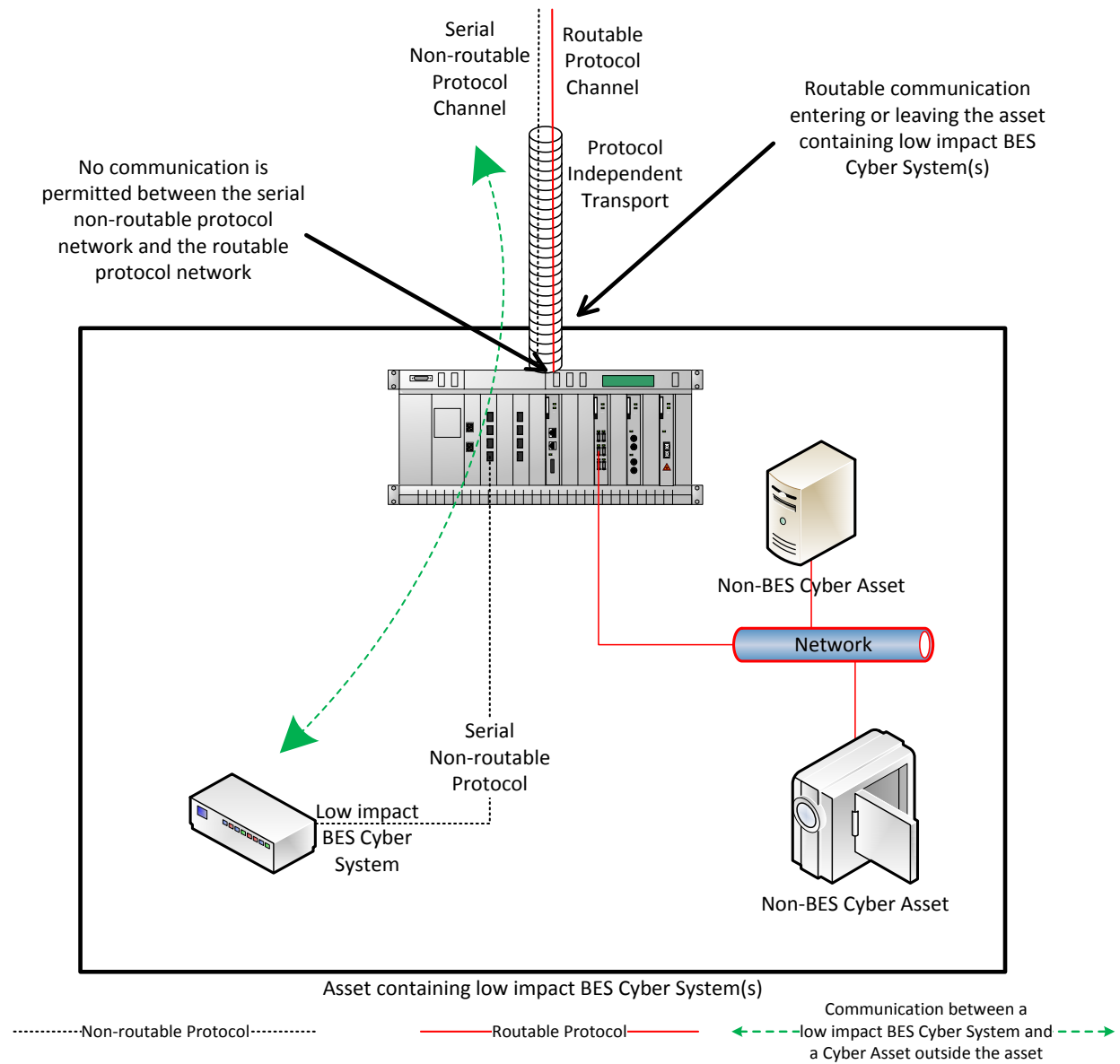

Reference Model 10

### Dial-up Connectivity

Dial-up Connectivity to a low impact BES Cyber System is set to dial out only (no auto-answer) to a preprogrammed number to deliver data. Incoming Dial-up Connectivity is to a dialback modem, a modem that must be remotely controlled by the control center or control room, has some form of access control, or the low impact BES Cyber System has access control.

### Insufficient Access Controls

Some examples of situations that would lack sufficient access controls to meet the intent of this requirement include:

- An asset has Dial-up Connectivity and a low impact BES Cyber System is reachable via an auto-answer modem that connects any caller to the Cyber Asset that has a default password. There is no practical access control in this instance.
- A low impact BES Cyber System has a wireless card on a public carrier that allows the BES Cyber System to be reachable via a public IP address. In essence, low impact BES Cyber Systems should not be accessible from the Internet and search engines such as Shodan.
- Dual-homing or multiple-network interface cards without disabling IP forwarding in the non-BES Cyber Asset within the DMZ to provide separation between the low impact BES Cyber System(s) and the external network would not meet the intent of “controlling” inbound and outbound electronic access assuming there was no other host-based firewall or other security devices on the non-BES Cyber Asset.

### Requirement R2, Attachment 1, Section 4 – Cyber Security Incident Response

The entity should have one or more documented Cyber Security Incident response plan(s) that include each of the topics listed in Section 4. If, in the normal course of business, suspicious activities are noted at an asset containing low impact BES Cyber System(s), the intent is for the entity to implement a Cyber Security Incident response plan that will guide the entity in responding to the incident and reporting the incident if it rises to the level of a Reportable Cyber Security Incident.

Entities are provided the flexibility to develop their Attachment 1, Section 4 Cyber Security Incident response plan(s) by asset or group of assets. The plans do not need to be on a per asset site or per low impact BES Cyber System basis. Entities can choose to use a single enterprise-wide plan to fulfill the obligations for low impact BES Cyber Systems.

The plan(s) must be tested once every 36 months. This is not an exercise per low impact BES Cyber Asset or per type of BES Cyber Asset but rather is an exercise of each incident response plan the entity created to meet this requirement. An actual Reportable Cyber Security Incident counts as an exercise as do other forms of tabletop exercises or drills. NERC-led exercises such as GridEx participation would also count as an exercise provided the entity’s response plan is followed. The intent of the requirement is for entities to keep the Cyber Security Incident response plan(s) current, which includes updating the plan(s), if needed, within 180 days following a test or an actual incident.

For low impact BES Cyber Systems, the only portion of the definition of Cyber Security Incident that would apply is, “A malicious act or suspicious event that disrupts, or was an attempt to

disrupt, the operation of a BES Cyber System.” The other portion of that definition is not to be used to require ESPs and PSPs for low impact BES Cyber Systems.

### **Requirement R2, Attachment 1, Section 5 – Transient Cyber Assets and Removable Media Malicious Code Risk Mitigation**

Most BES Cyber Assets and BES Cyber Systems are isolated from external public or untrusted networks, and therefore Transient Cyber Assets and Removable Media are needed to transport files to and from secure areas to maintain, monitor, or troubleshoot critical systems. Transient Cyber Assets and Removable Media are a potential means for cyber-attack. To protect the BES Cyber Assets and BES Cyber Systems, CIP-003 Requirement R2, Attachment 1, Section 5 requires Responsible Entities to document and implement a plan for how they will mitigate the risk of malicious code introduction to low impact BES Cyber Systems from Transient Cyber Assets and Removable Media. The approach of defining a plan allows the Responsible Entity to document processes that are supportable within its organization and in alignment with its change management processes.

Transient Cyber Assets can be one of many types of devices from a specially-designed device for maintaining equipment in support of the BES to a platform such as a laptop, desktop, or tablet that may interface with or run applications that support BES Cyber Systems and is capable of transmitting executable code to the BES Cyber Asset(s) or BES Cyber System(s). Note: Cyber Assets connected to a BES Cyber System for less than 30 days due to an unplanned removal, such as premature failure, are not intended to be identified as Transient Cyber Assets. Removable Media subject to this requirement include, among others, floppy disks, compact disks, USB flash drives, external hard drives, and other flash memory cards/drives that contain nonvolatile memory.

Examples of these temporarily connected devices include, but are not limited to:

- Diagnostic test equipment;
- Equipment used for BES Cyber System maintenance; or
- Equipment used for BES Cyber System configuration.

To meet the objective of mitigating risks associated with the introduction of malicious code at low impact BES Cyber Systems, Section 5 specifies the capabilities and possible security methods available to Responsible Entities based upon asset type and ownership.

With the list of options provided in Attachment 1, the entity has the discretion to use the option(s) that is most appropriate. This includes documenting its approach for how and when the entity reviews the Transient Cyber Asset under its control or under the control of parties other than the Responsible Entity. The entity should avoid implementing a security function that jeopardizes reliability by taking actions that would negatively impact the performance or support of the Transient Cyber Asset or BES Cyber Asset.

### Malicious Code Risk Mitigation

The terms “mitigate”, “mitigating”, and “mitigation” are used in Section 5 in Attachment 1 to address the risks posed by malicious code when connecting Transient Cyber Assets and Removable Media to BES Cyber Systems. Mitigation is intended to mean that entities reduce security risks presented by connecting the Transient Cyber Asset or Removable Media. When determining the method(s) to mitigate the introduction of malicious code, it is not intended for entities to perform and document a formal risk assessment associated with the introduction of malicious code.

### Per Transient Cyber Asset Capability

As with other CIP standards, the requirements are intended for an entity to use the method(s) that the system is capable of performing. The use of “per Transient Cyber Asset capability” is to eliminate the need for a Technical Feasibility Exception when it is understood that the device cannot use a method(s). For example, for malicious code, many types of appliances are not capable of implementing antivirus software; therefore, because it is not a capability of those types of devices, implementation of the antivirus software would not be required for those devices.

### **Requirement R2, Attachment 1, Section 5.1 - Transient Cyber Asset(s) Managed by the Responsible Entity**

For Transient Cyber Assets and Removable Media that are connected to both low impact and medium/high impact BES Cyber Systems, entities must be aware of the differing levels of requirements and manage these assets under the program that matches the highest impact level to which they will connect.

**Section 5.1:** Entities are to document and implement their plan(s) to mitigate malicious code through the use of one or more of the protective measures listed, based on the capability of the Transient Cyber Asset.

The Responsible Entity has the flexibility to apply the selected method(s) to meet the objective of mitigating the introductions of malicious code either in an on-going or in an on-demand manner. An example of managing a device in an on-going manner is having the antivirus solution for the device managed as part of an end-point security solution with current signature or pattern updates, regularly scheduled systems scans, etc. In contrast, for devices that are used infrequently and the signatures or patterns are not kept current, the entity may manage those devices in an on-demand manner by requiring an update to the signatures or patterns and a scan of the device before the device is connected to ensure that it is free of malicious code.

Selecting management in an on-going or on-demand manner is not intended to imply that the control has to be verified at every single connection. For example, if the device is managed in an on-demand manner, but will be used to perform maintenance on several BES Cyber Asset(s), the Responsible Entity may choose to document that the Transient Cyber Asset has been updated before being connected as a Transient Cyber Asset for the first use of that maintenance work. The intent is not to require a log documenting each connection of a Transient Cyber Asset to a BES Cyber Asset.

The following is additional discussion of the methods to mitigate the introduction of malicious code.

- Antivirus software, including manual or managed updates of signatures or patterns, provides flexibility to manage Transient Cyber Asset(s) by deploying antivirus or endpoint security tools that maintain a scheduled update of the signatures or patterns. Also, for devices that do not regularly connect to receive scheduled updates, entities may choose to update the signatures or patterns and scan the Transient Cyber Asset prior to connection to ensure no malicious software is present.
- Application whitelisting is a method of authorizing only the applications and processes that are necessary on the Transient Cyber Asset. This reduces the risk that malicious software could execute on the Transient Cyber Asset and impact the BES Cyber Asset or BES Cyber System.
- When using methods other than those listed, entities need to document how the other method(s) meet the objective of mitigating the risk of the introduction of malicious code.

If malicious code is discovered on the Transient Cyber Asset, it must be mitigated prior to connection to a BES Cyber System to prevent the malicious code from being introduced into the BES Cyber System. An entity may choose to not connect the Transient Cyber Asset to a BES Cyber System to prevent the malicious code from being introduced into the BES Cyber System. Entities should also consider whether the detected malicious code is a Cyber Security Incident.

### **Requirement R2, Attachment 1, Section 5.2 - Transient Cyber Asset(s) Managed by a Party Other than the Responsible Entity**

Section 5 also recognizes the lack of direct control over Transient Cyber Assets that are managed by parties other than the Responsible Entity. This lack of control, however, does not obviate the Responsible Entity's responsibility to ensure that methods have been deployed to mitigate the introduction of malicious code to low impact BES Cyber System(s) from Transient Cyber Assets it does not manage. Section 5 requires entities to review the other party's security practices with respect to Transient Cyber Assets to help meet the objective of the requirement. The use of "prior to connecting the Transient Cyber Assets" is intended to ensure that the Responsible Entity conducts the review before the first connection of the Transient Cyber Asset to help meet the objective to mitigate the introduction of malicious code. The SDT does not intend for the Responsible Entity to conduct a review for every single connection of that Transient Cyber Asset once the Responsible Entity has established the Transient Cyber Asset is meeting the security objective. The intent is to not require a log documenting each connection of a Transient Cyber Asset to a BES Cyber Asset.

To facilitate these controls, Responsible Entities may execute agreements with other parties to provide support services to BES Cyber Systems and BES Cyber Assets that may involve the use of Transient Cyber Assets. Entities may consider using the Department of Energy Cybersecurity Procurement Language for Energy Delivery dated April 2014.<sup>1</sup> Procurement language may unify

---

<sup>1</sup> <http://www.energy.gov/oe/downloads/cybersecurity-procurement-language-energy-delivery-april-2014>

the other party and entity actions supporting the BES Cyber Systems and BES Cyber Assets. CIP program attributes may be considered including roles and responsibilities, access controls, monitoring, logging, vulnerability, and patch management along with incident response and back up recovery may be part of the other party's support. Entities may consider the "General Cybersecurity Procurement Language" and "The Supplier's Life Cycle Security Program" when drafting Master Service Agreements, Contracts, and the CIP program processes and controls.

**Section 5.2.1:** Entities are to document and implement their process(es) to mitigate the introduction of malicious code through the use of one or more of the protective measures listed.

- Review the use of antivirus software and signature or pattern levels to ensure that the level is adequate to the Responsible Entity to mitigate the risk of malicious software being introduced to an applicable system.
- Review the antivirus or endpoint security processes of the other party to ensure that their processes are adequate to the Responsible Entity to mitigate the risk of introducing malicious software to an applicable system.
- Review the use of application whitelisting used by the other party to mitigate the risk of introducing malicious software to an applicable system.
- Review the use of live operating systems or software executable only from read-only media to ensure that the media is free from malicious software itself. Entities should review the processes to build the read-only media as well as the media itself.
- Review system hardening practices used by the other party to ensure that unnecessary ports, services, applications, etc. have been disabled or removed. This method intends to reduce the attack surface on the Transient Cyber Asset and reduce the avenues by which malicious software could be introduced.

**Section 5.2.2:** The intent of this section is to ensure that after conducting the selected review from Section 5.2.1, if there are deficiencies identified, actions mitigating the risk of the introduction of malicious code to low impact BES Cyber Systems must be completed prior to connecting the device(s) to an applicable system.

### **Requirement R2, Attachment 1, Section 5.3 - Removable Media**

Entities have a high level of control for Removable Media that are going to be connected to their BES Cyber Assets.

**Section 5.3:** Entities are to document and implement their process(es) to mitigate the introduction of malicious code through the use of one or more method(s) to detect malicious code on the Removable Media before it is connected to a BES Cyber Asset. When using the method(s) to detect malicious code, it is expected to occur from a system that is not part of the BES Cyber System to reduce the risk of propagating malicious code into the BES Cyber System



network or onto one of the BES Cyber Assets. If malicious code is discovered, it must be removed or mitigated to prevent it from being introduced into the BES Cyber Asset or BES Cyber System. Entities should also consider whether the detected malicious code is a Cyber Security Incident. Frequency and timing of the methods used to detect malicious code were intentionally excluded from the requirement because there are multiple timing scenarios that can be incorporated into a plan to mitigate the risk of malicious code. The SDT does not intend to obligate a Responsible Entity to conduct a review for every single connection of Removable Media, but rather to implement its plan(s) in a manner that protects all BES Cyber Systems where Removable Media may be used. The intent is to not require a log documenting each connection of Removable Media to a BES Cyber Asset.

As a method to detect malicious code, entities may choose to use Removable Media with on-board malicious code detection tools. For these tools, the Removable Media are still used in conjunction with a Cyber Asset to perform the detection. For Section 5.3.1, the Cyber Asset used to perform the malicious code detection must be outside of the BES Cyber System.

### **Requirement R3:**

The intent of CIP-003-8, Requirement R3 is effectively unchanged since prior versions of the standard. The specific description of the CIP Senior Manager has now been included as a defined term rather than clarified in the Reliability Standard itself to prevent any unnecessary cross-reference to this standard. It is expected that the CIP Senior Manager will play a key role in ensuring proper strategic planning, executive/board-level awareness, and overall program governance.

### **Requirement R4:**

As indicated in the rationale for CIP-003-8, Requirement R4, this requirement is intended to demonstrate a clear line of authority and ownership for security matters. The intent of the SDT was not to impose any particular organizational structure, but, rather, the intent is to afford the Responsible Entity significant flexibility to adapt this requirement to its existing organizational structure. A Responsible Entity may satisfy this requirement through a single delegation document or through multiple delegation documents. The Responsible Entity can make use of the delegation of the delegation authority itself to increase the flexibility in how this applies to its organization. In such a case, delegations may exist in numerous documentation records as long as the collection of these documentation records shows a clear line of authority back to the CIP Senior Manager. In addition, the CIP Senior Manager could also choose not to delegate any authority and meet this requirement without such delegation documentation.

The Responsible Entity must keep its documentation of the CIP Senior Manager and any delegations up-to-date. This is to ensure that individuals do not assume any undocumented authority. However, delegations do not have to be re-instated if the individual who delegated the task changes roles or the individual is replaced. For instance, assume that John Doe is named the CIP Senior Manager and he delegates a specific task to the Substation Maintenance Manager. If John Doe is replaced as the CIP Senior Manager, the CIP Senior Manager documentation must be updated within the specified timeframe, but the existing delegation to

the Substation Maintenance Manager remains in effect as approved by the previous CIP Senior Manager, John Doe.

### **Rationale:**

During development of this standard, text boxes were embedded within the standard to explain the rationale for various parts of the standard. Upon BOT approval, the text from the rationale text boxes was moved to this section.

### **Rationale for Requirement R1:**

One or more security policies enable effective implementation of the requirements of the cyber security Reliability Standards. The purpose of policies is to provide a management and governance foundation for all requirements that apply to a Responsible Entity's BES Cyber Systems. The Responsible Entity can demonstrate through its policies that its management supports the accountability and responsibility necessary for effective implementation of the requirements.

Annual review and approval of the cyber security policies ensures that the policies are kept-up-to-date and periodically reaffirms management's commitment to the protection of its BES Cyber Systems.

### **Rationale for Requirement R2:**

In response to FERC Order No. 791, Requirement R2 requires entities to develop and implement cyber security plans to meet specific security control objectives for assets containing low impact BES Cyber System(s). The cyber security plan(s) covers five subject matter areas: (1) cyber security awareness; (2) physical security controls; (3) electronic access controls; (4) Cyber Security Incident response; and (5) Transient Cyber Asset and Removable Media Malicious Code Risk Mitigation. This plan(s), along with the cyber security policies required under Requirement R1, Part 1.2, provides a framework for operational, procedural, and technical safeguards for low impact BES Cyber Systems.

Considering the varied types of low impact BES Cyber Systems across the BES, Attachment 1 provides Responsible Entities flexibility on how to apply the security controls to meet the security objectives. Additionally, because many Responsible Entities have multiple-impact rated BES Cyber Systems, nothing in the requirement prohibits entities from using their high and medium impact BES Cyber System policies, procedures, and processes to implement security controls required for low impact BES Cyber Systems, as detailed in Requirement R2, Attachment 1.

Responsible Entities will use their identified assets containing low impact BES Cyber System(s) (developed pursuant to CIP-002) to substantiate the sites or locations associated with low impact BES Cyber System(s). However, there is no requirement or compliance expectation for Responsible Entities to maintain a list(s) of individual low impact BES Cyber System(s) and their associated cyber assets or to maintain a list of authorized users.

### **Rationale for Modifications to Sections 2 and 3 of Attachment 1 (Requirement R2):**

Requirement R2 mandates that entities develop and implement one or more cyber security plan(s) to meet specific security objectives for assets containing low impact BES Cyber System(s). In Paragraph 73 of FERC Order No. 822, the Commission directed NERC to modify "...the Low Impact External Routable Connectivity definition to reflect the commentary in the Guidelines and Technical Basis section of CIP-003-6...to provide needed clarity to the definition

and eliminate ambiguity surrounding the term ‘direct’ as it is used in the proposed definition...within one year of the effective date of this Final Rule.”

The revisions to Section 3 incorporate select language from the LERC definition into Attachment 1 and focus the requirement on implementing electronic access controls for asset(s) containing low impact BES Cyber System(s). This change requires the Responsible Entity to permit only necessary inbound and outbound electronic access when using a routable protocol entering or leaving the asset between low impact BES Cyber System(s) and a Cyber Asset(s) outside the asset containing low impact BES Cyber system(s). When this communication is present, Responsible Entities are required to implement electronic access controls unless that communication meets the following exclusion language (previously in the definition of LERC) contained in romanette (iii): “not used for time-sensitive protection or control functions between intelligent electronic devices (e.g. communications using protocol IEC TR-61850-90-5 R-GOOSE)”.

The revisions to Section 2 of Attachment 1 complement the revisions to Section 3; consequently, the requirement now mandates the Responsible Entity control physical access to “the Cyber Asset(s), as specified by the Responsible Entity, that provide electronic access control(s) implemented for Section 3.1, if any.” The focus on electronic access controls rather than on the Low Impact BES Cyber System Electronic Access Points (LEAPs) eliminates the need for LEAPs.

Given these revisions to Sections 2 and 3, the NERC Glossary terms: Low Impact External Routable Connectivity (LERC) and Low Impact BES Cyber System Electronic Access Point (LEAP) will be retired.

### **Rationale for Section 5 of Attachment 1 (Requirement R2):**

Requirement R2 mandates that entities develop and implement one or more cyber security plan(s) to meet specific security objectives for assets containing low impact BES Cyber System(s). In Paragraph 32 of FERC Order No. 822, the Commission directed NERC to “...provide mandatory protection for transient devices used at Low Impact BES Cyber Systems based on the risk posed to bulk electric system reliability.” Transient devices are potential vehicles for introducing malicious code into low impact BES Cyber Systems. Section 5 of Attachment 1 is intended to mitigate the risk of malware propagation to the BES through low impact BES Cyber Systems by requiring entities to develop and implement one or more plan(s) to address the risk. The cyber security plan(s) along with the cyber security policies required under Requirement R1, Part 1.2, provide a framework for operational, procedural, and technical safeguards for low impact BES Cyber Systems.

### **Rationale for Requirement R3:**

The identification and documentation of the single CIP Senior Manager ensures that there is clear authority and ownership for the CIP program within an organization, as called for in Blackout Report Recommendation 43. The language that identifies CIP Senior Manager responsibilities is included in the Glossary of Terms used in NERC Reliability Standards so that it may be used across the body of CIP standards without an explicit cross-reference.

FERC Order No. 706, Paragraph 296, requests consideration of whether the single senior manager should be a corporate officer or equivalent. As implicated through the defined term, the senior manager has “the overall authority and responsibility for leading and managing implementation of the requirements within this set of standards” which ensures that the senior manager is of sufficient position in the Responsible Entity to ensure that cyber security receives the prominence that is necessary. In addition, given the range of business models for responsible entities, from municipal, cooperative, federal agencies, investor owned utilities, privately owned utilities, and everything in between, the SDT believes that requiring the CIP Senior Manager to be a “corporate officer or equivalent” would be extremely difficult to interpret and enforce on a consistent basis.

### **Rationale for Requirement R4:**

The intent of the requirement is to ensure clear accountability within an organization for certain security matters. It also ensures that delegations are kept up-to-date and that individuals do not assume undocumented authority.

In FERC Order No. 706, Paragraphs 379 and 381, the Commission notes that Recommendation 43 of the 2003 Blackout Report calls for “clear lines of authority and ownership for security matters.” With this in mind, the Standard Drafting Team has sought to provide clarity in the requirement for delegations so that this line of authority is clear and apparent from the documented delegations.

## Standard Development Timeline

This section is maintained by the drafting team during the development of the standard and will be removed when the standard is adopted by the NERC Board of Trustees (Board).

### Description of Current Draft

~~45-day initial formal comment period with a 10-day final~~ ballot.

Completed Actions	Date
Standards Committee approved Standard Authorization Request (SAR) for posting	June 13, 2018
SAR posted for comment	June <del>14</del> – July 13, 2018
<del>45-day formal comment period with ballot (initial)</del>	<del>August 23 – October 9, 2018</del>

Anticipated Actions	Date
<del>45-day formal comment period with ballot (initial)</del>	<del>August 23 – October 9, 2018</del>
10-day final ballot	<del>April 18 – 29, 2019</del> <del>October 29 – November 8, 2018</del>
Board adoption	<del>February</del> <u>May 8,</u> 2019

## A. Introduction

1. **Title:** Cyber Security — Security Management Controls
2. **Number:** CIP-003-8
3. **Purpose:** To specify consistent and sustainable security management controls that establish responsibility and accountability to protect BES Cyber Systems against compromise that could lead to misoperation or instability in the Bulk Electric System (BES).

### 4. Applicability:

**4.1. Functional Entities:** For the purpose of the requirements contained herein, the following list of functional entities will be collectively referred to as “Responsible Entities.” For requirements in this standard where a specific functional entity or subset of functional entities are the applicable entity or entities, the functional entity or entities are specified explicitly.

#### 4.1.1. Balancing Authority

**4.1.2. Distribution Provider** that owns one or more of the following Facilities, systems, and equipment for the protection or restoration of the BES:

**4.1.2.1.** Each underfrequency Load shedding (UFLS) or undervoltage Load shedding (UVLS) system that:

**4.1.2.1.1.** is part of a Load shedding program that is subject to one or more requirements in a NERC or Regional Reliability Standard; and

**4.1.2.1.2.** performs automatic Load shedding under a common control system owned by the Responsible Entity, without human operator initiation, of 300 MW or more.

**4.1.2.2.** Each Remedial Action Scheme (RAS) where the RAS is subject to one or more requirements in a NERC or Regional Reliability Standard.

**4.1.2.3.** Each Protection System (excluding UFLS and UVLS) that applies to Transmission where the Protection System is subject to one or more requirements in a NERC or Regional Reliability Standard.

**4.1.2.4.** Each Cranking Path and group of Elements meeting the initial switching requirements from a Blackstart Resource up to and including the first interconnection point of the starting station service of the next generation unit(s) to be started.

#### 4.1.3. Generator Operator

#### 4.1.4. Generator Owner

#### 4.1.5. Reliability Coordinator

#### 4.1.6. Transmission Operator

**4.1.7. Transmission Owner**

**4.2. Facilities:** For the purpose of the requirements contained herein, the following Facilities, systems, and equipment owned by each Responsible Entity in Section 4.1 above are those to which these requirements are applicable. For requirements in this standard where a specific type of Facilities, system, or equipment or subset of Facilities, systems, and equipment are applicable, these are specified explicitly.

**4.2.1. Distribution Provider:** One or more of the following Facilities, systems and equipment owned by the Distribution Provider for the protection or restoration of the BES:

**4.2.1.1.** Each UFLS or UVLS System that:

**4.2.1.1.1.** is part of a Load shedding program that is subject to one or more requirements in a NERC or Regional Reliability Standard; and

**4.2.1.1.2.** performs automatic Load shedding under a common control system owned by the Responsible Entity, without human operator initiation, of 300 MW or more.

**4.2.1.2.** Each RAS where the RAS is subject to one or more requirements in a NERC or Regional Reliability Standard.

**4.2.1.3.** Each Protection System (excluding UFLS and UVLS) that applies to Transmission where the Protection System is subject to one or more requirements in a NERC or Regional Reliability Standard.

**4.2.1.4.** Each Cranking Path and group of Elements meeting the initial switching requirements from a Blackstart Resource up to and including the first interconnection point of the starting station service of the next generation unit(s) to be started.

**4.2.2. Responsible Entities listed in 4.1 other than Distribution Providers:**

All BES Facilities.

**4.2.3. Exemptions:** The following are exempt from Standard CIP-003-8:

**4.2.3.1.** Cyber Assets at Facilities regulated by the Canadian Nuclear Safety Commission.

**4.2.3.2.** Cyber Assets associated with communication networks and data communication links between discrete Electronic Security Perimeters (ESPs).

**4.2.3.3.** The systems, structures, and components that are regulated by the Nuclear Regulatory Commission under a cyber security plan pursuant to 10 C.F.R. Section 73.54.

**4.2.3.4.** For Distribution Providers, the systems and equipment that are not included in section 4.2.1 above.



## 5. Effective Dates:

See Implementation Plan for CIP-003-8.

~~5.1. **Planned and Unplanned Changes:** For any Planned Change or Unplanned Change, as those terms are defined in the Effective Dates Section of Reliability Standard CIP-002, the Responsible Entity must comply with the requirements in this Reliability Standard on the date the Responsible Entity must comply with the requirements in Reliability Standard CIP-002 following a Planned Change or Unplanned Change.~~

## 6. Background:

Standard CIP-003 exists as part of a suite of CIP Standards related to cyber security, which require the initial identification and categorization of BES Cyber Systems and require organizational, operational, and procedural controls to mitigate risk to BES Cyber Systems.

The term policy refers to one or a collection of written documents that are used to communicate the Responsible Entities' management goals, objectives and expectations for how the Responsible Entity will protect its BES Cyber Systems. The use of policies also establishes an overall governance foundation for creating a culture of security and compliance with laws, regulations, and standards.

The term documented processes refers to a set of required instructions specific to the Responsible Entity and to achieve a specific outcome. This term does not imply any naming or approval structure beyond what is stated in the requirements. An entity should include as much as it believes necessary in its documented processes, but it must address the applicable requirements.

The terms program and plan are sometimes used in place of documented processes where it makes sense and is commonly understood. For example, documented processes describing a response are typically referred to as plans (i.e., incident response plans and recovery plans). Likewise, a security plan can describe an approach involving multiple procedures to address a broad subject matter.

Similarly, the term program may refer to the organization's overall implementation of its policies, plans, and procedures involving a subject matter. Examples in the standards include the personnel risk assessment program and the personnel training program. The full implementation of the CIP Cyber Security Reliability Standards could also be referred to as a program. However, the terms program and plan do not imply any additional requirements beyond what is stated in the standards.

Responsible Entities can implement common controls that meet requirements for multiple high, medium, and low impact BES Cyber Systems. For example, a single cyber security awareness program could meet the requirements across multiple BES Cyber Systems.

Measures provide examples of evidence to show documentation and implementation of the requirement. These measures serve to provide guidance to entities in acceptable records of compliance and should not be viewed as an all-inclusive list.

Throughout the standards, unless otherwise stated, bulleted items in the requirements and measures are items that are linked with an “or,” and numbered items are items that are linked with an “and.”

Many references in the Applicability section use a threshold of 300 MW for UFLS and UVLS. This particular threshold of 300 MW for UVLS and UFLS was provided in Version 1 of the CIP Cyber Security Standards. The threshold remains at 300 MW since it is specifically addressing UVLS and UFLS, which are last ditch efforts to save the BES. A review of UFLS tolerances defined within Regional Reliability Standards for UFLS program requirements to date indicates that the historical value of 300 MW represents an adequate and reasonable threshold value for allowable UFLS operational tolerances.

## B. Requirements and Measures

- R1.** Each Responsible Entity shall review and obtain CIP Senior Manager approval at least once every 15 calendar months for one or more documented cyber security policies that collectively address the following topics: *[Violation Risk Factor: Medium] [Time Horizon: Operations Planning]*
- 1.1.** For its high impact and medium impact BES Cyber Systems, if any:
    - 1.1.1.** Personnel and training (CIP-004);
    - 1.1.2.** Electronic Security Perimeters (CIP-005) including Interactive Remote Access;
    - 1.1.3.** Physical security of BES Cyber Systems (CIP-006);
    - 1.1.4.** System security management (CIP-007);
    - 1.1.5.** Incident reporting and response planning (CIP-008);
    - 1.1.6.** Recovery plans for BES Cyber Systems (CIP-009);
    - 1.1.7.** Configuration change management and vulnerability assessments (CIP-010);
    - 1.1.8.** Information protection (CIP-011); and
    - 1.1.9.** Declaring and responding to CIP Exceptional Circumstances.
  - 1.2.** For its assets identified in CIP-002 containing low impact BES Cyber Systems, if any:
    - 1.2.1.** Cyber security awareness;
    - 1.2.2.** Physical security controls;
    - 1.2.3.** Electronic access controls;
    - 1.2.4.** Cyber Security Incident response;
    - 1.2.5.** Transient Cyber Assets and Removable Media malicious code risk mitigation; and
    - 1.2.6.** Declaring and responding to CIP Exceptional Circumstances.
- M1.** Examples of evidence may include, but are not limited to, policy documents; revision history, records of review, or workflow evidence from a document management system that indicate review of each cyber security policy at least once every 15 calendar months; and documented approval by the CIP Senior Manager for each cyber security policy.
- R2.** Each Responsible Entity with at least one asset identified in CIP-002 containing low impact BES Cyber Systems shall implement one or more documented cyber security plan(s) for its low impact BES Cyber Systems that include the sections in Attachment 1. *[Violation Risk Factor: Lower] [Time Horizon: Operations Planning]*

Note: An inventory, list, or discrete identification of low impact BES Cyber Systems or their BES Cyber Assets is not required. Lists of authorized users are not required.

- M2.** Evidence shall include each of the documented cyber security plan(s) that collectively include each of the sections in Attachment 1 and additional evidence to demonstrate implementation of the cyber security plan(s). Additional examples of evidence per section are located in Attachment 2.
- R3.** Each Responsible Entity shall identify a CIP Senior Manager by name and document any change within 30 calendar days of the change. *[Violation Risk Factor: Medium]*  
*[Time Horizon: Operations Planning]*
- M3.** An example of evidence may include, but is not limited to, a dated and approved document from a high level official designating the name of the individual identified as the CIP Senior Manager.
- R4.** The Responsible Entity shall implement a documented process to delegate authority, unless no delegations are used. Where allowed by the CIP Standards, the CIP Senior Manager may delegate authority for specific actions to a delegate or delegates. These delegations shall be documented, including the name or title of the delegate, the specific actions delegated, and the date of the delegation; approved by the CIP Senior Manager; and updated within 30 days of any change to the delegation. Delegation changes do not need to be reinstated with a change to the delegator. *[Violation Risk Factor: Lower]* *[Time Horizon: Operations Planning]*
- M4.** An example of evidence may include, but is not limited to, a dated document, approved by the CIP Senior Manager, listing individuals (by name or title) who are delegated the authority to approve or authorize specifically identified items.

## C. Compliance

### 1. Compliance Monitoring Process

#### 1.1. Compliance Enforcement Authority:

As defined in the NERC Rules of Procedure, “Compliance Enforcement Authority” (CEA) means NERC or the Regional Entity in their respective roles of monitoring and enforcing compliance with the NERC Reliability Standards.

#### 1.2. Evidence Retention:

The following evidence retention periods identify the period of time an entity is required to retain specific evidence to demonstrate compliance. For instances where the evidence retention period specified below is shorter than the time since the last audit, the CEA may ask an entity to provide other evidence to show that it was compliant for the full time period since the last audit.

The Responsible Entity shall keep data or evidence to show compliance as identified below unless directed by its CEA to retain specific evidence for a longer period of time as part of an investigation:

- Each Responsible Entity shall retain evidence of each requirement in this standard for three calendar years.
- If a Responsible Entity is found non-compliant, it shall keep information related to the non-compliance until mitigation is complete and approved or for the time specified above, whichever is longer.
- The CEA shall keep the last audit records and all requested and submitted subsequent audit records.

#### 1.3. Compliance Monitoring and Assessment Processes:

- Compliance Audits
- Self-Certifications
- Spot Checking
- Compliance Investigations
- Self-Reporting
- Complaints

#### 1.4. Additional Compliance Information:

None.

### Violation Severity Levels

R #	Time Horizon	VRF	Violation Severity Levels (CIP-003-8)			
			Lower VSL	Moderate VSL	High VSL	Severe VSL
<b>R1</b>	<b>Operations Planning</b>	<b>Medium</b>	<p>The Responsible Entity documented and implemented one or more cyber security policies for its high impact and medium impact BES Cyber Systems, but did not address one of the nine topics required by R1. (R1.1)</p> <p>OR</p> <p>The Responsible Entity did not complete its review of the one or more documented cyber security policies for its high impact and medium impact BES Cyber Systems as required by R1 within 15 calendar months but did</p>	<p>The Responsible Entity documented and implemented one or more cyber security policies for its high impact and medium impact BES Cyber Systems, but did not address two of the nine topics required by R1. (R1.1)</p> <p>OR</p> <p>The Responsible Entity did not complete its review of the one or more documented cyber security policies for its high impact and medium impact BES Cyber Systems as required by R1 within 16 calendar months but did</p>	<p>The Responsible Entity documented and implemented one or more cyber security policies for its high impact and medium impact BES Cyber Systems, but did not address three of the nine topics required by R1. (R1.1)</p> <p>OR</p> <p>The Responsible Entity did not complete its review of the one or more documented cyber security policies for its high impact and medium impact BES Cyber Systems as required by R1 within 17 calendar months but did complete this review in less than or equal to 18</p>	<p>The Responsible Entity documented and implemented one or more cyber security policies for its high impact and medium impact BES Cyber Systems, but did not address four or more of the nine topics required by R1. (R1.1)</p> <p>OR</p> <p>The Responsible Entity did not have any documented cyber security policies for its high impact and medium impact BES Cyber Systems as required by R1. (R1.1)</p> <p>OR</p> <p>The Responsible Entity did not</p>

R #	Time Horizon	VRF	Violation Severity Levels (CIP-003-8)			
			Lower VSL	Moderate VSL	High VSL	Severe VSL
			complete this review in less than or equal to 16 calendar months of the previous review. (R1.1) OR The Responsible Entity did not complete its approval of the one or more documented cyber security policies for its high impact and medium impact BES Cyber Systems as required by R1 by the CIP Senior Manager within 15 calendar months but did complete this approval in less than or equal to 16 calendar months of the previous approval. (R1.1)	complete this review in less than or equal to 17 calendar months of the previous review. (R1.1) OR The Responsible Entity did not complete its approval of the one or more documented cyber security policies for its high impact and medium impact BES Cyber Systems as required by R1 by the CIP Senior Manager within 16 calendar months but did complete this approval in less than or equal to 17 calendar months of the previous approval. (R1.1)	calendar months of the previous review. (R1.1) OR The Responsible Entity did not complete its approval of the one or more documented cyber security policies for its high impact and medium impact BES Cyber Systems as required by R1 by the CIP Senior Manager within 17 calendar months but did complete this approval in less than or equal to 18 calendar months of the previous approval. (R1) OR The Responsible Entity documented one or more cyber security policies for its assets identified in CIP-002 containing low impact	complete its review of the one or more documented cyber security policies as required by R1 within 18 calendar months of the previous review. (R1) OR The Responsible Entity did not complete its approval of the one or more documented cyber security policies for its high impact and medium impact BES Cyber Systems as required by R1 by the CIP Senior Manager within 18 calendar months of the previous approval. (R1.1) OR

R #	Time Horizon	VRF	Violation Severity Levels (CIP-003-8)			
			Lower VSL	Moderate VSL	High VSL	Severe VSL
			<p>OR</p> <p>The Responsible Entity documented one or more cyber security policies for its assets identified in CIP-002 containing low impact BES Cyber Systems, but did not address one of the six topics required by R1. (R1.2)</p> <p>OR</p> <p>The Responsible Entity did not complete its review of the one or more documented cyber security policies for its assets identified in CIP-002 containing low impact BES Cyber Systems as required by Requirement R1 within 15 calendar</p>	<p>OR</p> <p>The Responsible Entity documented one or more cyber security policies for its assets identified in CIP-002 containing low impact BES Cyber Systems, but did not address two of the six topics required by R1. (R1.2)</p> <p>OR</p> <p>The Responsible Entity did not complete its review of the one or more documented cyber security policies for its assets identified in CIP-002 containing low impact BES Cyber Systems as required by Requirement R1 within 16 calendar</p>	<p>BES Cyber Systems, but did not address three of the six topics required by R1. (R1.2)</p> <p>OR</p> <p>The Responsible Entity did not complete its review of the one or more documented cyber security policies for its assets identified in CIP-002 containing low impact BES Cyber Systems as required by R1 within 17 calendar months but did complete this review in less than or equal to 18 calendar months of the previous review. (R1.2)</p> <p>OR</p> <p>The Responsible Entity did not complete its approval of the one or more documented cyber security policies for its</p>	<p>The Responsible Entity documented one or more cyber security policies for its assets identified in CIP-002 containing low impact BES Cyber Systems, but did not address four or more of the six topics required by R1. (R1.2)</p> <p>OR</p> <p>The Responsible Entity did not have any documented cyber security policies for its assets identified in CIP-002 containing low impact BES Cyber Systems as required by R1. (R1.2)</p> <p>OR</p> <p>The Responsible Entity did not</p>



R #	Time Horizon	VRF	Violation Severity Levels (CIP-003-8)			
			Lower VSL	Moderate VSL	High VSL	Severe VSL
			<p>months but did complete this review in less than or equal to 16 calendar months of the previous review. (R1.2)</p> <p>OR</p> <p>The Responsible Entity did not complete its approval of the one or more documented cyber security policies for its assets identified in CIP-002 containing low impact BES Cyber Systems as required by Requirement R1 by the CIP Senior Manager within 15 calendar months but did complete this approval in less than or equal to 16 calendar months of</p>	<p>months but did complete this review in less than or equal to 17 calendar months of the previous review. (R1.2)</p> <p>OR</p> <p>The Responsible Entity did not complete its approval of the one or more documented cyber security policies for its assets identified in CIP-002 containing low impact BES Cyber Systems as required by Requirement R1 by the CIP Senior Manager within 16 calendar months but did complete this approval in less than or equal to 17</p>	<p>assets identified in CIP-002 containing low impact BES Cyber Systems as required by Requirement R1 by the CIP Senior Manager within 17 calendar months but did complete this approval in less than or equal to 18 calendar months of the previous approval. (R1.2)</p>	<p>complete its approval of the one or more documented cyber security policies for its assets identified in CIP-002 containing low impact BES Cyber Systems as required by Requirement R1 by the CIP Senior Manager within 18 calendar months of the previous approval. (R1.2)</p>

R #	Time Horizon	VRF	Violation Severity Levels (CIP-003-8)			
			Lower VSL	Moderate VSL	High VSL	Severe VSL
			the previous approval. (R1.2)	calendar months of the previous approval. (R1.2)		
<b>R2</b>	<b>Operations Planning</b>	<b>Lower</b>	<p>The Responsible Entity documented its cyber security plan(s) for its assets containing low impact BES Cyber Systems, but failed to document cyber security awareness according to Requirement R2, Attachment 1, Section 1. (R2)</p> <p>OR</p> <p>The Responsible Entity implemented electronic access controls but failed to document its cyber security plan(s) for electronic access controls according to Requirement R2,</p>	<p>The Responsible Entity documented its cyber security plan(s) for its assets containing low impact BES Cyber Systems, but failed to reinforce cyber security practices at least once every 15 calendar months according to Requirement R2, Attachment 1, Section 1. (R2)</p> <p>OR</p> <p>The Responsible Entity documented its cyber security plan(s) for its assets containing low impact BES Cyber Systems, but failed</p>	<p>The Responsible Entity documented the physical access controls for its assets containing low impact BES Cyber Systems, but failed to implement the physical security controls according to Requirement R2, Attachment 1, Section 2. (R2)</p> <p>OR</p> <p>The Responsible Entity documented its cyber security plan(s) for electronic access controls for its assets containing low impact BES Cyber Systems, but failed to permit only necessary inbound and outbound electronic</p>	<p>The Responsible Entity failed to document and implement one or more cyber security plan(s) for its assets containing low impact BES Cyber Systems according to Requirement R2, Attachment 1. (R2)</p>

R #	Time Horizon	VRF	Violation Severity Levels (CIP-003-8)			
			Lower VSL	Moderate VSL	High VSL	Severe VSL
			<p>Attachment 1, Section 3. (R2)</p> <p>OR</p> <p>The Responsible Entity documented its cyber security plan(s) for its assets containing low impact BES Cyber Systems, but failed to document one or more Cyber Security Incident response plan(s) according to Requirement R2, Attachment 1, Section 4. (R2)</p> <p>OR</p> <p>The Responsible Entity documented one or more Cyber Security Incident response plan(s) within its cyber security plan(s) for its assets containing</p>	<p>to document physical security controls according to Requirement R2, Attachment 1, Section 2. (R2)</p> <p>OR</p> <p>The Responsible Entity documented its cyber security plan(s) for its assets containing low impact BES Cyber Systems, but failed to document electronic access controls according to Requirement R2, Attachment 1, Section 3. (R2)</p> <p>OR</p> <p>The Responsible Entity documented its cyber security plan(s) for electronic access controls but</p>	<p>access controls according to Requirement R2, Attachment 1, Section 3.1. (R2)</p> <p>OR</p> <p>The Responsible Entity documented one or more Cyber Security Incident response plan(s) within its cyber security plan(s) for its assets containing low impact BES Cyber Systems, but failed to test each Cyber Security Incident response plan(s) at least once every 36 calendar months according to Requirement R2, Attachment 1, Section 4. (R2)</p> <p>OR</p> <p>The Responsible Entity documented the determination of</p>	

R #	Time Horizon	VRF	Violation Severity Levels (CIP-003-8)			
			Lower VSL	Moderate VSL	High VSL	Severe VSL
			low impact BES Cyber Systems, but failed to update each Cyber Security Incident response plan(s) within 180 days according to Requirement R2, Attachment 1, Section 4. (R2) OR The Responsible Entity documented its plan(s) for Transient Cyber Assets and Removable Media, but failed to manage its Transient Cyber Asset(s) according to Requirement R2, Attachment 1, Section 5.1. (R2) OR The Responsible Entity documented	failed to implement authentication for all Dial-up Connectivity that provides access to low impact BES Cyber System(s), per Cyber Asset capability according to Requirement R2, Attachment 1, Section 3.2 (R2) OR The Responsible Entity documented one or more incident response plan(s) within its cyber security plan(s) for its assets containing low impact BES Cyber Systems, but failed to include the process for identification, classification, and response to Cyber Security Incidents	whether an identified Cyber Security Incident is a Reportable Cyber Security Incident, but failed to notify the Electricity Information Sharing and Analysis Center (E-ISAC) according to Requirement R2, Attachment 1, Section 4. (R2) OR The Responsible Entity documented its plan(s) for Transient Cyber Assets and Removable Media, but failed to implement mitigation for the introduction of malicious code for Transient Cyber Assets managed by the Responsible Entity according to Requirement R2,	

R #	Time Horizon	VRF	Violation Severity Levels (CIP-003-8)			
			Lower VSL	Moderate VSL	High VSL	Severe VSL
			its plan(s) for Transient Cyber Assets, but failed to document the Removable Media section(s) according to Requirement R2, Attachment 1, Section 5.3. (R2)	according to Requirement R2, Attachment 1, Section 4. (R2)  OR The Responsible Entity documented its cyber security plan(s) for its assets containing low impact BES Cyber Systems, but failed to document the determination of whether an identified Cyber Security Incident is a Reportable Cyber Security Incident and subsequent notification to the Electricity Information Sharing and Analysis Center (E-ISAC) according to Requirement R2,	Attachment 1, Section 5.1. (R2)  OR The Responsible Entity documented its plan(s) for Transient Cyber Assets and Removable Media, but failed to implement mitigation for the introduction of malicious code for Transient Cyber Assets managed by a party other than the Responsible Entity according to Requirement R2, Attachment 1, Section 5.2. (R2)  OR The Responsible Entity documented its plan(s) for Transient Cyber Assets and Removable Media, but failed to implement mitigation for	

R #	Time Horizon	VRF	Violation Severity Levels (CIP-003-8)			
			Lower VSL	Moderate VSL	High VSL	Severe VSL
				<p>Attachment 1, Section 4. (R2)</p> <p>OR</p> <p>The Responsible Entity documented its plan(s) for Transient Cyber Assets and Removable Media, but failed to document mitigation for the introduction of malicious code for Transient Cyber Assets managed by the Responsible Entity according to Requirement R2, Attachment 1, Sections 5.1 and 5.3. (R2)</p> <p>OR</p> <p>The Responsible Entity documented its plan(s) for Transient Cyber</p>	<p>the threat of detected malicious code on the Removable Media prior to connecting Removable Media to a low impact BES Cyber System according to Requirement R2, Attachment 1, Section 5.3. (R2)</p>	

R #	Time Horizon	VRF	Violation Severity Levels (CIP-003-8)			
			Lower VSL	Moderate VSL	High VSL	Severe VSL
				<p>Assets and Removable Media, but failed to document mitigation for the introduction of malicious code for Transient Cyber Assets managed by a party other than the Responsible Entity according to Requirement R2, Attachment 1, Section 5.2. (R2)</p> <p>OR</p> <p>The Responsible Entity documented its plan(s) for Transient Cyber Assets and Removable Media, but failed to implement the Removable Media section(s) according to Requirement R2,</p>		

R #	Time Horizon	VRF	Violation Severity Levels (CIP-003-8)			
			Lower VSL	Moderate VSL	High VSL	Severe VSL
				Attachment 1, Section 5.3. (R2)		
<b>R3</b>	<b>Operations Planning</b>	<b>Medium</b>	The Responsible Entity has identified by name a CIP Senior Manager, but did not document changes to the CIP Senior Manager within 30 calendar days but did document this change in less than 40 calendar days of the change. (R3)	The Responsible Entity has identified by name a CIP Senior Manager, but did not document changes to the CIP Senior Manager within 40 calendar days but did document this change in less than 50 calendar days of the change. (R3)	The Responsible Entity has identified by name a CIP Senior Manager, but did not document changes to the CIP Senior Manager within 50 calendar days but did document this change in less than 60 calendar days of the change. (R3)	The Responsible Entity has not identified, by name, a CIP Senior Manager.  OR The Responsible Entity has identified by name a CIP Senior Manager, but did not document changes to the CIP Senior Manager within 60 calendar days of the change. (R3)
<b>R4</b>	<b>Operations Planning</b>	<b>Lower</b>	The Responsible Entity has identified a delegate by name, title, date of delegation, and specific actions delegated, but did	The Responsible Entity has identified a delegate by name, title, date of delegation, and specific actions delegated, but did	The Responsible Entity has identified a delegate by name, title, date of delegation, and specific actions delegated, but did not document changes to the delegate	The Responsible Entity has used delegated authority for actions where allowed by the CIP Standards, but does not have a process



R #	Time Horizon	VRF	Violation Severity Levels (CIP-003-8)			
			Lower VSL	Moderate VSL	High VSL	Severe VSL
			not document changes to the delegate within 30 calendar days but did document this change in less than 40 calendar days of the change. (R4)	not document changes to the delegate within 40 calendar days but did document this change in less than 50 calendar days of the change. (R4)	within 50 calendar days but did document this change in less than 60 calendar days of the change. (R4)	to delegate actions from the CIP Senior Manager. (R4)  OR The Responsible Entity has identified a delegate by name, title, date of delegation, and specific actions delegated, but did not document changes to the delegate within 60 calendar days of the change. (R4)

**D. Regional Variances**

None.

**E. Interpretations**

None.

**F. Associated Documents**

None.

## Version History

Version	Date	Action	Change Tracking
1	1/16/06	R3.2 — Change “Control Center” to “control center.”	3/24/06
2	9/30/09	<p>Modifications to clarify the requirements and to bring the compliance elements into conformance with the latest guidelines for developing compliance elements of standards.</p> <p>Removal of reasonable business judgment.</p> <p>Replaced the RRO with the RE as a responsible entity.</p> <p>Rewording of Effective Date.</p> <p>Changed compliance monitor to Compliance Enforcement Authority.</p>	
3	12/16/09	<p>Updated Version Number from -2 to -3</p> <p>In Requirement 1.6, deleted the sentence pertaining to removing component or system from service in order to perform testing, in response to FERC order issued September 30, 2009.</p>	
3	12/16/09	Approved by the NERC Board of Trustees.	
3	3/31/10	Approved by FERC.	
4	1/24/11	Approved by the NERC Board of Trustees.	
5	11/26/12	Adopted by the NERC Board of Trustees.	Modified to coordinate with other CIP standards and to revise format to use RBS Template.
5	11/22/13	FERC Order issued approving CIP-003-5.	

Version	Date	Action	Change Tracking
6	11/13/14	Adopted by the NERC Board of Trustees.	Addressed two FERC directives from Order No. 791 related to identify, assess, and correct language and communication networks.
6	2/12/15	Adopted by the NERC Board of Trustees.	Replaces the version adopted by the Board on 11/13/2014. Revised version addresses remaining directives from Order No. 791 related to transient devices and low impact BES Cyber Systems.
6	1/21/16	FERC Order issued approving CIP-003-6. Docket No. RM15-14-000	
7	2/9/17	Adopted by the NERC Board of Trustees.	Revised to address FERC Order No. 822 directives regarding (1) the definition of LERC and (2) transient devices.
7	4/19/18	FERC Order issued approving CIP-003-7. Docket No. RM17-11-000	

Version	Date	Action	Change Tracking
8	<u>TBD</u>	FERC Order issued approving CIP-003-7. Docket No. RM17-11-000	

## Attachment 1

### Required Sections for Cyber Security Plan(s) for Assets Containing Low Impact BES Cyber Systems

Responsible Entities shall include each of the sections provided below in the cyber security plan(s) required under Requirement R2.

Responsible Entities with multiple-impact BES Cyber Systems ratings can utilize policies, procedures, and processes for their high or medium impact BES Cyber Systems to fulfill the sections for the development of low impact cyber security plan(s). Each Responsible Entity can develop a cyber security plan(s) either by individual asset or groups of assets.

**Section 1. Cyber Security Awareness:** Each Responsible Entity shall reinforce, at least once every 15 calendar months, cyber security practices (which may include associated physical security practices).

**Section 2. Physical Security Controls:** Each Responsible Entity shall control physical access, based on need as determined by the Responsible Entity, to (1) the asset or the locations of the low impact BES Cyber Systems within the asset, and (2) the Cyber Asset(s), as specified by the Responsible Entity, that provide electronic access control(s) implemented for Section 3.1, if any.

**Section 3. Electronic Access Controls:** For each asset containing low impact BES Cyber System(s) identified pursuant to CIP-002, the Responsible Entity shall implement electronic access controls to:

- 3.1** Permit only necessary inbound and outbound electronic access as determined by the Responsible Entity for any communications that are:
  - i. between a low impact BES Cyber System(s) and a Cyber Asset(s) outside the asset containing low impact BES Cyber System(s);
  - ii. using a routable protocol when entering or leaving the asset containing the low impact BES Cyber System(s); and
  - iii. not used for time-sensitive protection or control functions between intelligent electronic devices (e.g., communications using protocol IEC TR-61850-90-5 R-GOOSE).
- 3.2** Authenticate all Dial-up Connectivity, if any, that provides access to low impact BES Cyber System(s), per Cyber Asset capability.

**Section 4. Cyber Security Incident Response:** Each Responsible Entity shall have one or more Cyber Security Incident response plan(s), either by asset or group of assets, which shall include:

- 4.1** Identification, classification, and response to Cyber Security Incidents;
- 4.2** Determination of whether an identified Cyber Security Incident is a Reportable Cyber Security Incident and subsequent notification to the

Electricity Information Sharing and Analysis Center (E-ISAC), unless prohibited by law;

- 4.3 Identification of the roles and responsibilities for Cyber Security Incident response by groups or individuals;
- 4.4 Incident handling for Cyber Security Incidents;
- 4.5 Testing the Cyber Security Incident response plan(s) at least once every 36 calendar months by: (1) responding to an actual Reportable Cyber Security Incident; (2) using a drill or tabletop exercise of a Reportable Cyber Security Incident; or (3) using an operational exercise of a Reportable Cyber Security Incident; and
- 4.6 Updating the Cyber Security Incident response plan(s), if needed, within 180 calendar days after completion of a Cyber Security Incident response plan(s) test or actual Reportable Cyber Security Incident.

**Section 5. Transient Cyber Asset and Removable Media Malicious Code Risk Mitigation:** Each Responsible Entity shall implement, except under CIP Exceptional Circumstances, one or more plan(s) to achieve the objective of mitigating the risk of the introduction of malicious code to low impact BES Cyber Systems through the use of Transient Cyber Assets or Removable Media. The plan(s) shall include:

- 5.1 For Transient Cyber Asset(s) managed by the Responsible Entity, if any, the use of one or a combination of the following in an ongoing or on-demand manner (per Transient Cyber Asset capability):
  - Antivirus software, including manual or managed updates of signatures or patterns;
  - Application whitelisting; or
  - Other method(s) to mitigate the introduction of malicious code.
- 5.2 For Transient Cyber Asset(s) managed by a party other than the Responsible Entity, if any:
  - 5.2.1 Use one or a combination of the following prior to connecting the Transient Cyber Asset to a low impact BES Cyber System (per Transient Cyber Asset capability):
    - Review of antivirus update level;
    - Review of antivirus update process used by the party;
    - Review of application whitelisting used by the party;
    - Review use of live operating system and software executable only from read-only media;
    - Review of system hardening used by the party; or

- Other method(s) to mitigate the introduction of malicious code.
- 5.2.2** For any method used pursuant to 5.2.1, Responsible Entities shall determine whether any additional mitigation actions are necessary and implement such actions prior to connecting the Transient Cyber Asset.
- 5.3** For Removable Media, the use of each of the following:
- 5.3.1** Method(s) to detect malicious code on Removable Media using a Cyber Asset other than a BES Cyber System; and
  - 5.3.2** Mitigation of the threat of detected malicious code on the Removable Media prior to connecting Removable Media to a low impact BES Cyber System.

## Attachment 2

### Examples of Evidence for Cyber Security Plan(s) for Assets Containing Low Impact BES Cyber Systems

**Section 1. Cyber Security Awareness:** An example of evidence for Section 1 may include, but is not limited to, documentation that the reinforcement of cyber security practices occurred at least once every 15 calendar months. The evidence could be documentation through one or more of the following methods:

- Direct communications (for example, e-mails, memos, or computer-based training);
- Indirect communications (for example, posters, intranet, or brochures); or
- Management support and reinforcement (for example, presentations or meetings).

**Section 2. Physical Security Controls:** Examples of evidence for Section 2 may include, but are not limited to:

- Documentation of the selected access control(s) (e.g., card key, locks, perimeter controls), monitoring controls (e.g., alarm systems, human observation), or other operational, procedural, or technical physical security controls that control physical access to both:
  - a. The asset, if any, or the locations of the low impact BES Cyber Systems within the asset; and
  - b. The Cyber Asset(s) specified by the Responsible Entity that provide(s) electronic access controls implemented for Attachment 1, Section 3.1, if any.

**Section 3. Electronic Access Controls:** Examples of evidence for Section 3 may include, but are not limited to:

1. Documentation showing that at each asset or group of assets containing low impact BES Cyber Systems, routable communication between a low impact BES Cyber System(s) and a Cyber Asset(s) outside the asset is restricted by electronic access controls to permit only inbound and outbound electronic access that the Responsible Entity deems necessary, except where an entity provides rationale that communication is used for time-sensitive protection or control functions between intelligent electronic devices. Examples of such documentation may include, but are not limited to representative diagrams that illustrate control of inbound and outbound communication(s) between the low impact BES Cyber System(s) and a Cyber Asset(s) outside the asset containing low impact BES Cyber System(s) or lists of implemented electronic access controls (e.g., access control lists restricting IP addresses, ports, or services; implementing unidirectional gateways).



2. Documentation of authentication for Dial-up Connectivity (e.g., dial out only to a preprogrammed number to deliver data, dial-back modems, modems that must be remotely controlled by the control center or control room, or access control on the BES Cyber System).

**Section 4. Cyber Security Incident Response:** An example of evidence for Section 4 may include, but is not limited to, dated documentation, such as policies, procedures, or process documents of one or more Cyber Security Incident response plan(s) developed either by asset or group of assets that include the following processes:

1. to identify, classify, and respond to Cyber Security Incidents; to determine whether an identified Cyber Security Incident is a Reportable Cyber Security Incident and for notifying the Electricity Information Sharing and Analysis Center (E-ISAC);
2. to identify and document the roles and responsibilities for Cyber Security Incident response by groups or individuals (e.g., initiating, documenting, monitoring, reporting, etc.);
3. for incident handling of a Cyber Security Incident (e.g., containment, eradication, or recovery/incident resolution);
4. for testing the plan(s) along with the dated documentation that a test has been completed at least once every 36 calendar months; and
5. to update, as needed, Cyber Security Incident response plan(s) within 180 calendar days after completion of a test or actual Reportable Cyber Security Incident.

**Section 5. Transient Cyber Asset and Removable Media Malicious Code Risk Mitigation:**

1. Examples of evidence for Section 5.1 may include, but are not limited to, documentation of the method(s) used to mitigate the introduction of malicious code such as antivirus software and processes for managing signature or pattern updates, application whitelisting practices, processes to restrict communication, or other method(s) to mitigate the introduction of malicious code. If a Transient Cyber Asset does not have the capability to use method(s) that mitigate the introduction of malicious code, evidence may include documentation by the vendor or Responsible Entity that identifies that the Transient Cyber Asset does not have the capability.
2. Examples of evidence for Section 5.2.1 may include, but are not limited to, documentation from change management systems, electronic mail or procedures that document a review of the installed antivirus update level; memoranda, electronic mail, system documentation, policies or contracts from the party other than the Responsible Entity that identify the antivirus update process, the use of application whitelisting, use of live operating systems or system hardening performed by the party other than the Responsible Entity; evidence from change management systems, electronic mail or contracts that

identifies the Responsible Entity's acceptance that the practices of the party other than the Responsible Entity are acceptable; or documentation of other method(s) to mitigate malicious code for Transient Cyber Asset(s) managed by a party other than the Responsible Entity. If a Transient Cyber Asset does not have the capability to use method(s) that mitigate the introduction of malicious code, evidence may include documentation by the Responsible Entity or the party other than the Responsible Entity that identifies that the Transient Cyber Asset does not have the capability.

Examples of evidence for Attachment 1, Section 5.2.2 may include, but are not limited to, documentation from change management systems, electronic mail, or contracts that identifies a review to determine whether additional mitigation is necessary and has been implemented prior to connecting the Transient Cyber Asset managed by a party other than the Responsible Entity.

3. Examples of evidence for Section 5.3.1 may include, but are not limited to, documented process(es) of the method(s) used to detect malicious code such as results of scan settings for Removable Media, or implementation of on-demand scanning. Examples of evidence for Section 5.3.2 may include, but are not limited to, documented process(es) for the method(s) used for mitigating the threat of detected malicious code on Removable Media, such as logs from the method(s) used to detect malicious code that show the results of scanning and the mitigation of detected malicious code on Removable Media or documented confirmation by the entity that the Removable Media was deemed to be free of malicious code.

## Guidelines and Technical Basis

### Section 4 – Scope of Applicability of the CIP Cyber Security Standards

Section “4. Applicability” of the standards provides important information for Responsible Entities to determine the scope of the applicability of the CIP Cyber Security Requirements.

Section “4.1. Functional Entities” is a list of NERC functional entities to which the standard applies. If the entity is registered as one or more of the functional entities listed in Section 4.1, then the NERC CIP Cyber Security Standards apply. Note that there is a qualification in Section 4.1 that restricts the applicability in the case of Distribution Providers to only those that own certain types of systems and equipment listed in 4.2.

Section “4.2. Facilities” defines the scope of the Facilities, systems, and equipment owned by the Responsible Entity, as qualified in Section 4.1, that is subject to the requirements of the standard. In addition to the set of BES Facilities, Control Centers, and other systems and equipment, the list includes the set of systems and equipment owned by Distribution Providers. While the NERC Glossary term “Facilities” already includes the BES characteristic, the additional use of the term BES here is meant to reinforce the scope of applicability of these Facilities where it is used, especially in this applicability scoping section. This in effect sets the scope of Facilities, systems, and equipment that is subject to the standards.

#### Requirement R1:

In developing policies in compliance with Requirement R1, the number of policies and their content should be guided by a Responsible Entity's management structure and operating conditions. Policies might be included as part of a general information security program for the entire organization, or as components of specific programs. The Responsible Entity has the flexibility to develop a single comprehensive cyber security policy covering the required topics, or it may choose to develop a single high-level umbrella policy and provide additional policy detail in lower level documents in its documentation hierarchy. In the case of a high-level umbrella policy, the Responsible Entity would be expected to provide the high-level policy as well as the additional documentation in order to demonstrate compliance with CIP-003-8, Requirement R1.

If a Responsible Entity has any high or medium impact BES Cyber Systems, the one or more cyber security policies must cover the nine subject matter areas required by CIP-003-8, Requirement R1, Part 1.1. If a Responsible Entity has identified from CIP-002 any assets containing low impact BES Cyber Systems, the one or more cyber security policies must cover the six subject matter areas required by Requirement R1, Part 1.2.

Responsible Entities that have multiple-impact rated BES Cyber Systems are not required to create separate cyber security policies for high, medium, or low impact BES Cyber Systems. The Responsible Entities have the flexibility to develop policies that cover all three impact ratings.

Implementation of the cyber security policy is not specifically included in CIP-003-8, Requirement R1 as it is envisioned that the implementation of this policy is evidenced through successful implementation of CIP-003 through CIP-011. However, Responsible Entities are encouraged not to limit the scope of their cyber security policies to only those requirements in NERC cyber security Reliability Standards, but to develop a holistic cyber security policy

appropriate for its organization. Elements of a policy that extend beyond the scope of NERC's cyber security Reliability Standards will not be considered candidates for potential violations although they will help demonstrate the organization's internal culture of compliance and posture towards cyber security.

For Part 1.1, the Responsible Entity may consider the following for each of the required topics in its one or more cyber security policies for medium and high impact BES Cyber Systems, if any:

### 1.1.1 Personnel and training (CIP-004)

- Organization position on acceptable background investigations
- Identification of possible disciplinary action for violating this policy
- Account management

### 1.1.2 Electronic Security Perimeters (CIP-005) including Interactive Remote Access

- Organization stance on use of wireless networks
- Identification of acceptable authentication methods
- Identification of trusted and untrusted resources
- Monitoring and logging of ingress and egress at Electronic Access Points
- Maintaining up-to-date anti-malware software before initiating Interactive Remote Access
- Maintaining up-to-date patch levels for operating systems and applications used to initiate Interactive Remote Access
- Disabling VPN "split-tunneling" or "dual-homed" workstations before initiating Interactive Remote Access
- For vendors, contractors, or consultants: include language in contracts that requires adherence to the Responsible Entity's Interactive Remote Access controls

### 1.1.3 Physical security of BES Cyber Systems (CIP-006)

- Strategy for protecting Cyber Assets from unauthorized physical access
- Acceptable physical access control methods
- Monitoring and logging of physical ingress

### 1.1.4 System security management (CIP-007)

- Strategies for system hardening
- Acceptable methods of authentication and access control
- Password policies including length, complexity, enforcement, prevention of brute force attempts
- Monitoring and logging of BES Cyber Systems

- 1.1.5 Incident reporting and response planning (CIP-008)
  - Recognition of Cyber Security Incidents
  - Appropriate notifications upon discovery of an incident
  - Obligations to report Cyber Security Incidents
- 1.1.6 Recovery plans for BES Cyber Systems (CIP-009)
  - Availability of spare components
  - Availability of system backups
- 1.1.7 Configuration change management and vulnerability assessments (CIP-010)
  - Initiation of change requests
  - Approval of changes
  - Break-fix processes
- 1.1.8 Information protection (CIP-011)
  - Information access control methods
  - Notification of unauthorized information disclosure
  - Information access on a need-to-know basis
- 1.1.9 Declaring and responding to CIP Exceptional Circumstances
  - Processes to invoke special procedures in the event of a CIP Exceptional Circumstance
  - Processes to allow for exceptions to policy that do not violate CIP requirements

For Part 1.2, the Responsible Entity may consider the following for each of the required topics in its one or more cyber security policies for assets containing low impact BES Cyber Systems, if any:

- 1.2.1 Cyber security awareness
  - Method(s) for delivery of security awareness
  - Identification of groups to receive cyber security awareness
- 1.2.2 Physical security controls
  - Acceptable approach(es) for selection of physical security control(s)
- 1.2.3 Electronic access controls
  - Acceptable approach(es) for selection of electronic access control(s)
- 1.2.4 Cyber Security Incident response
  - Recognition of Cyber Security Incidents

- Appropriate notifications upon discovery of an incident
- Obligations to report Cyber Security Incidents

### 1.2.5 Transient Cyber Assets and Removable Media Malicious Code Risk Mitigation

- Acceptable use of Transient Cyber Asset(s) and Removable Media
- Method(s) to mitigate the risk of the introduction of malicious code to low impact BES Cyber Systems from Transient Cyber Assets and Removable Media
- Method(s) to request Transient Cyber Asset and Removable Media

### 1.2.6 Declaring and responding to CIP Exceptional Circumstances

- Process(es) to declare a CIP Exceptional Circumstance
- Process(es) to respond to a declared CIP Exceptional Circumstance

Requirements relating to exceptions to a Responsible Entity's security policies were removed because it is a general management issue that is not within the scope of a reliability requirement. It is an internal policy requirement and not a reliability requirement. However, Responsible Entities are encouraged to continue this practice as a component of their cyber security policies.

In this and all subsequent required approvals in the NERC CIP Reliability Standards, the Responsible Entity may elect to use hardcopy or electronic approvals to the extent that there is sufficient evidence to ensure the authenticity of the approving party.

#### **Requirement R2:**

The intent of Requirement R2 is for each Responsible Entity to create, document, and implement one or more cyber security plan(s) that address the security objective for the protection of low impact BES Cyber Systems. The required protections are designed to be part of a program that covers the low impact BES Cyber Systems collectively at an asset level (based on the list of assets containing low impact BES Cyber Systems identified in CIP-002), but not at an individual device or system level.

### **Requirement R2, Attachment 1**

As noted, Attachment 1 contains the sections that must be included in the cyber security plan(s). The intent is to allow entities that have a combination of high, medium, and low impact BES Cyber Systems the flexibility to choose, if desired, to cover their low impact BES Cyber Systems (or any subset) under their programs used for the high or medium impact BES Cyber Systems rather than maintain two separate programs. The purpose of the cyber security plan(s) in Requirement R2 is for Responsible Entities to use the cyber security plan(s) as a means of documenting their approaches to meeting the subject matter areas. The cyber security plan(s) can be used to reference other policies and procedures that demonstrate “how” the Responsible Entity is meeting each of the subject matter areas, or Responsible Entities can develop comprehensive cyber security plan(s) that contain all of the detailed implementation content solely within the cyber security plan itself. To meet the obligation for the cyber security plan, the expectation is that the cyber security plan contains or references sufficient details to address the implementation of each of the required subject matters areas.

Guidance for each of the subject matter areas of Attachment 1 is provided below.

#### **Requirement R2, Attachment 1, Section 1 – Cyber Security Awareness**

The intent of the cyber security awareness program is for entities to reinforce good cyber security practices with their personnel at least once every 15 calendar months. The entity has the discretion to determine the topics to be addressed and the manner in which it will communicate these topics. As evidence of compliance, the Responsible Entity should be able to produce the awareness material that was delivered according to the delivery method(s) (e.g., posters, emails, or topics at staff meetings, etc.). The standard drafting team does not intend for Responsible Entities to be required to maintain lists of recipients and track the reception of the awareness material by personnel.

Although the focus of the awareness is cyber security, it does not mean that only technology-related topics can be included in the program. Appropriate physical security topics (e.g., tailgating awareness and protection of badges for physical security, or “If you see something, say something” campaigns, etc.) are valid for cyber security awareness. The intent is to cover topics concerning any aspect of the protection of BES Cyber Systems.

#### **Requirement R2, Attachment 1, Section 2 – Physical Security Controls**

The Responsible Entity must document and implement methods to control physical access to (1) the asset or the locations of low impact BES Cyber Systems within the asset, and (2) Cyber Assets that implement the electronic access control(s) specified by the Responsible Entity in Attachment 1, Section 3.1, if any. If these Cyber Assets implementing the electronic access controls are located within the same asset as the low impact BES Cyber Asset(s) and inherit the same physical access controls and the same need as outlined in Section 2, this may be noted by the Responsible Entity in either its policies or cyber security plan(s) to avoid duplicate documentation of the same controls.

The Responsible Entity has the flexibility to select the methods used to meet the objective of controlling physical access to (1) the asset(s) containing low impact BES Cyber System(s) or the low impact BES Cyber Systems themselves and (2) the electronic access control Cyber Assets specified by the Responsible Entity, if any. The Responsible Entity may use one or a

combination of physical access controls, monitoring controls, or other operational, procedural, or technical physical security controls. Entities may use perimeter controls (e.g., fences with locked gates, guards, or site access policies, etc.) or more granular areas of physical access control in areas where low impact BES Cyber Systems are located, such as control rooms or control houses.

The security objective is to control the physical access based on need as determined by the Responsible Entity. The need for physical access can be documented at the policy level. The standard drafting team did not intend to obligate an entity to specify a need for each physical access or authorization of an individual for physical access.

Monitoring as a physical security control can be used as a complement or an alternative to physical access control. Examples of monitoring controls include, but are not limited to: (1) alarm systems to detect motion or entry into a controlled area, or (2) human observation of a controlled area. Monitoring does not necessarily require logging and maintaining logs but could include monitoring that physical access has occurred or been attempted (e.g., door alarm, or human observation, etc.). The standard drafting team's intent is that the monitoring does not need to be per low impact BES Cyber System but should be at the appropriate level to meet the security objective of controlling physical access.

User authorization programs and lists of authorized users for physical access are not required although they are an option to meet the security objective.

**Requirement R2, Attachment 1, Section 3 – Electronic Access Controls**

Section 3 requires the establishment of electronic access controls for assets containing low impact BES Cyber Systems when there is routable protocol communication or Dial-up Connectivity between Cyber Asset(s) outside of the asset containing the low impact BES Cyber System(s) and the low impact BES Cyber System(s) within such asset. The establishment of electronic access controls is intended to reduce the risks associated with uncontrolled communication using routable protocols or Dial-up Connectivity.

When implementing Attachment 1, Section 3.1, Responsible Entities should note that electronic access controls to permit only necessary inbound and outbound electronic access are required for communications when those communications meet all three of the criteria identified in Attachment 1, Section 3.1. The Responsible Entity should evaluate the communications and when all three criteria are met, the Responsible Entity must document and implement electronic access control(s).

When identifying electronic access controls, Responsible Entities are provided flexibility in the selection of the electronic access controls that meet their operational needs while meeting the security objective of allowing only necessary inbound and outbound electronic access to low impact BES Cyber Systems that use routable protocols between a low impact BES Cyber System(s) and Cyber Asset(s) outside the asset.

In essence, the intent is for Responsible Entities to determine whether there is communication between a low impact BES Cyber System(s) and a Cyber Asset(s) outside the asset containing low impact BES Cyber System(s) that uses a routable protocol when entering or leaving the asset or Dial-up Connectivity to the low impact BES Cyber System(s). Where such



communication is present, Responsible Entities should document and implement electronic access control(s). Where routable protocol communication for time-sensitive protection or control functions between intelligent electronic devices that meets the exclusion language is present, Responsible Entities should document that communication, but are not required to establish any specific electronic access controls.

The inputs to this requirement are the assets identified in CIP-002 as containing low impact BES Cyber System(s); therefore, the determination of routable protocol communications or Dial-up Connectivity is an attribute of the asset. However, it is not intended for communication that provides no access to or from the low impact BES Cyber System(s), but happens to be located at the asset with the low impact BES Cyber System(s), to be evaluated for electronic access controls.

### Electronic Access Control Exclusion

In order to avoid future technology issues, the obligations for electronic access controls exclude communications between intelligent electronic devices that use routable communication protocols for time-sensitive protection or control functions, such as IEC TR-61850-90-5 R-GOOSE messaging. Time-sensitive in this context generally means functions that would be negatively impacted by the latency introduced in the communications by the required electronic access controls. This time-sensitivity exclusion does not apply to SCADA communications which typically operate on scan rates of 2 seconds or greater. While technically time-sensitive, SCADA communications over routable protocols can withstand the delay introduced by electronic access controls. Examples of excluded time-sensitive communications are those communications which may necessitate the tripping of a breaker within a few cycles. A Responsible Entity using this technology is not expected to implement the electronic access controls noted herein. This exception was included so as not to inhibit the functionality of the time-sensitive characteristics related to this technology and not to preclude the use of such time-sensitive reliability enhancing functions if they use a routable protocol in the future.

### **Considerations for Determining Routable Protocol Communications**

To determine whether electronic access controls need to be implemented, the Responsible Entity has to determine whether there is communication between a low impact BES Cyber System(s) and a Cyber Asset(s) outside the asset containing the low impact BES Cyber System(s) that uses a routable protocol when entering or leaving the asset.

When determining whether a routable protocol is entering or leaving the asset containing the low impact BES Cyber System(s), Responsible Entities have flexibility in identifying an approach. One approach is for Responsible Entities to identify an “electronic boundary” associated with the asset containing low impact BES Cyber System(s). This is not an Electronic Security Perimeter *per se*, but a demarcation that demonstrates the routable protocol communication entering or leaving the asset between a low impact BES Cyber System and Cyber Asset(s) outside the asset to then have electronic access controls implemented. This electronic boundary may vary by asset type (Control Center, substation, generation resource) and the specific configuration of the asset. If this approach is used, the intent is for the Responsible Entity to define the electronic boundary such that the low impact BES Cyber System(s) located

at the asset are contained within the “electronic boundary.” This is strictly for determining which routable protocol communications and networks are internal or inside or local to the asset and which are external to or outside the asset.

Alternatively, the Responsible Entity may find the concepts of what is inside and outside to be intuitively obvious for a Cyber Asset(s) outside the asset containing low impact BES Cyber System(s) communicating to a low impact BES Cyber System(s) inside the asset. This may be the case when a low impact BES Cyber System(s) is communicating with a Cyber Asset many miles away and a clear and unambiguous demarcation exists. In this case, a Responsible Entity may decide not to identify an “electronic boundary,” but rather to simply leverage the unambiguous asset demarcation to ensure that the electronic access controls are placed between the low impact BES Cyber System(s) and the Cyber Asset(s) outside the asset.

### **Determining Electronic Access Controls**

Once a Responsible Entity has determined that there is routable communication between a low impact BES Cyber System(s) and a Cyber Asset(s) outside the asset containing the low impact BES Cyber System(s) that uses a routable protocol when entering or leaving the asset containing the low impact BES Cyber System(s), the intent is for the Responsible Entity to document and implement its chosen electronic access control(s). The control(s) are intended to allow only “necessary” inbound and outbound electronic access as determined by the Responsible Entity. However the Responsible Entity chooses to document the inbound and outbound access permissions and the need, the intent is that the Responsible Entity is able to explain the reasons for the electronic access permitted. The reasoning for “necessary” inbound and outbound electronic access controls may be documented within the Responsible Entity’s cyber security plan(s), within a comment on an access control list, a database, spreadsheet or other policies or procedures associated with the electronic access controls.

### **Concept Diagrams**

The diagrams on the following pages are provided as examples to illustrate various electronic access controls at a conceptual level. Regardless of the concepts or configurations chosen by the Responsible Entity, the intent is to achieve the security objective of permitting only necessary inbound and outbound electronic access for communication between low impact BES Cyber Systems and Cyber Asset(s) outside the asset containing the low impact BES Cyber System(s) using a routable protocol when entering or leaving the asset.

#### **NOTE:**

- This is not an exhaustive list of applicable concepts.
- The same legend is used in each diagram; however, the diagram may not contain all of the articles represented in the legend.

### Reference Model 1 – Host-based Inbound & Outbound Access Permissions

The Responsible Entity may choose to utilize a host-based firewall technology on the low impact BES Cyber System(s) itself that manages the inbound and outbound electronic access permissions so that only necessary inbound and outbound electronic access is allowed between the low impact BES Cyber System(s) and the Cyber Asset(s) outside the asset containing the low impact BES Cyber System(s). When permitting the inbound and outbound electronic access permissions using access control lists, the Responsible Entity could restrict communication(s) using source and destination addresses or ranges of addresses. Responsible Entities could also restrict communication(s) using ports or services based on the capability of the electronic access control, the low impact BES Cyber System(s), or the application(s).

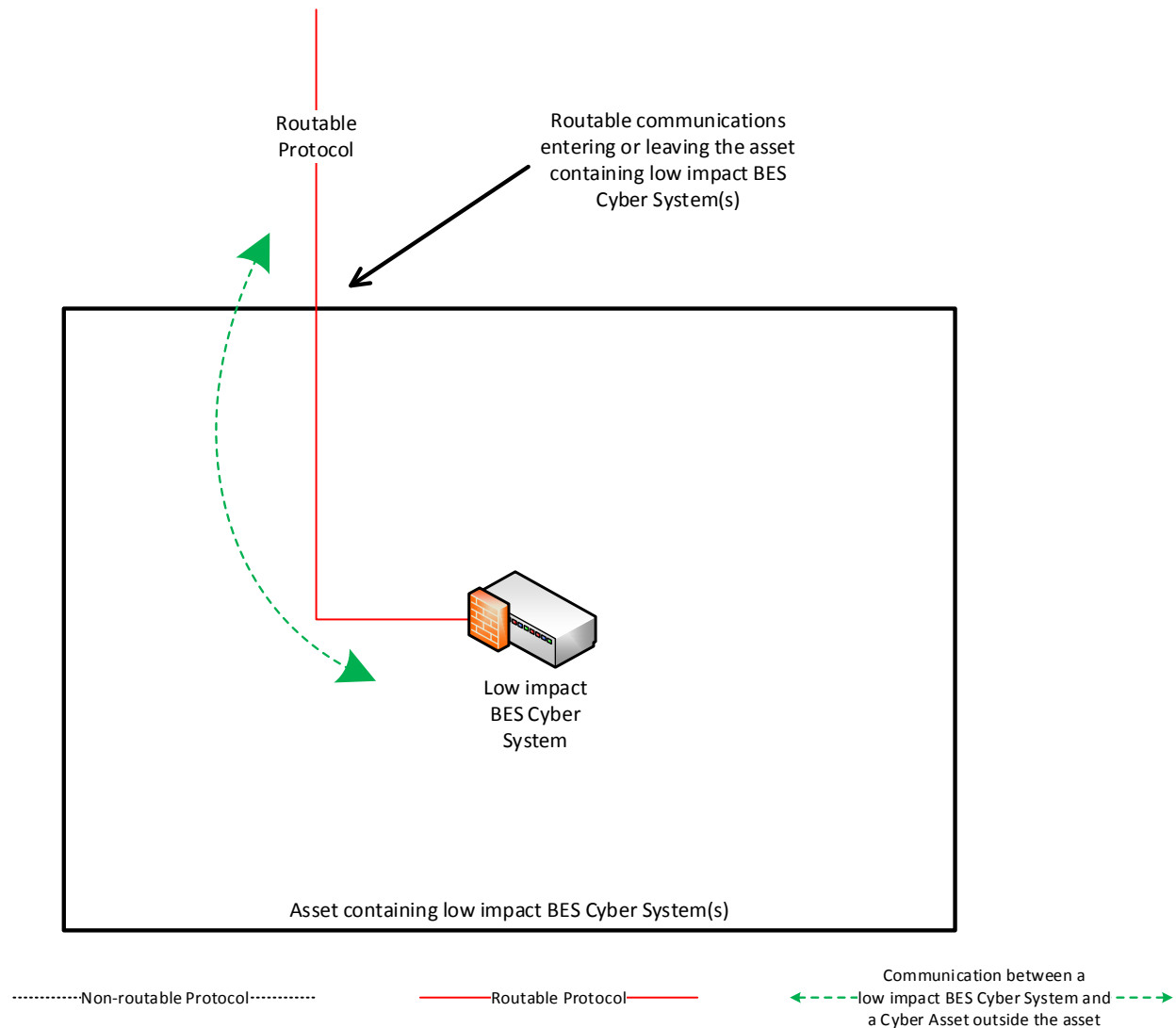

Reference Model 1

**Reference Model 2 – Network-based Inbound & Outbound Access Permissions**

The Responsible Entity may choose to use a security device that permits only necessary inbound and outbound electronic access to the low impact BES Cyber System(s) within the asset containing the low impact BES Cyber System(s). In this example, two low impact BES Cyber Systems are accessed using the routable protocol that is entering or leaving the asset containing the low impact BES Cyber System(s). The IP/Serial converter is continuing the same communications session from the Cyber Asset(s) that are outside the asset to the low impact BES Cyber System(s). The security device provides the electronic access controls to permit only necessary inbound and outbound routable protocol access to the low impact BES Cyber System(s). When permitting the inbound and outbound electronic access permissions using access control lists, the Responsible Entity could restrict communication(s) using source and destination addresses or ranges of addresses. Responsible Entities could also restrict communication(s) using ports or services based on the capability of the electronic access control, the low impact BES Cyber System(s), or the application(s).

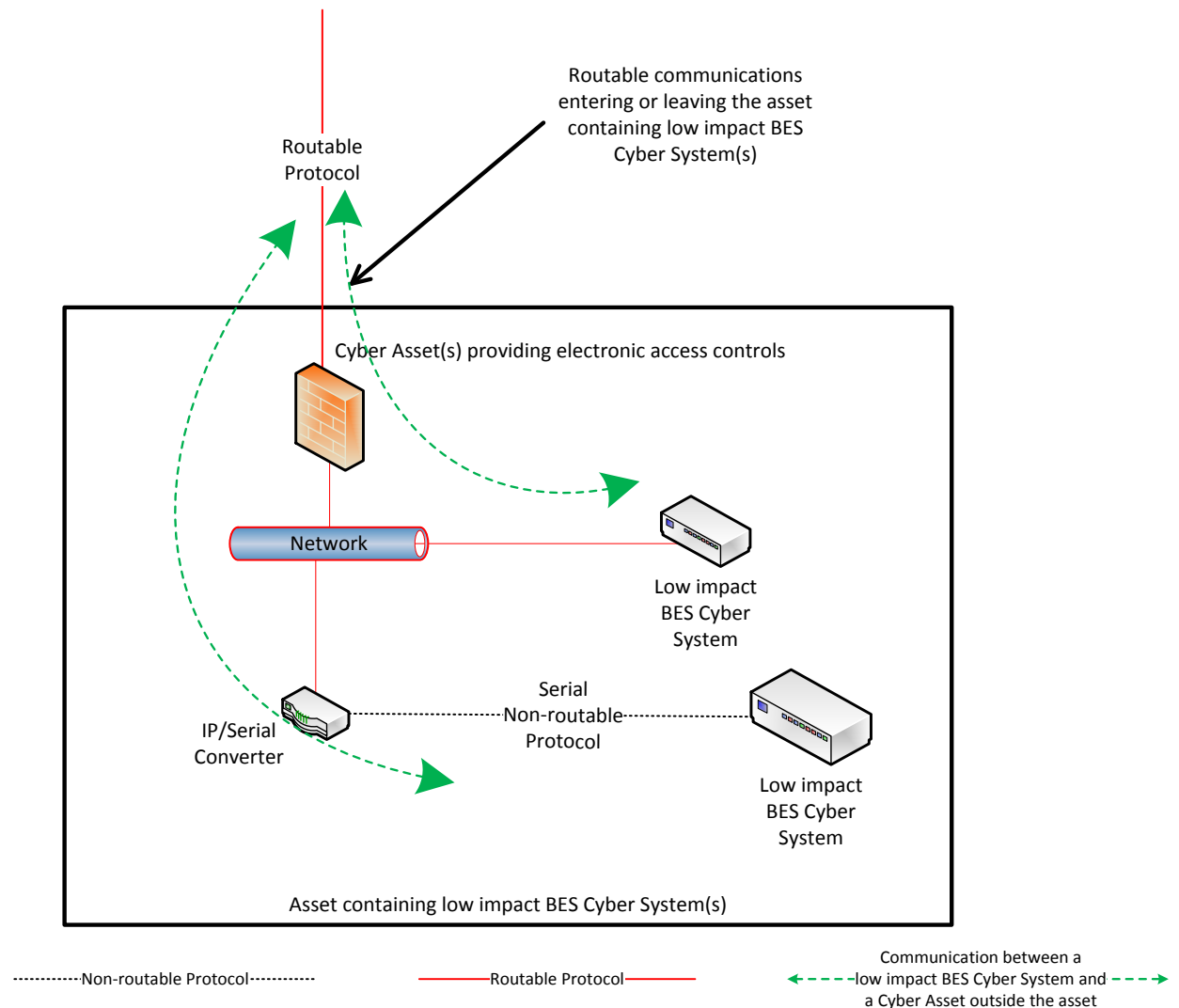

Reference Model 2

### Reference Model 3 – Centralized Network-based Inbound & Outbound Access Permissions

The Responsible Entity may choose to utilize a security device at a centralized location that may or may not be at another asset containing low impact BES Cyber System(s). The electronic access control(s) do not necessarily have to reside inside the asset containing the low impact BES Cyber System(s). A security device is in place at “Location X” to act as the electronic access control and permit only necessary inbound and outbound routable protocol access between the low impact BES Cyber System(s) and the Cyber Asset(s) outside each asset containing low impact BES Cyber System(s). Care should be taken that electronic access to or between each asset is through the Cyber Asset(s) determined by the Responsible Entity to be performing electronic access controls at the centralized location. When permitting the inbound and outbound electronic access permissions using access control lists, the Responsible Entity could restrict communication(s) using source and destination addresses or ranges of addresses. Responsible Entities could also restrict communication(s) using ports or services based on the capability of the electronic access control, the low impact BES Cyber System(s), or the application(s).

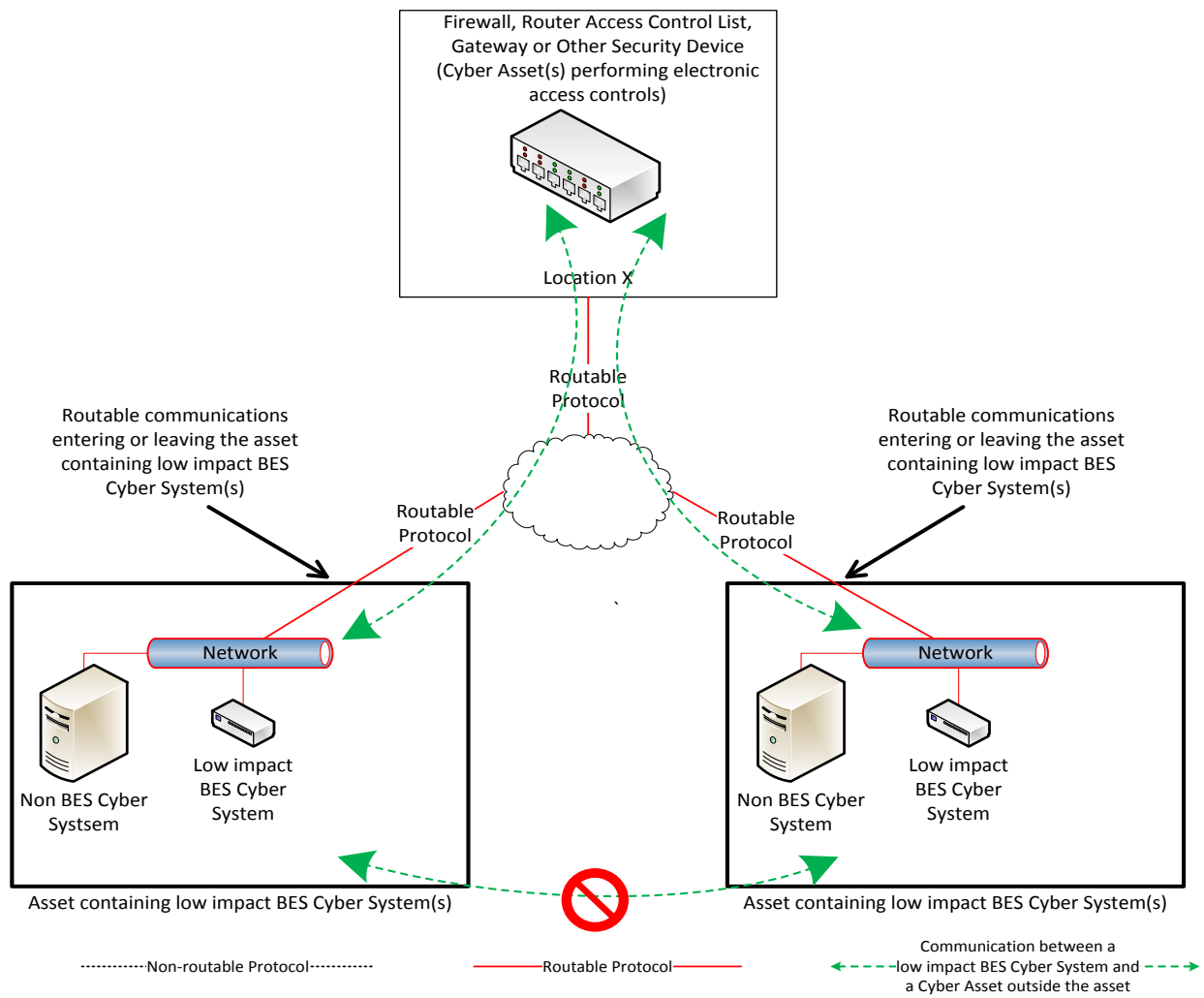

### Reference Model 4 – Uni-directional Gateway

The Responsible Entity may choose to utilize a uni-directional gateway as the electronic access control. The low impact BES Cyber System(s) is not accessible (data cannot flow into the low impact BES Cyber System) using the routable protocol entering the asset due to the implementation of a “one-way” (uni-directional) path for data to flow. The uni-directional gateway is configured to permit only the necessary outbound communications using the routable protocol communication leaving the asset.

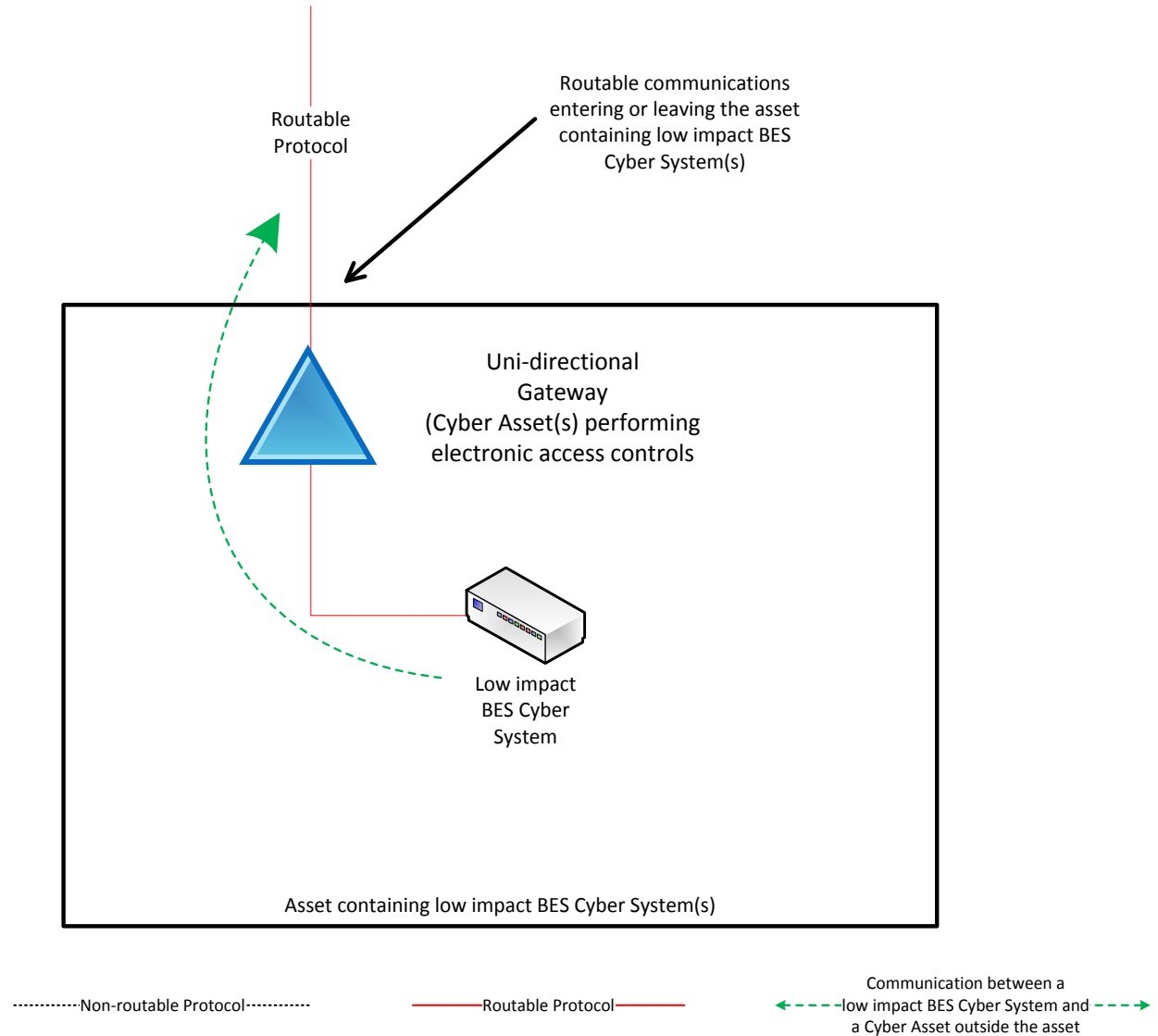

Reference Model 4

**Reference Model 5 – User Authentication**

This reference model demonstrates that Responsible Entities have flexibility in choosing electronic access controls so long as the security objective of the requirement is met. The Responsible Entity may choose to utilize a non-BES Cyber Asset located at the asset containing the low impact BES Cyber System that requires authentication for communication from the Cyber Asset(s) outside the asset. This non-BES Cyber System performing the authentication permits only authenticated communication to connect to the low impact BES Cyber System(s), meeting the first half of the security objective to permit only necessary inbound electronic access. Additionally, the non-BES Cyber System performing authentication is configured such that it permits only necessary outbound communication meeting the second half of the security objective. Often, the outbound communications would be controlled in this network architecture by permitting no communication to be initiated from the low impact BES Cyber System. This configuration may be beneficial when the only communication to a device is for user-initiated interactive access.

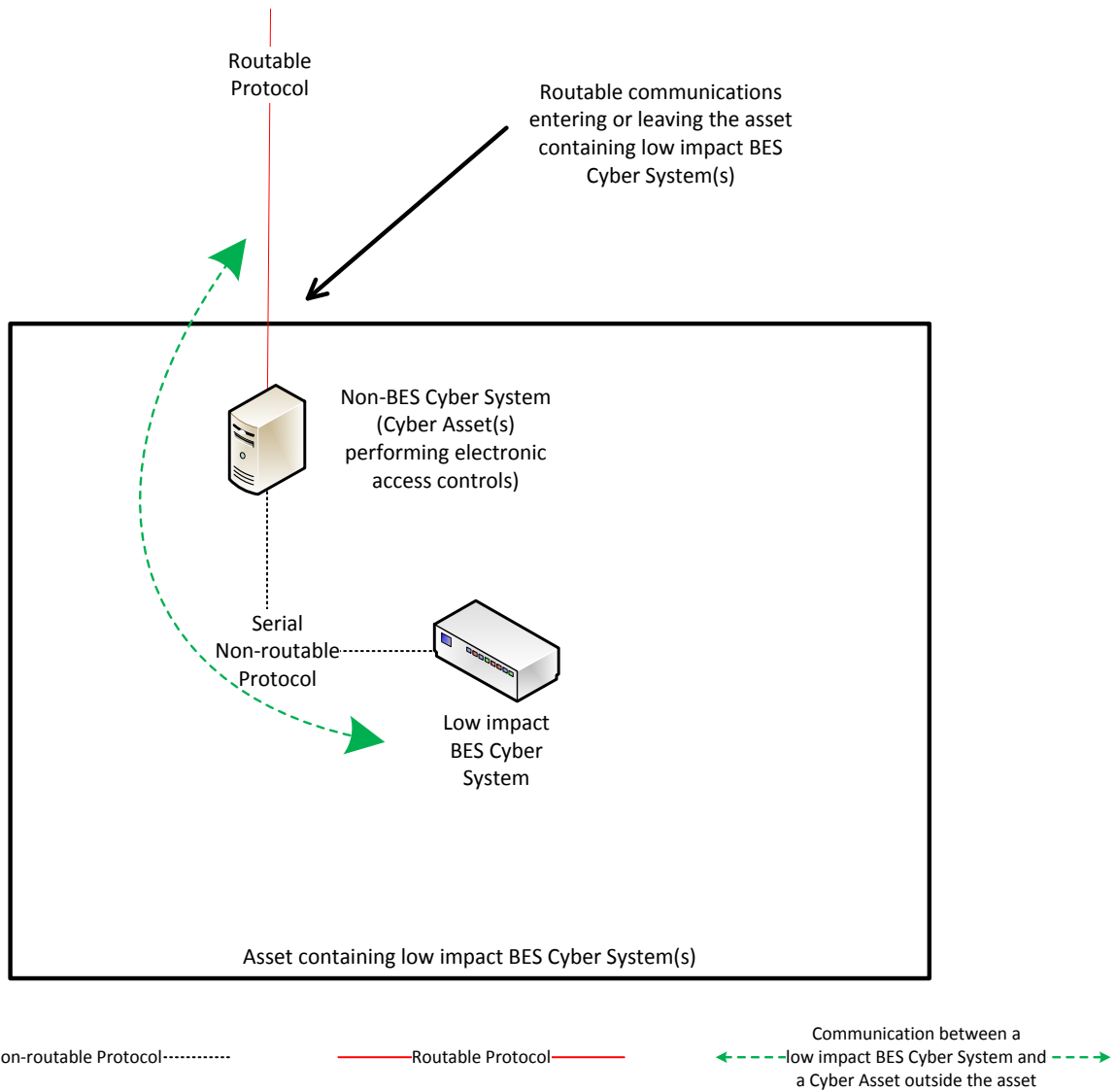

*Reference Model 5*

### Reference Model 6 – Indirect Access

In implementing its electronic access controls, the Responsible Entity may identify that it has indirect access between the low impact BES Cyber System and a Cyber Asset outside the asset containing the low impact BES Cyber System through a non-BES Cyber Asset located within the asset. This indirect access meets the criteria of having communication between the low impact BES Cyber System and a Cyber Asset outside the asset containing the low impact BES Cyber System. In this reference model, it is intended that the Responsible Entity implement electronic access controls that permit only necessary inbound and outbound electronic access to the low impact BES Cyber System. Consistent with the other reference models provided, the electronic access in this reference model is controlled using the security device that is restricting the communication that is entering or leaving the asset.

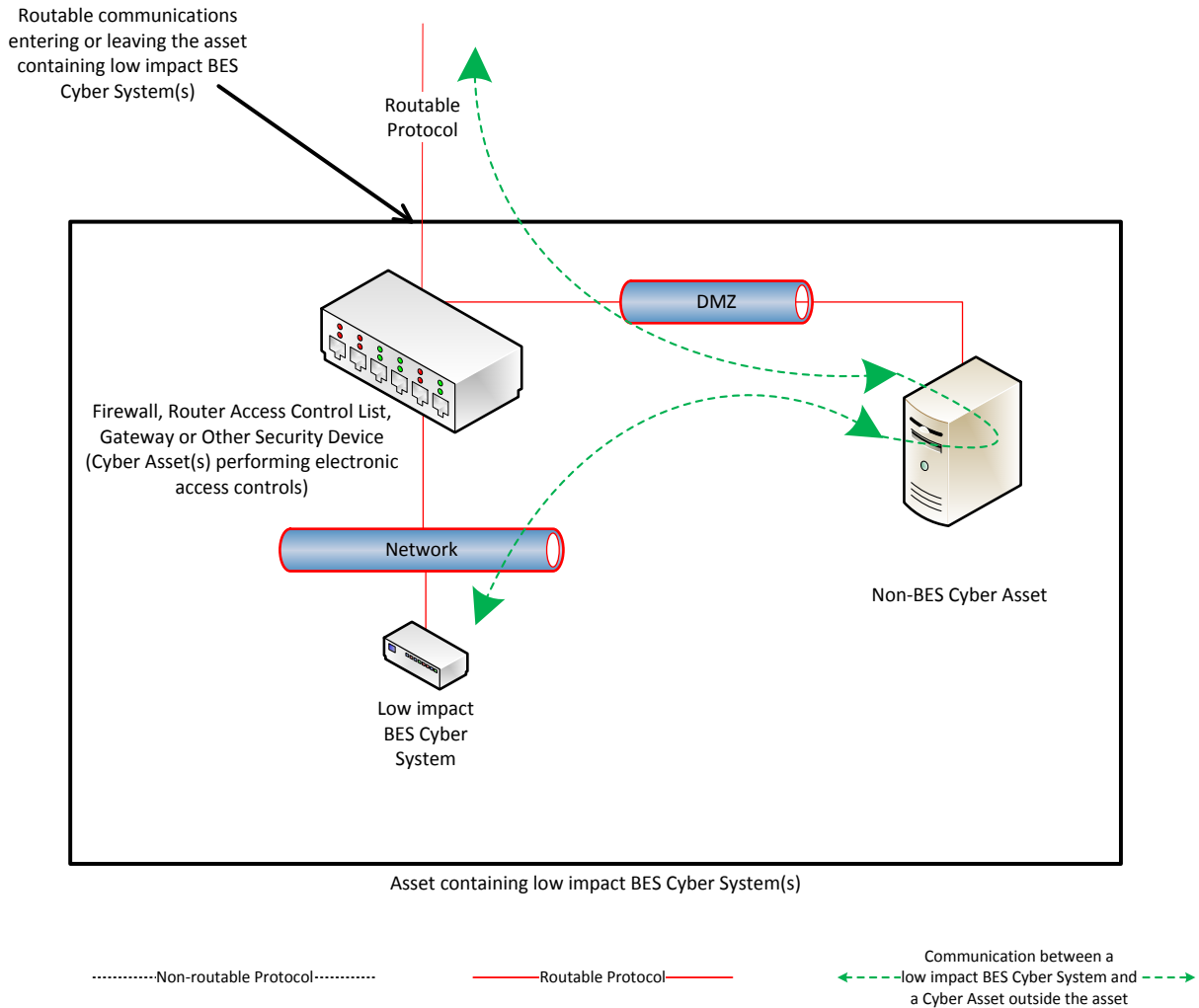

Reference Model 6



### Reference Model 7 – Electronic Access Controls at assets containing low impact BES Cyber Systems and ERC

In this reference model, there is both a routable protocol entering and leaving the asset containing the low impact BES Cyber System(s) that is used by Cyber Asset(s) outside the asset and External Routable Connectivity because there is at least one medium impact BES Cyber System and one low impact BES Cyber System within the asset using the routable protocol communications. The Responsible Entity may choose to leverage an interface on the medium impact Electronic Access Control or Monitoring Systems (EACMS) to provide electronic access controls for purposes of CIP-003. The EACMS is therefore performing multiple functions – as a medium impact EACMS and as implementing electronic access controls for an asset containing low impact BES Cyber Systems.

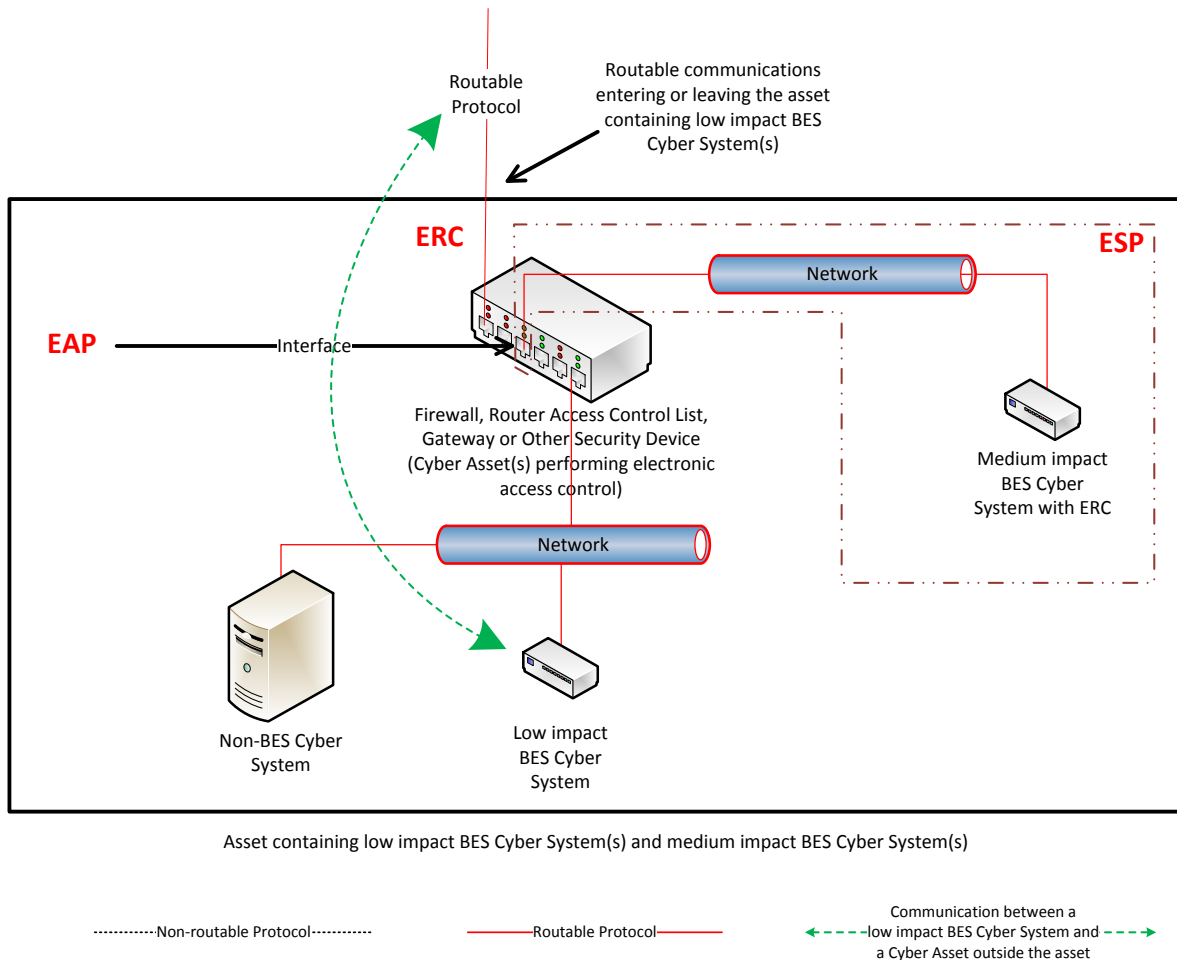

Reference Model 7

**Reference Model 8 – Physical Isolation and Serial Non-routable Communications – No Electronic Access Controls Required**

In this reference model, the criteria from Attachment 1, Section 3.1 requiring the implementation of electronic access controls are not met. This reference model demonstrates three concepts:

- 1) The physical isolation of the low impact BES Cyber System(s) from the routable protocol communication entering or leaving the asset containing the low impact BES Cyber System(s), commonly referred to as an 'air gap', mitigates the need to implement the required electronic access controls;
- 2) The communication to the low impact BES Cyber System from a Cyber Asset outside the asset containing the low impact BES Cyber System(s) using only a serial non-routable protocol where such communication is entering or leaving the asset mitigates the need to implement the required electronic access controls.
- 3) The routable protocol communication between the low impact BES Cyber System(s) and other Cyber Asset(s), such as the second low impact BES Cyber System depicted, may exist without needing to implement the required electronic access controls so long as the routable protocol communications never leaves the asset containing the low impact BES Cyber System(s).

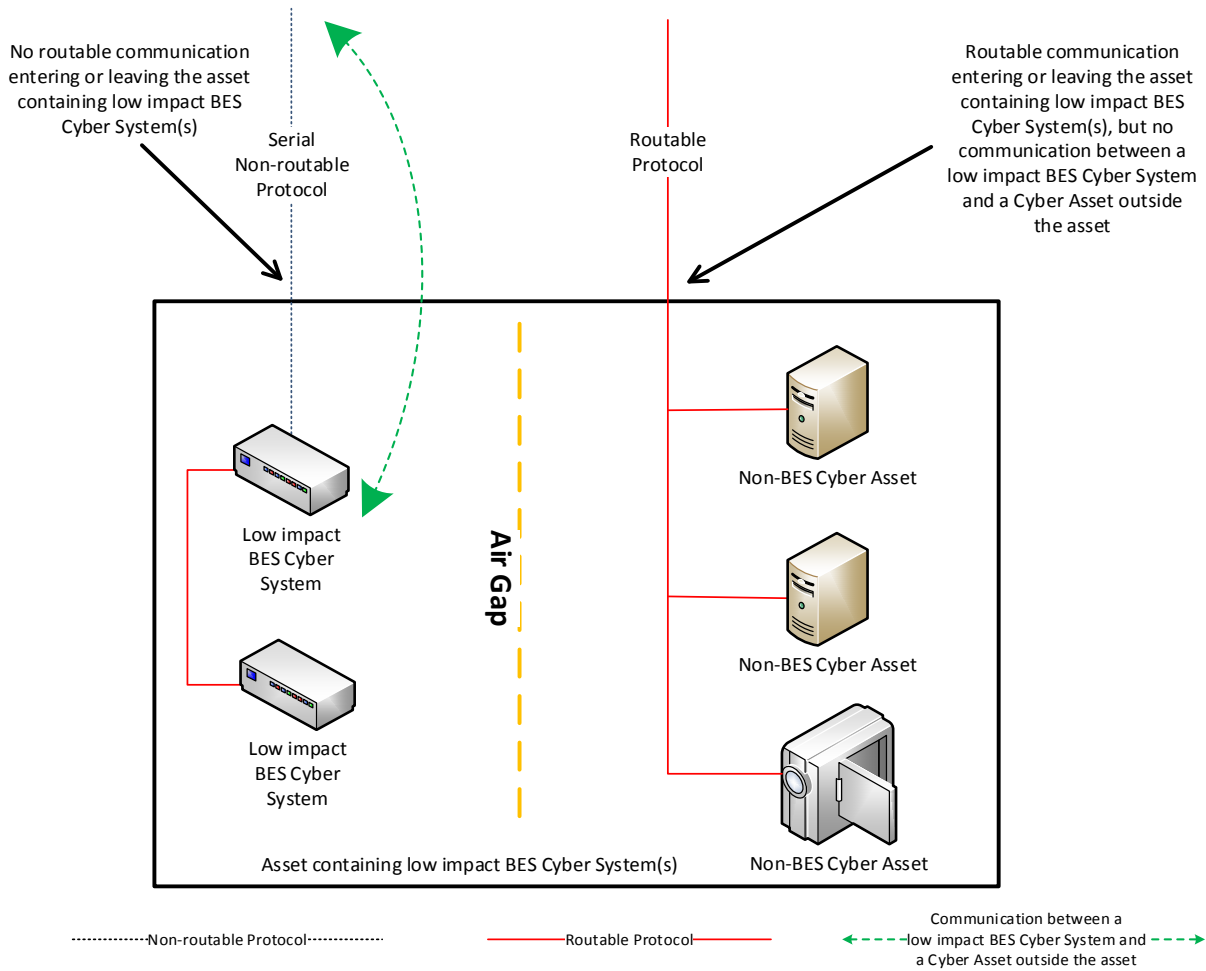

Reference Model 8

**Reference Model 9 – Logical Isolation - No Electronic Access Controls Required**

In this reference model, the criteria from Attachment 1, Section 3.1 requiring the implementation of electronic access controls are not met. The Responsible Entity has logically isolated the low impact BES Cyber System(s) from the routable protocol communication entering or leaving the asset containing low impact BES Cyber System(s). The logical network segmentation in this reference model permits no communication between a low impact BES Cyber System and a Cyber Asset outside the asset. Additionally, no indirect access exists because those non-BES Cyber Assets that are able to communicate outside the asset are strictly prohibited from communicating to the low impact BES Cyber System(s). The low impact BES Cyber System(s) is on an isolated network segment with logical controls preventing routable protocol communication into or out of the network containing the low impact BES Cyber System(s) and these communications never leave the asset using a routable protocol.

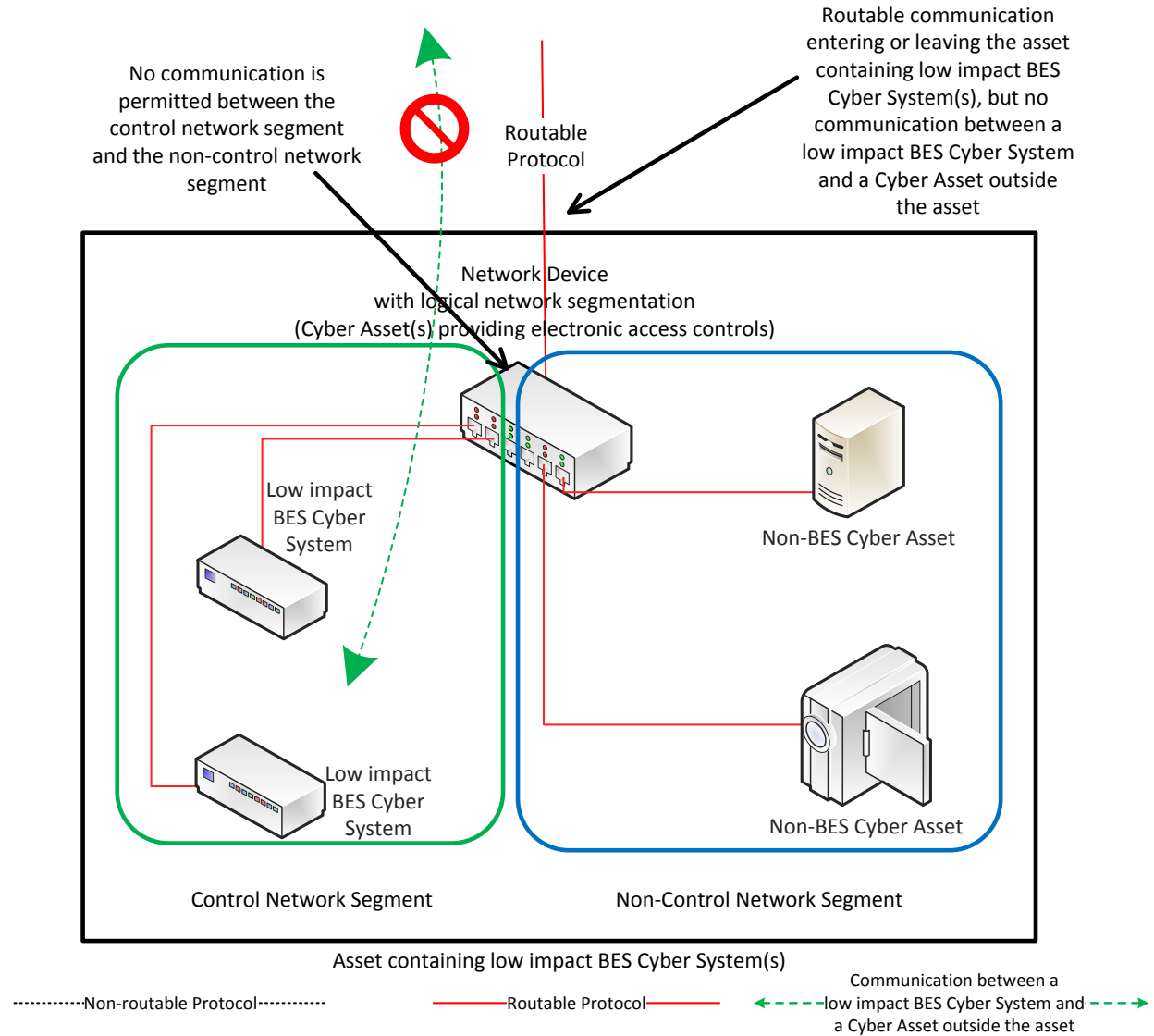

Reference Model 9

**Reference Model 10 - Serial Non-routable Communications Traversing an Isolated Channel on a Non-routable Transport Network – No Electronic Access Controls Required**

In this reference model, the criteria from Attachment 1, Section 3.1 requiring the implementation of electronic access controls are not met. This reference model depicts communication between a low impact BES Cyber System and a Cyber Asset outside the asset containing the low impact BES Cyber System over a serial non-routable protocol which is transported across a wide-area network using a protocol independent transport that may carry routable and non-routable communication such as a Time-Division Multiplexing (TDM) network, a Synchronous Optical Network (SONET), or a Multiprotocol Label Switching (MPLS) network. While there is routable protocol communication entering or leaving the asset containing low impact BES Cyber Systems(s) and there is communication between a low impact BES Cyber System and a Cyber Asset outside the asset, the communication between the low impact BES Cyber System and the Cyber Asset outside the asset is not using the routable protocol communication. This model is related to Reference Model 9 in that it relies on logical isolation to prohibit the communication between a low impact BES Cyber System and a Cyber Asset outside the asset from using a routable protocol.

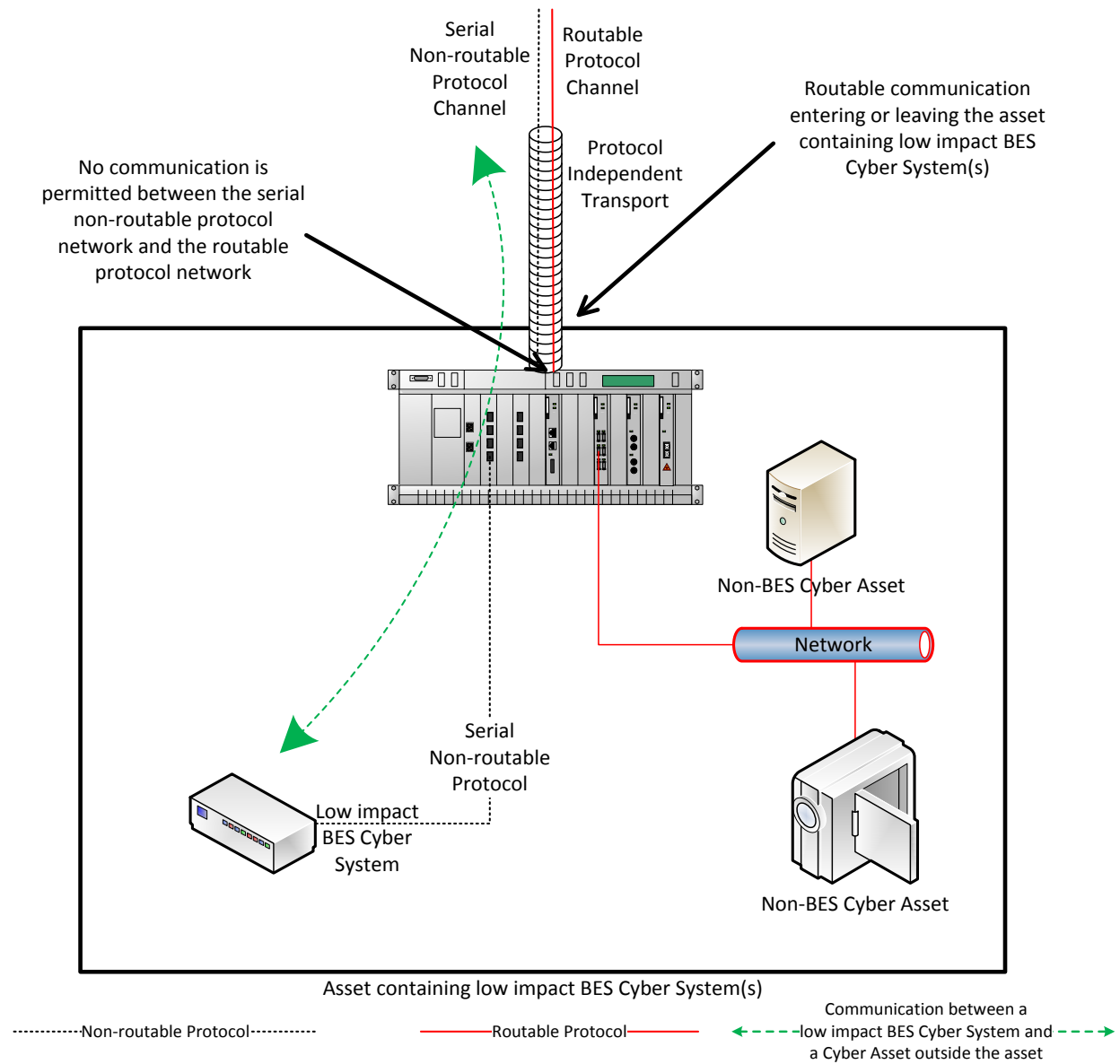

Reference Model 10

### Dial-up Connectivity

Dial-up Connectivity to a low impact BES Cyber System is set to dial out only (no auto-answer) to a preprogrammed number to deliver data. Incoming Dial-up Connectivity is to a dialback modem, a modem that must be remotely controlled by the control center or control room, has some form of access control, or the low impact BES Cyber System has access control.

### Insufficient Access Controls

Some examples of situations that would lack sufficient access controls to meet the intent of this requirement include:

- An asset has Dial-up Connectivity and a low impact BES Cyber System is reachable via an auto-answer modem that connects any caller to the Cyber Asset that has a default password. There is no practical access control in this instance.
- A low impact BES Cyber System has a wireless card on a public carrier that allows the BES Cyber System to be reachable via a public IP address. In essence, low impact BES Cyber Systems should not be accessible from the Internet and search engines such as Shodan.
- Dual-homing or multiple-network interface cards without disabling IP forwarding in the non-BES Cyber Asset within the DMZ to provide separation between the low impact BES Cyber System(s) and the external network would not meet the intent of “controlling” inbound and outbound electronic access assuming there was no other host-based firewall or other security devices on the non-BES Cyber Asset.

### Requirement R2, Attachment 1, Section 4 – Cyber Security Incident Response

The entity should have one or more documented Cyber Security Incident response plan(s) that include each of the topics listed in Section 4. If, in the normal course of business, suspicious activities are noted at an asset containing low impact BES Cyber System(s), the intent is for the entity to implement a Cyber Security Incident response plan that will guide the entity in responding to the incident and reporting the incident if it rises to the level of a Reportable Cyber Security Incident.

Entities are provided the flexibility to develop their Attachment 1, Section 4 Cyber Security Incident response plan(s) by asset or group of assets. The plans do not need to be on a per asset site or per low impact BES Cyber System basis. Entities can choose to use a single enterprise-wide plan to fulfill the obligations for low impact BES Cyber Systems.

The plan(s) must be tested once every 36 months. This is not an exercise per low impact BES Cyber Asset or per type of BES Cyber Asset but rather is an exercise of each incident response plan the entity created to meet this requirement. An actual Reportable Cyber Security Incident counts as an exercise as do other forms of tabletop exercises or drills. NERC-led exercises such as GridEx participation would also count as an exercise provided the entity’s response plan is followed. The intent of the requirement is for entities to keep the Cyber Security Incident response plan(s) current, which includes updating the plan(s), if needed, within 180 days following a test or an actual incident.

For low impact BES Cyber Systems, the only portion of the definition of Cyber Security Incident that would apply is, “A malicious act or suspicious event that disrupts, or was an attempt to



disrupt, the operation of a BES Cyber System.” The other portion of that definition is not to be used to require ESPs and PSPs for low impact BES Cyber Systems.

**Requirement R2, Attachment 1, Section 5 – Transient Cyber Assets and Removable Media Malicious Code Risk Mitigation**

Most BES Cyber Assets and BES Cyber Systems are isolated from external public or untrusted networks, and therefore Transient Cyber Assets and Removable Media are needed to transport files to and from secure areas to maintain, monitor, or troubleshoot critical systems. Transient Cyber Assets and Removable Media are a potential means for cyber-attack. To protect the BES Cyber Assets and BES Cyber Systems, CIP-003 Requirement R2, Attachment 1, Section 5 requires Responsible Entities to document and implement a plan for how they will mitigate the risk of malicious code introduction to low impact BES Cyber Systems from Transient Cyber Assets and Removable Media. The approach of defining a plan allows the Responsible Entity to document processes that are supportable within its organization and in alignment with its change management processes.

Transient Cyber Assets can be one of many types of devices from a specially-designed device for maintaining equipment in support of the BES to a platform such as a laptop, desktop, or tablet that may interface with or run applications that support BES Cyber Systems and is capable of transmitting executable code to the BES Cyber Asset(s) or BES Cyber System(s). Note: Cyber Assets connected to a BES Cyber System for less than 30 days due to an unplanned removal, such as premature failure, are not intended to be identified as Transient Cyber Assets. Removable Media subject to this requirement include, among others, floppy disks, compact disks, USB flash drives, external hard drives, and other flash memory cards/drives that contain nonvolatile memory.

Examples of these temporarily connected devices include, but are not limited to:

- Diagnostic test equipment;
- Equipment used for BES Cyber System maintenance; or
- Equipment used for BES Cyber System configuration.

To meet the objective of mitigating risks associated with the introduction of malicious code at low impact BES Cyber Systems, Section 5 specifies the capabilities and possible security methods available to Responsible Entities based upon asset type and ownership.

With the list of options provided in Attachment 1, the entity has the discretion to use the option(s) that is most appropriate. This includes documenting its approach for how and when the entity reviews the Transient Cyber Asset under its control or under the control of parties other than the Responsible Entity. The entity should avoid implementing a security function that jeopardizes reliability by taking actions that would negatively impact the performance or support of the Transient Cyber Asset or BES Cyber Asset.

### Malicious Code Risk Mitigation

The terms “mitigate”, “mitigating”, and “mitigation” are used in Section 5 in Attachment 1 to address the risks posed by malicious code when connecting Transient Cyber Assets and Removable Media to BES Cyber Systems. Mitigation is intended to mean that entities reduce security risks presented by connecting the Transient Cyber Asset or Removable Media. When determining the method(s) to mitigate the introduction of malicious code, it is not intended for entities to perform and document a formal risk assessment associated with the introduction of malicious code.

### Per Transient Cyber Asset Capability

As with other CIP standards, the requirements are intended for an entity to use the method(s) that the system is capable of performing. The use of “per Transient Cyber Asset capability” is to eliminate the need for a Technical Feasibility Exception when it is understood that the device cannot use a method(s). For example, for malicious code, many types of appliances are not capable of implementing antivirus software; therefore, because it is not a capability of those types of devices, implementation of the antivirus software would not be required for those devices.

### **Requirement R2, Attachment 1, Section 5.1 - Transient Cyber Asset(s) Managed by the Responsible Entity**

For Transient Cyber Assets and Removable Media that are connected to both low impact and medium/high impact BES Cyber Systems, entities must be aware of the differing levels of requirements and manage these assets under the program that matches the highest impact level to which they will connect.

**Section 5.1:** Entities are to document and implement their plan(s) to mitigate malicious code through the use of one or more of the protective measures listed, based on the capability of the Transient Cyber Asset.

The Responsible Entity has the flexibility to apply the selected method(s) to meet the objective of mitigating the introductions of malicious code either in an on-going or in an on-demand manner. An example of managing a device in an on-going manner is having the antivirus solution for the device managed as part of an end-point security solution with current signature or pattern updates, regularly scheduled systems scans, etc. In contrast, for devices that are used infrequently and the signatures or patterns are not kept current, the entity may manage those devices in an on-demand manner by requiring an update to the signatures or patterns and a scan of the device before the device is connected to ensure that it is free of malicious code.

Selecting management in an on-going or on-demand manner is not intended to imply that the control has to be verified at every single connection. For example, if the device is managed in an on-demand manner, but will be used to perform maintenance on several BES Cyber Asset(s), the Responsible Entity may choose to document that the Transient Cyber Asset has been updated before being connected as a Transient Cyber Asset for the first use of that maintenance work. The intent is not to require a log documenting each connection of a Transient Cyber Asset to a BES Cyber Asset.

The following is additional discussion of the methods to mitigate the introduction of malicious code.

- Antivirus software, including manual or managed updates of signatures or patterns, provides flexibility to manage Transient Cyber Asset(s) by deploying antivirus or endpoint security tools that maintain a scheduled update of the signatures or patterns. Also, for devices that do not regularly connect to receive scheduled updates, entities may choose to update the signatures or patterns and scan the Transient Cyber Asset prior to connection to ensure no malicious software is present.
- Application whitelisting is a method of authorizing only the applications and processes that are necessary on the Transient Cyber Asset. This reduces the risk that malicious software could execute on the Transient Cyber Asset and impact the BES Cyber Asset or BES Cyber System.
- When using methods other than those listed, entities need to document how the other method(s) meet the objective of mitigating the risk of the introduction of malicious code.

If malicious code is discovered on the Transient Cyber Asset, it must be mitigated prior to connection to a BES Cyber System to prevent the malicious code from being introduced into the BES Cyber System. An entity may choose to not connect the Transient Cyber Asset to a BES Cyber System to prevent the malicious code from being introduced into the BES Cyber System. Entities should also consider whether the detected malicious code is a Cyber Security Incident.

### **Requirement R2, Attachment 1, Section 5.2 - Transient Cyber Asset(s) Managed by a Party Other than the Responsible Entity**

Section 5 also recognizes the lack of direct control over Transient Cyber Assets that are managed by parties other than the Responsible Entity. This lack of control, however, does not obviate the Responsible Entity's responsibility to ensure that methods have been deployed to mitigate the introduction of malicious code to low impact BES Cyber System(s) from Transient Cyber Assets it does not manage. Section 5 requires entities to review the other party's security practices with respect to Transient Cyber Assets to help meet the objective of the requirement. The use of "prior to connecting the Transient Cyber Assets" is intended to ensure that the Responsible Entity conducts the review before the first connection of the Transient Cyber Asset to help meet the objective to mitigate the introduction of malicious code. The SDT does not intend for the Responsible Entity to conduct a review for every single connection of that Transient Cyber Asset once the Responsible Entity has established the Transient Cyber Asset is meeting the security objective. The intent is to not require a log documenting each connection of a Transient Cyber Asset to a BES Cyber Asset.

To facilitate these controls, Responsible Entities may execute agreements with other parties to provide support services to BES Cyber Systems and BES Cyber Assets that may involve the use of Transient Cyber Assets. Entities may consider using the Department of Energy Cybersecurity Procurement Language for Energy Delivery dated April 2014.<sup>1</sup> Procurement language may unify

---

<sup>1</sup> <http://www.energy.gov/oe/downloads/cybersecurity-procurement-language-energy-delivery-april-2014>

the other party and entity actions supporting the BES Cyber Systems and BES Cyber Assets. CIP program attributes may be considered including roles and responsibilities, access controls, monitoring, logging, vulnerability, and patch management along with incident response and back up recovery may be part of the other party's support. Entities may consider the "General Cybersecurity Procurement Language" and "The Supplier's Life Cycle Security Program" when drafting Master Service Agreements, Contracts, and the CIP program processes and controls.

**Section 5.2.1:** Entities are to document and implement their process(es) to mitigate the introduction of malicious code through the use of one or more of the protective measures listed.

- Review the use of antivirus software and signature or pattern levels to ensure that the level is adequate to the Responsible Entity to mitigate the risk of malicious software being introduced to an applicable system.
- Review the antivirus or endpoint security processes of the other party to ensure that their processes are adequate to the Responsible Entity to mitigate the risk of introducing malicious software to an applicable system.
- Review the use of application whitelisting used by the other party to mitigate the risk of introducing malicious software to an applicable system.
- Review the use of live operating systems or software executable only from read-only media to ensure that the media is free from malicious software itself. Entities should review the processes to build the read-only media as well as the media itself.
- Review system hardening practices used by the other party to ensure that unnecessary ports, services, applications, etc. have been disabled or removed. This method intends to reduce the attack surface on the Transient Cyber Asset and reduce the avenues by which malicious software could be introduced.

**Section 5.2.2:** The intent of this section is to ensure that after conducting the selected review from Section 5.2.1, if there are deficiencies identified, actions mitigating the risk of the introduction of malicious code to low impact BES Cyber Systems must be completed prior to connecting the device(s) to an applicable system.

### **Requirement R2, Attachment 1, Section 5.3 - Removable Media**

Entities have a high level of control for Removable Media that are going to be connected to their BES Cyber Assets.

**Section 5.3:** Entities are to document and implement their process(es) to mitigate the introduction of malicious code through the use of one or more method(s) to detect malicious code on the Removable Media before it is connected to a BES Cyber Asset. When using the method(s) to detect malicious code, it is expected to occur from a system that is not part of the BES Cyber System to reduce the risk of propagating malicious code into the BES Cyber System

network or onto one of the BES Cyber Assets. If malicious code is discovered, it must be removed or mitigated to prevent it from being introduced into the BES Cyber Asset or BES Cyber System. Entities should also consider whether the detected malicious code is a Cyber Security Incident. Frequency and timing of the methods used to detect malicious code were intentionally excluded from the requirement because there are multiple timing scenarios that can be incorporated into a plan to mitigate the risk of malicious code. The SDT does not intend to obligate a Responsible Entity to conduct a review for every single connection of Removable Media, but rather to implement its plan(s) in a manner that protects all BES Cyber Systems where Removable Media may be used. The intent is to not require a log documenting each connection of Removable Media to a BES Cyber Asset.

As a method to detect malicious code, entities may choose to use Removable Media with on-board malicious code detection tools. For these tools, the Removable Media are still used in conjunction with a Cyber Asset to perform the detection. For Section 5.3.1, the Cyber Asset used to perform the malicious code detection must be outside of the BES Cyber System.

### **Requirement R3:**

The intent of CIP-003-8, Requirement R3 is effectively unchanged since prior versions of the standard. The specific description of the CIP Senior Manager has now been included as a defined term rather than clarified in the Reliability Standard itself to prevent any unnecessary cross-reference to this standard. It is expected that the CIP Senior Manager will play a key role in ensuring proper strategic planning, executive/board-level awareness, and overall program governance.

### **Requirement R4:**

As indicated in the rationale for CIP-003-8, Requirement R4, this requirement is intended to demonstrate a clear line of authority and ownership for security matters. The intent of the SDT was not to impose any particular organizational structure, but, rather, the intent is to afford the Responsible Entity significant flexibility to adapt this requirement to its existing organizational structure. A Responsible Entity may satisfy this requirement through a single delegation document or through multiple delegation documents. The Responsible Entity can make use of the delegation of the delegation authority itself to increase the flexibility in how this applies to its organization. In such a case, delegations may exist in numerous documentation records as long as the collection of these documentation records shows a clear line of authority back to the CIP Senior Manager. In addition, the CIP Senior Manager could also choose not to delegate any authority and meet this requirement without such delegation documentation.

The Responsible Entity must keep its documentation of the CIP Senior Manager and any delegations up-to-date. This is to ensure that individuals do not assume any undocumented authority. However, delegations do not have to be re-instated if the individual who delegated the task changes roles or the individual is replaced. For instance, assume that John Doe is named the CIP Senior Manager and he delegates a specific task to the Substation Maintenance Manager. If John Doe is replaced as the CIP Senior Manager, the CIP Senior Manager documentation must be updated within the specified timeframe, but the existing delegation to

the Substation Maintenance Manager remains in effect as approved by the previous CIP Senior Manager, John Doe.

### **Rationale:**

During development of this standard, text boxes were embedded within the standard to explain the rationale for various parts of the standard. Upon BOT approval, the text from the rationale text boxes was moved to this section.

### **Rationale for Requirement R1:**

One or more security policies enable effective implementation of the requirements of the cyber security Reliability Standards. The purpose of policies is to provide a management and governance foundation for all requirements that apply to a Responsible Entity's BES Cyber Systems. The Responsible Entity can demonstrate through its policies that its management supports the accountability and responsibility necessary for effective implementation of the requirements.

Annual review and approval of the cyber security policies ensures that the policies are kept-up-to-date and periodically reaffirms management's commitment to the protection of its BES Cyber Systems.

### **Rationale for Requirement R2:**

In response to FERC Order No. 791, Requirement R2 requires entities to develop and implement cyber security plans to meet specific security control objectives for assets containing low impact BES Cyber System(s). The cyber security plan(s) covers five subject matter areas: (1) cyber security awareness; (2) physical security controls; (3) electronic access controls; (4) Cyber Security Incident response; and (5) Transient Cyber Asset and Removable Media Malicious Code Risk Mitigation. This plan(s), along with the cyber security policies required under Requirement R1, Part 1.2, provides a framework for operational, procedural, and technical safeguards for low impact BES Cyber Systems.

Considering the varied types of low impact BES Cyber Systems across the BES, Attachment 1 provides Responsible Entities flexibility on how to apply the security controls to meet the security objectives. Additionally, because many Responsible Entities have multiple-impact rated BES Cyber Systems, nothing in the requirement prohibits entities from using their high and medium impact BES Cyber System policies, procedures, and processes to implement security controls required for low impact BES Cyber Systems, as detailed in Requirement R2, Attachment 1.

Responsible Entities will use their identified assets containing low impact BES Cyber System(s) (developed pursuant to CIP-002) to substantiate the sites or locations associated with low impact BES Cyber System(s). However, there is no requirement or compliance expectation for Responsible Entities to maintain a list(s) of individual low impact BES Cyber System(s) and their associated cyber assets or to maintain a list of authorized users.

### **Rationale for Modifications to Sections 2 and 3 of Attachment 1 (Requirement R2):**

Requirement R2 mandates that entities develop and implement one or more cyber security plan(s) to meet specific security objectives for assets containing low impact BES Cyber System(s). In Paragraph 73 of FERC Order No. 822, the Commission directed NERC to modify "...the Low Impact External Routable Connectivity definition to reflect the commentary in the Guidelines and Technical Basis section of CIP-003-6...to provide needed clarity to the definition



and eliminate ambiguity surrounding the term ‘direct’ as it is used in the proposed definition...within one year of the effective date of this Final Rule.”

The revisions to Section 3 incorporate select language from the LERC definition into Attachment 1 and focus the requirement on implementing electronic access controls for asset(s) containing low impact BES Cyber System(s). This change requires the Responsible Entity to permit only necessary inbound and outbound electronic access when using a routable protocol entering or leaving the asset between low impact BES Cyber System(s) and a Cyber Asset(s) outside the asset containing low impact BES Cyber system(s). When this communication is present, Responsible Entities are required to implement electronic access controls unless that communication meets the following exclusion language (previously in the definition of LERC) contained in romanette (iii): “not used for time-sensitive protection or control functions between intelligent electronic devices (e.g. communications using protocol IEC TR-61850-90-5 R-GOOSE)”.

The revisions to Section 2 of Attachment 1 complement the revisions to Section 3; consequently, the requirement now mandates the Responsible Entity control physical access to “the Cyber Asset(s), as specified by the Responsible Entity, that provide electronic access control(s) implemented for Section 3.1, if any.” The focus on electronic access controls rather than on the Low Impact BES Cyber System Electronic Access Points (LEAPs) eliminates the need for LEAPs.

Given these revisions to Sections 2 and 3, the NERC Glossary terms: Low Impact External Routable Connectivity (LERC) and Low Impact BES Cyber System Electronic Access Point (LEAP) will be retired.

### **Rationale for Section 5 of Attachment 1 (Requirement R2):**

Requirement R2 mandates that entities develop and implement one or more cyber security plan(s) to meet specific security objectives for assets containing low impact BES Cyber System(s). In Paragraph 32 of FERC Order No. 822, the Commission directed NERC to “...provide mandatory protection for transient devices used at Low Impact BES Cyber Systems based on the risk posed to bulk electric system reliability.” Transient devices are potential vehicles for introducing malicious code into low impact BES Cyber Systems. Section 5 of Attachment 1 is intended to mitigate the risk of malware propagation to the BES through low impact BES Cyber Systems by requiring entities to develop and implement one or more plan(s) to address the risk. The cyber security plan(s) along with the cyber security policies required under Requirement R1, Part 1.2, provide a framework for operational, procedural, and technical safeguards for low impact BES Cyber Systems.

### **Rationale for Requirement R3:**

The identification and documentation of the single CIP Senior Manager ensures that there is clear authority and ownership for the CIP program within an organization, as called for in Blackout Report Recommendation 43. The language that identifies CIP Senior Manager responsibilities is included in the Glossary of Terms used in NERC Reliability Standards so that it may be used across the body of CIP standards without an explicit cross-reference.



FERC Order No. 706, Paragraph 296, requests consideration of whether the single senior manager should be a corporate officer or equivalent. As implicated through the defined term, the senior manager has “the overall authority and responsibility for leading and managing implementation of the requirements within this set of standards” which ensures that the senior manager is of sufficient position in the Responsible Entity to ensure that cyber security receives the prominence that is necessary. In addition, given the range of business models for responsible entities, from municipal, cooperative, federal agencies, investor owned utilities, privately owned utilities, and everything in between, the SDT believes that requiring the CIP Senior Manager to be a “corporate officer or equivalent” would be extremely difficult to interpret and enforce on a consistent basis.

### **Rationale for Requirement R4:**

The intent of the requirement is to ensure clear accountability within an organization for certain security matters. It also ensures that delegations are kept up-to-date and that individuals do not assume undocumented authority.

In FERC Order No. 706, Paragraphs 379 and 381, the Commission notes that Recommendation 43 of the 2003 Blackout Report calls for “clear lines of authority and ownership for security matters.” With this in mind, the Standard Drafting Team has sought to provide clarity in the requirement for delegations so that this line of authority is clear and apparent from the documented delegations.

## Standard Development Timeline

This section is maintained by the drafting team during the development of the standard and will be removed when the standard is adopted by the NERC Board of Trustees (Board).

### Description of Current Draft

45-day initial formal comment period with a 10-day final ballot.

<u>Completed Actions</u>	<u>Date</u>
<u>Standards Committee approved Standard Authorization Request (SAR) for posting</u>	<u>June 13, 2018</u>
<u>SAR posted for comment</u>	<u>June 14<del>3</del> – July 13, 2018</u>
<u>45-day formal comment period with ballot (initial)</u>	<u>August 23<del>8</del> – October 9, 2018</u>

<u>Anticipated Actions</u>	<u>Date</u>
<u>45-day formal comment period with ballot (initial)</u>	<u>August 23<del>8</del> – October 9<del>8</del>, 2018</u>
<u>10-day final ballot</u>	<u>April 18 – 29, 2019</u> <u>October 29 – November 8, 2018</u>
<u>Board adoption</u>	<u>February–May 8, 2019</u>

## A. Introduction

1. **Title:** Cyber Security — Security Management Controls
2. **Number:** CIP-003-~~87~~
3. **Purpose:** To specify consistent and sustainable security management controls that establish responsibility and accountability to protect BES Cyber Systems against compromise that could lead to misoperation or instability in the Bulk Electric System (BES).

### ~~3.4.~~ **Applicability:**

~~3.1.4.1.~~ **Functional Entities:** For the purpose of the requirements contained herein, the following list of functional entities will be collectively referred to as “Responsible Entities.” For requirements in this standard where a specific functional entity or subset of functional entities are the applicable entity or entities, the functional entity or entities are specified explicitly.

#### ~~3.1.4.1.1.~~ **Balancing Authority**

~~3.1.2.4.1.2.~~ **Distribution Provider** that owns one or more of the following Facilities, systems, and equipment for the protection or restoration of the BES:

~~3.1.2.1.4.1.2.1.~~ Each underfrequency Load shedding (UFLS) or undervoltage Load shedding (UVLS) system that:

~~3.1.2.1.1.4.1.2.1.1.~~ is part of a Load shedding program that is subject to one or more requirements in a NERC or Regional Reliability Standard; and

~~3.1.2.1.2.4.1.2.1.2.~~ performs automatic Load shedding under a common control system owned by the Responsible Entity, without human operator initiation, of 300 MW or more.

~~3.1.2.2.4.1.2.2.~~ Each ~~Special Protection System (SPS) or~~ Remedial Action Scheme (RAS) where the ~~SPS or~~ RAS is subject to one or more requirements in a NERC or Regional Reliability Standard.

~~3.1.2.3.4.1.2.3.~~ Each Protection System (excluding UFLS and UVLS) that applies to Transmission where the Protection System is subject to one or more requirements in a NERC or Regional Reliability Standard.

~~3.1.2.4.4.1.2.4.~~ Each Cranking Path and group of Elements meeting the initial switching requirements from a Blackstart Resource up to and including the first interconnection point of the starting station service of the next generation unit(s) to be started.

#### ~~3.1.3.4.1.3.~~ **Generator Operator**

#### ~~3.1.4.4.1.4.~~ **Generator Owner**

#### ~~3.1.5.~~ **Interchange Coordinator or Interchange Authority**

~~3.1.6.4.1.5.~~ **Reliability Coordinator**

~~3.1.7.4.1.6.~~ **Transmission Operator**

~~3.1.8.4.1.7.~~ **Transmission Owner**

~~3.2.4.2.~~ **Facilities:** For the purpose of the requirements contained herein, the following Facilities, systems, and equipment owned by each Responsible Entity in Section 4.1 above are those to which these requirements are applicable. For requirements in this standard where a specific type of Facilities, system, or equipment or subset of Facilities, systems, and equipment are applicable, these are specified explicitly.

~~3.2.1.4.2.1.~~ **Distribution Provider:** One or more of the following Facilities, systems and equipment owned by the Distribution Provider for the protection or restoration of the BES:

~~3.2.1.1.4.2.1.1.~~ Each UFLS or UVLS System that:

~~3.2.1.1.1.4.2.1.1.1.~~ is part of a Load shedding program that is subject to one or more requirements in a NERC or Regional Reliability Standard; and

~~3.2.1.1.2.4.2.1.1.2.~~ performs automatic Load shedding under a common control system owned by the Responsible Entity, without human operator initiation, of 300 MW or more.

~~3.2.1.2.4.2.1.2.~~ Each SPS or RAS where the SPS or RAS is subject to one or more requirements in a NERC or Regional Reliability Standard.

~~3.2.1.3.4.2.1.3.~~ Each Protection System (excluding UFLS and UVLS) that applies to Transmission where the Protection System is subject to one or more requirements in a NERC or Regional Reliability Standard.

~~3.2.1.4.4.2.1.4.~~ Each Cranking Path and group of Elements meeting the initial switching requirements from a Blackstart Resource up to and including the first interconnection point of the starting station service of the next generation unit(s) to be started.

~~3.2.2.4.2.2.~~ **Responsible Entities listed in 4.1 other than Distribution Providers:**

All BES Facilities.

~~3.2.3.4.2.3.~~ **Exemptions:** The following are exempt from Standard CIP-003-87:

~~3.2.3.1.4.2.3.1.~~ Cyber Assets at Facilities regulated by the Canadian Nuclear Safety Commission.

~~3.2.3.2.4.2.3.2.~~ Cyber Assets associated with communication networks and data communication links between discrete Electronic Security Perimeters (ESPs).

~~3.2.3.3.4.2.3.3.~~ The systems, structures, and components that are regulated by the Nuclear Regulatory Commission under a cyber security plan pursuant to 10 C.F.R. Section 73.54.

~~3.2.3.4.4.2.3.4.~~ For Distribution Providers, the systems and equipment that are not included in section 4.2.1 above.

**4.5. Effective Dates:**

See Implementation Plan for CIP-003-~~87~~.

**5.6. Background:**

Standard CIP-003 exists as part of a suite of CIP Standards related to cyber security, which require the initial identification and categorization of BES Cyber Systems and require organizational, operational, and procedural controls to mitigate risk to BES Cyber Systems.

The term policy refers to one or a collection of written documents that are used to communicate the Responsible Entities' management goals, objectives and expectations for how the Responsible Entity will protect its BES Cyber Systems. The use of policies also establishes an overall governance foundation for creating a culture of security and compliance with laws, regulations, and standards.

The term documented processes refers to a set of required instructions specific to the Responsible Entity and to achieve a specific outcome. This term does not imply any naming or approval structure beyond what is stated in the requirements. An entity should include as much as it believes necessary in its documented processes, but it must address the applicable requirements.

The terms program and plan are sometimes used in place of documented processes where it makes sense and is commonly understood. For example, documented processes describing a response are typically referred to as plans (i.e., incident response plans and recovery plans). Likewise, a security plan can describe an approach involving multiple procedures to address a broad subject matter.

Similarly, the term program may refer to the organization's overall implementation of its policies, plans, and procedures involving a subject matter. Examples in the standards include the personnel risk assessment program and the personnel training program. The full implementation of the CIP Cyber Security Reliability Standards could also be referred to as a program. However, the terms program and plan do not imply any additional requirements beyond what is stated in the standards.

Responsible Entities can implement common controls that meet requirements for multiple high, medium, and low impact BES Cyber Systems. For example, a single cyber security awareness program could meet the requirements across multiple BES Cyber Systems.

Measures provide examples of evidence to show documentation and implementation of the requirement. These measures serve to provide guidance to entities in acceptable records of compliance and should not be viewed as an all-inclusive list.

Throughout the standards, unless otherwise stated, bulleted items in the requirements and measures are items that are linked with an “or,” and numbered items are items that are linked with an “and.”

Many references in the Applicability section use a threshold of 300 MW for UFLS and UVLS. This particular threshold of 300 MW for UVLS and UFLS was provided in Version 1 of the CIP Cyber Security Standards. The threshold remains at 300 MW since it is specifically addressing UVLS and UFLS, which are last ditch efforts to save the BES. A review of UFLS tolerances defined within Regional Reliability Standards for UFLS program requirements to date indicates that the historical value of 300 MW represents an adequate and reasonable threshold value for allowable UFLS operational tolerances.

## B. Requirements and Measures

- R1.** Each Responsible Entity shall review and obtain CIP Senior Manager approval at least once every 15 calendar months for one or more documented cyber security policies that collectively address the following topics: *[Violation Risk Factor: Medium] [Time Horizon: Operations Planning]*
- 1.1.** For its high impact and medium impact BES Cyber Systems, if any:
    - 1.1.1.** Personnel and training (CIP-004);
    - 1.1.2.** Electronic Security Perimeters (CIP-005) including Interactive Remote Access;
    - 1.1.3.** Physical security of BES Cyber Systems (CIP-006);
    - 1.1.4.** System security management (CIP-007);
    - 1.1.5.** Incident reporting and response planning (CIP-008);
    - 1.1.6.** Recovery plans for BES Cyber Systems (CIP-009);
    - 1.1.7.** Configuration change management and vulnerability assessments (CIP-010);
    - 1.1.8.** Information protection (CIP-011); and
    - 1.1.9.** Declaring and responding to CIP Exceptional Circumstances.
  - 1.2.** For its assets identified in CIP-002 containing low impact BES Cyber Systems, if any:
    - 1.2.1.** Cyber security awareness;
    - 1.2.2.** Physical security controls;
    - 1.2.3.** Electronic access controls;
    - 1.2.4.** Cyber Security Incident response;
    - 1.2.5.** Transient Cyber Assets and Removable Media malicious code risk mitigation; and
    - 1.2.6.** Declaring and responding to CIP Exceptional Circumstances.
- M1.** Examples of evidence may include, but are not limited to, policy documents; revision history, records of review, or workflow evidence from a document management system that indicate review of each cyber security policy at least once every 15 calendar months; and documented approval by the CIP Senior Manager for each cyber security policy.
- R2.** Each Responsible Entity with at least one asset identified in CIP-002 containing low impact BES Cyber Systems shall implement one or more documented cyber security plan(s) for its low impact BES Cyber Systems that include the sections in Attachment 1. *[Violation Risk Factor: Lower] [Time Horizon: Operations Planning]*

Note: An inventory, list, or discrete identification of low impact BES Cyber Systems or their BES Cyber Assets is not required. Lists of authorized users are not required.

- M2.** Evidence shall include each of the documented cyber security plan(s) that collectively include each of the sections in Attachment 1 and additional evidence to demonstrate implementation of the cyber security plan(s). Additional examples of evidence per section are located in Attachment 2.
- R3.** Each Responsible Entity shall identify a CIP Senior Manager by name and document any change within 30 calendar days of the change. *[Violation Risk Factor: Medium]*  
*[Time Horizon: Operations Planning]*
- M3.** An example of evidence may include, but is not limited to, a dated and approved document from a high level official designating the name of the individual identified as the CIP Senior Manager.
- R4.** The Responsible Entity shall implement a documented process to delegate authority, unless no delegations are used. Where allowed by the CIP Standards, the CIP Senior Manager may delegate authority for specific actions to a delegate or delegates. These delegations shall be documented, including the name or title of the delegate, the specific actions delegated, and the date of the delegation; approved by the CIP Senior Manager; and updated within 30 days of any change to the delegation. Delegation changes do not need to be reinstated with a change to the delegator. *[Violation Risk Factor: Lower]* *[Time Horizon: Operations Planning]*
- M4.** An example of evidence may include, but is not limited to, a dated document, approved by the CIP Senior Manager, listing individuals (by name or title) who are delegated the authority to approve or authorize specifically identified items.



## C. Compliance

### 1. Compliance Monitoring Process

#### 1.1. Compliance Enforcement Authority:

As defined in the NERC Rules of Procedure, “Compliance Enforcement Authority” (CEA) means NERC or the Regional Entity in their respective roles of monitoring and enforcing compliance with the NERC Reliability Standards.

Formatted: Space After: 0 pt

#### 1.2. Evidence Retention:

The following evidence retention periods identify the period of time an entity is required to retain specific evidence to demonstrate compliance. For instances where the evidence retention period specified below is shorter than the time since the last audit, the CEA may ask an entity to provide other evidence to show that it was compliant for the full time period since the last audit.

Formatted: Space After: 0 pt

The Responsible Entity shall keep data or evidence to show compliance as identified below unless directed by its CEA to retain specific evidence for a longer period of time as part of an investigation:

- Each Responsible Entity shall retain evidence of each requirement in this standard for three calendar years.
- If a Responsible Entity is found non-compliant, it shall keep information related to the non-compliance until mitigation is complete and approved or for the time specified above, whichever is longer.
- The CEA shall keep the last audit records and all requested and submitted subsequent audit records.

#### 1.3. Compliance Monitoring and Assessment Processes:

- Compliance Audits
- Self-Certifications
- Spot Checking
- Compliance Investigations
- Self-Reporting
- Complaints

#### 1.4. Additional Compliance Information:

None.

Formatted: Space After: 0 pt

**Violation Severity Levels**

**2. Table of Compliance Elements**

R #	Time Horizon	VRF	Violation Severity Levels (CIP-003- <del>87</del> )			
			Lower VSL	Moderate VSL	High VSL	Severe VSL
R1	Operations Planning	Medium	<p>The Responsible Entity documented and implemented one or more cyber security policies for its high impact and medium impact BES Cyber Systems, but did not address one of the nine topics required by R1. (R1.1)</p> <p>OR</p> <p>The Responsible Entity did not complete its review of the one or more documented cyber security policies for its high impact and medium impact BES Cyber Systems as required by R1 within 15 calendar</p>	<p>The Responsible Entity documented and implemented one or more cyber security policies for its high impact and medium impact BES Cyber Systems, but did not address two of the nine topics required by R1. (R1.1)</p> <p>OR</p> <p>The Responsible Entity did not complete its review of the one or more documented cyber security policies for its high impact and medium impact BES Cyber Systems as required by R1 within 16 calendar</p>	<p>The Responsible Entity documented and implemented one or more cyber security policies for its high impact and medium impact BES Cyber Systems, but did not address three of the nine topics required by R1. (R1.1)</p> <p>OR</p> <p>The Responsible Entity did not complete its review of the one or more documented cyber security policies for its high impact and medium impact BES Cyber Systems as required by R1 within 17 calendar months but did complete this review in less than or equal to 18</p>	<p>The Responsible Entity documented and implemented one or more cyber security policies for its high impact and medium impact BES Cyber Systems, but did not address four or more of the nine topics required by R1. (R1.1)</p> <p>OR</p> <p>The Responsible Entity did not have any documented cyber security policies for its high impact and medium impact BES Cyber Systems as required by R1. (R1.1)</p> <p>OR</p>

R #	Time Horizon	VRF	Violation Severity Levels (CIP-003-87)			
			Lower VSL	Moderate VSL	High VSL	Severe VSL
			<p>months but did complete this review in less than or equal to 16 calendar months of the previous review. (R1.1)</p> <p>OR</p> <p>The Responsible Entity did not complete its approval of the one or more documented cyber security policies for its high impact and medium impact BES Cyber Systems as required by R1 by the CIP Senior Manager within 15 calendar months but did complete this approval in less than or equal to 16 calendar months of</p>	<p>months but did complete this review in less than or equal to 17 calendar months of the previous review. (R1.1)</p> <p>OR</p> <p>The Responsible Entity did not complete its approval of the one or more documented cyber security policies for its high impact and medium impact BES Cyber Systems as required by R1 by the CIP Senior Manager within 16 calendar months but did complete this approval in less than or equal to 17 calendar months of</p>	<p>calendar months of the previous review. (R1.1)</p> <p>OR</p> <p>The Responsible Entity did not complete its approval of the one or more documented cyber security policies for its high impact and medium impact BES Cyber Systems as required by R1 by the CIP Senior Manager within 17 calendar months but did complete this approval in less than or equal to 18 calendar months of the previous approval. (R1)</p> <p>OR</p> <p>The Responsible Entity documented one or more cyber security policies for its assets identified in CIP-002 containing low impact</p>	<p>The Responsible Entity did not complete its review of the one or more documented cyber security policies as required by R1 within 18 calendar months of the previous review. (R1)</p> <p>OR</p> <p>The Responsible Entity did not complete its approval of the one or more documented cyber security policies for its high impact and medium impact BES Cyber Systems as required by R1 by the CIP Senior Manager within 18 calendar months of the previous approval. (R1.1)</p>

R #	Time Horizon	VRF	Violation Severity Levels (CIP-003- <del>87</del> )			
			Lower VSL	Moderate VSL	High VSL	Severe VSL
			<p>the previous approval. (R1.1)</p> <p>OR</p> <p>The Responsible Entity documented one or more cyber security policies for its assets identified in CIP-002 containing low impact BES Cyber Systems, but did not address one of the six topics required by R1. (R1.2)</p> <p>OR</p> <p>The Responsible Entity did not complete its review of the one or more documented cyber security policies for its assets identified in CIP-002 containing low impact BES Cyber Systems as</p>	<p>the previous approval. (R1.1)</p> <p>OR</p> <p>The Responsible Entity documented one or more cyber security policies for its assets identified in CIP-002 containing low impact BES Cyber Systems, but did not address two of the six topics required by R1. (R1.2)</p> <p>OR</p> <p>The Responsible Entity did not complete its review of the one or more documented cyber security policies for its assets identified in CIP-002 containing low impact BES Cyber Systems as</p>	<p>BES Cyber Systems, but did not address three of the six topics required by R1. (R1.2)</p> <p>OR</p> <p>The Responsible Entity did not complete its review of the one or more documented cyber security policies for its assets identified in CIP-002 containing low impact BES Cyber Systems as required by R1 within 17 calendar months but did complete this review in less than or equal to 18 calendar months of the previous review. (R1.2)</p> <p>OR</p> <p>The Responsible Entity did not complete its approval of the one or more documented cyber security policies for its</p>	<p>OR</p> <p>The Responsible Entity documented one or more cyber security policies for its assets identified in CIP-002 containing low impact BES Cyber Systems, but did not address four or more of the six topics required by R1. (R1.2)</p> <p>OR</p> <p>The Responsible Entity did not have any documented cyber security policies for its assets identified in CIP-002 containing low impact BES Cyber Systems as required by R1. (R1.2)</p> <p>OR</p>

R #	Time Horizon	VRF	Violation Severity Levels (CIP-003-87)			
			Lower VSL	Moderate VSL	High VSL	Severe VSL
			<p>required by Requirement R1 within 15 calendar months but did not complete this review in less than or equal to 16 calendar months of the previous review. (R1.2)</p> <p>OR</p> <p>The Responsible Entity did not complete its approval of the one or more documented cyber security policies for its assets identified in CIP-002 containing low impact BES Cyber Systems as required by Requirement R1 by the CIP Senior Manager within 15 calendar months but did not complete this</p>	<p>required by Requirement R1 within 16 calendar months but did not complete this review in less than or equal to 17 calendar months of the previous review. (R1.2)</p> <p>OR</p> <p>The Responsible Entity did not complete its approval of the one or more documented cyber security policies for its assets identified in CIP-002 containing low impact BES Cyber Systems as required by Requirement R1 by the CIP Senior Manager within 16 calendar months but</p>	<p>assets identified in CIP-002 containing low impact BES Cyber Systems as required by Requirement R1 by the CIP Senior Manager within 17 calendar months but did not complete this approval in less than or equal to 18 calendar months of the previous approval. (R1.2)</p>	<p>The Responsible Entity did not complete its approval of the one or more documented cyber security policies for its assets identified in CIP-002 containing low impact BES Cyber Systems as required by Requirement R1 by the CIP Senior Manager within 18 calendar months of the previous approval. (R1.2)</p>

R #	Time Horizon	VRF	Violation Severity Levels (CIP-003- <del>87</del> )			
			Lower VSL	Moderate VSL	High VSL	Severe VSL
			approval in less than or equal to 16 calendar months of the previous approval. (R1.2)	did complete this approval in less than or equal to 17 calendar months of the previous approval. (R1.2)		
R2	Operations Planning	Lower	<p>The Responsible Entity documented its cyber security plan(s) for its assets containing low impact BES Cyber Systems, but failed to document cyber security awareness according to Requirement R2, Attachment 1, Section 1. (R2)</p> <p>OR</p> <p>The Responsible Entity implemented electronic access controls but failed to document its cyber security plan(s) for</p>	<p>The Responsible Entity documented its cyber security plan(s) for its assets containing low impact BES Cyber Systems, but failed to reinforce cyber security practices at least once every 15 calendar months according to Requirement R2, Attachment 1, Section 1. (R2)</p> <p>OR</p> <p>The Responsible Entity documented its cyber security plan(s) for its assets</p>	<p>The Responsible Entity documented the physical access controls for its assets containing low impact BES Cyber Systems, but failed to implement the physical security controls according to Requirement R2, Attachment 1, Section 2. (R2)</p> <p>OR</p> <p>The Responsible Entity documented its cyber security plan(s) for electronic access controls for its assets containing low impact BES Cyber Systems, but</p>	<p>The Responsible Entity failed to document and implement one or more cyber security plan(s) for its assets containing low impact BES Cyber Systems according to Requirement R2, Attachment 1. (R2)</p>

R #	Time Horizon	VRF	Violation Severity Levels (CIP-003- <del>87</del> )			
			Lower VSL	Moderate VSL	High VSL	Severe VSL
			<p>electronic access controls according to Requirement R2, Attachment 1, Section 3. (R2)</p> <p>OR</p> <p>The Responsible Entity documented its cyber security plan(s) for its assets containing low impact BES Cyber Systems, but failed to document one or more Cyber Security Incident response plan(s) according to Requirement R2, Attachment 1, Section 4. (R2)</p> <p>OR</p> <p>The Responsible Entity documented one or more Cyber Security Incident response plan(s)</p>	<p>containing low impact BES Cyber Systems, but failed to document physical security controls according to Requirement R2, Attachment 1, Section 2. (R2)</p> <p>OR</p> <p>The Responsible Entity documented its cyber security plan(s) for its assets containing low impact BES Cyber Systems, but failed to document electronic access controls according to Requirement R2, Attachment 1, Section 3. (R2)</p> <p>OR</p> <p>The Responsible Entity documented</p>	<p>failed to permit only necessary inbound and outbound electronic access controls according to Requirement R2, Attachment 1, Section 3.1. (R2)</p> <p>OR</p> <p>The Responsible Entity documented one or more Cyber Security Incident response plan(s) within its cyber security plan(s) for its assets containing low impact BES Cyber Systems, but failed to test each Cyber Security Incident response plan(s) at least once every 36 calendar months according to Requirement R2, Attachment 1, Section 4. (R2)</p> <p>OR</p>	

R #	Time Horizon	VRF	Violation Severity Levels (CIP-003- <del>87</del> )			
			Lower VSL	Moderate VSL	High VSL	Severe VSL
			<p>within its cyber security plan(s) for its assets containing low impact BES Cyber Systems, but failed to update each Cyber Security Incident response plan(s) within 180 days according to Requirement R2, Attachment 1, Section 4. (R2)</p> <p>OR</p> <p>The Responsible Entity documented its plan(s) for Transient Cyber Assets and Removable Media, but failed to manage its Transient Cyber Asset(s) according to Requirement R2, Attachment 1, Section 5.1. (R2)</p>	<p>its cyber security plan(s) for electronic access controls but failed to implement authentication for all Dial-up Connectivity that provides access to low impact BES Cyber System(s), per Cyber Asset capability according to Requirement R2, Attachment 1, Section 3.2 (R2)</p> <p>OR</p> <p>The Responsible Entity documented one or more incident response plan(s) within its cyber security plan(s) for its assets containing low impact BES Cyber Systems, but failed to include the process for identification,</p>	<p>The Responsible Entity documented the determination of whether an identified Cyber Security Incident is a Reportable Cyber Security Incident, but failed to notify the Electricity Information Sharing and Analysis Center (E-ISAC) according to Requirement R2, Attachment 1, Section 4. (R2)</p> <p>OR</p> <p>The Responsible Entity documented its plan(s) for Transient Cyber Assets and Removable Media, but failed to implement mitigation for the introduction of malicious code for Transient Cyber Assets managed by the Responsible Entity</p>	



R #	Time Horizon	VRF	Violation Severity Levels (CIP-003-87)			
			Lower VSL	Moderate VSL	High VSL	Severe VSL
			<p>OR</p> <p>The Responsible Entity documented its plan(s) for Transient Cyber Assets, but failed to document the Removable Media section(s) according to Requirement R2, Attachment 1, Section 5.3. (R2)</p>	<p>classification, and response to Cyber Security Incidents according to Requirement R2, Attachment 1, Section 4. (R2)</p> <p>OR</p> <p>The Responsible Entity documented its cyber security plan(s) for its assets containing low impact BES Cyber Systems, but failed to document the determination of whether an identified Cyber Security Incident is a Reportable Cyber Security Incident and subsequent notification to the Electricity Information Sharing and Analysis Center</p>	<p>according to Requirement R2, Attachment 1, Section 5.1. (R2)</p> <p>OR</p> <p>The Responsible Entity documented its plan(s) for Transient Cyber Assets and Removable Media, but failed to implement mitigation for the introduction of malicious code for Transient Cyber Assets managed by a party other than the Responsible Entity according to Requirement R2, Attachment 1, Section 5.2. (R2)</p> <p>OR</p> <p>The Responsible Entity documented its plan(s) for Transient Cyber Assets and Removable</p>	

R #	Time Horizon	VRF	Violation Severity Levels (CIP-003-87)			
			Lower VSL	Moderate VSL	High VSL	Severe VSL
				<p>(E-ISAC) according to Requirement R2, Attachment 1, Section 4. (R2)</p> <p>OR</p> <p>The Responsible Entity documented its plan(s) for Transient Cyber Assets and Removable Media, but failed to document mitigation for the introduction of malicious code for Transient Cyber Assets managed by the Responsible Entity according to Requirement R2, Attachment 1, Sections 5.1 and 5.3. (R2)</p> <p>OR</p> <p>The Responsible Entity documented</p>	<p>Media, but failed to implement mitigation for the threat of detected malicious code on the Removable Media prior to connecting Removable Media to a low impact BES Cyber System according to Requirement R2, Attachment 1, Section 5.3. (R2)</p>	

R #	Time Horizon	VRF	Violation Severity Levels (CIP-003- <del>87</del> )			
			Lower VSL	Moderate VSL	High VSL	Severe VSL
				its plan(s) for Transient Cyber Assets and Removable Media, but failed to document mitigation for the introduction of malicious code for Transient Cyber Assets managed by a party other than the Responsible Entity according to Requirement R2, Attachment 1, Section 5.2. (R2)  OR  The Responsible Entity documented its plan(s) for Transient Cyber Assets and Removable Media, but failed to implement the Removable Media section(s) according		

R #	Time Horizon	VRF	Violation Severity Levels (CIP-003- <del>87</del> )			
			Lower VSL	Moderate VSL	High VSL	Severe VSL
				to Requirement R2, Attachment 1, Section 5.3. (R2)		
<b>R3</b>	<b>Operations Planning</b>	<b>Medium</b>	The Responsible Entity has identified by name a CIP Senior Manager, but did not document changes to the CIP Senior Manager within 30 calendar days but did document this change in less than 40 calendar days of the change. (R3)	The Responsible Entity has identified by name a CIP Senior Manager, but did not document changes to the CIP Senior Manager within 40 calendar days but did document this change in less than 50 calendar days of the change. (R3)	The Responsible Entity has identified by name a CIP Senior Manager, but did not document changes to the CIP Senior Manager within 50 calendar days but did document this change in less than 60 calendar days of the change. (R3)	The Responsible Entity has not identified, by name, a CIP Senior Manager.  OR The Responsible Entity has identified by name a CIP Senior Manager, but did not document changes to the CIP Senior Manager within 60 calendar days of the change. (R3)
<b>R4</b>	<b>Operations Planning</b>	<b>Lower</b>	The Responsible Entity has identified a delegate by name, title, date of delegation, and specific actions	The Responsible Entity has identified a delegate by name, title, date of delegation, and specific actions	The Responsible Entity has identified a delegate by name, title, date of delegation, and specific actions delegated, but did not document	The Responsible Entity has used delegated authority for actions where allowed by the CIP Standards, but does

R #	Time Horizon	VRF	Violation Severity Levels (CIP-003-87)			
			Lower VSL	Moderate VSL	High VSL	Severe VSL
			delegated, but did not document changes to the delegate within 30 calendar days but did document this change in less than 40 calendar days of the change. (R4)	delegated, but did not document changes to the delegate within 40 calendar days but did document this change in less than 50 calendar days of the change. (R4)	changes to the delegate within 50 calendar days but did document this change in less than 60 calendar days of the change. (R4)	not have a process to delegate actions from the CIP Senior Manager. (R4)  OR  The Responsible Entity has identified a delegate by name, title, date of delegation, and specific actions delegated, but did not document changes to the delegate within 60 calendar days of the change. (R4)

**D. Regional Variances**

None.

**E. Interpretations**

None.

**F. Associated Documents**

None.

### Version History

Version	Date	Action	Change Tracking
1	1/16/06	R3.2 — Change “Control Center” to “control center.”	3/24/06
2	9/30/09	Modifications to clarify the requirements and to bring the compliance elements into conformance with the latest guidelines for developing compliance elements of standards.  Removal of reasonable business judgment.  Replaced the RRO with the RE as a responsible entity.  Rewording of Effective Date.  Changed compliance monitor to Compliance Enforcement Authority.	
3	12/16/09	Updated Version Number from -2 to -3  In Requirement 1.6, deleted the sentence pertaining to removing component or system from service in order to perform testing, in response to FERC order issued September 30, 2009.	
3	12/16/09	Approved by the NERC Board of Trustees.	
3	3/31/10	Approved by FERC.	
4	1/24/11	Approved by the NERC Board of Trustees.	
5	11/26/12	Adopted by the NERC Board of Trustees.	Modified to coordinate with other CIP standards and to revise format to use RBS Template.
5	11/22/13	FERC Order issued approving CIP-003-5.	

Version	Date	Action	Change Tracking
6	11/13/14	Adopted by the NERC Board of Trustees.	Addressed two FERC directives from Order No. 791 related to identify, assess, and correct language and communication networks.
6	2/12/15	Adopted by the NERC Board of Trustees.	Replaces the version adopted by the Board on 11/13/2014. Revised version addresses remaining directives from Order No. 791 related to transient devices and low impact BES Cyber Systems.
6	1/21/16	FERC Order issued approving CIP-003-6. Docket No. RM15-14-000	
7	2/9/17	Adopted by the NERC Board of Trustees.	Revised to address FERC Order No. 822 directives regarding (1) the definition of LERC and (2) transient devices.
7	4/19/18	FERC Order issued approving CIP-003-7. Docket No. RM17-11-000	

CIP-003-~~87~~ - Cyber Security — Security Management Controls

---

Version	Date	Action	Change Tracking
<u>8</u>	<u>TBD</u>	<u>FERC Order issued approving CIP-003-7.</u> <u>Docket No. RM17-11-000</u>	



## Attachment 1

### Required Sections for Cyber Security Plan(s) for Assets Containing Low Impact BES Cyber Systems

Responsible Entities shall include each of the sections provided below in the cyber security plan(s) required under Requirement R2.

Responsible Entities with multiple-impact BES Cyber Systems ratings can utilize policies, procedures, and processes for their high or medium impact BES Cyber Systems to fulfill the sections for the development of low impact cyber security plan(s). Each Responsible Entity can develop a cyber security plan(s) either by individual asset or groups of assets.

**Section 1. Cyber Security Awareness:** Each Responsible Entity shall reinforce, at least once every 15 calendar months, cyber security practices (which may include associated physical security practices).

**Section 2. Physical Security Controls:** Each Responsible Entity shall control physical access, based on need as determined by the Responsible Entity, to (1) the asset or the locations of the low impact BES Cyber Systems within the asset, and (2) the Cyber Asset(s), as specified by the Responsible Entity, that provide electronic access control(s) implemented for Section 3.1, if any.

**Section 3. Electronic Access Controls:** For each asset containing low impact BES Cyber System(s) identified pursuant to CIP-002, the Responsible Entity shall implement electronic access controls to:

- 3.1** Permit only necessary inbound and outbound electronic access as determined by the Responsible Entity for any communications that are:
  - i. between a low impact BES Cyber System(s) and a Cyber Asset(s) outside the asset containing low impact BES Cyber System(s);
  - ii. using a routable protocol when entering or leaving the asset containing the low impact BES Cyber System(s); and
  - iii. not used for time-sensitive protection or control functions between intelligent electronic devices (e.g., communications using protocol IEC TR-61850-90-5 R-GOOSE).
- 3.2** Authenticate all Dial-up Connectivity, if any, that provides access to low impact BES Cyber System(s), per Cyber Asset capability.

**Section 4. Cyber Security Incident Response:** Each Responsible Entity shall have one or more Cyber Security Incident response plan(s), either by asset or group of assets, which shall include:

- 4.1** Identification, classification, and response to Cyber Security Incidents;
- 4.2** Determination of whether an identified Cyber Security Incident is a Reportable Cyber Security Incident and subsequent notification to the

Electricity Information Sharing and Analysis Center (E-ISAC), unless prohibited by law;

- 4.3 Identification of the roles and responsibilities for Cyber Security Incident response by groups or individuals;
- 4.4 Incident handling for Cyber Security Incidents;
- 4.5 Testing the Cyber Security Incident response plan(s) at least once every 36 calendar months by: (1) responding to an actual Reportable Cyber Security Incident; (2) using a drill or tabletop exercise of a Reportable Cyber Security Incident; or (3) using an operational exercise of a Reportable Cyber Security Incident; and
- 4.6 Updating the Cyber Security Incident response plan(s), if needed, within 180 calendar days after completion of a Cyber Security Incident response plan(s) test or actual Reportable Cyber Security Incident.

**Section 5. Transient Cyber Asset and Removable Media Malicious Code Risk Mitigation:** Each Responsible Entity shall implement, except under CIP Exceptional Circumstances, one or more plan(s) to achieve the objective of mitigating the risk of the introduction of malicious code to low impact BES Cyber Systems through the use of Transient Cyber Assets or Removable Media. The plan(s) shall include:

- 5.1 For Transient Cyber Asset(s) managed by the Responsible Entity, if any, the use of one or a combination of the following in an ongoing or on-demand manner (per Transient Cyber Asset capability):
  - Antivirus software, including manual or managed updates of signatures or patterns;
  - Application whitelisting; or
  - Other method(s) to mitigate the introduction of malicious code.

**5.2** For Transient Cyber Asset(s) managed by a party other than the Responsible Entity, if any:

**5.25.2.1** ~~Use, the use of~~ one or a combination of the following prior to connecting the Transient Cyber Asset to a low impact BES Cyber System (per Transient Cyber Asset capability):

- Review of antivirus update level;
- Review of antivirus update process used by the party;
- Review of application whitelisting used by the party;
- Review use of live operating system and software executable only from read-only media;
- Review of system hardening used by the party; or

Formatted: Indent: Left: 1.25"

Formatted: Bulleted + Level: 4 + Aligned at: 2" + Indent at: 2.25"

- Other method(s) to mitigate the introduction of malicious code.

5.2.2 For any method used pursuant to 5.2.1, Responsible Entities shall determine whether any additional mitigation actions are necessary and implement such actions prior to connecting the Transient Cyber Asset.

**5.3** For Removable Media, the use of each of the following:

- 5.3.1** Method(s) to detect malicious code on Removable Media using a Cyber Asset other than a BES Cyber System; and
- 5.3.2** Mitigation of the threat of detected malicious code on the Removable Media prior to connecting Removable Media to a low impact BES Cyber System.

## Attachment 2

### Examples of Evidence for Cyber Security Plan(s) for Assets Containing Low Impact BES Cyber Systems

**Section 1.** Cyber Security Awareness: An example of evidence for Section 1 may include, but is not limited to, documentation that the reinforcement of cyber security practices occurred at least once every 15 calendar months. The evidence could be documentation through one or more of the following methods:

- Direct communications (for example, e-mails, memos, or computer-based training);
- Indirect communications (for example, posters, intranet, or brochures); or
- Management support and reinforcement (for example, presentations or meetings).

**Section 2.** Physical Security Controls: Examples of evidence for Section 2 may include, but are not limited to:

- Documentation of the selected access control(s) (e.g., card key, locks, perimeter controls), monitoring controls (e.g., alarm systems, human observation), or other operational, procedural, or technical physical security controls that control physical access to both:
  - a. The asset, if any, or the locations of the low impact BES Cyber Systems within the asset; and
  - b. The Cyber Asset(s) specified by the Responsible Entity that provide(s) electronic access controls implemented for Attachment 1, Section 3.1, if any.

**Section 3.** Electronic Access Controls: Examples of evidence for Section 3 may include, but are not limited to:

1. Documentation showing that at each asset or group of assets containing low impact BES Cyber Systems, routable communication between a low impact BES Cyber System(s) and a Cyber Asset(s) outside the asset is restricted by electronic access controls to permit only inbound and outbound electronic access that the Responsible Entity deems necessary, except where an entity provides rationale that communication is used for time-sensitive protection or control functions between intelligent electronic devices. Examples of such documentation may include, but are not limited to representative diagrams that illustrate control of inbound and outbound communication(s) between the low impact BES Cyber System(s) and a Cyber Asset(s) outside the asset containing low impact BES Cyber System(s) or lists of implemented electronic access controls (e.g., access control lists restricting IP addresses, ports, or services; implementing unidirectional gateways).

2. Documentation of authentication for Dial-up Connectivity (e.g., dial out only to a preprogrammed number to deliver data, dial-back modems, modems that must be remotely controlled by the control center or control room, or access control on the BES Cyber System).

**Section 4.** Cyber Security Incident Response: An example of evidence for Section 4 may include, but is not limited to, dated documentation, such as policies, procedures, or process documents of one or more Cyber Security Incident response plan(s) developed either by asset or group of assets that include the following processes:

1. to identify, classify, and respond to Cyber Security Incidents; to determine whether an identified Cyber Security Incident is a Reportable Cyber Security Incident and for notifying the Electricity Information Sharing and Analysis Center (E-ISAC);
2. to identify and document the roles and responsibilities for Cyber Security Incident response by groups or individuals (e.g., initiating, documenting, monitoring, reporting, etc.);
3. for incident handling of a Cyber Security Incident (e.g., containment, eradication, or recovery/incident resolution);
4. for testing the plan(s) along with the dated documentation that a test has been completed at least once every 36 calendar months; and
5. to update, as needed, Cyber Security Incident response plan(s) within 180 calendar days after completion of a test or actual Reportable Cyber Security Incident.

**Section 5.** Transient Cyber Asset and Removable Media Malicious Code Risk Mitigation:

1. Examples of evidence for Section 5.1 may include, but are not limited to, documentation of the method(s) used to mitigate the introduction of malicious code such as antivirus software and processes for managing signature or pattern updates, application whitelisting practices, processes to restrict communication, or other method(s) to mitigate the introduction of malicious code. If a Transient Cyber Asset does not have the capability to use method(s) that mitigate the introduction of malicious code, evidence may include documentation by the vendor or Responsible Entity that identifies that the Transient Cyber Asset does not have the capability.
2. Examples of evidence for Section 5.2.1 may include, but are not limited to, documentation from change management systems, electronic mail or procedures that document a review of the installed antivirus update level; memoranda, electronic mail, system documentation, policies or contracts from the party other than the Responsible Entity that identify the antivirus update process, the use of application whitelisting, use of live operating systems or system hardening performed by the party other than the Responsible Entity; evidence from change management systems, electronic mail or contracts that

identifies the Responsible Entity's acceptance that the practices of the party other than the Responsible Entity are acceptable; or documentation of other method(s) to mitigate malicious code for Transient Cyber Asset(s) managed by a party other than the Responsible Entity. If a Transient Cyber Asset does not have the capability to use method(s) that mitigate the introduction of malicious code, evidence may include documentation by the Responsible Entity or the party other than the Responsible Entity that identifies that the Transient Cyber Asset does not have the capability.

Examples of evidence for Attachment 1, Section 5.2.2 may include, but are not limited to, documentation from change management systems, electronic mail, or contracts that identifies a review to determine whether additional mitigation is necessary and has been implemented prior to connecting the Transient Cyber Asset managed by a party other than the Responsible Entity.

3. Examples of evidence for Section 5.3.1 may include, but are not limited to, documented process(es) of the method(s) used to detect malicious code such as results of scan settings for Removable Media, or implementation of on-demand scanning. Examples of evidence for Section 5.3.2 may include, but are not limited to, documented process(es) for the method(s) used for mitigating the threat of detected malicious code on Removable Media, such as logs from the method(s) used to detect malicious code that show the results of scanning and the mitigation of detected malicious code on Removable Media or documented confirmation by the entity that the Removable Media was deemed to be free of malicious code.

## Guidelines and Technical Basis

### Section 4 – Scope of Applicability of the CIP Cyber Security Standards

Section “4. Applicability” of the standards provides important information for Responsible Entities to determine the scope of the applicability of the CIP Cyber Security Requirements.

Section “4.1. Functional Entities” is a list of NERC functional entities to which the standard applies. If the entity is registered as one or more of the functional entities listed in Section 4.1, then the NERC CIP Cyber Security Standards apply. Note that there is a qualification in Section 4.1 that restricts the applicability in the case of Distribution Providers to only those that own certain types of systems and equipment listed in 4.2.

Section “4.2. Facilities” defines the scope of the Facilities, systems, and equipment owned by the Responsible Entity, as qualified in Section 4.1, that is subject to the requirements of the standard. In addition to the set of BES Facilities, Control Centers, and other systems and equipment, the list includes the set of systems and equipment owned by Distribution Providers. While the NERC Glossary term “Facilities” already includes the BES characteristic, the additional use of the term BES here is meant to reinforce the scope of applicability of these Facilities where it is used, especially in this applicability scoping section. This in effect sets the scope of Facilities, systems, and equipment that is subject to the standards.

#### Requirement R1:

In developing policies in compliance with Requirement R1, the number of policies and their content should be guided by a Responsible Entity's management structure and operating conditions. Policies might be included as part of a general information security program for the entire organization, or as components of specific programs. The Responsible Entity has the flexibility to develop a single comprehensive cyber security policy covering the required topics, or it may choose to develop a single high-level umbrella policy and provide additional policy detail in lower level documents in its documentation hierarchy. In the case of a high-level umbrella policy, the Responsible Entity would be expected to provide the high-level policy as well as the additional documentation in order to demonstrate compliance with CIP-003-87, Requirement R1.

If a Responsible Entity has any high or medium impact BES Cyber Systems, the one or more cyber security policies must cover the nine subject matter areas required by CIP-003-87, Requirement R1, Part 1.1. If a Responsible Entity has identified from CIP-002 any assets containing low impact BES Cyber Systems, the one or more cyber security policies must cover the six subject matter areas required by Requirement R1, Part 1.2.

Responsible Entities that have multiple-impact rated BES Cyber Systems are not required to create separate cyber security policies for high, medium, or low impact BES Cyber Systems. The Responsible Entities have the flexibility to develop policies that cover all three impact ratings.

Implementation of the cyber security policy is not specifically included in CIP-003-87, Requirement R1 as it is envisioned that the implementation of this policy is evidenced through successful implementation of CIP-003 through CIP-011. However, Responsible Entities are encouraged not to limit the scope of their cyber security policies to only those requirements in NERC cyber security Reliability Standards, but to develop a holistic cyber security policy

## CIP-003-87 Supplemental Material

---

appropriate for its organization. Elements of a policy that extend beyond the scope of NERC's cyber security Reliability Standards will not be considered candidates for potential violations although they will help demonstrate the organization's internal culture of compliance and posture towards cyber security.

For Part 1.1, the Responsible Entity may consider the following for each of the required topics in its one or more cyber security policies for medium and high impact BES Cyber Systems, if any:

### 1.1.1 Personnel and training (CIP-004)

- Organization position on acceptable background investigations
- Identification of possible disciplinary action for violating this policy
- Account management

### 1.1.2 Electronic Security Perimeters (CIP-005) including Interactive Remote Access

- Organization stance on use of wireless networks
- Identification of acceptable authentication methods
- Identification of trusted and untrusted resources
- Monitoring and logging of ingress and egress at Electronic Access Points
- Maintaining up-to-date anti-malware software before initiating Interactive Remote Access
- Maintaining up-to-date patch levels for operating systems and applications used to initiate Interactive Remote Access
- Disabling VPN "split-tunneling" or "dual-homed" workstations before initiating Interactive Remote Access
- For vendors, contractors, or consultants: include language in contracts that requires adherence to the Responsible Entity's Interactive Remote Access controls

### 1.1.3 Physical security of BES Cyber Systems (CIP-006)

- Strategy for protecting Cyber Assets from unauthorized physical access
- Acceptable physical access control methods
- Monitoring and logging of physical ingress

### 1.1.4 System security management (CIP-007)

- Strategies for system hardening
- Acceptable methods of authentication and access control
- Password policies including length, complexity, enforcement, prevention of brute force attempts
- Monitoring and logging of BES Cyber Systems



## CIP-003-87 Supplemental Material

---

- 1.1.5 Incident reporting and response planning (CIP-008)
  - Recognition of Cyber Security Incidents
  - Appropriate notifications upon discovery of an incident
  - Obligations to report Cyber Security Incidents
- 1.1.6 Recovery plans for BES Cyber Systems (CIP-009)
  - Availability of spare components
  - Availability of system backups
- 1.1.7 Configuration change management and vulnerability assessments (CIP-010)
  - Initiation of change requests
  - Approval of changes
  - Break-fix processes
- 1.1.8 Information protection (CIP-011)
  - Information access control methods
  - Notification of unauthorized information disclosure
  - Information access on a need-to-know basis
- 1.1.9 Declaring and responding to CIP Exceptional Circumstances
  - Processes to invoke special procedures in the event of a CIP Exceptional Circumstance
  - Processes to allow for exceptions to policy that do not violate CIP requirements

For Part 1.2, the Responsible Entity may consider the following for each of the required topics in its one or more cyber security policies for assets containing low impact BES Cyber Systems, if any:

- 1.2.1 Cyber security awareness
  - Method(s) for delivery of security awareness
  - Identification of groups to receive cyber security awareness
- 1.2.2 Physical security controls
  - Acceptable approach(es) for selection of physical security control(s)
- 1.2.3 Electronic access controls
  - Acceptable approach(es) for selection of electronic access control(s)
- 1.2.4 Cyber Security Incident response
  - Recognition of Cyber Security Incidents

## CIP-003-87 Supplemental Material

---

- Appropriate notifications upon discovery of an incident
- Obligations to report Cyber Security Incidents

### 1.2.5 Transient Cyber Assets and Removable Media Malicious Code Risk Mitigation

- Acceptable use of Transient Cyber Asset(s) and Removable Media
- Method(s) to mitigate the risk of the introduction of malicious code to low impact BES Cyber Systems from Transient Cyber Assets and Removable Media
- Method(s) to request Transient Cyber Asset and Removable Media

### 1.2.6 Declaring and responding to CIP Exceptional Circumstances

- Process(es) to declare a CIP Exceptional Circumstance
- Process(es) to respond to a declared CIP Exceptional Circumstance

Requirements relating to exceptions to a Responsible Entity's security policies were removed because it is a general management issue that is not within the scope of a reliability requirement. It is an internal policy requirement and not a reliability requirement. However, Responsible Entities are encouraged to continue this practice as a component of their cyber security policies.

In this and all subsequent required approvals in the NERC CIP Reliability Standards, the Responsible Entity may elect to use hardcopy or electronic approvals to the extent that there is sufficient evidence to ensure the authenticity of the approving party.

#### **Requirement R2:**

The intent of Requirement R2 is for each Responsible Entity to create, document, and implement one or more cyber security plan(s) that address the security objective for the protection of low impact BES Cyber Systems. The required protections are designed to be part of a program that covers the low impact BES Cyber Systems collectively at an asset level (based on the list of assets containing low impact BES Cyber Systems identified in CIP-002), but not at an individual device or system level.

**Requirement R2, Attachment 1**

As noted, Attachment 1 contains the sections that must be included in the cyber security plan(s). The intent is to allow entities that have a combination of high, medium, and low impact BES Cyber Systems the flexibility to choose, if desired, to cover their low impact BES Cyber Systems (or any subset) under their programs used for the high or medium impact BES Cyber Systems rather than maintain two separate programs. The purpose of the cyber security plan(s) in Requirement R2 is for Responsible Entities to use the cyber security plan(s) as a means of documenting their approaches to meeting the subject matter areas. The cyber security plan(s) can be used to reference other policies and procedures that demonstrate “how” the Responsible Entity is meeting each of the subject matter areas, or Responsible Entities can develop comprehensive cyber security plan(s) that contain all of the detailed implementation content solely within the cyber security plan itself. To meet the obligation for the cyber security plan, the expectation is that the cyber security plan contains or references sufficient details to address the implementation of each of the required subject matters areas.

Guidance for each of the subject matter areas of Attachment 1 is provided below.

**Requirement R2, Attachment 1, Section 1 – Cyber Security Awareness**

The intent of the cyber security awareness program is for entities to reinforce good cyber security practices with their personnel at least once every 15 calendar months. The entity has the discretion to determine the topics to be addressed and the manner in which it will communicate these topics. As evidence of compliance, the Responsible Entity should be able to produce the awareness material that was delivered according to the delivery method(s) (e.g., posters, emails, or topics at staff meetings, etc.). The standard drafting team does not intend for Responsible Entities to be required to maintain lists of recipients and track the reception of the awareness material by personnel.

Although the focus of the awareness is cyber security, it does not mean that only technology-related topics can be included in the program. Appropriate physical security topics (e.g., tailgating awareness and protection of badges for physical security, or “If you see something, say something” campaigns, etc.) are valid for cyber security awareness. The intent is to cover topics concerning any aspect of the protection of BES Cyber Systems.

**Requirement R2, Attachment 1, Section 2 – Physical Security Controls**

The Responsible Entity must document and implement methods to control physical access to (1) the asset or the locations of low impact BES Cyber Systems within the asset, and (2) Cyber Assets that implement the electronic access control(s) specified by the Responsible Entity in Attachment 1, Section 3.1, if any. If these Cyber Assets implementing the electronic access controls are located within the same asset as the low impact BES Cyber Asset(s) and inherit the same physical access controls and the same need as outlined in Section 2, this may be noted by the Responsible Entity in either its policies or cyber security plan(s) to avoid duplicate documentation of the same controls.

The Responsible Entity has the flexibility to select the methods used to meet the objective of controlling physical access to (1) the asset(s) containing low impact BES Cyber System(s) or the low impact BES Cyber Systems themselves and (2) the electronic access control Cyber Assets

specified by the Responsible Entity, if any. The Responsible Entity may use one or a combination of physical access controls, monitoring controls, or other operational, procedural, or technical physical security controls. Entities may use perimeter controls (e.g., fences with locked gates, guards, or site access policies, etc.) or more granular areas of physical access control in areas where low impact BES Cyber Systems are located, such as control rooms or control houses.

The security objective is to control the physical access based on need as determined by the Responsible Entity. The need for physical access can be documented at the policy level. The standard drafting team did not intend to obligate an entity to specify a need for each physical access or authorization of an individual for physical access.

Monitoring as a physical security control can be used as a complement or an alternative to physical access control. Examples of monitoring controls include, but are not limited to: (1) alarm systems to detect motion or entry into a controlled area, or (2) human observation of a controlled area. Monitoring does not necessarily require logging and maintaining logs but could include monitoring that physical access has occurred or been attempted (e.g., door alarm, or human observation, etc.). The standard drafting team's intent is that the monitoring does not need to be per low impact BES Cyber System but should be at the appropriate level to meet the security objective of controlling physical access.

User authorization programs and lists of authorized users for physical access are not required although they are an option to meet the security objective.

**Requirement R2, Attachment 1, Section 3 – Electronic Access Controls**

Section 3 requires the establishment of electronic access controls for assets containing low impact BES Cyber Systems when there is routable protocol communication or Dial-up Connectivity between Cyber Asset(s) outside of the asset containing the low impact BES Cyber System(s) and the low impact BES Cyber System(s) within such asset. The establishment of electronic access controls is intended to reduce the risks associated with uncontrolled communication using routable protocols or Dial-up Connectivity.

When implementing Attachment 1, Section 3.1, Responsible Entities should note that electronic access controls to permit only necessary inbound and outbound electronic access are required for communications when those communications meet all three of the criteria identified in Attachment 1, Section 3.1. The Responsible Entity should evaluate the communications and when all three criteria are met, the Responsible Entity must document and implement electronic access control(s).

When identifying electronic access controls, Responsible Entities are provided flexibility in the selection of the electronic access controls that meet their operational needs while meeting the security objective of allowing only necessary inbound and outbound electronic access to low impact BES Cyber Systems that use routable protocols between a low impact BES Cyber System(s) and Cyber Asset(s) outside the asset.

In essence, the intent is for Responsible Entities to determine whether there is communication between a low impact BES Cyber System(s) and a Cyber Asset(s) outside the asset containing

low impact BES Cyber System(s) that uses a routable protocol when entering or leaving the asset or Dial-up Connectivity to the low impact BES Cyber System(s). Where such communication is present, Responsible Entities should document and implement electronic access control(s). Where routable protocol communication for time-sensitive protection or control functions between intelligent electronic devices that meets the exclusion language is present, Responsible Entities should document that communication, but are not required to establish any specific electronic access controls.

The inputs to this requirement are the assets identified in CIP-002 as containing low impact BES Cyber System(s); therefore, the determination of routable protocol communications or Dial-up Connectivity is an attribute of the asset. However, it is not intended for communication that provides no access to or from the low impact BES Cyber System(s), but happens to be located at the asset with the low impact BES Cyber System(s), to be evaluated for electronic access controls.

#### Electronic Access Control Exclusion

In order to avoid future technology issues, the obligations for electronic access controls exclude communications between intelligent electronic devices that use routable communication protocols for time-sensitive protection or control functions, such as IEC TR-61850-90-5 R-GOOSE messaging. Time-sensitive in this context generally means functions that would be negatively impacted by the latency introduced in the communications by the required electronic access controls. This time-sensitivity exclusion does not apply to SCADA communications which typically operate on scan rates of 2 seconds or greater. While technically time-sensitive, SCADA communications over routable protocols can withstand the delay introduced by electronic access controls. Examples of excluded time-sensitive communications are those communications which may necessitate the tripping of a breaker within a few cycles. A Responsible Entity using this technology is not expected to implement the electronic access controls noted herein. This exception was included so as not to inhibit the functionality of the time-sensitive characteristics related to this technology and not to preclude the use of such time-sensitive reliability enhancing functions if they use a routable protocol in the future.

#### **Considerations for Determining Routable Protocol Communications**

To determine whether electronic access controls need to be implemented, the Responsible Entity has to determine whether there is communication between a low impact BES Cyber System(s) and a Cyber Asset(s) outside the asset containing the low impact BES Cyber System(s) that uses a routable protocol when entering or leaving the asset.

When determining whether a routable protocol is entering or leaving the asset containing the low impact BES Cyber System(s), Responsible Entities have flexibility in identifying an approach. One approach is for Responsible Entities to identify an “electronic boundary” associated with the asset containing low impact BES Cyber System(s). This is not an Electronic Security Perimeter *per se*, but a demarcation that demonstrates the routable protocol communication entering or leaving the asset between a low impact BES Cyber System and Cyber Asset(s) outside the asset to then have electronic access controls implemented. This electronic

boundary may vary by asset type (Control Center, substation, generation resource) and the specific configuration of the asset. If this approach is used, the intent is for the Responsible Entity to define the electronic boundary such that the low impact BES Cyber System(s) located at the asset are contained within the “electronic boundary.” This is strictly for determining which routable protocol communications and networks are internal or inside or local to the asset and which are external to or outside the asset.

Alternatively, the Responsible Entity may find the concepts of what is inside and outside to be intuitively obvious for a Cyber Asset(s) outside the asset containing low impact BES Cyber System(s) communicating to a low impact BES Cyber System(s) inside the asset. This may be the case when a low impact BES Cyber System(s) is communicating with a Cyber Asset many miles away and a clear and unambiguous demarcation exists. In this case, a Responsible Entity may decide not to identify an “electronic boundary,” but rather to simply leverage the unambiguous asset demarcation to ensure that the electronic access controls are placed between the low impact BES Cyber System(s) and the Cyber Asset(s) outside the asset.

#### **Determining Electronic Access Controls**

Once a Responsible Entity has determined that there is routable communication between a low impact BES Cyber System(s) and a Cyber Asset(s) outside the asset containing the low impact BES Cyber System(s) that uses a routable protocol when entering or leaving the asset containing the low impact BES Cyber System(s), the intent is for the Responsible Entity to document and implement its chosen electronic access control(s). The control(s) are intended to allow only “necessary” inbound and outbound electronic access as determined by the Responsible Entity. However the Responsible Entity chooses to document the inbound and outbound access permissions and the need, the intent is that the Responsible Entity is able to explain the reasons for the electronic access permitted. The reasoning for “necessary” inbound and outbound electronic access controls may be documented within the Responsible Entity’s cyber security plan(s), within a comment on an access control list, a database, spreadsheet or other policies or procedures associated with the electronic access controls.

#### **Concept Diagrams**

The diagrams on the following pages are provided as examples to illustrate various electronic access controls at a conceptual level. Regardless of the concepts or configurations chosen by the Responsible Entity, the intent is to achieve the security objective of permitting only necessary inbound and outbound electronic access for communication between low impact BES Cyber Systems and Cyber Asset(s) outside the asset containing the low impact BES Cyber System(s) using a routable protocol when entering or leaving the asset.

#### **NOTE:**

- This is not an exhaustive list of applicable concepts.
- The same legend is used in each diagram; however, the diagram may not contain all of the articles represented in the legend.

**Reference Model 1 – Host-based Inbound & Outbound Access Permissions**

The Responsible Entity may choose to utilize a host-based firewall technology on the low impact BES Cyber System(s) itself that manages the inbound and outbound electronic access permissions so that only necessary inbound and outbound electronic access is allowed between the low impact BES Cyber System(s) and the Cyber Asset(s) outside the asset containing the low impact BES Cyber System(s). When permitting the inbound and outbound electronic access permissions using access control lists, the Responsible Entity could restrict communication(s) using source and destination addresses or ranges of addresses. Responsible Entities could also restrict communication(s) using ports or services based on the capability of the electronic access control, the low impact BES Cyber System(s), or the application(s).

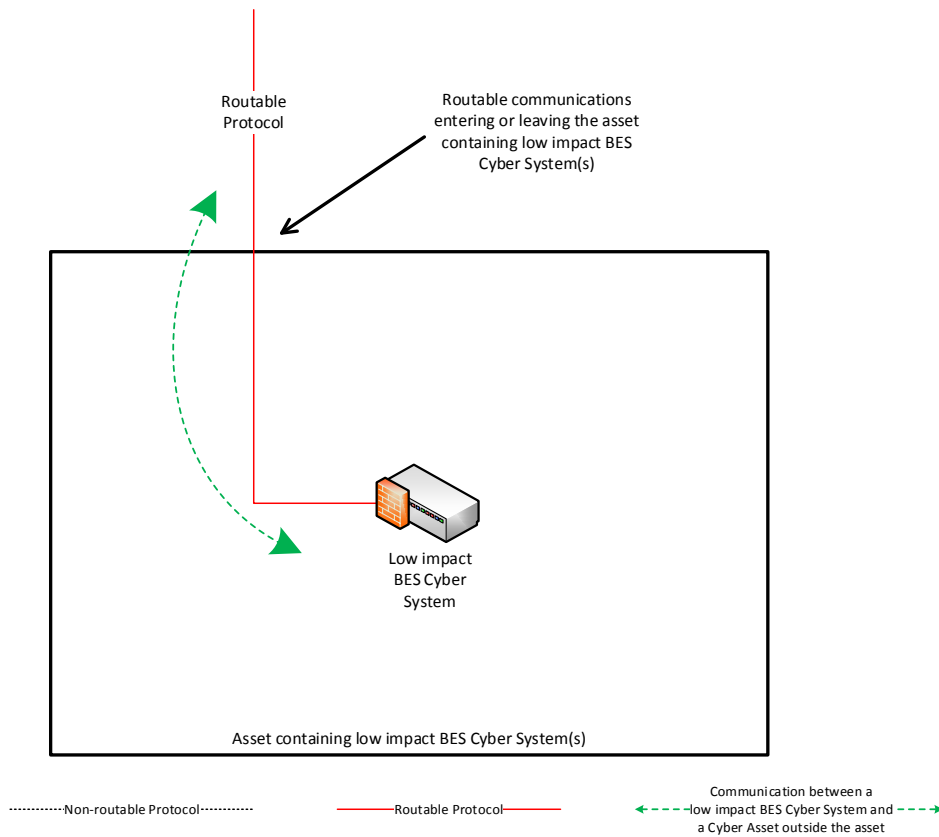

*Reference Model 1*

**Reference Model 2 – Network-based Inbound & Outbound Access Permissions**

The Responsible Entity may choose to use a security device that permits only necessary inbound and outbound electronic access to the low impact BES Cyber System(s) within the asset containing the low impact BES Cyber System(s). In this example, two low impact BES Cyber Systems are accessed using the routable protocol that is entering or leaving the asset containing the low impact BES Cyber System(s). The IP/Serial converter is continuing the same communications session from the Cyber Asset(s) that are outside the asset to the low impact BES Cyber System(s). The security device provides the electronic access controls to permit only necessary inbound and outbound routable protocol access to the low impact BES Cyber System(s). When permitting the inbound and outbound electronic access permissions using access control lists, the Responsible Entity could restrict communication(s) using source and destination addresses or ranges of addresses. Responsible Entities could also restrict communication(s) using ports or services based on the capability of the electronic access control, the low impact BES Cyber System(s), or the application(s).

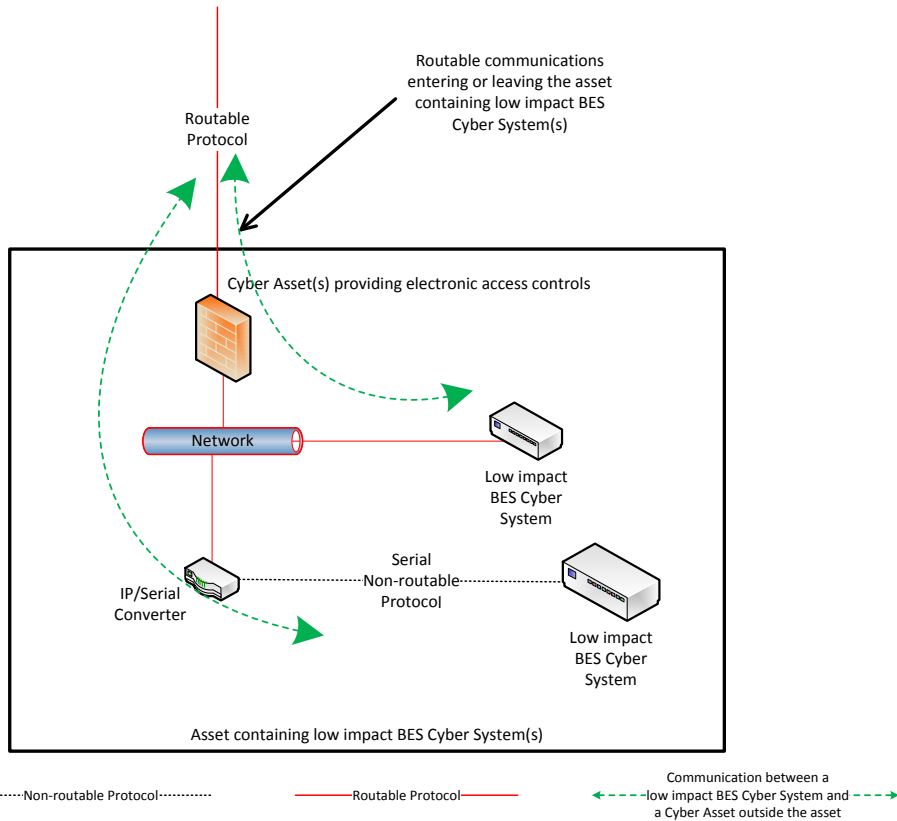

Reference Model 2



**Reference Model 3 – Centralized Network-based Inbound & Outbound Access Permissions**

The Responsible Entity may choose to utilize a security device at a centralized location that may or may not be at another asset containing low impact BES Cyber System(s). The electronic access control(s) do not necessarily have to reside inside the asset containing the low impact BES Cyber System(s). A security device is in place at “Location X” to act as the electronic access control and permit only necessary inbound and outbound routable protocol access between the low impact BES Cyber System(s) and the Cyber Asset(s) outside each asset containing low impact BES Cyber System(s). Care should be taken that electronic access to or between each asset is through the Cyber Asset(s) determined by the Responsible Entity to be performing electronic access controls at the centralized location. When permitting the inbound and outbound electronic access permissions using access control lists, the Responsible Entity could restrict communication(s) using source and destination addresses or ranges of addresses. Responsible Entities could also restrict communication(s) using ports or services based on the capability of the electronic access control, the low impact BES Cyber System(s), or the application(s).

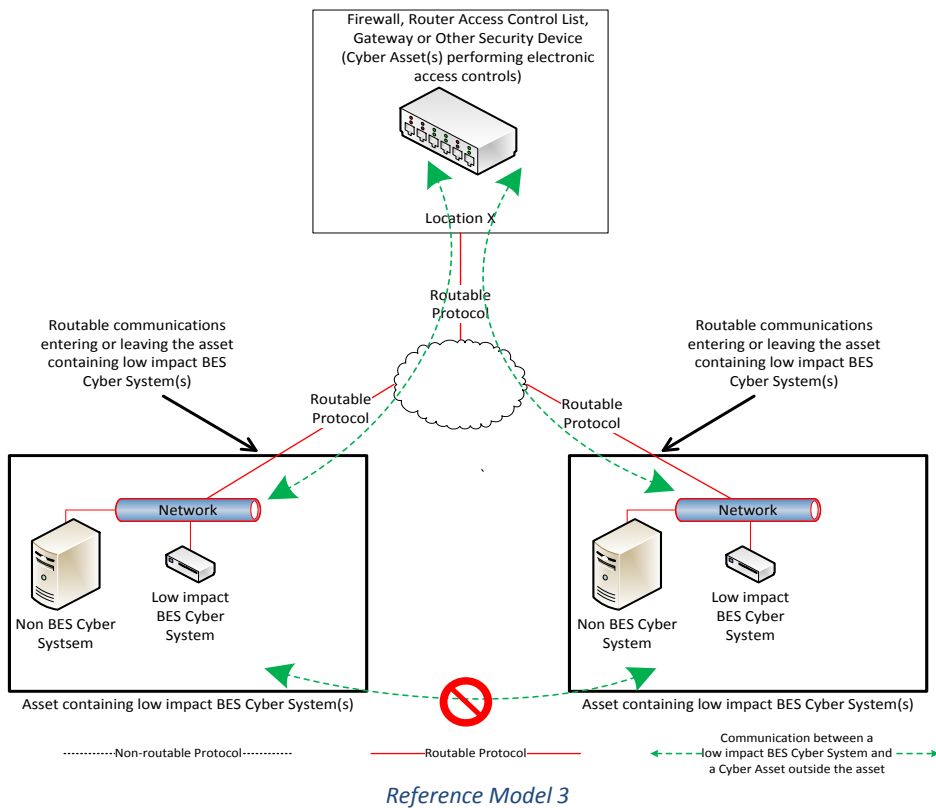

**Reference Model 4 – Uni-directional Gateway**

The Responsible Entity may choose to utilize a uni-directional gateway as the electronic access control. The low impact BES Cyber System(s) is not accessible (data cannot flow into the low impact BES Cyber System) using the routable protocol entering the asset due to the implementation of a “one-way” (uni-directional) path for data to flow. The uni-directional gateway is configured to permit only the necessary outbound communications using the routable protocol communication leaving the asset.

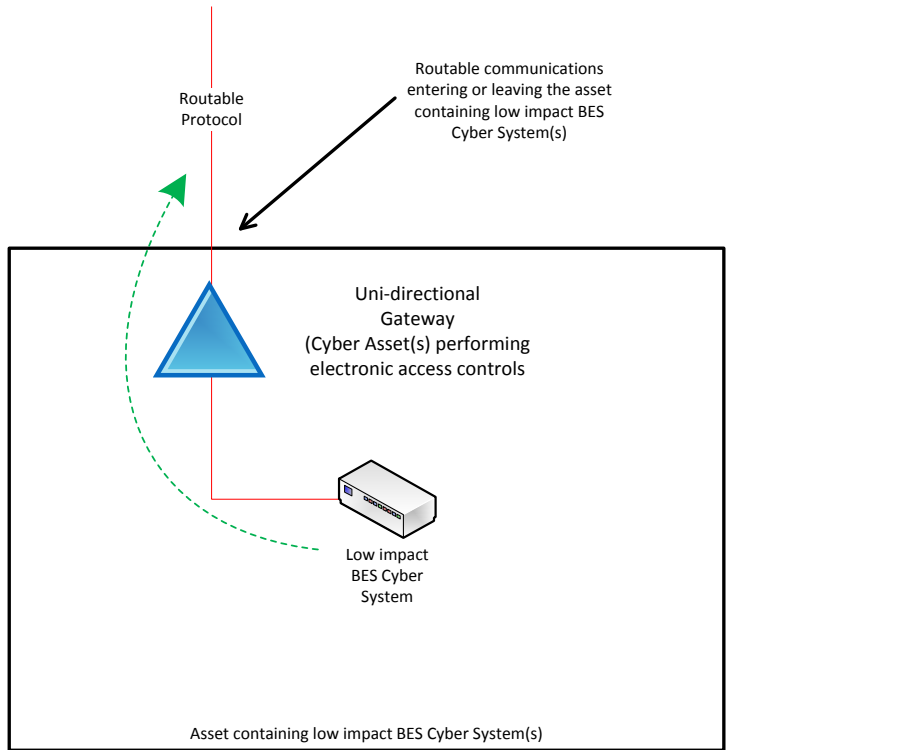

*Reference Model 4*

**Reference Model 5 – User Authentication**

This reference model demonstrates that Responsible Entities have flexibility in choosing electronic access controls so long as the security objective of the requirement is met. The Responsible Entity may choose to utilize a non-BES Cyber Asset located at the asset containing the low impact BES Cyber System that requires authentication for communication from the Cyber Asset(s) outside the asset. This non-BES Cyber System performing the authentication permits only authenticated communication to connect to the low impact BES Cyber System(s), meeting the first half of the security objective to permit only necessary inbound electronic access. Additionally, the non-BES Cyber System performing authentication is configured such that it permits only necessary outbound communication meeting the second half of the security objective. Often, the outbound communications would be controlled in this network architecture by permitting no communication to be initiated from the low impact BES Cyber System. This configuration may be beneficial when the only communication to a device is for user-initiated interactive access.

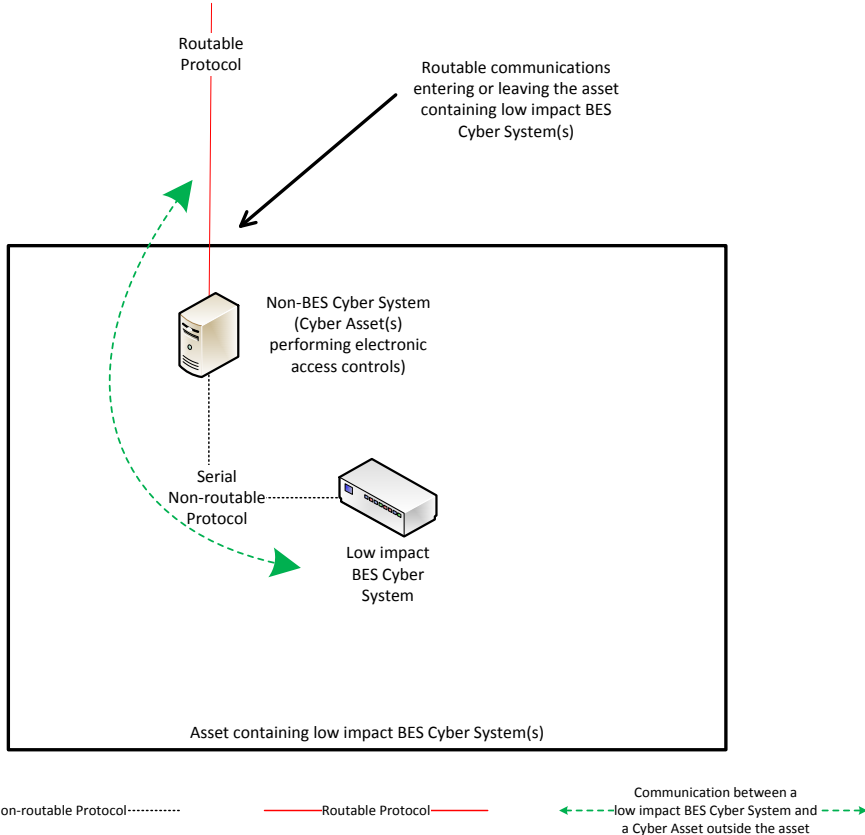

Reference Model 5

**Reference Model 6 – Indirect Access**

In implementing its electronic access controls, the Responsible Entity may identify that it has indirect access between the low impact BES Cyber System and a Cyber Asset outside the asset containing the low impact BES Cyber System through a non-BES Cyber Asset located within the asset. This indirect access meets the criteria of having communication between the low impact BES Cyber System and a Cyber Asset outside the asset containing the low impact BES Cyber System. In this reference model, it is intended that the Responsible Entity implement electronic access controls that permit only necessary inbound and outbound electronic access to the low impact BES Cyber System. Consistent with the other reference models provided, the electronic access in this reference model is controlled using the security device that is restricting the communication that is entering or leaving the asset.

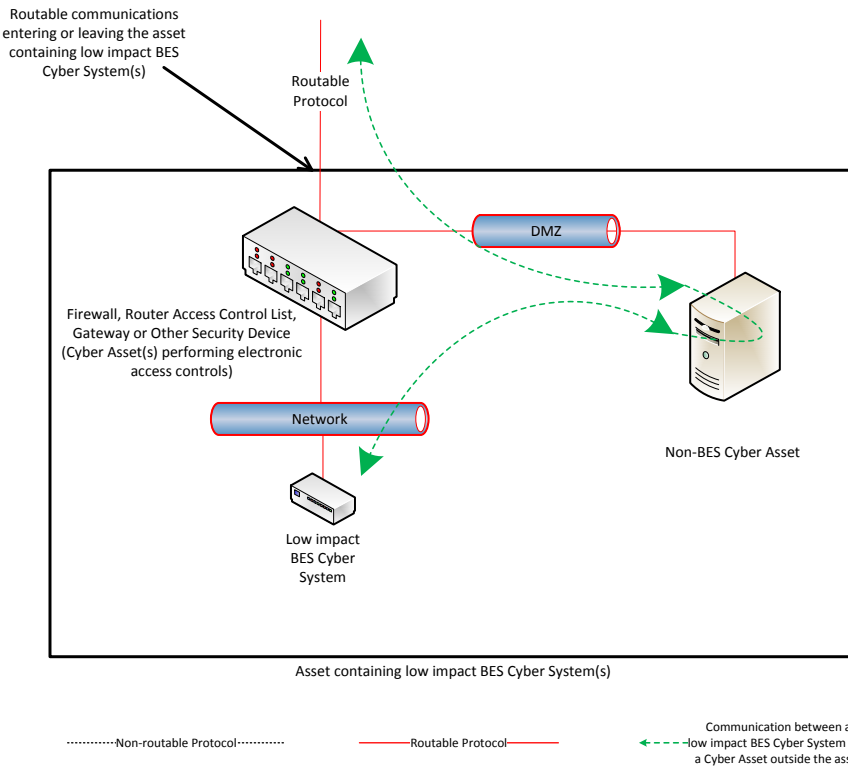

*Reference Model 6*

**Reference Model 7 – Electronic Access Controls at assets containing low impact BES Cyber Systems and ERC**

In this reference model, there is both a routable protocol entering and leaving the asset containing the low impact BES Cyber System(s) that is used by Cyber Asset(s) outside the asset and External Routable Connectivity because there is at least one medium impact BES Cyber System and one low impact BES Cyber System within the asset using the routable protocol communications. The Responsible Entity may choose to leverage an interface on the medium impact Electronic Access Control or Monitoring Systems (EACMS) to provide electronic access controls for purposes of CIP-003. The EACMS is therefore performing multiple functions – as a medium impact EACMS and as implementing electronic access controls for an asset containing low impact BES Cyber Systems.

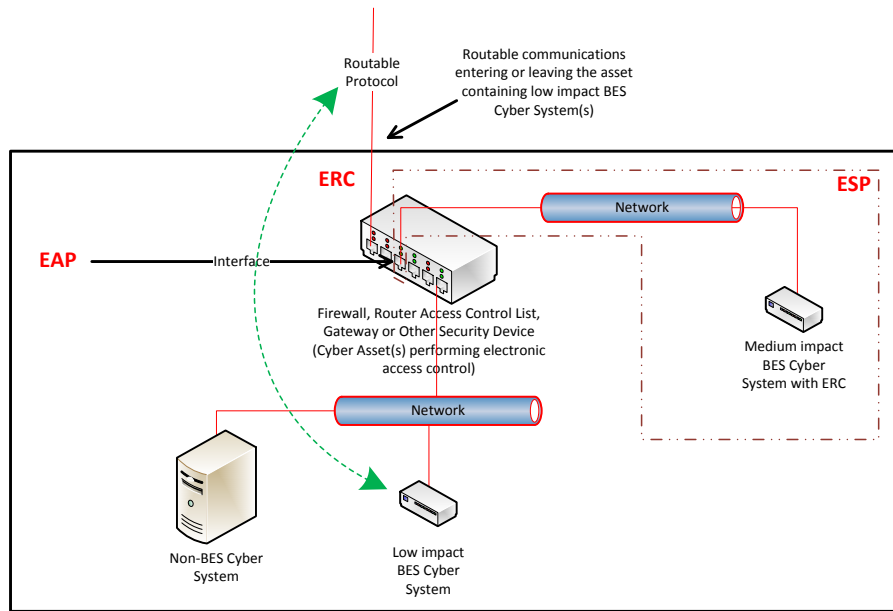

Asset containing low impact BES Cyber System(s) and medium impact BES Cyber System(s)

.....Non-routable Protocol.....      — Routable Protocol —      ← - - - - low impact BES Cyber System and a Cyber Asset outside the asset - - - - →

Reference Model 7

**Reference Model 8 – Physical Isolation and Serial Non-routable Communications – No Electronic Access Controls Required**

In this reference model, the criteria from Attachment 1, Section 3.1 requiring the implementation of electronic access controls are not met. This reference model demonstrates three concepts:

- 1) The physical isolation of the low impact BES Cyber System(s) from the routable protocol communication entering or leaving the asset containing the low impact BES Cyber System(s), commonly referred to as an ‘air gap’, mitigates the need to implement the required electronic access controls;
- 2) The communication to the low impact BES Cyber System from a Cyber Asset outside the asset containing the low impact BES Cyber System(s) using only a serial non-routable protocol where such communication is entering or leaving the asset mitigates the need to implement the required electronic access controls.
- 3) The routable protocol communication between the low impact BES Cyber System(s) and other Cyber Asset(s), such as the second low impact BES Cyber System depicted, may exist without needing to implement the required electronic access controls so long as the routable protocol communications never leaves the asset containing the low impact BES Cyber System(s).

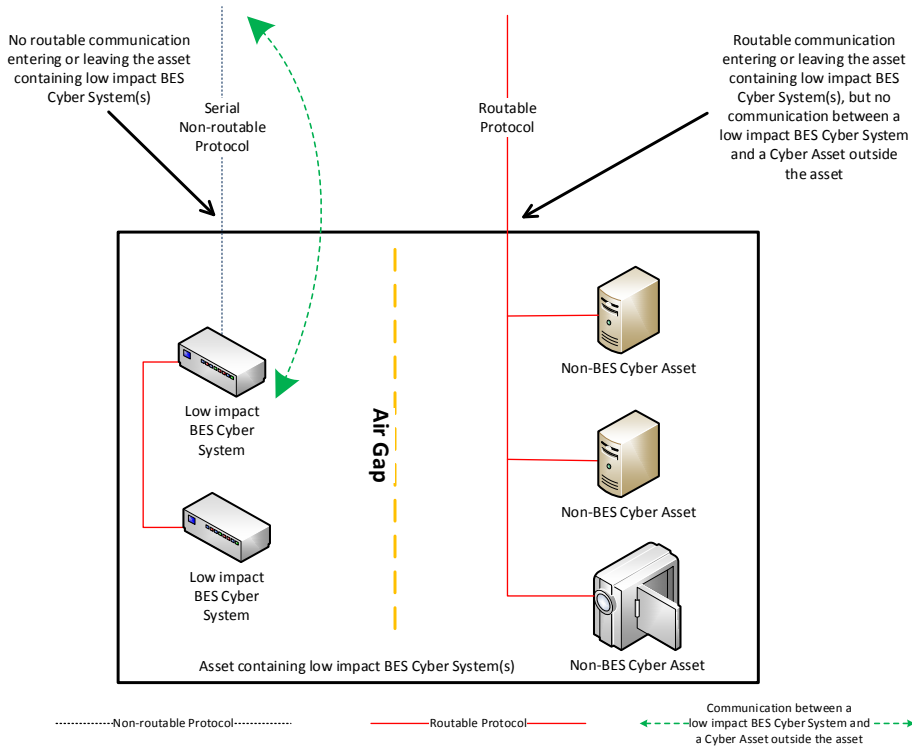

Reference Model 8

**Reference Model 9 – Logical Isolation - No Electronic Access Controls Required**

In this reference model, the criteria from Attachment 1, Section 3.1 requiring the implementation of electronic access controls are not met. The Responsible Entity has logically isolated the low impact BES Cyber System(s) from the routable protocol communication entering or leaving the asset containing low impact BES Cyber System(s). The logical network segmentation in this reference model permits no communication between a low impact BES Cyber System and a Cyber Asset outside the asset. Additionally, no indirect access exists because those non-BES Cyber Assets that are able to communicate outside the asset are strictly prohibited from communicating to the low impact BES Cyber System(s). The low impact BES Cyber System(s) is on an isolated network segment with logical controls preventing routable protocol communication into or out of the network containing the low impact BES Cyber System(s) and these communications never leave the asset using a routable protocol.



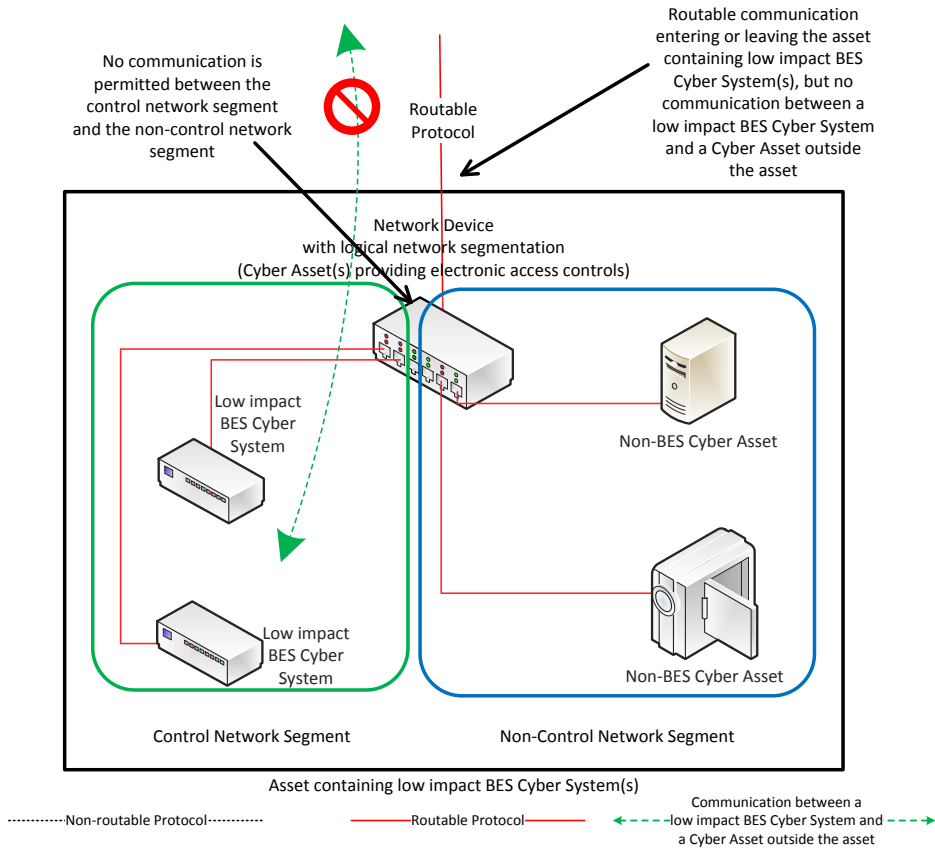

Reference Model 9

**Reference Model 10 - Serial Non-routable Communications Traversing an Isolated Channel on a Non-routable Transport Network – No Electronic Access Controls Required**

In this reference model, the criteria from Attachment 1, Section 3.1 requiring the implementation of electronic access controls are not met. This reference model depicts communication between a low impact BES Cyber System and a Cyber Asset outside the asset containing the low impact BES Cyber System over a serial non-routable protocol which is transported across a wide-area network using a protocol independent transport that may carry routable and non-routable communication such as a Time-Division Multiplexing (TDM) network, a Synchronous Optical Network (SONET), or a Multiprotocol Label Switching (MPLS) network. While there is routable protocol communication entering or leaving the asset containing low impact BES Cyber Systems(s) and there is communication between a low impact BES Cyber System and a Cyber Asset outside the asset, the communication between the low impact BES Cyber System and the Cyber Asset outside the asset is not using the routable protocol communication. This model is related to Reference Model 9 in that it relies on logical isolation to prohibit the communication between a low impact BES Cyber System and a Cyber Asset outside the asset from using a routable protocol.

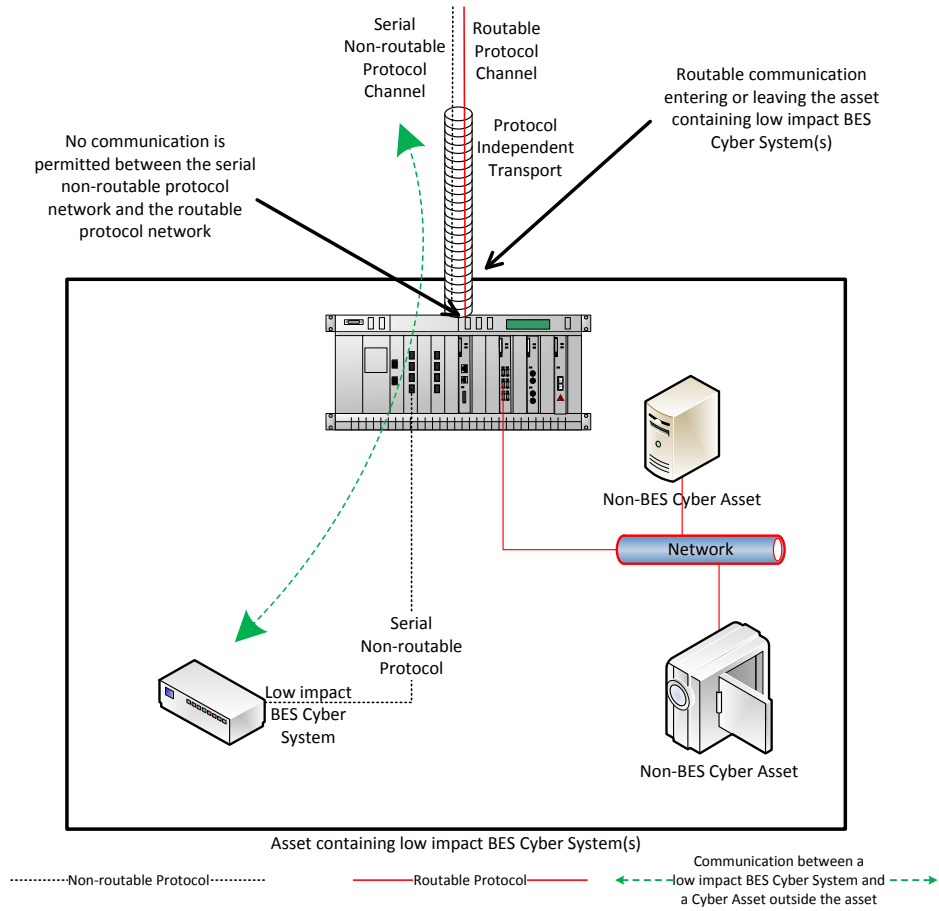

Reference Model 10

### Dial-up Connectivity

Dial-up Connectivity to a low impact BES Cyber System is set to dial out only (no auto-answer) to a preprogrammed number to deliver data. Incoming Dial-up Connectivity is to a dialback modem, a modem that must be remotely controlled by the control center or control room, has some form of access control, or the low impact BES Cyber System has access control.

### Insufficient Access Controls

Some examples of situations that would lack sufficient access controls to meet the intent of this requirement include:

- An asset has Dial-up Connectivity and a low impact BES Cyber System is reachable via an auto-answer modem that connects any caller to the Cyber Asset that has a default password. There is no practical access control in this instance.
- A low impact BES Cyber System has a wireless card on a public carrier that allows the BES Cyber System to be reachable via a public IP address. In essence, low impact BES Cyber Systems should not be accessible from the Internet and search engines such as Shodan.
- Dual-homing or multiple-network interface cards without disabling IP forwarding in the non-BES Cyber Asset within the DMZ to provide separation between the low impact BES Cyber System(s) and the external network would not meet the intent of “controlling” inbound and outbound electronic access assuming there was no other host-based firewall or other security devices on the non-BES Cyber Asset.

### Requirement R2, Attachment 1, Section 4 – Cyber Security Incident Response

The entity should have one or more documented Cyber Security Incident response plan(s) that include each of the topics listed in Section 4. If, in the normal course of business, suspicious activities are noted at an asset containing low impact BES Cyber System(s), the intent is for the entity to implement a Cyber Security Incident response plan that will guide the entity in responding to the incident and reporting the incident if it rises to the level of a Reportable Cyber Security Incident.

Entities are provided the flexibility to develop their Attachment 1, Section 4 Cyber Security Incident response plan(s) by asset or group of assets. The plans do not need to be on a per asset site or per low impact BES Cyber System basis. Entities can choose to use a single enterprise-wide plan to fulfill the obligations for low impact BES Cyber Systems.

The plan(s) must be tested once every 36 months. This is not an exercise per low impact BES Cyber Asset or per type of BES Cyber Asset but rather is an exercise of each incident response plan the entity created to meet this requirement. An actual Reportable Cyber Security Incident counts as an exercise as do other forms of tabletop exercises or drills. NERC-led exercises such as GridEx participation would also count as an exercise provided the entity’s response plan is followed. The intent of the requirement is for entities to keep the Cyber Security Incident response plan(s) current, which includes updating the plan(s), if needed, within 180 days following a test or an actual incident.

For low impact BES Cyber Systems, the only portion of the definition of Cyber Security Incident that would apply is, “A malicious act or suspicious event that disrupts, or was an attempt to disrupt, the operation of a BES Cyber System.” The other portion of that definition is not to be used to require ESPs and PSPs for low impact BES Cyber Systems.

**Requirement R2, Attachment 1, Section 5 – Transient Cyber Assets and Removable Media Malicious Code Risk Mitigation**

Most BES Cyber Assets and BES Cyber Systems are isolated from external public or untrusted networks, and therefore Transient Cyber Assets and Removable Media are needed to transport files to and from secure areas to maintain, monitor, or troubleshoot critical systems. Transient Cyber Assets and Removable Media are a potential means for cyber-attack. To protect the BES Cyber Assets and BES Cyber Systems, CIP-003 Requirement R2, Attachment 1, Section 5 requires Responsible Entities to document and implement a plan for how they will mitigate the risk of malicious code introduction to low impact BES Cyber Systems from Transient Cyber Assets and Removable Media. The approach of defining a plan allows the Responsible Entity to document processes that are supportable within its organization and in alignment with its change management processes.

Transient Cyber Assets can be one of many types of devices from a specially-designed device for maintaining equipment in support of the BES to a platform such as a laptop, desktop, or tablet that may interface with or run applications that support BES Cyber Systems and is capable of transmitting executable code to the BES Cyber Asset(s) or BES Cyber System(s). Note: Cyber Assets connected to a BES Cyber System for less than 30 days due to an unplanned removal, such as premature failure, are not intended to be identified as Transient Cyber Assets. Removable Media subject to this requirement include, among others, floppy disks, compact disks, USB flash drives, external hard drives, and other flash memory cards/drives that contain nonvolatile memory.

Examples of these temporarily connected devices include, but are not limited to:

- Diagnostic test equipment;
- Equipment used for BES Cyber System maintenance; or
- Equipment used for BES Cyber System configuration.

To meet the objective of mitigating risks associated with the introduction of malicious code at low impact BES Cyber Systems, Section 5 specifies the capabilities and possible security methods available to Responsible Entities based upon asset type and ownership.

With the list of options provided in Attachment 1, the entity has the discretion to use the option(s) that is most appropriate. This includes documenting its approach for how and when the entity reviews the Transient Cyber Asset under its control or under the control of parties other than the Responsible Entity. The entity should avoid implementing a security function that jeopardizes reliability by taking actions that would negatively impact the performance or support of the Transient Cyber Asset or BES Cyber Asset.

#### Malicious Code Risk Mitigation

The terms “mitigate”, “mitigating”, and “mitigation” are used in Section 5 in Attachment 1 to address the risks posed by malicious code when connecting Transient Cyber Assets and Removable Media to BES Cyber Systems. Mitigation is intended to mean that entities reduce security risks presented by connecting the Transient Cyber Asset or Removable Media. When determining the method(s) to mitigate the introduction of malicious code, it is not intended for entities to perform and document a formal risk assessment associated with the introduction of malicious code.

#### Per Transient Cyber Asset Capability

As with other CIP standards, the requirements are intended for an entity to use the method(s) that the system is capable of performing. The use of “per Transient Cyber Asset capability” is to eliminate the need for a Technical Feasibility Exception when it is understood that the device cannot use a method(s). For example, for malicious code, many types of appliances are not capable of implementing antivirus software; therefore, because it is not a capability of those types of devices, implementation of the antivirus software would not be required for those devices.

#### **Requirement R2, Attachment 1, Section 5.1 - Transient Cyber Asset(s) Managed by the Responsible Entity**

For Transient Cyber Assets and Removable Media that are connected to both low impact and medium/high impact BES Cyber Systems, entities must be aware of the differing levels of requirements and manage these assets under the program that matches the highest impact level to which they will connect.

**Section 5.1:** Entities are to document and implement their plan(s) to mitigate malicious code through the use of one or more of the protective measures listed, based on the capability of the Transient Cyber Asset.

The Responsible Entity has the flexibility to apply the selected method(s) to meet the objective of mitigating the introductions of malicious code either in an on-going or in an on-demand manner. An example of managing a device in an on-going manner is having the antivirus solution for the device managed as part of an end-point security solution with current signature or pattern updates, regularly scheduled systems scans, etc. In contrast, for devices that are used infrequently and the signatures or patterns are not kept current, the entity may manage those devices in an on-demand manner by requiring an update to the signatures or patterns and a scan of the device before the device is connected to ensure that it is free of malicious code.

Selecting management in an on-going or on-demand manner is not intended to imply that the control has to be verified at every single connection. For example, if the device is managed in an on-demand manner, but will be used to perform maintenance on several BES Cyber Asset(s), the Responsible Entity may choose to document that the Transient Cyber Asset has been updated before being connected as a Transient Cyber Asset for the first use of that maintenance work. The intent is not to require a log documenting each connection of a Transient Cyber Asset to a BES Cyber Asset.

The following is additional discussion of the methods to mitigate the introduction of malicious code.

- Antivirus software, including manual or managed updates of signatures or patterns, provides flexibility to manage Transient Cyber Asset(s) by deploying antivirus or endpoint security tools that maintain a scheduled update of the signatures or patterns. Also, for devices that do not regularly connect to receive scheduled updates, entities may choose to update the signatures or patterns and scan the Transient Cyber Asset prior to connection to ensure no malicious software is present.
- Application whitelisting is a method of authorizing only the applications and processes that are necessary on the Transient Cyber Asset. This reduces the risk that malicious software could execute on the Transient Cyber Asset and impact the BES Cyber Asset or BES Cyber System.
- When using methods other than those listed, entities need to document how the other method(s) meet the objective of mitigating the risk of the introduction of malicious code.

If malicious code is discovered on the Transient Cyber Asset, it must be mitigated prior to connection to a BES Cyber System to prevent the malicious code from being introduced into the BES Cyber System. An entity may choose to not connect the Transient Cyber Asset to a BES Cyber System to prevent the malicious code from being introduced into the BES Cyber System. Entities should also consider whether the detected malicious code is a Cyber Security Incident.

**Requirement R2, Attachment 1, Section 5.2 - Transient Cyber Asset(s) Managed by a Party Other than the Responsible Entity**

Section 5 also recognizes the lack of direct control over Transient Cyber Assets that are managed by parties other than the Responsible Entity. This lack of control, however, does not obviate the Responsible Entity's responsibility to ensure that methods have been deployed to mitigate the introduction of malicious code to low impact BES Cyber System(s) from Transient Cyber Assets it does not manage. Section 5 requires entities to review the other party's security practices with respect to Transient Cyber Assets to help meet the objective of the requirement. The use of "prior to connecting the Transient Cyber Assets" is intended to ensure that the Responsible Entity conducts the review before the first connection of the Transient Cyber Asset to help meet the objective to mitigate the introduction of malicious code. The SDT does not intend for the Responsible Entity to conduct a review for every single connection of that Transient Cyber Asset once the Responsible Entity has established the Transient Cyber Asset is meeting the security objective. The intent is to not require a log documenting each connection of a Transient Cyber Asset to a BES Cyber Asset.

To facilitate these controls, Responsible Entities may execute agreements with other parties to provide support services to BES Cyber Systems and BES Cyber Assets that may involve the use of Transient Cyber Assets. Entities may consider using the Department of Energy Cybersecurity

## CIP-003-87 Supplemental Material

---

Procurement Language for Energy Delivery dated April 2014.<sup>1</sup> Procurement language may unify the other party and entity actions supporting the BES Cyber Systems and BES Cyber Assets. CIP program attributes may be considered including roles and responsibilities, access controls, monitoring, logging, vulnerability, and patch management along with incident response and back up recovery may be part of the other party's support. Entities may consider the "General Cybersecurity Procurement Language" and "The Supplier's Life Cycle Security Program" when drafting Master Service Agreements, Contracts, and the CIP program processes and controls.

**Section 5.2.1:** Entities are to document and implement their process(es) to mitigate the introduction of malicious code through the use of one or more of the protective measures listed.

- Review the use of antivirus software and signature or pattern levels to ensure that the level is adequate to the Responsible Entity to mitigate the risk of malicious software being introduced to an applicable system.
- Review the antivirus or endpoint security processes of the other party to ensure that their processes are adequate to the Responsible Entity to mitigate the risk of introducing malicious software to an applicable system.
- Review the use of application whitelisting used by the other party to mitigate the risk of introducing malicious software to an applicable system.
- Review the use of live operating systems or software executable only from read-only media to ensure that the media is free from malicious software itself. Entities should review the processes to build the read-only media as well as the media itself.
- Review system hardening practices used by the other party to ensure that unnecessary ports, services, applications, etc. have been disabled or removed. This method intends to reduce the attack surface on the Transient Cyber Asset and reduce the avenues by which malicious software could be introduced.

**Section 5.2.2:** The intent of this section is to ensure that after conducting the selected review from Section 5.2.1, if there are deficiencies identified, actions mitigating the risk of the introduction of malicious code to low impact BES Cyber Systems must be completed prior to connecting the device(s) to an applicable system.

### **Requirement R2, Attachment 1, Section 5.3 - Removable Media**

Entities have a high level of control for Removable Media that are going to be connected to their BES Cyber Assets.

---

<sup>1</sup> <http://www.energy.gov/oe/downloads/cybersecurity-procurement-language-energy-delivery-april-2014>

Formatted: Space Before: 0 pt

Formatted: Font: 9 pt



**Section 5.3:** Entities are to document and implement their process(es) to mitigate the introduction of malicious code through the use of one or more method(s) to detect malicious code on the Removable Media before it is connected to a BES Cyber Asset. When using the method(s) to detect malicious code, it is expected to occur from a system that is not part of the BES Cyber System to reduce the risk of propagating malicious code into the BES Cyber System network or onto one of the BES Cyber Assets. If malicious code is discovered, it must be removed or mitigated to prevent it from being introduced into the BES Cyber Asset or BES Cyber System. Entities should also consider whether the detected malicious code is a Cyber Security Incident. Frequency and timing of the methods used to detect malicious code were intentionally excluded from the requirement because there are multiple timing scenarios that can be incorporated into a plan to mitigate the risk of malicious code. The SDT does not intend to obligate a Responsible Entity to conduct a review for every single connection of Removable Media, but rather to implement its plan(s) in a manner that protects all BES Cyber Systems where Removable Media may be used. The intent is to not require a log documenting each connection of Removable Media to a BES Cyber Asset.

As a method to detect malicious code, entities may choose to use Removable Media with on-board malicious code detection tools. For these tools, the Removable Media are still used in conjunction with a Cyber Asset to perform the detection. For Section 5.3.1, the Cyber Asset used to perform the malicious code detection must be outside of the BES Cyber System.

**Requirement R3:**

The intent of CIP-003-87, Requirement R3 is effectively unchanged since prior versions of the standard. The specific description of the CIP Senior Manager has now been included as a defined term rather than clarified in the Reliability Standard itself to prevent any unnecessary cross-reference to this standard. It is expected that the CIP Senior Manager will play a key role in ensuring proper strategic planning, executive/board-level awareness, and overall program governance.

**Requirement R4:**

As indicated in the rationale for CIP-003-87, Requirement R4, this requirement is intended to demonstrate a clear line of authority and ownership for security matters. The intent of the SDT was not to impose any particular organizational structure, but, rather, the intent is to afford the Responsible Entity significant flexibility to adapt this requirement to its existing organizational structure. A Responsible Entity may satisfy this requirement through a single delegation document or through multiple delegation documents. The Responsible Entity can make use of the delegation of the delegation authority itself to increase the flexibility in how this applies to its organization. In such a case, delegations may exist in numerous documentation records as long as the collection of these documentation records shows a clear line of authority back to the CIP Senior Manager. In addition, the CIP Senior Manager could also choose not to delegate any authority and meet this requirement without such delegation documentation.

The Responsible Entity must keep its documentation of the CIP Senior Manager and any delegations up-to-date. This is to ensure that individuals do not assume any undocumented

## CIP-003-~~87~~ Supplemental Material

---

authority. However, delegations do not have to be re-instated if the individual who delegated the task changes roles or the individual is replaced. For instance, assume that John Doe is named the CIP Senior Manager and he delegates a specific task to the Substation Maintenance Manager. If John Doe is replaced as the CIP Senior Manager, the CIP Senior Manager documentation must be updated within the specified timeframe, but the existing delegation to the Substation Maintenance Manager remains in effect as approved by the previous CIP Senior Manager, John Doe.

**Rationale:**

During development of this standard, text boxes were embedded within the standard to explain the rationale for various parts of the standard. Upon BOT approval, the text from the rationale text boxes was moved to this section.

**Rationale for Requirement R1:**

One or more security policies enable effective implementation of the requirements of the cyber security Reliability Standards. The purpose of policies is to provide a management and governance foundation for all requirements that apply to a Responsible Entity's BES Cyber Systems. The Responsible Entity can demonstrate through its policies that its management supports the accountability and responsibility necessary for effective implementation of the requirements.

Annual review and approval of the cyber security policies ensures that the policies are kept-up-to-date and periodically reaffirms management's commitment to the protection of its BES Cyber Systems.

**Rationale for Requirement R2:**

In response to FERC Order No. 791, Requirement R2 requires entities to develop and implement cyber security plans to meet specific security control objectives for assets containing low impact BES Cyber System(s). The cyber security plan(s) covers five subject matter areas: (1) cyber security awareness; (2) physical security controls; (3) electronic access controls; (4) Cyber Security Incident response; and (5) Transient Cyber Asset and Removable Media Malicious Code Risk Mitigation. This plan(s), along with the cyber security policies required under Requirement R1, Part 1.2, provides a framework for operational, procedural, and technical safeguards for low impact BES Cyber Systems.

Considering the varied types of low impact BES Cyber Systems across the BES, Attachment 1 provides Responsible Entities flexibility on how to apply the security controls to meet the security objectives. Additionally, because many Responsible Entities have multiple-impact rated BES Cyber Systems, nothing in the requirement prohibits entities from using their high and medium impact BES Cyber System policies, procedures, and processes to implement security controls required for low impact BES Cyber Systems, as detailed in Requirement R2, Attachment 1.

Responsible Entities will use their identified assets containing low impact BES Cyber System(s) (developed pursuant to CIP-002) to substantiate the sites or locations associated with low impact BES Cyber System(s). However, there is no requirement or compliance expectation for Responsible Entities to maintain a list(s) of individual low impact BES Cyber System(s) and their associated cyber assets or to maintain a list of authorized users.

**Rationale for Modifications to Sections 2 and 3 of Attachment 1 (Requirement R2):**

Requirement R2 mandates that entities develop and implement one or more cyber security plan(s) to meet specific security objectives for assets containing low impact BES Cyber System(s). In Paragraph 73 of FERC Order No. 822, the Commission directed NERC to modify "...the Low Impact External Routable Connectivity definition to reflect the commentary in the Guidelines and Technical Basis section of CIP-003-6...to provide needed clarity to the definition

and eliminate ambiguity surrounding the term ‘direct’ as it is used in the proposed definition...within one year of the effective date of this Final Rule.”

The revisions to Section 3 incorporate select language from the LERC definition into Attachment 1 and focus the requirement on implementing electronic access controls for asset(s) containing low impact BES Cyber System(s). This change requires the Responsible Entity to permit only necessary inbound and outbound electronic access when using a routable protocol entering or leaving the asset between low impact BES Cyber System(s) and a Cyber Asset(s) outside the asset containing low impact BES Cyber system(s). When this communication is present, Responsible Entities are required to implement electronic access controls unless that communication meets the following exclusion language (previously in the definition of LERC) contained in romanette (iii): “not used for time-sensitive protection or control functions between intelligent electronic devices (e.g. communications using protocol IEC TR-61850-90-5 R-GOOSE)”.

The revisions to Section 2 of Attachment 1 complement the revisions to Section 3; consequently, the requirement now mandates the Responsible Entity control physical access to “the Cyber Asset(s), as specified by the Responsible Entity, that provide electronic access control(s) implemented for Section 3.1, if any.” The focus on electronic access controls rather than on the Low Impact BES Cyber System Electronic Access Points (LEAPs) eliminates the need for LEAPs.

Given these revisions to Sections 2 and 3, the NERC Glossary terms: Low Impact External Routable Connectivity (LERC) and Low Impact BES Cyber System Electronic Access Point (LEAP) will be retired.

**Rationale for Section 5 of Attachment 1 (Requirement R2):**

Requirement R2 mandates that entities develop and implement one or more cyber security plan(s) to meet specific security objectives for assets containing low impact BES Cyber System(s). In Paragraph 32 of FERC Order No. 822, the Commission directed NERC to “...provide mandatory protection for transient devices used at Low Impact BES Cyber Systems based on the risk posed to bulk electric system reliability.” Transient devices are potential vehicles for introducing malicious code into low impact BES Cyber Systems. Section 5 of Attachment 1 is intended to mitigate the risk of malware propagation to the BES through low impact BES Cyber Systems by requiring entities to develop and implement one or more plan(s) to address the risk. The cyber security plan(s) along with the cyber security policies required under Requirement R1, Part 1.2, provide a framework for operational, procedural, and technical safeguards for low impact BES Cyber Systems.

**Rationale for Requirement R3:**

The identification and documentation of the single CIP Senior Manager ensures that there is clear authority and ownership for the CIP program within an organization, as called for in Blackout Report Recommendation 43. The language that identifies CIP Senior Manager responsibilities is included in the Glossary of Terms used in NERC Reliability Standards so that it may be used across the body of CIP standards without an explicit cross-reference.

## CIP-003-~~87~~ Supplemental Material

---

FERC Order No. 706, Paragraph 296, requests consideration of whether the single senior manager should be a corporate officer or equivalent. As implicated through the defined term, the senior manager has “the overall authority and responsibility for leading and managing implementation of the requirements within this set of standards” which ensures that the senior manager is of sufficient position in the Responsible Entity to ensure that cyber security receives the prominence that is necessary. In addition, given the range of business models for responsible entities, from municipal, cooperative, federal agencies, investor owned utilities, privately owned utilities, and everything in between, the SDT believes that requiring the CIP Senior Manager to be a “corporate officer or equivalent” would be extremely difficult to interpret and enforce on a consistent basis.

### **Rationale for Requirement R4:**

The intent of the requirement is to ensure clear accountability within an organization for certain security matters. It also ensures that delegations are kept up-to-date and that individuals do not assume undocumented authority.

In FERC Order No. 706, Paragraphs 379 and 381, the Commission notes that Recommendation 43 of the 2003 Blackout Report calls for “clear lines of authority and ownership for security matters.” With this in mind, the Standard Drafting Team has sought to provide clarity in the requirement for delegations so that this line of authority is clear and apparent from the documented delegations.

# Implementation Plan

## Project 2016-02 Modifications to CIP Standards Reliability Standard CIP-003-8 - Cyber Security – Security Management Controls

### Applicable Standard

- Reliability Standard CIP-003-8 - Cyber Security – Security Management Controls

### Requested Retirements

- Reliability Standard CIP-003-7 - Cyber Security – Security Management Controls

### Applicable Entities

- Balancing Authority
- Distribution Provider
- Generator Operator
- Generator Owner
- Reliability Coordinator
- Transmission Operator
- Transmission Owner

### Background

On April 19, 2018, the Federal Energy Regulatory Commission (the “Commission”) issued Order No. 843, approving CIP-003-7. In that Order, the Commission also directed NERC to “develop and submit modifications to Reliability Standard CIP-003-7 to include an explicit requirement that responsible entities implement controls to mitigate the risk of malicious code that could result from third-party transient electronic devices.”

### Effective Dates

#### Reliability Standard CIP-003-8

Where approval by an applicable governmental authority is required, Reliability Standard CIP-003-8 shall become effective on the later of (1) January 1, 2020, or (2) the first day of the first calendar quarter that is six (6) calendar months after the effective date of the applicable governmental authority’s order approving the standard, or as otherwise provided for by the applicable governmental authority.

Where approval by an applicable governmental authority is not required, Reliability Standard CIP-003-8 shall become effective on the later of (1) January 1, 2020, or (2) the first day of the first

calendar quarter that is six (6) calendar months after the date the standard is adopted by the NERC Board of Trustees, or as otherwise provided for in that jurisdiction.

### **Planned or Unplanned Changes**

This Implementation Plan incorporates by reference the section in the [Implementation Plan](#) associated with CIP-003-7 titled Planned or Unplanned Changes.

Note that NERC is currently developing provisions related to Planned or Unplanned Changes to be included in the CIP-002 standard that would apply to all applicable CIP Reliability Standards and would supersede the Planned and Unplanned Changes provisions in the Implementation Plan associated with CIP-003-7.

### **Retirement Date**

#### **Reliability Standard CIP-003-7**

Reliability Standard CIP-003-7 shall be retired immediately prior to the effective date of Reliability Standard CIP-003-8 in the particular jurisdiction in which the revised standard is becoming effective.

# Implementation Plan

## Project 2016-02 Modifications to CIP Standards Reliability Standard CIP-003-8 - Cyber Security – Security Management Controls

### Applicable Standard

- Reliability Standard CIP-003-8 - Cyber Security – Security Management Controls

### Requested Retirements

- Reliability Standard CIP-003-7 - Cyber Security – Security Management Controls

### Applicable Entities

- Balancing Authority
- Distribution Provider
- Generator Operator
- Generator Owner
- Reliability Coordinator
- Transmission Operator
- Transmission Owner

### Background

On April 19, 2018, the Federal Energy Regulatory Commission (the “Commission”) issued Order No. 843, approving CIP-003-7. In that Order, the Commission also directed NERC to “develop and submit modifications to Reliability Standard CIP-003-7 to include an explicit requirement that responsible entities implement controls to mitigate the risk of malicious code that could result from third-party transient electronic devices.”

### Effective Dates

#### Reliability Standard CIP-003-8

Where approval by an applicable governmental authority is required, Reliability Standard CIP-003-8 shall become effective on the later of (1) January 1, 2020, or (2) the first day of the first calendar quarter that is six (6) calendar months after the effective date of the applicable governmental authority’s order approving the standard, or as otherwise provided for by the applicable governmental authority.

Where approval by an applicable governmental authority is not required, Reliability Standard CIP-003-8 shall become effective on the later of (1) January 1, 2020, or (2) the first day of the first



calendar quarter that is six (6) calendar months after the date the standard is adopted by the NERC Board of Trustees, or as otherwise provided for in that jurisdiction.

### **Planned or Unplanned Changes**

This Implementation Plan incorporates by reference the section in the Implementation Plan associated with CIP-003-7 titled Planned or Unplanned Changes.

Note that NERC is currently developing provisions related to Planned or Unplanned Changes to be included in the CIP-002 standard that would apply to all applicable CIP Reliability Standards and would supersede the Planned and Unplanned Changes provisions in the Implementation Plan associated with CIP-003-7.

### **Retirement Date**

#### **Reliability Standard CIP-003-7**

Reliability Standard CIP-003-7 shall be retired immediately prior to the effective date of Reliability Standard CIP-003-8 in the particular jurisdiction in which the revised standard is becoming effective.

# Violation Risk Factor and Violation Severity Level Justifications

## Project 2016-02 – Modifications to CIP Standards

This document provides the standard drafting team's (SDT's) justification for assignment of the violation risk factor (VRF) and violation severity levels (VSLs) in proposed NERC Reliability Standard CIP-003-8 — Cyber Security — Security Management Controls. These elements support the determination of an initial value range for the Base Penalty Amount regarding violations of requirements in FERC-approved Reliability Standards, as defined in the Electric Reliability Organizations (ERO) Sanction Guidelines. The SDT applied the following NERC criteria and FERC Guidelines when developing the VRFs and VSLs for the requirements.

### **NERC Criteria for Violation Risk Factors**

#### **High Risk Requirement**

A requirement that, if violated, could directly cause or contribute to Bulk Electric System instability, separation, or a cascading sequence of failures, or could place the Bulk Electric System at an unacceptable risk of instability, separation, or cascading failures; or, a requirement in a planning time frame that, if violated, could, under emergency, abnormal, or restorative conditions anticipated by the preparations, directly cause or contribute to Bulk Electric System instability, separation, or a cascading sequence of failures, or could place the Bulk Electric System at an unacceptable risk of instability, separation, or cascading failures, or could hinder restoration to a normal condition.

#### **Medium Risk Requirement**

A requirement that, if violated, could directly affect the electrical state or the capability of the Bulk Electric System, or the ability to effectively monitor and control the Bulk Electric System. However, violation of a medium risk requirement is unlikely to lead to Bulk Electric System instability, separation, or cascading failures; or, a requirement in a planning time frame that, if violated, could, under emergency, abnormal, or restorative conditions anticipated by the preparations, directly and adversely affect the electrical state or capability of the Bulk Electric System, or the ability to effectively monitor, control, or restore the Bulk Electric System. However, violation of a medium risk requirement is unlikely, under emergency, abnormal, or restoration conditions anticipated by the preparations, to lead to Bulk Electric System instability, separation, or cascading failures, nor to hinder restoration to a normal condition.

### Lower Risk Requirement

A requirement that is administrative in nature and a requirement that, if violated, would not be expected to adversely affect the electrical state or capability of the Bulk Electric System, or the ability to effectively monitor and control the Bulk Electric System; or, a requirement that is administrative in nature and a requirement in a planning time frame that, if violated, would not, under the emergency, abnormal, or restorative conditions anticipated by the preparations, be expected to adversely affect the electrical state or capability of the Bulk Electric System, or the ability to effectively monitor, control, or restore the Bulk Electric System.

## FERC Guidelines for Violation Risk Factors

### Guideline (1) – Consistency with the Conclusions of the Final Blackout Report

FERC seeks to ensure that VRFs assigned to Requirements of Reliability Standards in these identified areas appropriately reflect their historical critical impact on the reliability of the Bulk-Power System. In the VSL Order, FERC listed critical areas (from the Final Blackout Report) where violations could severely affect the reliability of the Bulk-Power System:

- Emergency operations
- Vegetation management
- Operator personnel training
- Protection systems and their coordination
- Operating tools and backup facilities
- Reactive power and voltage control
- System modeling and data exchange
- Communication protocol and facilities
- Requirements to determine equipment ratings
- Synchronized data recorders
- Clearer criteria for operationally critical facilities
- Appropriate use of transmission loading relief.

**Guideline (2) – Consistency within a Reliability Standard**

FERC expects a rational connection between the sub-Requirement VRF assignments and the main Requirement VRF assignment.

**Guideline (3) – Consistency among Reliability Standards**

FERC expects the assignment of VRFs corresponding to Requirements that address similar reliability goals in different Reliability Standards would be treated comparably.

**Guideline (4) – Consistency with NERC’s Definition of the Violation Risk Factor Level**

Guideline (4) was developed to evaluate whether the assignment of a particular VRF level conforms to NERC’s definition of that risk level.

**Guideline (5) – Treatment of Requirements that Co-mingle More Than One Obligation**

Where a single Requirement co-mingles a higher risk reliability objective and a lesser risk reliability objective, the VRF assignment for such Requirements must not be watered down to reflect the lower risk level associated with the less important objective of the Reliability Standard.

## NERC Criteria for Violation Severity Levels

VSLs define the degree to which compliance with a requirement was not achieved. Each requirement must have at least one VSL. While it is preferable to have four VSLs for each requirement, some requirements do not have multiple “degrees” of noncompliant performance and may have only one, two, or three VSLs.

VSLs should be based on NERC’s overarching criteria shown in the table below:

Lower VSL	Moderate VSL	High VSL	Severe VSL
The performance or product measured almost meets the full intent of the requirement.	The performance or product measured meets the majority of the intent of the requirement.	The performance or product measured does not meet the majority of the intent of the requirement, but does meet some of the intent.	The performance or product measured does not substantively meet the intent of the requirement.

## FERC Order of Violation Severity Levels

The FERC VSL guidelines are presented below, followed by an analysis of whether the VSLs proposed for each requirement in the standard meet the FERC Guidelines for assessing VSLs:

### Guideline (1) – Violation Severity Level Assignments Should Not Have the Unintended Consequence of Lowering the Current Level of Compliance

Compare the VSLs to any prior levels of non-compliance and avoid significant changes that may encourage a lower level of compliance than was required when levels of non-compliance were used.

### Guideline (2) – Violation Severity Level Assignments Should Ensure Uniformity and Consistency in the Determination of Penalties

A violation of a “binary” type requirement must be a “Severe” VSL.

Do not use ambiguous terms such as “minor” and “significant” to describe noncompliant performance.

### Guideline (3) – Violation Severity Level Assignment Should Be Consistent with the Corresponding Requirement

VSLs should not expand on what is required in the requirement.

**Guideline (4) – Violation Severity Level Assignment Should Be Based on A Single Violation, Not on A Cumulative Number of Violations**

Unless otherwise stated in the requirement, each instance of non-compliance with a requirement is a separate violation. Section 4 of the Sanction Guidelines states that assessing penalties on a per violation per day basis is the “default” for penalty calculations.

- **Requirement R1: No changes made to the VRF or VSL.**
- **Requirement R2: No changes made to the VRF or VSL.**
- **Requirement R3: No changes made to the VRF or VSL.**
- **Requirement R4: No changes made to the VRF or VSL.**

# Violation Risk Factor and Violation Severity Level Justifications

## Project 2016-02 – Modifications to CIP Standards

This document provides the standard drafting team's (SDT's) justification for assignment of the violation risk factor (VRF) and violation severity levels (VSLs) ~~for Requirements R1 and R2~~ in proposed NERC Reliability Standard CIP-003-8 — Cyber Security — Security Management Controls. These elements support the determination of an initial value range for the Base Penalty Amount regarding violations of requirements in FERC-approved Reliability Standards, as defined in the Electric Reliability Organizations (ERO) Sanction Guidelines. The SDT applied the following NERC criteria and FERC Guidelines when developing the VRFs and VSLs for the requirements.

### **NERC Criteria for Violation Risk Factors**

#### **High Risk Requirement**

A requirement that, if violated, could directly cause or contribute to Bulk Electric System instability, separation, or a cascading sequence of failures, or could place the Bulk Electric System at an unacceptable risk of instability, separation, or cascading failures; or, a requirement in a planning time frame that, if violated, could, under emergency, abnormal, or restorative conditions anticipated by the preparations, directly cause or contribute to Bulk Electric System instability, separation, or a cascading sequence of failures, or could place the Bulk Electric System at an unacceptable risk of instability, separation, or cascading failures, or could hinder restoration to a normal condition.

#### **Medium Risk Requirement**

A requirement that, if violated, could directly affect the electrical state or the capability of the Bulk Electric System, or the ability to effectively monitor and control the Bulk Electric System. However, violation of a medium risk requirement is unlikely to lead to Bulk Electric System instability, separation, or cascading failures; or, a requirement in a planning time frame that, if violated, could, under emergency, abnormal, or restorative conditions anticipated by the preparations, directly and adversely affect the electrical state or capability of the Bulk Electric System, or the ability to effectively monitor, control, or restore the Bulk Electric System. However, violation of a medium risk requirement is unlikely, under emergency, abnormal, or restoration conditions anticipated by the preparations, to lead to Bulk Electric System instability, separation, or cascading failures, nor to hinder restoration to a normal condition.

### Lower Risk Requirement

A requirement that is administrative in nature and a requirement that, if violated, would not be expected to adversely affect the electrical state or capability of the Bulk Electric System, or the ability to effectively monitor and control the Bulk Electric System; or, a requirement that is administrative in nature and a requirement in a planning time frame that, if violated, would not, under the emergency, abnormal, or restorative conditions anticipated by the preparations, be expected to adversely affect the electrical state or capability of the Bulk Electric System, or the ability to effectively monitor, control, or restore the Bulk Electric System.

## FERC Guidelines for Violation Risk Factors

### Guideline (1) – Consistency with the Conclusions of the Final Blackout Report

FERC seeks to ensure that VRFs assigned to Requirements of Reliability Standards in these identified areas appropriately reflect their historical critical impact on the reliability of the Bulk-Power System. In the VSL Order, FERC listed critical areas (from the Final Blackout Report) where violations could severely affect the reliability of the Bulk-Power System:

- Emergency operations
- Vegetation management
- Operator personnel training
- Protection systems and their coordination
- Operating tools and backup facilities
- Reactive power and voltage control
- System modeling and data exchange
- Communication protocol and facilities
- Requirements to determine equipment ratings
- Synchronized data recorders
- Clearer criteria for operationally critical facilities
- Appropriate use of transmission loading relief.



**Guideline (2) – Consistency within a Reliability Standard**

FERC expects a rational connection between the sub-Requirement VRF assignments and the main Requirement VRF assignment.

**Guideline (3) – Consistency among Reliability Standards**

FERC expects the assignment of VRFs corresponding to Requirements that address similar reliability goals in different Reliability Standards would be treated comparably.

**Guideline (4) – Consistency with NERC’s Definition of the Violation Risk Factor Level**

Guideline (4) was developed to evaluate whether the assignment of a particular VRF level conforms to NERC’s definition of that risk level.

**Guideline (5) – Treatment of Requirements that Co-mingle More Than One Obligation**

Where a single Requirement co-mingles a higher risk reliability objective and a lesser risk reliability objective, the VRF assignment for such Requirements must not be watered down to reflect the lower risk level associated with the less important objective of the Reliability Standard.

**NERC Criteria for Violation Severity Levels**

VSLs define the degree to which compliance with a requirement was not achieved. Each requirement must have at least one VSL. While it is preferable to have four VSLs for each requirement, some requirements do not have multiple “degrees” of noncompliant performance and may have only one, two, or three VSLs.

VSLs should be based on NERC’s overarching criteria shown in the table below:

Lower VSL	Moderate VSL	High VSL	Severe VSL
The performance or product measured almost meets the full intent of the requirement.	The performance or product measured meets the majority of the intent of the requirement.	The performance or product measured does not meet the majority of the intent of the requirement, but does meet some of the intent.	The performance or product measured does not substantively meet the intent of the requirement.

**FERC Order of Violation Severity Levels**

The FERC VSL guidelines are presented below, followed by an analysis of whether the VSLs proposed for each requirement in the standard meet the FERC Guidelines for assessing VSLs:

**Guideline (1) – Violation Severity Level Assignments Should Not Have the Unintended Consequence of Lowering the Current Level of Compliance**

Compare the VSLs to any prior levels of non-compliance and avoid significant changes that may encourage a lower level of compliance than was required when levels of non-compliance were used.

**Guideline (2) – Violation Severity Level Assignments Should Ensure Uniformity and Consistency in the Determination of Penalties**

A violation of a “binary” type requirement must be a “Severe” VSL.  
Do not use ambiguous terms such as “minor” and “significant” to describe noncompliant performance.

**Guideline (3) – Violation Severity Level Assignment Should Be Consistent with the Corresponding Requirement**

VSLs should not expand on what is required in the requirement.

#### **Guideline (4) – Violation Severity Level Assignment Should Be Based on A Single Violation, Not on A Cumulative Number of Violations**

Unless otherwise stated in the requirement, each instance of non-compliance with a requirement is a separate violation. Section 4 of the Sanction Guidelines states that assessing penalties on a per violation per day basis is the “default” for penalty calculations.

- **Requirement R1: No changes made to the VRF or VSL.**
- **Requirement R2: No changes made to the VRF or VSL.**
- **Requirement R3: No changes made to the VRF or VSL.**
- **Requirement R4: No changes made to the VRF or VSL.**

# Standards Announcement

## Project 2016-02 Modifications to CIP Standards

Final Ballot Open through April 29, 2019

### [Now Available](#)

A 10-day final ballot for **CIP-003-8 – Cyber Security - Security Management Controls** is open through **8 p.m. Eastern, Monday, April 29, 2019.**

### Balloting

In the final ballot, votes are counted by exception. Votes from the previous ballot are automatically carried over in the final ballot. Only members of the applicable ballot pools can cast a vote. Ballot pool members who previously voted have the option to change their vote in the final ballot. Ballot pool members who did not cast a vote during the previous ballot can vote in the final ballot.

Members of the ballot pools associated with this project can log in and submit their vote [here](#). If you experience any difficulties using the Standards Balloting & Commenting System (SBS), contact [Wendy Muller](#).

- *If you are having difficulty accessing the SBS due to a forgotten password, incorrect credential error messages, or system lock-out, contact NERC IT support directly at <https://support.nerc.net/> (Monday – Friday, 8 a.m. - 5 p.m. Eastern).*
- *Passwords expire every **6 months** and must be reset.*
- *The SBS **is not** supported for use on mobile devices.*
- *Please be mindful of ballot and comment period closing dates. We ask to **allow at least 48 hours** for NERC support staff to assist with inquiries. Therefore, it is recommended that users try logging into their SBS accounts **prior to the last day** of a comment/ballot period.*

### Next Steps

The voting results will be posted and announced after the ballot closes. If approved, the standard will be submitted to the Board of Trustees for adoption and then filed with the appropriate regulatory authorities.

For information on the Standards Development Process, refer to the [Standard Processes Manual](#).

For more information or assistance, contact Standards Developer, [Jordan Mallory](#) (via email) or at (404) 446-2589.

North American Electric Reliability Corporation  
3353 Peachtree Rd, NE  
Suite 600, North Tower  
Atlanta, GA 30326  
404-446-2560 | [www.nerc.com](http://www.nerc.com)

## BALLOT RESULTS

**Ballot Name:** 2016-02 Modifications to CIP Standards CIP-003-8 Draft 1 FN 2 ST

**Voting Start Date:** 4/18/2019 11:10:58 AM

**Voting End Date:** 4/29/2019 8:00:00 PM

**Ballot Type:** ST

**Ballot Activity:** FN

**Ballot Series:** 2

**Total # Votes:** 271

**Total Ballot Pool:** 324

**Quorum:** 83.64

**Quorum Established Date:** 4/18/2019 11:33:51 AM

**Weighted Segment Value:** 91.44

Segment	Ballot Pool	Segment Weight	Affirmative Votes	Affirmative Fraction	Negative Votes w/ Comment	Negative Fraction w/ Comment	Negative Votes w/o Comment	Abstain	No Vote
Segment: 1	89	1	63	0.863	10	0.137	0	1	15
Segment: 2	6	0.2	2	0.2	0	0	0	2	2
Segment: 3	73	1	50	0.893	6	0.107	0	4	13
Segment: 4	20	1	14	0.933	1	0.067	0	1	4
Segment: 5	73	1	55	0.873	8	0.127	0	0	10

Segment	Ballot Pool	Segment Weight	Affirmative Votes	Affirmative Fraction	Negative Votes w/ Comment	Negative Fraction w/ Comment	Negative Votes w/o Comment	Abstain	No Vote
Segment: 6	52	1	39	0.907	4	0.093	0	1	8
Segment: 7	1	0	0	0	0	0	0	0	1
Segment: 8	2	0.2	2	0.2	0	0	0	0	0
Segment: 9	1	0.1	1	0.1	0	0	0	0	0
Segment: 10	7	0.7	7	0.7	0	0	0	0	0
Totals:	324	6.2	233	5.669	29	0.531	0	9	53

## BALLOT POOL MEMBERS

Show  entries

Search:

Segment	Organization	Voter	Designated Proxy	Ballot	NERC Memo
1	AEP - AEP Service Corporation	Dennis Sauriol		Affirmative	N/A

Segment	Organization	Voter	Designated Proxy	Ballot	NERC Memo
1	Allete - Minnesota Power, Inc.	Jamie Monette		None	N/A
1	Ameren - Ameren Services	Eric Scott		Affirmative	N/A
1	American Transmission Company, LLC	LaTroy Brumfield		Affirmative	N/A
1	APS - Arizona Public Service Co.	Michelle Amaranos		Affirmative	N/A
1	Arizona Electric Power Cooperative, Inc.	John Shaver		None	N/A
1	Arkansas Electric Cooperative Corporation	Jennifer Loiacano		Affirmative	N/A
1	Associated Electric Cooperative, Inc.	Ryan Ziegler		Affirmative	N/A
1	Avista - Avista Corporation	Mike Magruder		None	N/A
1	Balancing Authority of Northern California	Kevin Smith	Joe Tarantino	Affirmative	N/A
1	Basin Electric Power Cooperative	David Rudolph		Affirmative	N/A
1	BC Hydro and Power Authority	Adrian Andreoiu		Affirmative	N/A
1	Beaches Energy Services	Don Cuevas	Brandon McCormick	Affirmative	N/A
1	Berkshire Hathaway Energy - MidAmerican Energy Co.	Terry Harbour		Affirmative	N/A
1	Black Hills Corporation	Wes Wingen		Negative	N/A
1	Bonneville Power Administration	Kammy Rogers-Holliday		Affirmative	N/A
1	Brazos Electric Power Cooperative, Inc.	Tony Kroskey		None	N/A
1	CenterPoint Energy Houston Electric, LLC	Daniela Hammons		Affirmative	N/A

Segment	Organization	Voter	Designated Proxy	Ballot	NERC Memo
1	Central Electric Power Cooperative (Missouri)	Michael Bax		None	N/A
1	Central Hudson Gas & Electric Corp.	Frank Pace		Affirmative	N/A
1	City Utilities of Springfield, Missouri	Michael Buyce		Affirmative	N/A
1	Cleco Corporation	John Lindsey	Louis Guidry	None	N/A
1	CMS Energy - Consumers Energy Company	Donald Lynd		Negative	N/A
1	Con Ed - Consolidated Edison Co. of New York	Dermot Smyth		Affirmative	N/A
1	Dominion - Dominion Virginia Power	Larry Nash		Affirmative	N/A
1	Duke Energy	Laura Lee		Affirmative	N/A
1	Edison International - Southern California Edison Company	Steven Mavis		Affirmative	N/A
1	Entergy - Entergy Services, Inc.	Oliver Burke		Affirmative	N/A
1	Eversource Energy	Quintin Lee		Affirmative	N/A
1	Exelon	Chris Scanlon		Affirmative	N/A
1	FirstEnergy - FirstEnergy Corporation	Julie Severino		Affirmative	N/A
1	Gainesville Regional Utilities	David Owens	Brandon McCormick	Affirmative	N/A
1	Georgia Transmission Corporation	Greg Davis		Affirmative	N/A
1	Glencoe Light and Power Commission	Terry Volkmann		Affirmative	N/A
1	Great Plains Energy - Kansas City Power and Light Co.	James McBee	Douglas Webb	Affirmative	N/A



Segment	Organization	Voter	Designated Proxy	Ballot	NERC Memo
1	Great River Energy	Gordon Pietsch		Affirmative	N/A
1	Hydro-Quebec TransEnergie	Nicolas Turcotte		Affirmative	N/A
1	IDACORP - Idaho Power Company	Laura Nelson		Negative	N/A
1	Imperial Irrigation District	Jesus Sammy Alcaraz		None	N/A
1	International Transmission Company Holdings Corporation	Michael Moltane	Stephanie Burns	Negative	N/A
1	JEA	Ted Hobson		Affirmative	N/A
1	Lakeland Electric	Larry Watt		Negative	N/A
1	Lincoln Electric System	Danny Pudenz		Affirmative	N/A
1	Long Island Power Authority	Robert Ganley		None	N/A
1	Los Angeles Department of Water and Power	faranak sarbaz		Affirmative	N/A
1	Lower Colorado River Authority	Matthew Lewis		Affirmative	N/A
1	Manitoba Hydro	Mike Smith		Affirmative	N/A
1	MEAG Power	David Weekley	Scott Miller	Affirmative	N/A
1	Minnkota Power Cooperative Inc.	Theresa Allard	Andy Fuhrman	Negative	N/A
1	Muscatine Power and Water	Andy Kurriger		Affirmative	N/A
1	National Grid USA	Michael Jones		Affirmative	N/A
1	NB Power Corporation	Randy MacDonald		None	N/A
1	North Carolina Electric Power Division	Jamison Cawley		Affirmative	N/A

Segment	Organization	Voter	Designated Proxy	Ballot	NERC Memo
1	Network and Security Technologies	Nicholas Lauriat		Affirmative	N/A
1	New York Power Authority	Salvatore Spagnolo		Affirmative	N/A
1	NextEra Energy - Florida Power and Light Co.	Mike O'Neil		Affirmative	N/A
1	NiSource - Northern Indiana Public Service Co.	Steve Toosevich		Affirmative	N/A
1	OGE Energy - Oklahoma Gas and Electric Co.	Terri Pyle		Negative	N/A
1	Omaha Public Power District	Doug Peterchuck		Affirmative	N/A
1	Oncor Electric Delivery	Lee Maurer	Tho Tran	Affirmative	N/A
1	OTP - Otter Tail Power Company	Charles Wicklund		Affirmative	N/A
1	Peak Reliability	Scott Downey		Affirmative	N/A
1	PNM Resources - Public Service Company of New Mexico	Laurie Williams		Affirmative	N/A
1	Portland General Electric Co.	Nathaniel Clague		None	N/A
1	PPL Electric Utilities Corporation	Brenda Truhe		Affirmative	N/A
1	PSEG - Public Service Electric and Gas Co.	Joseph Smith		Affirmative	N/A
1	Public Utility District No. 1 of Chelan County	Jeff Kimbell		Affirmative	N/A
1	Public Utility District No. 1 of Pend Oreille County	Kevin Conway		None	N/A
1	Public Utility District No. 1 of Snohomish County	Long Duong		Affirmative	N/A
1	Puget Sound Energy, Inc.	Theresa Rakowsky		Affirmative	N/A
1	Sacramento Municipal Utility District	Arthur Starkovich	Joe Tarantino	Affirmative	N/A

Segment	Organization	Voter	Designated Proxy	Ballot	NERC Memo
1	Santee Cooper	Chris Wagner		Negative	N/A
1	SaskPower	Wayne Guttormson		Affirmative	N/A
1	SCANA - South Carolina Electric and Gas Co.	Tom Hanzlik		Affirmative	N/A
1	Seattle City Light	Pawel Krupa		None	N/A
1	Seminole Electric Cooperative, Inc.	Mark Churilla		Abstain	N/A
1	Sempra - San Diego Gas and Electric	Mo Derbas		None	N/A
1	Sho-Me Power Electric Cooperative	Peter Dawson		Affirmative	N/A
1	Southern Company - Southern Company Services, Inc.	Katherine Prewitt		Affirmative	N/A
1	Sunflower Electric Power Corporation	Paul Mehlhaff		Negative	N/A
1	Tacoma Public Utilities (Tacoma, WA)	John Merrell		Affirmative	N/A
1	Tallahassee Electric (City of Tallahassee, FL)	Scott Langston		None	N/A
1	Tennessee Valley Authority	Gabe Kurtz		Affirmative	N/A
1	Tri-State G and T Association, Inc.	Tracy Sliman		Affirmative	N/A
1	U.S. Bureau of Reclamation	Richard Jackson		Negative	N/A
1	Unisource - Tucson Electric Power Co.	John Tolo		None	N/A
1	Westar Energy	Allen Klassen	Douglas Webb	Affirmative	N/A
1	Western Area Power Administration	sean erickson		Affirmative	N/A
1	Xcel Energy, Inc.	Dean Schiro		Affirmative	N/A

<b>Segment</b>	<b>Organization</b>	<b>Voter</b>	<b>Designated Proxy</b>	<b>Ballot</b>	<b>NERC Memo</b>
2	Electric Reliability Council of Texas, Inc.	Brandon Gleason		Abstain	N/A
2	Independent Electricity System Operator	Leonard Kula		Affirmative	N/A
2	Midcontinent ISO, Inc.	David Zwergel		None	N/A
2	New York Independent System Operator	Gregory Campoli		None	N/A
2	PJM Interconnection, L.L.C.	Mark Holman		Abstain	N/A
2	Southwest Power Pool, Inc. (RTO)	Charles Yeung		Affirmative	N/A
3	AEP	Leanna Lamatrice		Affirmative	N/A
3	Ameren - Ameren Services	David Jendras		Affirmative	N/A
3	APS - Arizona Public Service Co.	Vivian Vo		Affirmative	N/A
3	Associated Electric Cooperative, Inc.	Todd Bennett		Affirmative	N/A
3	Austin Energy	W. Dwayne Preston		None	N/A
3	Avista - Avista Corporation	Scott Kinney		Affirmative	N/A
3	Basin Electric Power Cooperative	Jeremy Voll		Affirmative	N/A
3	Beaches Energy Services	Steven Lancaster	Brandon McCormick	Affirmative	N/A
3	Berkshire Hathaway Energy - MidAmerican Energy Co.	Darnez Gresham		Affirmative	N/A
3	Black Hills Corporation	Eric Egge		Negative	N/A
3	Bonneville Power Administration	Rebecca Berdahl		Affirmative	N/A

Segment	Organization	Voter	Designated Proxy	Ballot	NERC Memo
3	City of Farmington	Linda Jacobson-Quinn		Abstain	N/A
3	City of Vero Beach	Ginny Beigel	Brandon McCormick	Affirmative	N/A
3	City Utilities of Springfield, Missouri	Scott Williams		Affirmative	N/A
3	Clark Public Utilities	Jack Stamper		None	N/A
3	Cleco Corporation	Maurice Paulk	Louis Guidry	None	N/A
3	CMS Energy - Consumers Energy Company	Karl Blaszkowski		Negative	N/A
3	Con Ed - Consolidated Edison Co. of New York	Peter Yost		Affirmative	N/A
3	Cowlitz County PUD	Russell Noble		Affirmative	N/A
3	Dominion - Dominion Resources, Inc.	Connie Lowe		Affirmative	N/A
3	DTE Energy - Detroit Edison Company	Karie Barczak		Affirmative	N/A
3	Duke Energy	Lee Schuster		Affirmative	N/A
3	Edison International - Southern California Edison Company	Romel Aquino		Affirmative	N/A
3	Empire District Electric Co.	Kalem Long		None	N/A
3	Eversource Energy	Sharon Flannery		Affirmative	N/A
3	Exelon	John Bee		Affirmative	N/A
3	FirstEnergy - FirstEnergy Corporation	Aaron Ghodooshim		Affirmative	N/A
3	Gainesville Regional Utilities	Ken Simmons	Brandon McCormick	Affirmative	N/A

Segment	Organization	Voter	Designated Proxy	Ballot	NERC Memo
3	Georgia System Operations Corporation	Scott McGough		None	N/A
3	Great Plains Energy - Kansas City Power and Light Co.	John Carlson	Douglas Webb	Affirmative	N/A
3	Hydro One Networks, Inc.	Paul Malozewski	Oshani Pathirane	Affirmative	N/A
3	Imperial Irrigation District	Denise Sanchez		None	N/A
3	Intermountain REA	Pam Feuerstein		Affirmative	N/A
3	JEA	Garry Baker		None	N/A
3	KAMO Electric Cooperative	Tony Gott		None	N/A
3	Lakeland Electric	Patricia Boody		Negative	N/A
3	M and A Electric Power Cooperative	Stephen Pogue		Affirmative	N/A
3	Manitoba Hydro	Karim Abdel-Hadi		Affirmative	N/A
3	MEAG Power	Roger Brand	Scott Miller	Affirmative	N/A
3	Muscatine Power and Water	Seth Shoemaker		Affirmative	N/A
3	National Grid USA	Brian Shanahan		Affirmative	N/A
3	Nebraska Public Power District	Tony Eddleman		Affirmative	N/A
3	New York Power Authority	David Rivera		Affirmative	N/A
3	NiSource - Northern Indiana Public Service Co.	Dmitriy Bazylyuk		Affirmative	N/A
3	North Carolina Electric Membership Corporation	doug white	Kagen DelRio	Affirmative	N/A
3	Northeast Missouri Electric Power Cooperative	Skyler Wiegmann		None	N/A

<b>Segment</b>	<b>Organization</b>	<b>Voter</b>	<b>Designated Proxy</b>	<b>Ballot</b>	<b>NERC Memo</b>
3	Ocala Utility Services	Neville Bowen	Brandon McCormick	Affirmative	N/A
3	OGE Energy - Oklahoma Gas and Electric Co.	Donald Hargrove		Negative	N/A
3	Omaha Public Power District	Aaron Smith		Negative	N/A
3	OTP - Otter Tail Power Company	Wendi Olson		Affirmative	N/A
3	Owensboro Municipal Utilities	Thomas Lyons		Affirmative	N/A
3	Platte River Power Authority	Jeff Landis		Abstain	N/A
3	Portland General Electric Co.	Dan Zollner		Abstain	N/A
3	PPL - Louisville Gas and Electric Co.	Joseph Bencomo		Affirmative	N/A
3	Public Utility District No. 1 of Chelan County	Joyce Gundry		Affirmative	N/A
3	Public Utility District No. 1 of Pend Oreille County	Amber Orr		Affirmative	N/A
3	Rutherford EMC	Tom Haire		None	N/A
3	Sacramento Municipal Utility District	Nicole Looney	Joe Tarantino	Affirmative	N/A
3	Santee Cooper	James Poston		Negative	N/A
3	SCANA - South Carolina Electric and Gas Co.	Scott Parker		Affirmative	N/A
3	Seminole Electric Cooperative, Inc.	James Frauen		Abstain	N/A
3	Sempra - San Diego Gas and Electric	Bridget Silvia	Jeff Johnson	Affirmative	N/A
3	Sho-Me Power Electric Cooperative	Jeff Neas		Affirmative	N/A
3	Snohomish County PUD No. 1	Holly Chaney		Affirmative	N/A

<b>Segment</b>	<b>Organization</b>	<b>Voter</b>	<b>Designated Proxy</b>	<b>Ballot</b>	<b>NERC Memo</b>
3	Southern Company - Alabama Power Company	Joel Dembowski		Affirmative	N/A
3	Southern Indiana Gas and Electric Co.	Ryan Abshier		None	N/A
3	Tacoma Public Utilities (Tacoma, WA)	Marc Donaldson		Affirmative	N/A
3	TECO - Tampa Electric Co.	Ronald Donahey		None	N/A
3	Tennessee Valley Authority	Ian Grant		Affirmative	N/A
3	Tri-State G and T Association, Inc.	Janelle Marriott Gill		None	N/A
3	WEC Energy Group, Inc.	Thomas Breene		Affirmative	N/A
3	Westar Energy	Bryan Taggart	Douglas Webb	Affirmative	N/A
3	Xcel Energy, Inc.	Michael Ibold		Affirmative	N/A
4	Alliant Energy Corporation Services, Inc.	Larry Heckert		Affirmative	N/A
4	American Public Power Association	Jack Cashin		None	N/A
4	Arkansas Electric Cooperative Corporation	Alice Wright		Affirmative	N/A
4	Austin Energy	Esther Weekes		None	N/A
4	City of Poplar Bluff	Neal Williams		None	N/A
4	City Utilities of Springfield, Missouri	John Allen		Affirmative	N/A
4	CMS Energy - Consumers Energy Company	Theresa Martinez		Negative	N/A
4	FirstEnergy - FirstEnergy Corporation	Aubrey Short		Affirmative	N/A
4	Florida Municipal Power Agency	Carol Chinn	Brandon McCormick	Affirmative	N/A



Segment	Organization	Voter	Designated Proxy	Ballot	NERC Memo
4	Georgia System Operations Corporation	Andrea Barclay		Affirmative	N/A
4	Illinois Municipal Electric Agency	Mary Ann Todd		Abstain	N/A
4	MGE Energy - Madison Gas and Electric Co.	Joseph DePoorter		Affirmative	N/A
4	National Rural Electric Cooperative Association	Barry Lawson		Affirmative	N/A
4	North Carolina Electric Membership Corporation	John Lemire	Kagen DelRio	Affirmative	N/A
4	Public Utility District No. 1 of Snohomish County	John Martinsen		Affirmative	N/A
4	Sacramento Municipal Utility District	Beth Tincher	Joe Tarantino	Affirmative	N/A
4	Seattle City Light	Hao Li		Affirmative	N/A
4	South Mississippi Electric Power Association	Steve McElhaney		None	N/A
4	Tacoma Public Utilities (Tacoma, WA)	Hien Ho		Affirmative	N/A
4	WEC Energy Group, Inc.	Matthew Beilfuss		Affirmative	N/A
5	AEP	Thomas Foltz		Affirmative	N/A
5	Ameren - Ameren Missouri	Sam Dwyer		Affirmative	N/A
5	APS - Arizona Public Service Co.	Kelsi Rigby		Affirmative	N/A
5	Arkansas Electric Cooperative Corporation	Moses Harris		Affirmative	N/A
5	Associated Electric Cooperative, Inc.	Brad Haralson		Affirmative	N/A
5	Austin Energy	Shirley Mathew		None	N/A
5	Avista - Avista Corporation	Glen Farmer		None	N/A
5	Basin Electric Power Cooperative	Mike Kraft		Affirmative	N/A

Segment	Organization	Voter	Designated Proxy	Ballot	NERC Memo
5	BC Hydro and Power Authority	Helen Hamilton Harding		Affirmative	N/A
5	Berkshire Hathaway - NV Energy	Kevin Salsbury		Affirmative	N/A
5	Black Hills Corporation	George Tatar		Negative	N/A
5	Boise-Kuna Irrigation District - Lucky Peak Power Plant Project	Mike Kukla		Affirmative	N/A
5	Bonneville Power Administration	Scott Winner		Affirmative	N/A
5	Brazos Electric Power Cooperative, Inc.	Shari Heino		Negative	N/A
5	Choctaw Generation Limited Partnership, LLLP	Rob Watson		Affirmative	N/A
5	City Water, Light and Power of Springfield, IL	Steve Rose		Affirmative	N/A
5	Cleco Corporation	Stephanie Huffman	Louis Guidry	None	N/A
5	CMS Energy - Consumers Energy Company	David Greyerbiehl		Negative	N/A
5	Con Ed - Consolidated Edison Co. of New York	William Winters	Daniel Valle	Affirmative	N/A
5	Cowlitz County PUD	Deanna Carlson		Affirmative	N/A
5	Dominion - Dominion Resources, Inc.	Lou Oberski		Affirmative	N/A
5	DTE Energy - Detroit Edison Company	Jeffrey DePriest		None	N/A
5	Duke Energy	Dale Goodwine		Affirmative	N/A
5	Entergy	Jamie Prater		Affirmative	N/A
5	Exelon	Ruth Miller		Affirmative	N/A
5	First Energy Intermediate Holdings	Robert Loy		Affirmative	N/A

Segment	Organization	Voter	Designated Proxy	Ballot	NERC Memo
5	Florida Municipal Power Agency	Chris Gowder	Brandon McCormick	Affirmative	N/A
5	Great Plains Energy - Kansas City Power and Light Co.	Harold Wyble	Douglas Webb	Affirmative	N/A
5	Great River Energy	Preston Walsh		Affirmative	N/A
5	Hydro-Quebec Production	Junji Yamaguchi		None	N/A
5	JEA	John Babik		Affirmative	N/A
5	Lakeland Electric	Jim Howard		Negative	N/A
5	Lincoln Electric System	Kayleigh Wilkerson		Affirmative	N/A
5	Los Angeles Department of Water and Power	Glenn Barry		Affirmative	N/A
5	Lower Colorado River Authority	Teresa Cantwell		Affirmative	N/A
5	Manitoba Hydro	Yuguang Xiao	Helen Zhao	Affirmative	N/A
5	Massachusetts Municipal Wholesale Electric Company	David Gordon		Affirmative	N/A
5	MEAG Power	Steven Grego	Scott Miller	Affirmative	N/A
5	Muscatine Power and Water	Neal Nelson		Affirmative	N/A
5	National Grid USA	Elizabeth Spivak		Affirmative	N/A
5	NaturEner USA, LLC	Eric Smith		Affirmative	N/A
5	NB Power Corporation	Laura McLeod		None	N/A
5	Nebraska Public Power District	Don Schmit		Affirmative	N/A

Segment	Organization	Voter	Designated Proxy	Ballot	NERC Memo
5	New York Power Authority	Shivaz Chopra		Affirmative	N/A
5	NiSource - Northern Indiana Public Service Co.	Kathryn Tackett		Affirmative	N/A
5	North Carolina Electric Membership Corporation	Robert Beadle	Kagen DelRio	Affirmative	N/A
5	NRG - NRG Energy, Inc.	Patricia Lynch		Affirmative	N/A
5	OGE Energy - Oklahoma Gas and Electric Co.	Patrick Wells		Negative	N/A
5	Oglethorpe Power Corporation	Donna Johnson		Affirmative	N/A
5	Omaha Public Power District	Mahmood Safi		Affirmative	N/A
5	Platte River Power Authority	Tyson Archie		Negative	N/A
5	Portland General Electric Co.	Ryan Olson		None	N/A
5	PPL - Louisville Gas and Electric Co.	JULIE HOSTRANDER		Affirmative	N/A
5	PSEG - PSEG Fossil LLC	Tim Kucey		Affirmative	N/A
5	Public Utility District No. 1 of Chelan County	Meaghan Connell		Affirmative	N/A
5	Public Utility District No. 1 of Snohomish County	Sam Nietfeld		Affirmative	N/A
5	Public Utility District No. 2 of Grant County, Washington	Alex Ybarra		Affirmative	N/A
5	Puget Sound Energy, Inc.	Eleanor Ewry		Affirmative	N/A
5	Sacramento Municipal Utility District	Susan Oto	Joe Tarantino	Affirmative	N/A
5	Santee Cooper	Tommy Curtis		Negative	N/A
5	SCANA - South Carolina Electric & Gas Co.	Alyssa Hubbard		Affirmative	N/A

<b>Segment</b>	<b>Organization</b>	<b>Voter</b>	<b>Designated Proxy</b>	<b>Ballot</b>	<b>NERC Memo</b>
5	Seattle City Light	Faz Kasraie		None	N/A
5	Sempra - San Diego Gas and Electric	Daniel Frank	Andrey Komissarov	Affirmative	N/A
5	Southern Company - Southern Company Generation	William D. Shultz		Affirmative	N/A
5	SunPower	Bradley Collard		None	N/A
5	Tacoma Public Utilities (Tacoma, WA)	Ozan Ferrin		Affirmative	N/A
5	Tennessee Valley Authority	M Lee Thomas		Affirmative	N/A
5	Tri-State G and T Association, Inc.	Richard Schlottmann		Affirmative	N/A
5	U.S. Bureau of Reclamation	Wendy Center		Negative	N/A
5	Vistra Energy	Dan Roethemeyer		None	N/A
5	WEC Energy Group, Inc.	Linda Horn		Affirmative	N/A
5	Westar Energy	Derek Brown	Douglas Webb	Affirmative	N/A
5	Xcel Energy, Inc.	Gerry Huitt		Affirmative	N/A
6	AEP - AEP Marketing	Yee Chou		Affirmative	N/A
6	Ameren - Ameren Services	Robert Quinlivan		Affirmative	N/A
6	APS - Arizona Public Service Co.	Chinedu Ochonogor		Affirmative	N/A
6	Arkansas Electric Cooperative Corporation	Bruce Walkup		Affirmative	N/A
6	Associated Electric Cooperative, Inc.	Brian Ackermann		Affirmative	N/A
6	Austin Energy	Andrew Gallo		None	N/A

Segment	Organization	Voter	Designated Proxy	Ballot	NERC Memo
6	Basin Electric Power Cooperative	Jerry Horner		Affirmative	N/A
6	Berkshire Hathaway - PacifiCorp	Sandra Shaffer		Affirmative	N/A
6	Black Hills Corporation	Eric Scherr		Negative	N/A
6	Bonneville Power Administration	Andrew Meyers		Affirmative	N/A
6	Cleco Corporation	Robert Hirschak	Louis Guidry	None	N/A
6	Con Ed - Consolidated Edison Co. of New York	Christopher Overberg		Affirmative	N/A
6	Dominion - Dominion Resources, Inc.	Sean Bodkin		Affirmative	N/A
6	Duke Energy	Greg Cecil		Affirmative	N/A
6	Edison International - Southern California Edison Company	Kenya Streeter		None	N/A
6	Entergy	Julie Hall		Affirmative	N/A
6	Exelon	Becky Webb		Affirmative	N/A
6	FirstEnergy - FirstEnergy Solutions	Ann Carey		Affirmative	N/A
6	Florida Municipal Power Agency	Richard Montgomery	Brandon McCormick	Affirmative	N/A
6	Florida Municipal Power Pool	Tom Reedy	Brandon McCormick	Affirmative	N/A
6	Great Plains Energy - Kansas City Power and Light Co.	Jennifer Flandermeyer	Douglas Webb	Affirmative	N/A
6	Great River Energy	Donna Stephenson	Michael Brytowski	Affirmative	N/A
6	Lincoln Electric System	Eric Ruskamp		Affirmative	N/A

Segment	Organization	Voter	Designated Proxy	Ballot	NERC Memo
6	Los Angeles Department of Water and Power	Anton Vu		Affirmative	N/A
6	Luminant - Luminant Energy	Kris Butler		None	N/A
6	Manitoba Hydro	Blair Mukanik		None	N/A
6	Muscatine Power and Water	Ryan Streck		Affirmative	N/A
6	New York Power Authority	Thomas Savin		Affirmative	N/A
6	NextEra Energy - Florida Power and Light Co.	Silvia Mitchell		Affirmative	N/A
6	NiSource - Northern Indiana Public Service Co.	Joe O'Brien		Affirmative	N/A
6	Northern California Power Agency	Dennis Sismaet		Negative	N/A
6	NRG - NRG Energy, Inc.	Martin Sidor		Affirmative	N/A
6	OGE Energy - Oklahoma Gas and Electric Co.	Sing Tay		Negative	N/A
6	Platte River Power Authority	Sabrina Martz		None	N/A
6	Portland General Electric Co.	Daniel Mason		None	N/A
6	PPL - Louisville Gas and Electric Co.	Linn Oelker		Affirmative	N/A
6	PSEG - PSEG Energy Resources and Trade LLC	Luiggi Beretta		Affirmative	N/A
6	Public Utility District No. 1 of Chelan County	Davis Jelusich		Affirmative	N/A
6	Public Utility District No. 2 of Grant County, Washington	LeRoy Patterson		Affirmative	N/A
6	Sacramento Municipal Utility District	Jamie Cutlip	Joe Tarantino	Affirmative	N/A
6	Santee Cooper	Michael Brown		Negative	N/A

Segment	Organization	Voter	Designated Proxy	Ballot	NERC Memo
6	SCANA - South Carolina Electric and Gas Co.	John Folsom		Affirmative	N/A
6	Seattle City Light	Charles Freeman		Affirmative	N/A
6	Seminole Electric Cooperative, Inc.	Trudy Novak		Abstain	N/A
6	Snohomish County PUD No. 1	Franklin Lu		Affirmative	N/A
6	Southern Company - Southern Company Generation and Energy Marketing	Jennifer Sykes		Affirmative	N/A
6	Southern Indiana Gas and Electric Co.	Brad Lisembee		None	N/A
6	Tacoma Public Utilities (Tacoma, WA)	Rick Applegate		Affirmative	N/A
6	Tennessee Valley Authority	Marjorie Parsons		Affirmative	N/A
6	WEC Energy Group, Inc.	David Hathaway		Affirmative	N/A
6	Westar Energy	Grant Wilkerson	Douglas Webb	Affirmative	N/A
6	Xcel Energy, Inc.	Carrie Dixon		Affirmative	N/A
7	Luminant Mining Company LLC	Amanda Frazier		None	N/A
8	David Kiguel	David Kiguel		Affirmative	N/A
8	Roger Zaklukiewicz	Roger Zaklukiewicz		Affirmative	N/A
9	Commonwealth of Massachusetts Department of Public Utilities	Donald Nelson		Affirmative	N/A
10	Florida Reliability Coordinating Council	Peter Heidrich		Affirmative	N/A
10	Midwest Reliability Organization	Russel Mountjoy		Affirmative	N/A
10	New York State Reliability Council	ALAN ADAMSON		Affirmative	N/A



Segment	Organization	Voter	Designated Proxy	Ballot	NERC Memo
10	Northeast Power Coordinating Council	Guy V. Zito		Affirmative	N/A
10	ReliabilityFirst	Anthony Jablonski		Affirmative	N/A
10	SERC Reliability Corporation	Drew Slabaugh		Affirmative	N/A
10	Texas Reliability Entity, Inc.	Rachel Coyne		Affirmative	N/A

Showing 1 to 324 of 324 entries

Previous

1

Next

**Exhibit F**  
**Standard Drafting Team Roster**

## Standard Drafting Team Roster

### Project 2016-02 Modifications to CIP Standards

	Name	Entity
<b>Co-Chair</b>	Jay Cribb	Southern Company
<b>Co-Chair</b>	Matthew Hyatt	Tennessee Valley Authority
<b>Members</b>	Steven Brain	Dominion Energy
	Jake Brown	ERCOT
	Gerald Freese	NIPSCO
	Scott Klauminzer	Tacoma Public Utilities, Tacoma Power
	Forrest Krigbaum	Bonneville Power Administration
	Heather Morgan	EDP Renewables
	Mark Riley	Calpine
<b>PMOS Liaisons</b>	Ken Lanehome	Bonneville Power Administration
	Kirk Rosener	CPS Energy
<b>NERC Staff</b>	Jordan Mallory – Standards Developer	North American Electric Reliability Corporation
	Shamai Elstein – Senior Counsel	North American Electric Reliability Corporation
	Marisa Hecht – Counsel	North American Electric Reliability Corporation