

Exhibit A

**Proposed Reliability Standard PRC-024-3
Frequency and Voltage Protection Settings for Generating Resources**

Exhibit A

**Proposed Reliability Standard PRC-024-3
Frequency and Voltage Protection Settings for Generating Resources**

Clean

A. Introduction

1. **Title:** **Frequency and Voltage Protection Settings** for Generating Resources
2. **Number:** PRC-024-3
3. **Purpose:** To set protection such that generating resource(s) remain connected during defined frequency and voltage excursions in support of the Bulk Electric System (BES).
4. **Applicability:**
 - 4.1. **Functional Entities:**
 - 4.1.1 Generator Owners that apply protection listed in Section 4.2.1.
 - 4.1.2 Transmission Owners (in the Quebec Interconnection only) that own a BES generator step-up (GSU) transformer or main power transformer (MPT)¹ and apply protection listed in Section 4.2.1.
 - 4.1.3 Planning Coordinators (in the Quebec Interconnection only)
 - 4.2. **Facilities²:**
 - 4.2.1 Frequency, voltage, and volts per hertz protection (whether provided by relaying or functions within associated control systems) that respond to electrical signals and: (i) directly trip the generating resource(s); or (ii) provide signals to the generating resource(s) to either trip or cease injecting current; and are applied to the following:
 - 4.2.1.1 BES generating resource(s).
 - 4.2.1.2 BES GSU transformer(s).
 - 4.2.1.3 High side of the generator-connected unit auxiliary transformer³ (UAT) installed on BES generating resource(s).
 - 4.2.1.4 Individual dispersed power producing resource(s) identified in the BES Definition, Inclusion I4.
 - 4.2.1.5 Elements that are designed primarily for the delivery of capacity from the individual dispersed power producing resources identified in the BES Definition, Inclusion I4, to the point where those resources aggregate to greater than 75 MVA.

¹ For the purpose of this standard, the MPT is the power transformer that steps up voltage from the collection system voltage to the nominal transmission/interconnecting system voltage for dispersed power producing resources.

² It is not required to install or activate the protections described in Facilities Section 4.2.

³ These transformers are variably referred to as station power UAT, or station service transformer(s) used to provide overall auxiliary power to the generating resource(s). This UAT is the transformer connected on the generator bus between the low side of the GSU and the generator terminal.

4.2.1.6 MPT⁴ of resource(s) identified in the BES Definition, Inclusion I4.

4.2.2 Exemptions: Protection on all auxiliary equipment within the generating Facility.

5. Effective Date: See the Implementation Plan for PRC-024-3.

⁴ For the purpose of this standard, the MPT is the power transformer that steps up voltage from the collection system voltage to the nominal transmission/interconnecting system voltage for dispersed power producing resources

B. Requirements and Measures

- R1.** Each Generator Owner shall set its applicable frequency protection⁵ in accordance with PRC-024 Attachment 1 such that the applicable protection does not cause the generating resource to trip or cease injecting current within the “no trip zone” during a frequency excursion with the following exceptions: *[Violation Risk Factor: Medium]* *[Time Horizon: Long-term Planning]*
- Applicable frequency protection may be set to trip or cease injecting current within a portion of the “no trip zone” for documented and communicated regulatory or equipment limitations in accordance with Requirement R3.
- M1.** Each Generator Owner shall have evidence that the applicable frequency protection has been set in accordance with Requirement R1, such as dated setting sheets, calibration sheets, calculations, or other documentation.
- R2.** Each Generator Owner shall set its applicable voltage protection⁵ in accordance with PRC-024 Attachment 2, such that the applicable protection does not cause the generating resource to trip or cease injecting current within the “no trip zone” during a voltage excursion at the high side of the GSU or MPT, subject to the following exceptions: *[Violation Risk Factor: Medium]* *[Time Horizon: Long-term Planning]*
- If the Transmission Planner allows less stringent voltage protection settings than those required to meet PRC-024 Attachment 2, then the Generator Owner may set its protection within the voltage recovery characteristics of a location-specific Transmission Planner’s study.
 - Applicable voltage protection may be set to trip or cease injecting current during a voltage excursion within a portion of the “no trip zone” for documented and communicated regulatory or equipment limitations in accordance with Requirement R3.
- M2.** Each Generator Owner shall have evidence that applicable voltage protection has been set in accordance with Requirement R2, such as dated setting sheets, voltage-time boundaries, calibration sheets, coordination plots, dynamic simulation studies, calculations, or other documentation.

⁵ Frequency, voltage, and volts per hertz protection (whether provided by relaying or functions within associated control systems) that respond to electrical signals and: (i) directly trip the generating resource(s); or (ii) provide signals to the generating resource(s) to either trip or cease injecting current.

- R3.** Each Generator Owner shall document each known regulatory or equipment limitation⁶ that prevents an applicable generating resource(s) with frequency or voltage protection from meeting the protection setting criteria in Requirements R1 or R2, including (but not limited to) study results, experience from an actual event, or manufacturer’s advice.
[Violation Risk Factor: Lower] [Time Horizon: Long-term Planning]
- 3.1.** The Generator Owner shall communicate the documented regulatory or equipment limitation, or the removal of a previously documented regulatory or equipment limitation, to its Planning Coordinator and Transmission Planner within 30 calendar days of any of the following:
- Identification of a regulatory or equipment limitation.
 - Repair of the equipment causing the limitation that removes the limitation.
 - Replacement of the equipment causing the limitation with equipment that removes the limitation.
 - Creation or adjustment of an equipment limitation caused by consumption of the cumulative turbine life-time frequency excursion allowance.
- M3.** Each Generator Owner shall have evidence that it has documented and communicated any known regulatory or equipment limitations that resulted in an exception to Requirements R1 or R2 in accordance with Requirement R3, such as a dated email or letter that contains such documentation as study results, experience from an actual event, or manufacturer’s advice.
- R4.** Each Generator Owner shall provide its applicable protection settings associated with Requirements R1 and R2 to the Planning Coordinator or Transmission Planner that models the associated generating resource(s) within 60 calendar days of receipt of a written request for the data and within 60 calendar days of any change to those previously requested settings unless directed by the requesting Planning Coordinator or Transmission Planner that the reporting of protection setting changes is not required.
[Violation Risk Factor: Lower] [Time Horizon: Operations Planning]
- M4.** Each Generator Owner shall have evidence that it communicated applicable protection settings in accordance with Requirement R4, such as dated e-mails, correspondence or other evidence and copies of any requests it has received for that information.

⁶ Excludes limitations caused by the setting capability of the frequency, voltage, and volts per hertz protective relays for the generating resource(s). This does not exclude limitations originating in the equipment protected by the relay. This also does not exclude limitations of frequency, voltage, and volts per hertz protection embedded in control systems.

C. Compliance

1. Compliance Monitoring Process

1.1. Compliance Enforcement Authority: “Compliance Enforcement Authority” means NERC or the Regional Entity, or any entity as otherwise designated by an Applicable Governmental Authority, in their respective roles of monitoring and/or enforcing compliance with mandatory and enforceable Reliability Standards in their respective jurisdictions.

1.2. Evidence Retention: The following evidence retention period(s) identify the period of time an entity is required to retain specific evidence to demonstrate compliance. For instances where the evidence retention period specified below is shorter than the time since the last audit, the Compliance Enforcement Authority may ask an entity to provide other evidence to show that it was compliant for the full-time period since the last audit.

The applicable entity shall keep data or evidence to show compliance as identified below unless directed by its Compliance Enforcement Authority to retain specific evidence for a longer period of time as part of an investigation.

- The Generator Owner shall keep data or evidence Requirement R1 through R4; for 3 years or until the next audit, whichever is longer.
- If a Generator Owner is found non-compliant, the Generator Owner or Transmission Owner shall keep information related to the non-compliance until mitigation is complete and approved for the time period specified above, whichever is longer.

1.3. Compliance Monitoring and Assessment Program: As defined in the NERC Rules of Procedure, “Compliance Monitoring and Enforcement Program” refers to the identification of the processes that will be used to evaluate data or information for the purpose of assessing performance or outcomes with the associated Reliability Standard.

Violation Severity Levels

R #	Violation Severity Levels			
	Lower VSL	Moderate VSL	High VSL	Severe VSL
R1.	N/A	N/A	N/A	The Generator Owner failed to set its applicable frequency protection so that it does not trip or cease injecting current according to Requirement R1.
R2.	N/A	N/A	N/A	The Generator Owner failed to set its applicable voltage protection so that it does not trip or cease injecting current according to Requirement R2.
R3.	The Generator Owner documented the known non-protection system equipment limitation that prevented it from meeting the criteria in Requirement R1 or R2 and communicated the documented limitation to its Planning Coordinator and Transmission Planner more than 30 calendar days but less than or equal to 60 calendar	The Generator Owner documented the known non-protection system equipment limitation that prevented it from meeting the criteria in Requirement R1 or R2 and communicated the documented limitation to its Planning Coordinator and Transmission Planner more than 60 calendar days but less than or equal	The Generator Owner documented the known non-protection system equipment limitation that prevented it from meeting the criteria in Requirement R1 or R2 and communicated the documented limitation to its Planning Coordinator and Transmission Planner more than 90 calendar	The Generator Owner failed to document any known non-protection system equipment limitation that prevented it from meeting the criteria in Requirement R1 or R2. OR The Generator Owner failed to communicate the

R #	Violation Severity Levels			
	Lower VSL	Moderate VSL	High VSL	Severe VSL
	days of identifying the limitation.	to 90 calendar days of identifying the limitation.	days but less than or equal to 120 calendar days of identifying the limitation.	documented limitation to its Planning Coordinator and Transmission Planner within 120 calendar days of identifying the limitation.
R4.	<p>The Generator Owner provided its protection settings more than 60 calendar days but less than or equal to 90 calendar days of any change to those settings.</p> <p>OR</p> <p>The Generator Owner provided protection settings more than 60 calendar days but less than or equal to 90 calendar days of a written request.</p>	<p>The Generator Owner provided its protection settings more than 90 calendar days but less than or equal to 120 calendar days of any change to those settings.</p> <p>OR</p> <p>The Generator Owner provided protection settings more than 90 calendar days but less than or equal to 120 calendar days of a written request.</p>	<p>The Generator Owner provided its protection settings more than 120 calendar days but less than or equal to 150 calendar days of any change to those settings.</p> <p>OR</p> <p>The Generator Owner provided protection settings more than 120 calendar days but less than or equal to 150 calendar days of a written request.</p>	<p>The Generator Owner failed to provide its protection settings within 150 calendar days of any change to those settings.</p> <p>OR</p> <p>The Generator Owner failed to provide protection settings within 150 calendar days of a written request.</p>

D. Regional Variances

D.A. Variance for the Quebec Interconnection

This Variance extends the applicability of Requirements R1, R3, and R4 to Transmission Owners in the Quebec Interconnection that own a BES GSU or MPT and apply protection listed in Section 4.2.1, Facilities. This Variance also replaces Requirement R2 of the continent-wide standard in its entirety and adds a new requirement, Requirement D.A.5., applicable to Planning Coordinators in the Quebec Interconnection.

In Requirements R1, R3, and R4, all references to “Generator Owner” are replaced with “Generator Owner and Transmission Owner.”

This Variance replaces continent-wide Requirement R2 in its entirety with the following:

D.A.2. Each Generator Owner and Transmission Owner shall set its applicable voltage protection⁵ in accordance with PRC-024 Attachment 2a, such that the applicable protection does not cause the generating resource to trip or cease injecting current during a voltage excursion within the “no trip zone” at the high side of the GSU or MPT, subject to the following exceptions: *[Violation Risk Factor: Medium] [Time Horizon: Long-term Planning]*

- For newly designated strategic power plants, applicable protections must comply with the high voltage durations for such plants within 48 calendar months of the notification made pursuant to Requirement D.A.5. During this transition period, voltage protections must at least comply with the high voltage durations for “all power plants”.
- The generating resource(s) are permitted to be set to trip or to cease injecting current during a voltage excursion bounded by the “no trip zone” of PRC-024 Attachment 2a for documented and communicated regulatory or equipment limitations in accordance with Requirement R3.
- If the Transmission Planner allows less stringent voltage protection settings than those required to meet PRC-024 Attachment 2a, then the Generator Owner or Transmission Owner may set its protection within the voltage recovery characteristics of a location-specific Transmission Planner’s study.
- Inverter-based resources voltage protection settings may be set to cease injecting current momentarily during a voltage excursion at the high side of the MPT, bounded by the “no trip zone” of PRC-024 Attachment 2a, under the following conditions:

- After a minimum delay of 0.022 s, when the positive-sequence voltage exceeds 1.25 per unit (p.u.) Normal operation must resume once the voltage drops back below 1.25 p.u at the high side of the MPT.
- After a minimum delay of 0.022 s, when the phase-to-ground root mean square (RMS) voltages exceeds 1.4 p.u., as measured at generator terminals, on one or multiple phases. Normal operation must resume once the positive-sequence voltage drops back below the 1.25 p.u. at the high side of the MPT.

M.D.A.2. Each Generator Owner and Transmission Owner shall have evidence that applicable voltage protection has been set in accordance with Requirement R2, such as dated setting sheets, voltage-time boundaries, calibration sheets, coordination plots, dynamic simulation studies, calculations, or other documentation.

This Variance adds the following Requirement:

- D.A.5** Each Planning Coordinator shall designate, at least once every five calendar years, the strategic power plants that must comply with Attachment 2a and notify, within 30 calendar days of its designation, each Generator Owner or Transmission Owner that owns facilities⁷ in the strategic power plants. [*Violation Risk Factor: Medium*] [*Time Horizon: Long-term planning*]
- M.D.A.5** Each Planning Coordinator shall have evidence that it designated, at least once every five calendar years, strategic power plants in accordance with Requirement D.A.5, Part 5 and shall have dated evidence that each Generator Owner or Transmission Owner has been notified in accordance with Requirement D.A.5, part 5.2. Evidence may include, but is not limited to: letters, emails, electronic files, or hard copy records demonstrating transmittal of information.

⁷ Facilities in the strategic power plants include facilities from the generator up to and including the MPT or GSU.

Violation Severity Levels

This Variance adds a VSL for D.A.5 and modifies the VSL for R2 as follows:

R #	Violation Severity Levels			
	Lower VSL	Moderate VSL	High VSL	Severe VSL
D.A.2.	N/A	N/A	N/A	<p>The Generator Owner or Transmission Owner failed to set its applicable voltage protection so that it does not trip or cease injecting current in accordance with Requirement D.A.2.</p> <p>OR</p> <p>The Generator Owner or Transmission Owner set its applicable voltage protection in accordance with Requirement D.A.2 but, for strategic power plants, failed to do so within 48 months of notification.</p>
D.A.5.	N/A	The Planning Coordinator designated strategic power plants at least once every five calendar years but notified each Generator Owner or Transmission Owner that owns	The Planning Coordinator designated strategic power plants at least once every five calendar years but notified each Generator Owner or Transmission Owner that owns	The Planning Coordinator failed to designate, at least once every five years, the strategic power plants that must comply with Attachment 2a.

R #	Violation Severity Levels			
	Lower VSL	Moderate VSL	High VSL	Severe VSL
		facilities in the strategic power plants between 31 days and 45 days after its designation.	facilities in the strategic power plants between 46 days and 60 days after its designation.	OR The Planning Coordinator failed to notify, each Generator Owner or Transmission Owner that owns facilities in the strategic power plants or notified them more than 60 days after the its designation.

E. Associated Documents

Implementation Plan

Version History

Version	Date	Action	Change Tracking
1	May 9, 2013	Adopted by the NERC Board of Trustees	
1	March 20, 2014	FERC Order issued approving PRC-024-1. (Order becomes effective on 7/1/16.)	
2	February 12, 2015	Adopted by the NERC Board of Trustees	Standard revised in Project 2014-01: Applicability revised to clarify application of requirements to BES dispersed power producing resources
2	May 29, 2015	FERC Letter Order in Docket No. RD15-3-000 approving PRC-024-2	Modifications to adjust the applicability to owners of dispersed generation resources.
3	February 6, 2020	Adopted by the NERC Board of Trustees	Standard revised in Project 2018-04

Attachment 1 (Frequency No Trip Boundaries by Interconnection⁸)

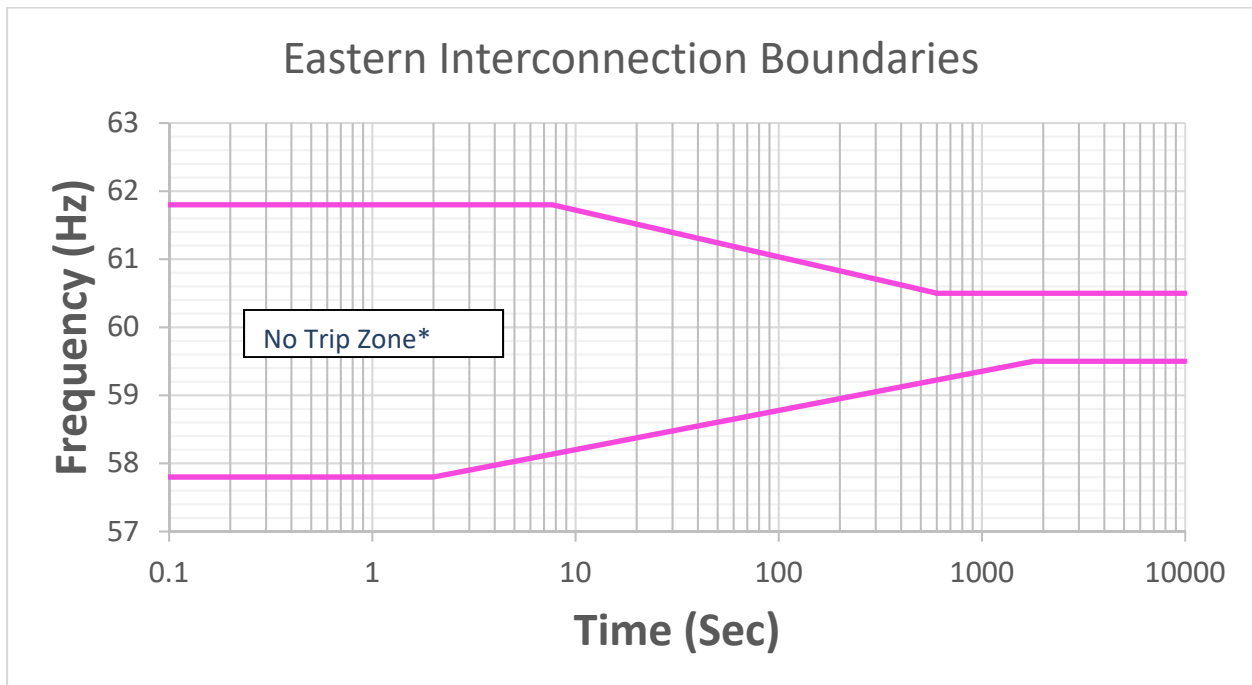

Figure 1

** The area outside the "No Trip Zone" is not a "Must Trip Zone."*

Frequency Boundary Data Points - Eastern Interconnection

High Frequency Duration		Low Frequency Duration	
Frequency (Hz)	Minimum Time (Sec)	Frequency (Hz)	Minimum Time (sec)
≥61.8	Instantaneous ⁹	≤57.8	Instantaneous ⁹
≥60.5	$10^{(90.935-1.45713*f)}$	≤59.5	$10^{(1.7373*f-100.116)}$
<60.5	Continuous operation	> 59.5	Continuous operation

Table 1

⁸ The figures do not visually represent the “no trip zone” boundaries before 0.1 seconds and after 10,000 seconds. The Frequency Boundary Data Points Table defines the entirety of the “no trip zone” boundaries.

⁹ Frequency is calculated over a window of time. While the frequency boundaries include the option to trip instantaneously for frequencies outside the specified range, this calculation should occur over a time window. Typical window/filtering lengths are three to six cycles (50 – 100 milliseconds). Instantaneous trip settings based on instantaneously calculated frequency measurement is not permissible.

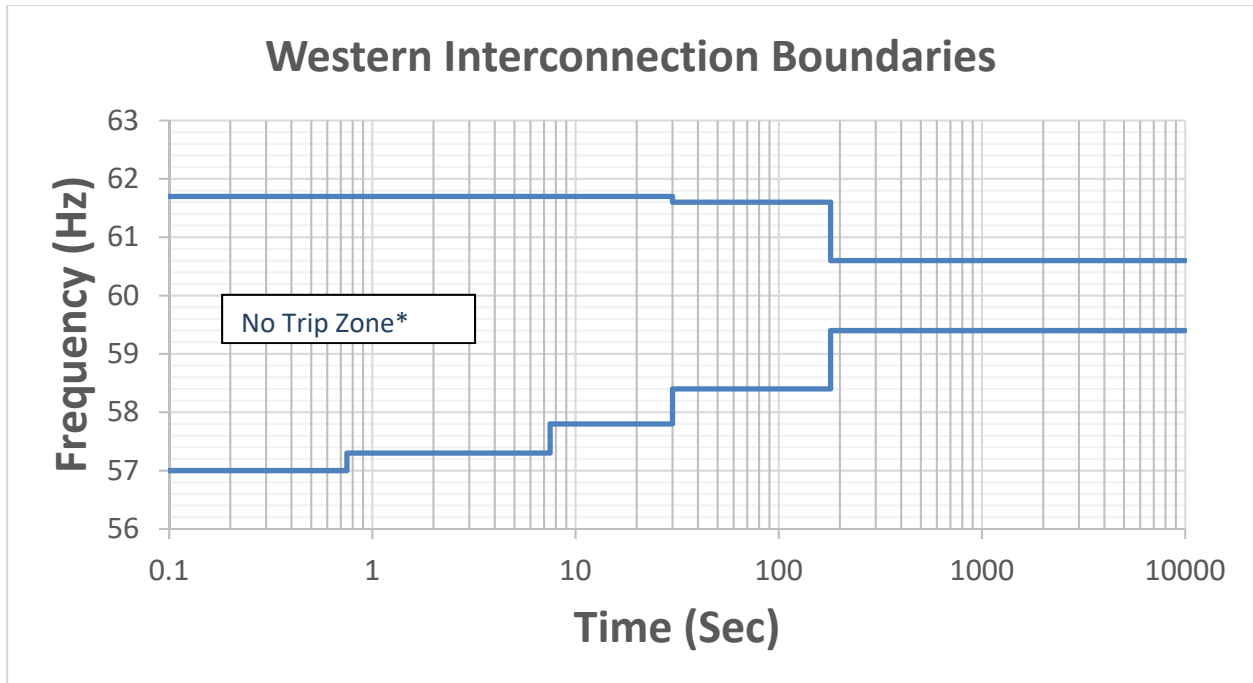

Figure 2

* The area outside the "No Trip Zone" is not a "Must Trip Zone."

Frequency Boundary Data Points –Western Interconnection

High Frequency Duration		Low Frequency Duration	
Frequency (Hz)	Minimum Time (Sec)	Frequency (Hz)	Minimum Time (sec)
≥61.7	Instantaneous ⁹	≤57.0	Instantaneous ⁹
≥61.6	30	≤57.3	0.75
≥60.6	180	≤57.8	7.5
<60.6	Continuous operation	≤58.4	30
		≤59.4	180
		>59.4	Continuous operation

Table 2

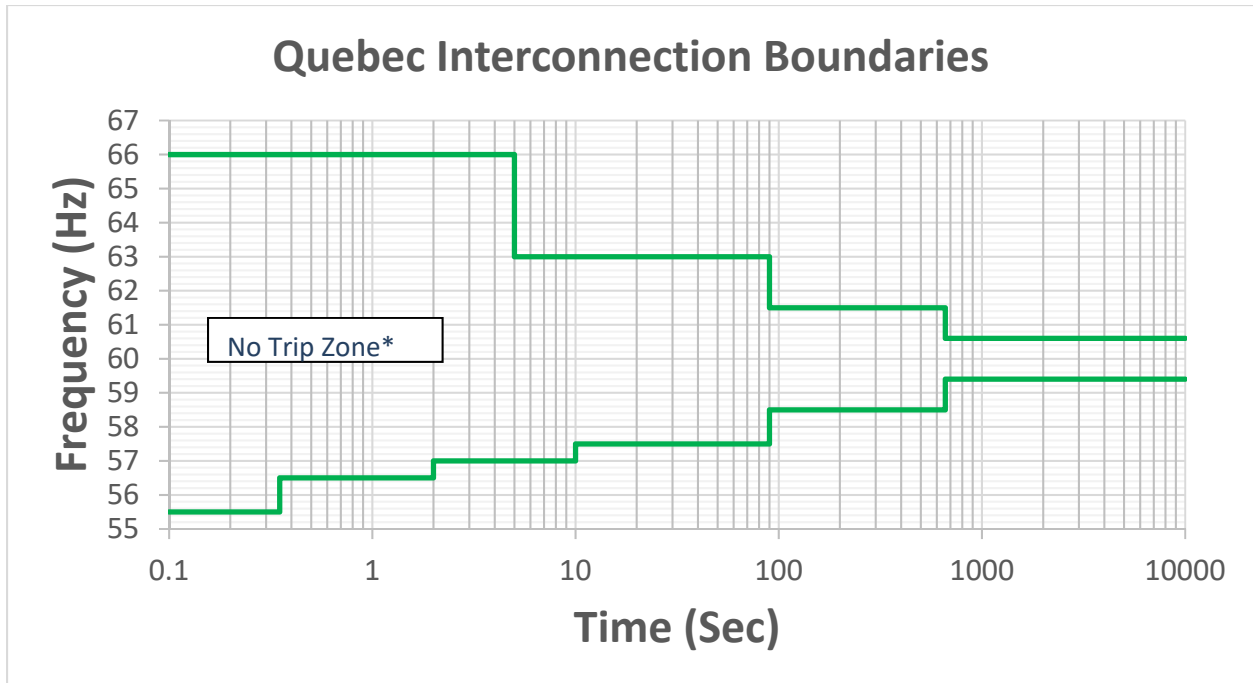

Figure 3

* The area outside the "No Trip Zone" is not a "Must Trip Zone."

Frequency Boundary Data Points – Quebec Interconnection

High Frequency Duration		Low Frequency Duration	
Frequency (Hz)	Minimum Time (Sec)	Frequency (Hz)	Minimum Time (Sec)
>66.0	Instantaneous ⁹	<55.5	Instantaneous ⁹
≥63.0	5	≤56.5	0.35
≥61.5	90	≤57.0	2
≥60.6	660	≤57.5	10
<60.6	Continuous operation	≤58.5	90
		≤59.4	660
		>59.4	Continuous operation

Table 3

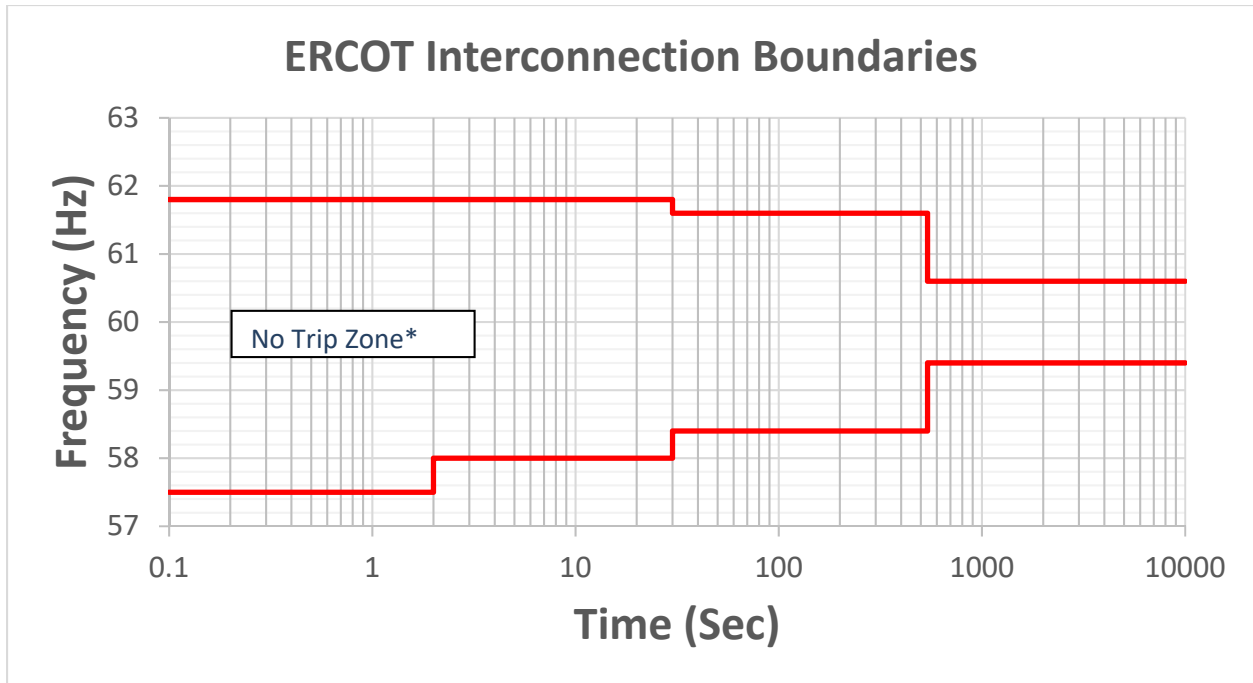

Figure 4

* The area outside the "No Trip Zone" is not a "Must Trip Zone."

Frequency Boundary Data Points – ERCOT Interconnection

High Frequency Duration		Low Frequency Duration	
Frequency (Hz)	Minimum Time (Sec)	Frequency (Hz)	Minimum Time (sec)
≥61.8	Instantaneous ⁹	≤57.5	Instantaneous ⁹
≥61.6	30	≤58.0	2
≥60.6	540	≤58.4	30
<60.6	Continuous operation	≤59.4	540
		>59.4	Continuous operation

Table 4

PRC-024 — Attachment 2

(Voltage No-Trip Boundaries – Eastern, Western, and ERCOT Interconnections)

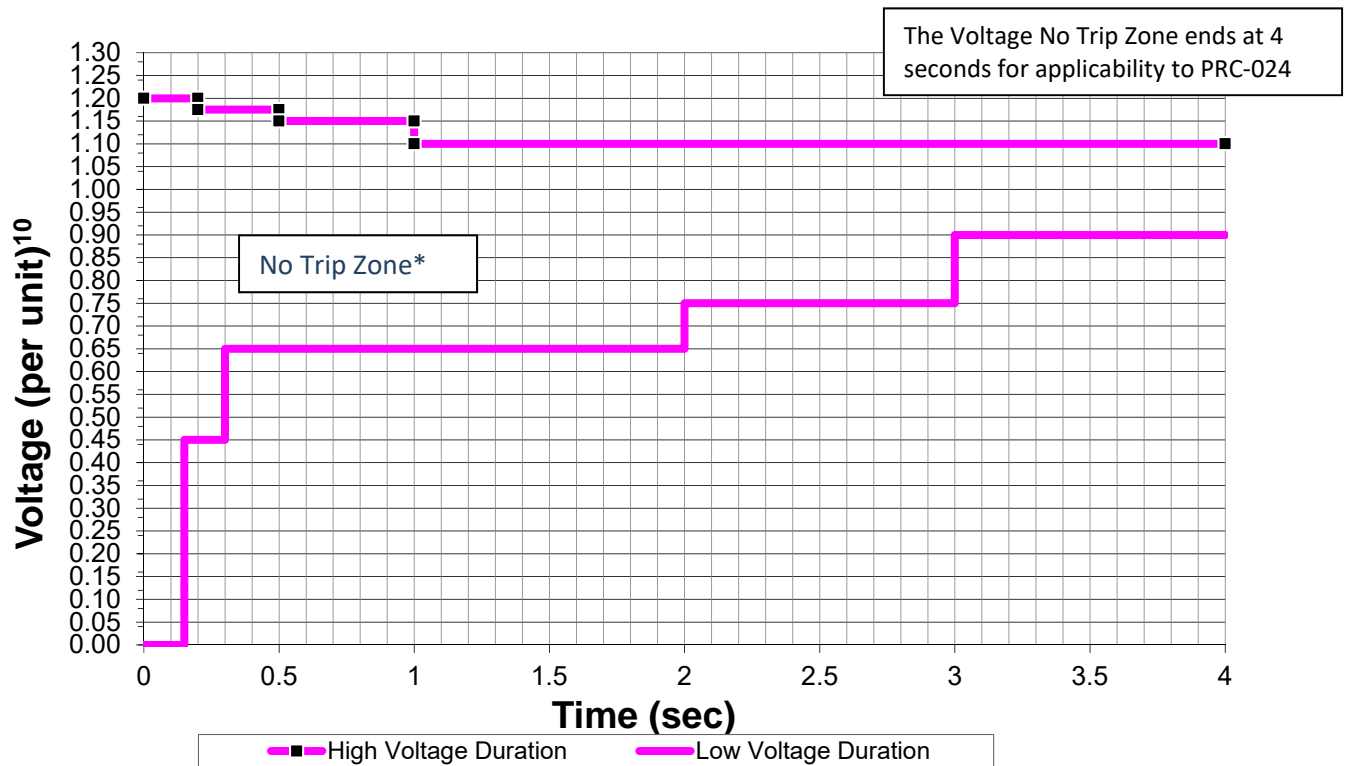

Figure 1

** The area outside the "No Trip Zone" is not a "Must Trip Zone."*

Voltage Boundary Data Points

High Voltage Duration		Low Voltage Duration	
Voltage (pu)	Minimum Time (sec)	Voltage (pu)	Minimum Time (sec)
≥1.200	0.00	<0.45	0.15
≥1.175	0.20	<0.65	0.30
≥1.15	0.50	<0.75	2.00
≥1.10	1.00	<0.90	3.00
<1.10	4.00	≥ 0.90	4.00

Table 1

¹⁰Voltage at the high-side of the GSU or MPT.

Attachment 2: Voltage Boundary Clarifications – Eastern, Western, and ERCOT Interconnections

Boundary Details:

1. Unless otherwise specified by the Transmission Planner, the per unit voltage base for these boundaries is the nominal transmission system voltage (e.g., 100 kV, 115 kV, 138 kV, 161 kV, 230 kV, 345 kV, 400 kV, 500 kV, 765 kV, etc.).
2. The values in the table represent the minimum time durations allowed for specified voltage excursion thresholds.
3. When evaluating volts per hertz protection, either assume a system frequency of 60 Hertz or the magnitude of the high voltage boundary can be adjusted in proportion to deviations of frequency below 60 Hertz.
4. Voltages in the boundaries assume RMS fundamental frequency phase-to-ground or phase-to-phase per unit voltage.
5. For applicability to PRC-024, the “no trip zone” ends at 4 seconds.

Evaluating Protection Settings:

The voltage values in the Attachment 2 voltage boundaries are voltages at the high side of the GSU/MPT. For generating resources with multiple stages of step up to reach interconnecting voltage, this is the high side of the transformer with a low side below 100kV and a high side 100kV or above. When evaluating protection settings, consider the voltage differences between where the protection is measuring voltage and the high side of the GSU/MPT. A steady state calculation or dynamic simulation may be used.

If using a steady state calculation or dynamic simulation, use the following conditions when evaluating protection settings:

- a. The most probable real and reactive loading conditions for the unit under study.
- b. All installed generating plant reactive support (e.g., static VAR compensators, synchronous condensers, capacitors) equipment is available and operating normally.
- c. Account for the actual tap settings of transformers between the generator terminals and the high side of the GSU/MPT.
- d. For dynamic simulations, the automatic voltage regulator is in automatic voltage control mode with associated limiters in service.

PRC-024— Attachment 2a (Voltage No-Trip Boundaries – Quebec Interconnection)

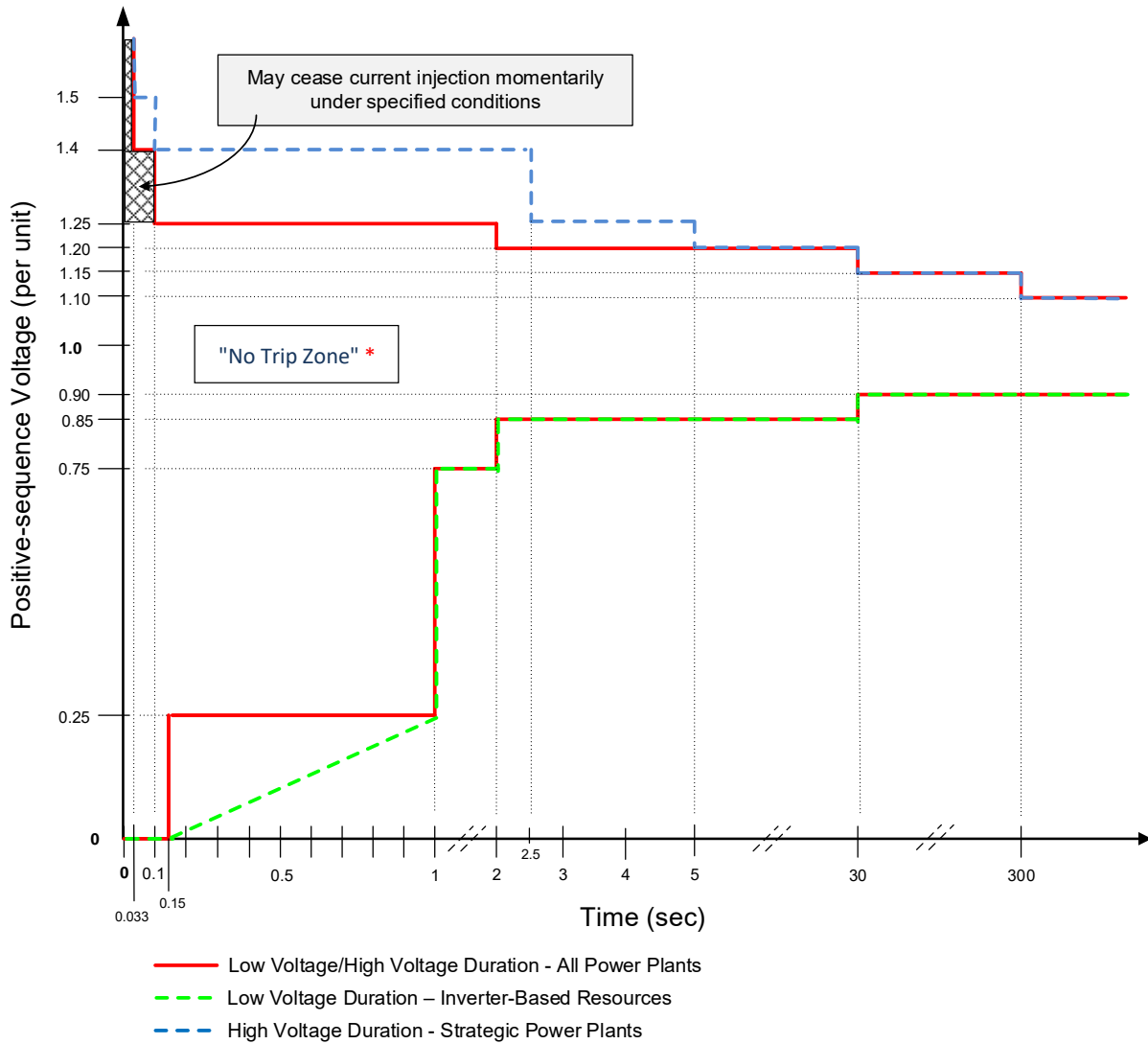

Figure 1

*** The area outside the "No Trip Zone" is not a "Must Trip Zone."**

Voltage Boundary Data Points – Quebec Interconnection

High Voltage Duration for all Power Plants		High Voltage Duration for strategic Power Plants	
Voltage (pu)	Minimum Time (sec)	Voltage (pu)	Minimum Time (sec)
---	---	>1.50	0.033
>1.40	0.033	>1.40	0.10
>1.25	0.10	>1.25	2.50
>1.20	2.00	>1.20	5.00
>1.15	30	>1.15	30
>1.10	300	>1.10	300
≤1.10	continuous	≤1.10	continuous

Table 1

Voltage Boundary Data Points – Quebec Interconnection

Low Voltage Duration for all Power Plants		Low Voltage Duration for Inverter-Based Resources	
Voltage (pu)	Minimum Time (sec)	Voltage (pu)	Minimum Time (sec)
<0.25	0.15	<0.25	$3.4 * V(\text{pu}) + 0.15$
<0.75	1.00	<0.75	1.00
<0.85	2.00	<0.85	2.00
<0.90	30	<0.90	30
≥0.90	continuous	≥0.90	continuous

Table 2

Attachment 2a: Voltage Boundary Clarifications – Quebec Interconnection

Boundary Details:

1. The per unit voltage base for these boundaries is the nominal operating voltage (e.g., 120 kV, 161 kV, 230 kV, 315 kV, 735 kV, etc.).
2. The values in the table represent the minimum time durations allowed for specified voltage excursion thresholds.
3. When evaluating volts per hertz protection, either assume a system frequency of 60 Hertz or the magnitude of the high voltage boundary can be adjusted in proportion to deviations of frequency below 60 Hertz.
4. Voltages in the Quebec Interconnection boundaries assume positive-sequence values.

Evaluating Protection Settings:

The voltage values in the Attachment 2a voltage boundaries are voltages at the high side of the GSU/MPT. For generating resources with multiple stages of step up to reach interconnecting voltage, this is the high side of the transformer that connects to the interconnecting voltage. When evaluating protection settings, consider the voltage differences between where the protection is measuring voltage and the high side of the GSU/MPT. A steady state calculation or dynamic simulation may be used.

If using a steady state calculation or dynamic simulation, use the following conditions when evaluating protection settings:

- a. The most probable real and reactive loading conditions for the unit under study.
- b. All installed generating plant reactive support (e.g., static VAR compensators, synchronous condensers, capacitors) equipment is available and operating normally.
- c. Account for the actual tap settings of transformers between the generator terminals and the high side of the GSU/MPT.
- d. For dynamic simulations, the automatic voltage regulator is in automatic voltage control mode with associated limiters in service.

Exhibit A

**Proposed Reliability Standard PRC-024-3
Frequency and Voltage Protection Settings for Generating Resources**

Redline

A. Introduction

1. **Title:** ~~Generator Frequency and Voltage Protective Relay Settings for Generating Resources~~
2. **Number:** PRC-024-~~23~~
3. **Purpose:** ~~Ensure Generator Owners To set their generator protection relays~~ such that generating ~~resource(s) units~~ remain connected during defined frequency and voltage excursions ~~in support of the Bulk Electric System (BES).~~
4. **Applicability:**

4.1. Generator Owner Functional Entities:

4.1.1 Generator Owners that apply protection listed in Section 4.2.1.

4.1.2 Transmission Owners (in the Quebec Interconnection only) that own a BES generator step-up (GSU) transformer or main power transformer (MPT)¹ and apply protection listed in Section 4.2.1.

4.1.3 Planning Coordinators (in the Quebec Interconnection only)

4.2. Facilities²:

4.2.1 Frequency, voltage, and volts per hertz protection (whether provided by relaying or functions within associated control systems) that respond to electrical signals and: (i) directly trip the generating resource(s); or (ii) provide signals to the generating resource(s) to either trip or cease injecting current; and are applied to the following:

4.2.1.1 BES generating resource(s).

4.2.1.2 BES GSU transformer(s).

4.2.1.3 High side of the generator-connected unit auxiliary transformer³ (UAT) installed on BES generating resource(s).

4.2.1.4 Individual dispersed power producing resource(s) identified in the BES Definition, Inclusion I4.

4.2.1.5 Elements that are designed primarily for the delivery of capacity from the individual dispersed power producing resources

¹ For the purpose of this standard, the MPT is the power transformer that steps up voltage from the collection system voltage to the nominal transmission/interconnecting system voltage for dispersed power producing resources.

² It is not required to install or activate the protections described in Facilities Section 4.2.

³ These transformers are variably referred to as station power UAT, or station service transformer(s) used to provide overall auxiliary power to the generating resource(s). This UAT is the transformer connected on the generator bus between the low side of the GSU and the generator terminal.

Standard PRC-024-23 — Generator Frequency and Voltage Protective Relay Settings for Generating Resources

identified in the BES Definition, Inclusion I4, to the point where those resources aggregate to greater than 75 MVA.

4.2.1.6 MPT⁴ of resource(s) identified in the BES Definition, Inclusion I4.

4.2.2 Exemptions: Protection on all auxiliary equipment within the generating Facility.

5. Effective Date: See the Implementation Plan for PRC-024-23.

⁴ For the purpose of this standard, the MPT is the power transformer that steps up voltage from the collection system voltage to the nominal transmission/interconnecting system voltage for dispersed power producing resources

B. Requirements and Measures

R1. Each Generator Owner shall set its applicable frequency protection⁵ that has generator frequency protective relaying¹ activated to trip its applicable generating unit(s) shall set its protective relaying in accordance with PRC-024 Attachment 1 such that the generator frequency protective relaying does not trip the applicable generating unit(s) protection does not cause the generating resource to trip or cease injecting current within the “no trip zone” of PRC-024 Attachment 1, subject to during a frequency excursion with the following exceptions:² [*Violation Risk Factor: Medium*] [*Time Horizon: Long-term Planning*]

- ~~Generating unit(s) Applicable frequency protection may may trip if the protective functions (such as out of step functions or loss of field functions) operate due to an impending be set to trip or cease injecting current within a portion of the “no trip zone” for documented and communicated regulatory or equipment limitations in accordance with Requirement R3. actual loss of synchronism or, for asynchronous generating units, due to instability in power conversion control equipment.~~

~~Generating unit(s) may trip if clearing a system fault necessitates disconnecting (a) generating unit(s).~~

~~**M1.** Generating unit(s) may trip within a portion of the “no trip zone” of PRC-024 Attachment 1 for documented and communicated regulatory or equipment limitations in accordance~~

⁵ Frequency, voltage, and volts per hertz protection (whether provided by relaying or functions within associated control systems) that respond to electrical signals and: (i) directly trip the generating resource(s); or (ii) provide signals to the generating resource(s) to either trip or cease injecting current.

¹ Each Generator Owner is not required to have frequency or voltage protective relaying (including but not limited to frequency and voltage protective functions for discrete relays, volts per hertz relays evaluated at nominal frequency, multi-function protective devices or protective functions within control systems that directly trip or provide tripping signals to the generator based on frequency or voltage inputs) installed or activated on its unit.

² For frequency protective relays associated with dispersed power producing resources identified through Inclusion I4 of the Bulk Electric System definition, this requirement applies to frequency protective relays applied on the individual generating unit of the dispersed power producing resources, as well as frequency protective relays applied on equipment from the individual generating unit of the dispersed power producing resource up to the point of interconnection.

³ For the purposes of this standard, point of interconnection means the transmission (high voltage) side of the generator step up or collector transformer.

⁴ For voltage protective relays associated with dispersed power producing resources identified through Inclusion I4 of the Bulk Electric System definition, this requirement applies to voltage protective relays applied on the individual generating unit of the dispersed power producing resources, as well as voltage protective relays applied on equipment from the individual generating unit of the dispersed power producing resource up to the point of interconnection.

~~with Requirement R3. Each Generator Owner shall have evidence that the generator applicable frequency protective relays have been set in accordance with Requirement R1, such as dated setting sheets, calibration sheets, calculations, or other documentation.~~

R2. Each Generator Owner ~~shall set its applicable voltage protection⁵⁵ in accordance with PRC-024 Attachment 2, that has generator voltage protective relaying⁴ activated to trip its applicable generating unit(s) shall set its protective relaying such that the generator voltage protective relaying does not trip the applicable protection does not cause the generating resource to trip or cease injecting current within the “no trip zone” during a voltage excursion at the high side of the GSU or MPT, generating unit(s) as a result of a voltage excursion (at the point of interconnection³) caused by an event on the transmission system external to the generating plant that remains within the “no trip zone” of PRC-024 Attachment 2.~~⁴ If the Transmission Planner allows less stringent voltage relay settings than those required to meet PRC-024 Attachment 2, then the Generator Owner shall set its protective relaying within the voltage recovery characteristics of a location-specific Transmission Planner’s study. Requirement R2 is subject to the following exceptions: [*Violation Risk Factor: Medium*] [*Time Horizon: Long-term Planning*]

- ~~If the Transmission Planner allows less stringent voltage protection settings than those required to meet PRC-024 Attachment 2, then the Generator Owner may set its protection within the voltage recovery characteristics of a location-specific Transmission Planner’s study.~~
- ~~Generating unit(s) may trip in accordance with a Special Protection System (SPS) or Remedial Action Scheme (RAS).~~
- ~~Generating unit(s) may trip if clearing a system fault necessitates disconnecting (a) generating unit(s).~~
- ~~Generating unit(s) may trip by action of protective functions (such as out-of-step functions or loss-of-field functions) that operate due to an impending or actual loss of synchronism or, for asynchronous generating units, due to instability in power conversion control equipment.~~
- ~~Generating unit(s) may~~ Applicable voltage protection may be set to trip or cease injecting current during a voltage excursion within a portion of the “no trip zone” of PRC-024 Attachment 2 for documented and communicated regulatory or equipment limitations in accordance with Requirement R3.

M2. Each Generator Owner shall have evidence that ~~generator applicable voltage protective relays have~~ been set in accordance with Requirement R2, such as dated setting sheets, voltage-time curves boundaries, calibration sheets, coordination plots, dynamic simulation studies, calculations, or other documentation.

R3. Each Generator Owner shall document each known regulatory or equipment limitation⁶ that prevents an applicable generating resource(s) unit with ~~generator~~ frequency or voltage protective ~~veon~~ relays from meeting the relay protection setting criteria in Requirements R1 or R2, including (but not limited to) study results, experience from an actual event, or manufacturer's advice. *[Violation Risk Factor: Lower] [Time Horizon: Long-term Planning]*

3.1. The Generator Owner shall communicate the documented regulatory or equipment limitation, or the removal of a previously documented regulatory or equipment limitation, to its Planning Coordinator and Transmission Planner within 30 calendar days of any of the following:

- Identification of a regulatory or equipment limitation.
- Repair of the equipment causing the limitation that removes the limitation.
- Replacement of the equipment causing the limitation with equipment that removes the limitation.
- Creation or adjustment of an equipment limitation caused by consumption of the cumulative turbine life-time frequency excursion allowance.

M3. Each Generator Owner shall have evidence that it has documented and communicated any known regulatory or equipment limitations (excluding limitations noted in footnote 3) that resulted in an exception to Requirements R1 or R2 in accordance with Requirement R3, such as a dated email or letter that contains such documentation as study results, experience from an actual event, or manufacturer's advice.

R4. Each Generator Owner shall provide its applicable ~~generator~~ protection ~~trip~~ settings associated with Requirements R1 and R2 to the Planning Coordinator or Transmission Planner that models the associated unit-generating resource(s) within 60 calendar days of receipt of a written request for the data and within 60 calendar days of any change to those previously requested ~~trip~~ settings unless directed by the requesting Planning Coordinator or Transmission Planner that the reporting of relay protection setting changes is not required. *[Violation Risk Factor: Lower] [Time Horizon: Operations Planning]*

~~**M1.** Each Generator Owner shall have evidence that generator frequency protective relays have been set in accordance with Requirement R1 such as dated setting sheets, calibration sheets or other documentation.~~

⁶ Excludes limitations ~~that are~~ caused by the setting capability of the ~~generator~~ frequency, ~~and~~ voltage, and volts per hertz protective relays ~~themselves for the generating resource(s). This~~ but does not exclude limitations originating in the equipment ~~that they~~ protected by the relay. This also does not exclude limitations of frequency, voltage, and volts per hertz protection embedded in control systems.

Standard PRC-024-23 — ~~Generator~~ Frequency and Voltage Protective ~~on Relay~~ Settings for Generating Resources

~~**M2-M1.** Each Generator Owner shall have evidence that generator voltage protective relays have been set in accordance with Requirement R2 such as dated setting sheets, voltage time curves, calibration sheets, coordination plots, dynamic simulation studies or other documentation.~~

~~**M3-M1.** Each Generator Owner shall have evidence that it has documented and communicated any known regulatory or equipment limitations (excluding limitations noted in footnote 3) that resulted in an exception to Requirements R1 or R2 in accordance with Requirement R3 such as a dated email or letter that contains such documentation as study results, experience from an actual event, or manufacturer's advice.~~

M4. Each Generator Owner shall have evidence that it communicated applicable ~~generator protective relay tripprotection~~ settings in accordance with Requirement R4, such as dated e-mails, correspondence or other evidence and copies of any requests it has received for that information.

C. Compliance

1. Compliance Monitoring Process

1.1. Compliance Enforcement Authority: “Compliance Enforcement Authority” means NERC or the Regional Entity, or any entity as otherwise designated by an Applicable Governmental Authority, in their respective roles of monitoring and/or enforcing compliance with mandatory and enforceable Reliability Standards in their respective jurisdictions.

~~The Regional Entity shall serve as the Compliance Enforcement Authority (CEA) unless the applicable entity is owned, operated, or controlled by the Regional Entity. In such cases, the ERO or a Regional Entity approved by FERC or other applicable governmental authority shall serve as the CEA.~~

~~1.2. Data Evidence Retention:~~

1.2. The following evidence retention period(s) identify the period of time an entity is required to retain specific evidence to demonstrate compliance. ~~For instances where the evidence retention period specified below is shorter than the time since the last audit, the Compliance Enforcement Authority may ask an entity to provide other evidence to show that it was compliant for the full-time period since the last audit.~~

The applicable entity shall keep data or evidence to show compliance as identified below unless directed by its Compliance Enforcement Authority to retain specific evidence for a longer period of time as part of an investigation.

- The Generator Owner shall ~~retain~~ keep data or evidence ~~of compliance with~~ Requirement R1 through R4; for 3 years or until the next audit, whichever is longer.
- If a Generator Owner is found non-compliant, the Generator Owner or Transmission Owner shall keep information related to the non-compliance until mitigation is complete and approved for the time period specified above, whichever is longer.

~~The Compliance Enforcement Authority shall keep the last audit records and all requested and submitted subsequent audit records.~~

1.3. Compliance Monitoring and Assessment ~~Processes~~Program: As defined in the NERC Rules of Procedure, “Compliance Monitoring and Enforcement Program” refers to the identification of the processes that will be used to evaluate data or information for the purpose of assessing performance or outcomes with the associated Reliability Standard.

~~Compliance Audit~~

~~Self-Certification~~

~~Spot Checking~~

~~Compliance Investigations~~

~~Self-Reporting~~

~~Complaint~~

Violation Severity Levels

R #	Violation Severity Levels			
	Lower VSL	Moderate VSL	High VSL	Severe VSL
R1.	N/A	N/A	N/A	The Generator Owner that has failed to set its applicable frequency protection activated to trip a generating unit, failed to set its generator frequency protective relaying so that it does not trip within the criteria listed in or cease injecting current according to Requirement R1 unless there is a documented and communicated regulatory or equipment limitation per Requirement R3.
R2.	N/A	N/A	N/A	The Generator Owner with voltage protective relaying activated to trip a generating unit, failed to set its applicable voltage protective relaying protection so that it does not trip as a result of a voltage excursion at the point of interconnection, caused by an event external

R #	Violation Severity Levels			
	Lower VSL	Moderate VSL	High VSL	Severe VSL
				to the plant per the criteria specified in or cease injecting current according to Requirement R2 unless there is a documented and communicated regulatory or equipment limitation per Requirement R3.
R3.	The Generator Owner documented the known non-protection system equipment limitation that prevented it from meeting the criteria in Requirement R1 or R2 and communicated the documented limitation to its Planning Coordinator and Transmission Planner more than 30 calendar days but less than or equal to 60 calendar days of identifying the limitation.	The Generator Owner documented the known non-protection system equipment limitation that prevented it from meeting the criteria in Requirement R1 or R2 and communicated the documented limitation to its Planning Coordinator and Transmission Planner more than 60 calendar days but less than or equal to 90 calendar days of identifying the limitation.	The Generator Owner documented the known non-protection system equipment limitation that prevented it from meeting the criteria in Requirement R1 or R2 and communicated the documented limitation to its Planning Coordinator and Transmission Planner more than 90 calendar days but less than or equal to 120 calendar days of identifying the limitation.	The Generator Owner failed to document any known non-protection system equipment limitation that prevented it from meeting the criteria in Requirement R1 or R2. OR The Generator Owner failed to communicate the documented limitation to its Planning Coordinator and Transmission Planner within 120 calendar days of identifying the limitation.

R #	Violation Severity Levels			
	Lower VSL	Moderate VSL	High VSL	Severe VSL
R4.	<p>The Generator Owner provided its generator protection trip settings more than 60 calendar days but less than or equal to 90 calendar days of any change to those trip settings.</p> <p>OR</p> <p>The Generator Owner provided trip protection settings more than 60 calendar days but less than or equal to 90 calendar days of a written request.</p>	<p>The Generator Owner provided its generator protection trip settings more than 90 calendar days but less than or equal to 120 calendar days of any change to those trip settings.</p> <p>OR</p> <p>The Generator Owner provided protection trip settings more than 90 calendar days but less than or equal to 120 calendar days of a written request.</p>	<p>The Generator Owner provided its generator protection trip settings more than 120 calendar days but less than or equal to 150 calendar days of any change to those trip settings.</p> <p>OR</p> <p>The Generator Owner provided protection trip settings more than 120 calendar days but less than or equal to 150 calendar days of a written request.</p>	<p>The Generator Owner failed to provide its generator protection trip settings within 150 calendar days of any change to those trip settings.</p> <p>OR</p> <p>The Generator Owner failed to provide protection trip settings within 150 calendar days of a written request.</p>

D. Regional Variances

~~None~~

D.A. Variance for the Quebec Interconnection

This Variance extends the applicability of Requirements R1, R3, and R4 to Transmission Owners in the Quebec Interconnection that own a BES GSU or MPT and apply protection listed in Section 4.2.1, Facilities. This Variance also replaces Requirement R2 of the continent-wide standard in its entirety and adds a new requirement, Requirement D.A.5., applicable to Planning Coordinators in the Quebec Interconnection.

In Requirements R1, R3, and R4, all references to “Generator Owner” are replaced with “Generator Owner and Transmission Owner.”

This Variance replaces continent-wide Requirement R2 in its entirety with the following:

D.A.2. Each Generator Owner and Transmission Owner shall set its applicable voltage protection⁵⁵ in accordance with PRC-024 Attachment 2a, such that the applicable protection does not cause the generating resource to trip or cease injecting current during a voltage excursion within the “no trip zone” at the high side of the GSU or MPT, subject to the following exceptions: *[Violation Risk Factor: Medium] [Time Horizon: Long-term Planning]*

- For newly designated strategic power plants, applicable protections must comply with the high voltage durations for such plants within 48 calendar months of the notification made pursuant to Requirement D.A.5. During this transition period, voltage protections must at least comply with the high voltage durations for “all power plants”.
- The generating resource(s) are permitted to be set to trip or to cease injecting current during a voltage excursion bounded by the “no trip zone” of PRC-024 Attachment 2a for documented and communicated regulatory or equipment limitations in accordance with Requirement R3.
- If the Transmission Planner allows less stringent voltage protection settings than those required to meet PRC-024 Attachment 2a, then the Generator Owner or Transmission Owner may set its protection within the voltage recovery characteristics of a location-specific Transmission Planner’s study.
- Inverter-based resources voltage protection settings may be set to cease injecting current momentarily during a voltage excursion at the

high side of the MPT, bounded by the “no trip zone” of PRC-024 Attachment 2a, under the following conditions:

- o After a minimum delay of 0.022 s, when the positive-sequence voltage exceeds 1.25 per unit (p.u.) Normal operation must resume once the voltage drops back below 1.25 p.u at the high side of the MPT.
- o After a minimum delay of 0.022 s, when the phase-to-ground root mean square (RMS) voltages exceeds 1.4 p.u., as measured at generator terminals, on one or multiple phases. Normal operation must resume once the positive-sequence voltage drops back below the 1.25 p.u. at the high side of the MPT.

M.D.A.2. Each Generator Owner and Transmission Owner shall have evidence that applicable voltage protection has been set in accordance with Requirement R2, such as dated setting sheets, voltage-time boundaries, calibration sheets, coordination plots, dynamic simulation studies, calculations, or other documentation.

This Variance adds the following Requirement:

D.A.5 Each Planning Coordinator shall designate, at least once every five calendar years, the strategic power plants that must comply with Attachment 2a and notify, within 30 calendar days of its designation, each Generator Owner or Transmission Owner that owns facilities⁷ in the strategic power plants. *[Violation Risk Factor: Medium] [Time Horizon: Long-term planning]*

M.D.A.5 Each Planning Coordinator shall have evidence that it designated, at least once every five calendar years, strategic power plants in accordance with Requirement D.A.5, Part 5 and shall have dated evidence that each Generator Owner or Transmission Owner has been notified in accordance with Requirement D.A.5, part 5.2. Evidence may include, but is not limited to: letters, emails, electronic files, or hard copy records demonstrating transmittal of information.

⁷ Facilities in the strategic power plants include facilities from the generator up to and including the MPT or GSU.

Violation Severity Levels

This Variance adds a VSL for D.A.5 and modifies the VSL for R2 as follows:

R.#	Violation Severity Levels			
	Lower VSL	Moderate VSL	High VSL	Severe VSL
<u>D.A.2.</u>	<u>N/A</u>	<u>N/A</u>	<u>N/A</u>	<p><u>The Generator Owner or Transmission Owner failed to set its applicable voltage protection so that it does not trip or cease injecting current in accordance with Requirement D.A.2.</u></p> <p><u>OR</u></p> <p><u>The Generator Owner or Transmission Owner set its applicable voltage protection in accordance with Requirement D.A.2 but, for strategic power plants, failed to do so within 48 months of notification.</u></p>
<u>D.A.5.</u>	<u>N/A</u>	<u>The Planning Coordinator designated strategic power plants at least once every five calendar years but notified each Generator Owner or Transmission Owner that owns</u>	<u>The Planning Coordinator designated strategic power plants at least once every five calendar years but notified each Generator Owner or Transmission Owner that owns</u>	<u>The Planning Coordinator failed to designate, at least once every five years, the strategic power plants that must comply with Attachment 2a.</u>

R.#	Violation Severity Levels			
	Lower VSL	Moderate VSL	High VSL	Severe VSL
		<u>facilities in the strategic power plants between 31 days and 45 days after its designation.</u>	<u>facilities in the strategic power plants between 46 days and 60 days after its designation.</u>	<u>OR</u> <u>The Planning Coordinator failed to notify, each Generator Owner or Transmission Owner that owns facilities in the strategic power plants or notified them more than 60 days after the its designation.</u>

E. Associated Documents

~~None~~ Implementation Plan

Version History

<u>Version</u>	<u>Date</u>	<u>Action</u>	<u>Change Tracking</u>
<u>1</u>	<u>May 9, 2013</u>	<u>Adopted by the NERC Board of Trustees</u>	
<u>1</u>	<u>March 20, 2014</u>	<u>FERC Order issued approving PRC-024-1. (Order becomes effective on 7/1/16.)</u>	
<u>2</u>	<u>February 12, 2015</u>	<u>Adopted by the NERC Board of Trustees</u>	<u>Standard revised in Project 2014-01: Applicability revised to clarify application of requirements to BES dispersed power producing resources</u>
<u>2</u>	<u>May 29, 2015</u>	<u>FERC Letter Order in Docket No. RD15-3-000 approving PRC-024-2</u>	<u>Modifications to adjust the applicability to owners of dispersed generation resources.</u>
<u>3</u>	<u>February 6, 2020</u>	<u>Adopted by the NERC Board of Trustees</u>	<u>Standard revised in Project 2018-04</u>

~~F. References~~

- ~~1. “The Technical Justification for the New WECC Voltage Ride-Through (VRT) Standard, A White Paper Developed by the Wind Generation Task Force (WGTF),” dated June 13, 2007, a guideline approved by WECC Technical Studies Subcommittee.~~

PRC-024 — Attachment 1

OFF NOMINAL FREQUENCY CAPABILITY CURVE

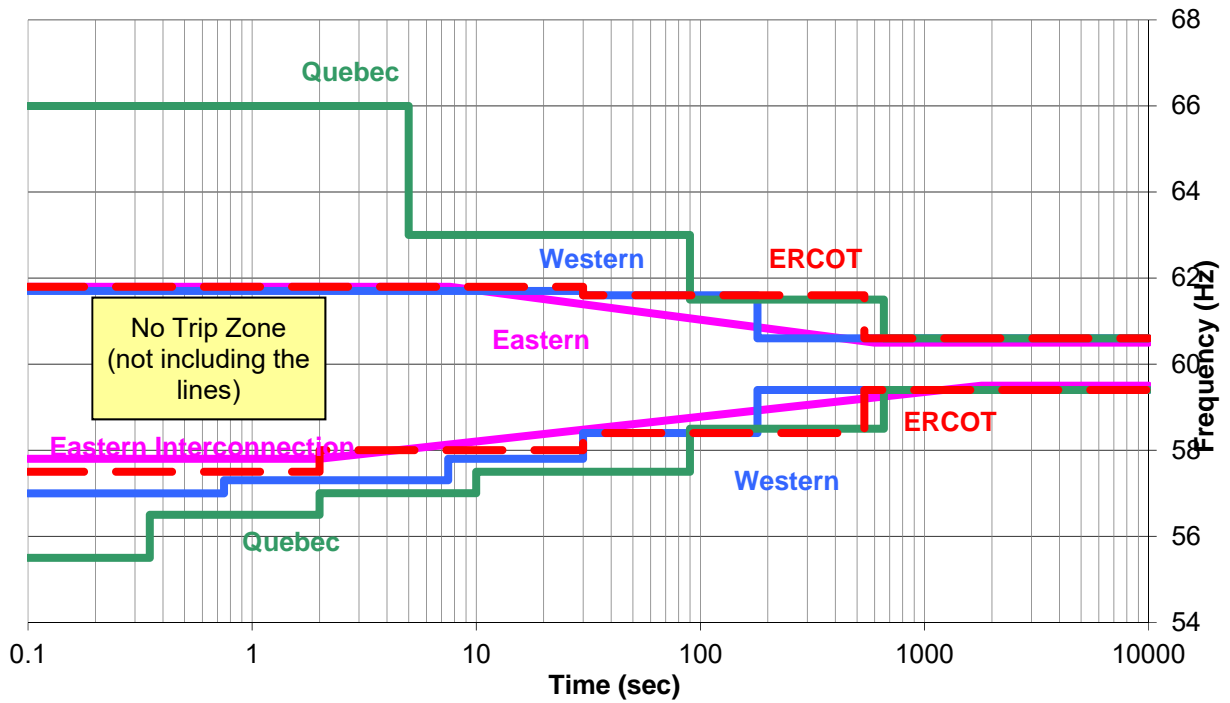

(Frequency No Trip Boundaries by Interconnection⁸)

⁸ The figures do not visually represent the “no trip zone” boundaries before 0.1 seconds and after 10,000 seconds. The Frequency Boundary Data Points Table defines the entirety of the “no trip zone” boundaries.

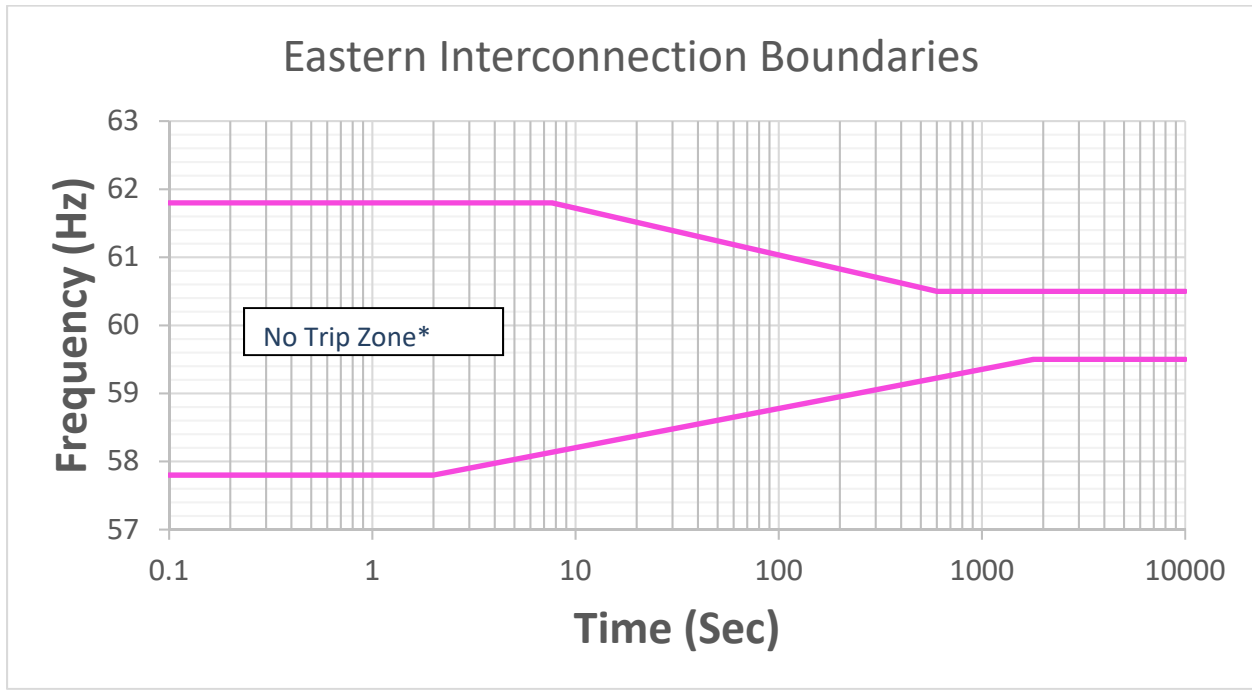

Figure 1

** The area outside the "No Trip Zone" is not a "Must Trip Zone."*

Curve-Frequency Boundary Data Points:

- Eastern Interconnection

High Frequency Duration		Low Frequency Duration	
Frequency (Hz)	Minimum Time (Sec)	Frequency (Hz)	Minimum Time (sec)
≥61.8	Instantaneous ⁹ trip	≤57.8	Instantaneous ⁹⁹ trip
≥60.5	$10^{(90.935-1.45713*f)}$	≤59.5	$10^{(1.7373*f-100.116)}$
<60.5	Continuous operation	> 59.5	Continuous operation

Table 1

⁹ Frequency is calculated over a window of time. While the frequency boundaries include the option to trip instantaneously for frequencies outside the specified range, this calculation should occur over a time window. Typical window/filtering lengths are three to six cycles (50 – 100 milliseconds). Instantaneous trip settings based on instantaneously calculated frequency measurement is not permissible.

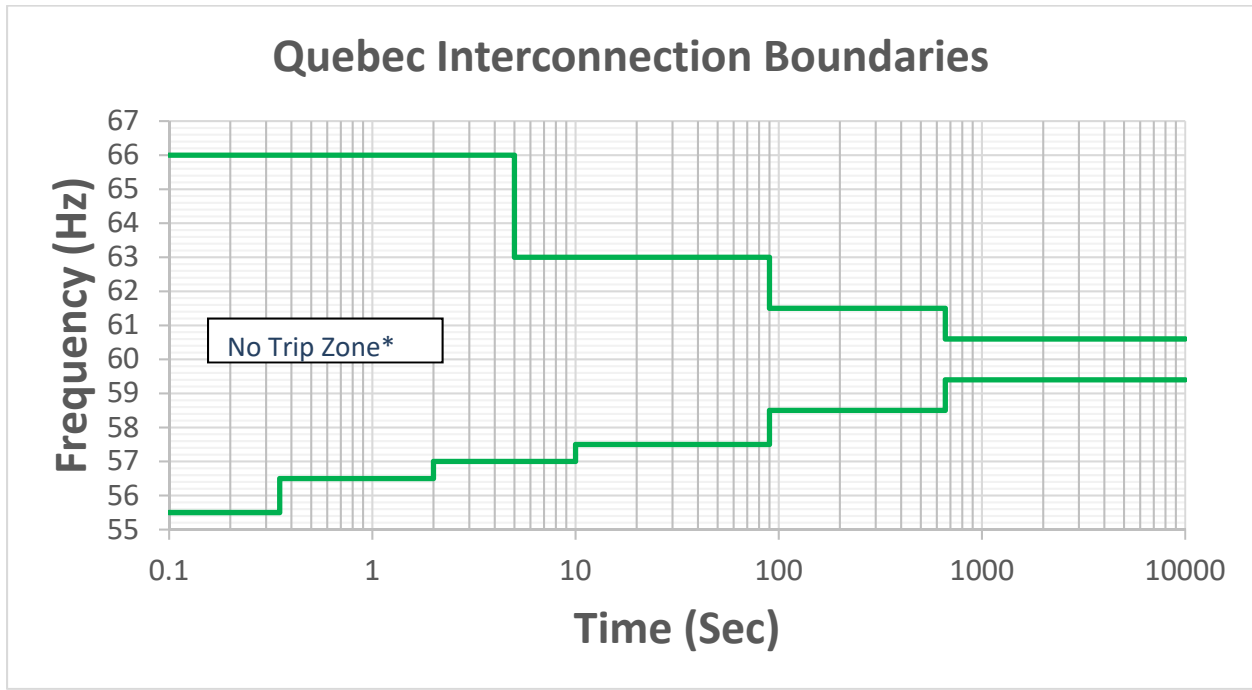

Figure 3

* The area outside the "No Trip Zone" is not a "Must Trip Zone."

Frequency Boundary Data Points – Quebec Interconnection

High Frequency Duration		Low Frequency Duration	
Frequency (Hz)	Minimum Time (Sec)	Frequency (Hz)	Minimum Time (Sec)
>66.0	Instantaneous ⁹⁹ trip	<55.5	Instantaneous ⁹⁹ trip
≥63.0	5	≤56.5	0.35
≥61.5	90	≤57.0	2
≥60.6	660	≤57.5	10
<60.6	Continuous operation	≤58.5	90
		≤59.4	660
		>59.4	Continuous operation

Table 3

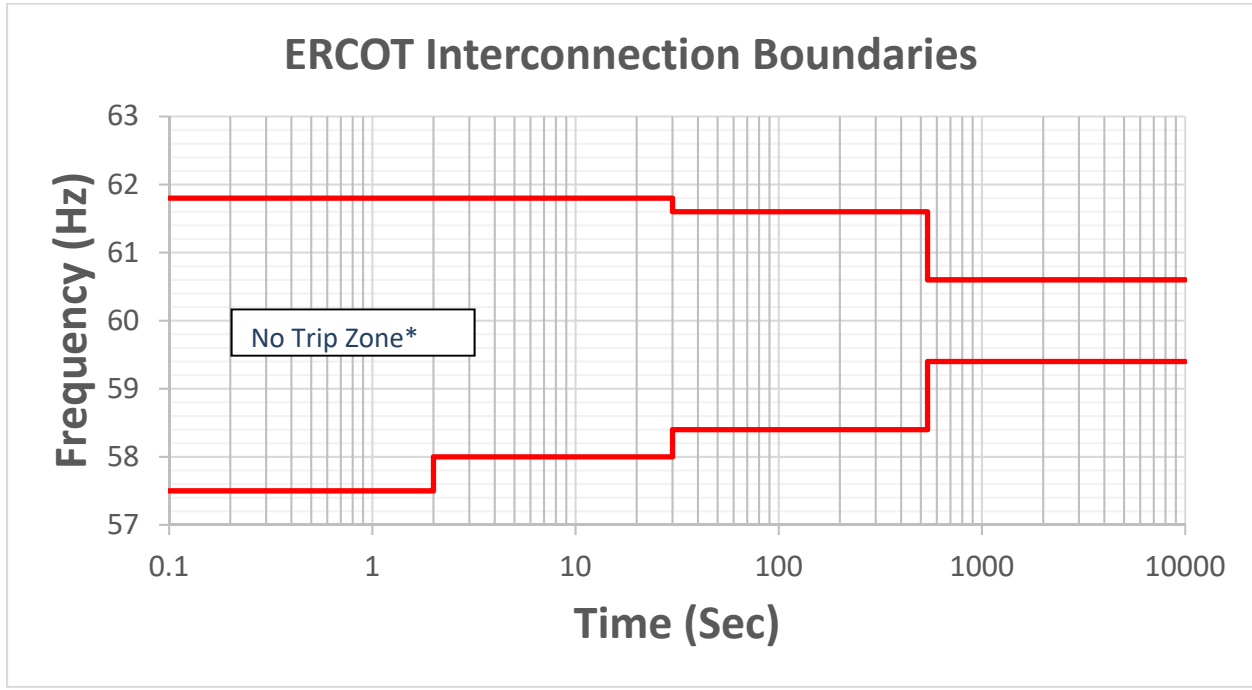

Figure 4

* The area outside the "No Trip Zone" is not a "Must Trip Zone."

Frequency Boundary Data Points – ERCOT Interconnection

High Frequency Duration		Low Frequency Duration	
Frequency (Hz)	Minimum Time (Sec)	Frequency (Hz)	Minimum Time (sec)
≥61.8	Instantaneous ⁹⁹ trip	≤57.5	Instantaneous ⁹⁹ trip
≥61.6	30	≤58.0	2
≥60.6	540	≤58.4	30
<60.6	Continuous operation	≤59.4	540
		>59.4	Continuous operation

Table 4

~~PRC-024 — Attachment 2~~

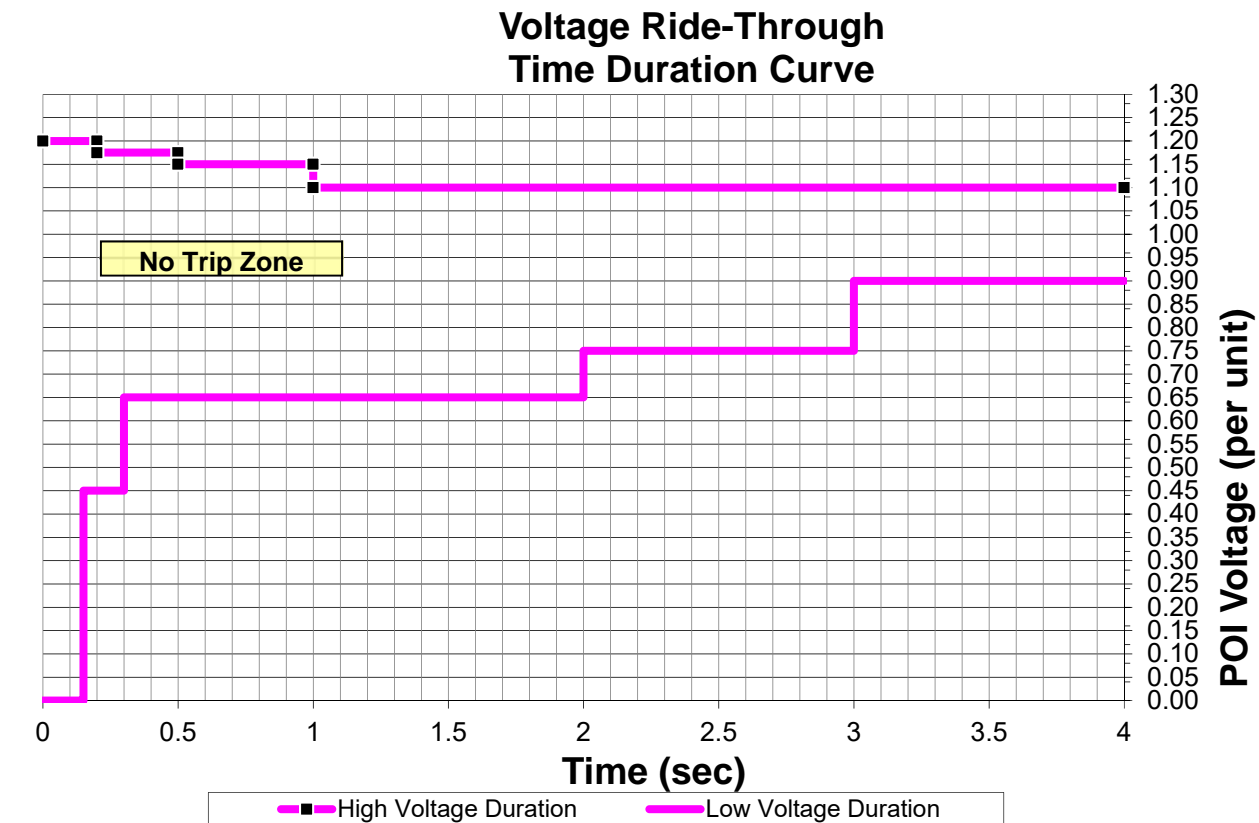

~~Ride Through Duration:~~

PRC-024 — Attachment 2
(Voltage No-Trip Boundaries – Eastern, Western, and ERCOT Interconnections)

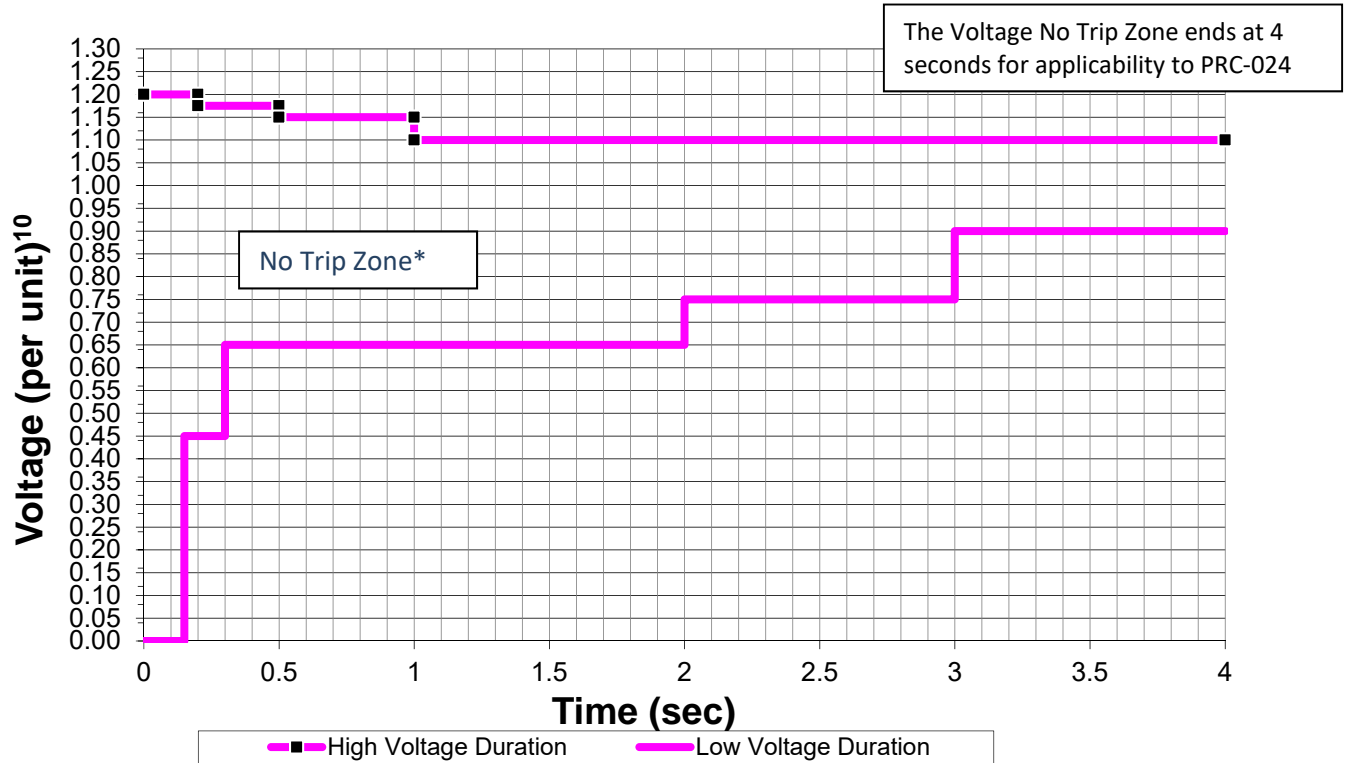

Figure 1

** The area outside the "No Trip Zone" is not a "Must Trip Zone."*

Voltage Boundary Data Points

High Voltage Duration		Low Voltage Duration	
Voltage (pu)	Minimum Time (sec)	Voltage (pu)	Minimum Time (sec)
≥ 1.200	0.00	< 0.45	0.15
≥ 1.175	0.20	< 0.65	0.30
≥ 1.15	0.50	< 0.75	2.00
≥ 1.10	1.00	< 0.90	3.00
< 1.10	4.00	≥ 0.90	4.00

Table 1

¹⁰Voltage at the high-side of the GSU or MPT.

Attachment 2: Voltage Ride-Through Curve Boundary Clarifications — Eastern, Western, and ERCOT Interconnections

Curve

Boundary Details:

- ~~1. The per unit voltage base for these curves is the nominal operating voltage. Unless otherwise specified by the Transmission Planner in the analysis of the reliability of the Interconnected Transmission Systems at the point of interconnection to the Bulk Electric System (BES).~~
- ~~2.1. The curves depicted were derived based on three-phase, the per unit voltage base for these boundaries is the nominal transmission system zone 1 faults with Normal Clearing not exceeding 9 cycles. The curves apply to voltage excursions regardless of the type of initiating event. voltage (e.g., 100 kV, 115 kV, 138 kV, 161 kV, 230 kV, 345 kV, 400 kV, 500 kV, 765 kV, etc.).~~
- ~~3. The envelope within the curves represents the cumulative voltage duration at the point of interconnection with the BES. For example, if the voltage first exceeds 1.15 pu at 0.3 seconds after a fault, does not exceed 1.2 pu voltage, and returns below 1.15 pu at 0.4 seconds, then the cumulative time the voltage is above 1.15 pu voltage is 0.1 seconds and is within the no trip zone of the curve.~~
- ~~2. The curves depicted. The values in the table represent the minimum time durations allowed for specified voltage excursion thresholds.~~
- ~~4.3. When evaluating volts per hertz protection, either assume a system frequency is of 60 Hertz. When evaluating Volts/Hertz protection, you may adjust or the magnitude of the high voltage curve boundary can be adjusted in proportion to deviations of frequency below 60 Hz. Hertz.~~
- ~~5.4. Voltages in the curve boundaries assume minimum RMS fundamental frequency phase-to-ground or phase-to-phase voltage for the low voltage duration curve and the greater of maximum RMS or crest phase to phase voltage for the high voltage duration curve per unit voltage.~~
- ~~5. For applicability to PRC-024, the “no trip zone” ends at 4 seconds.~~

Evaluating Protective Relay Protection Settings:

~~Use either. The voltage values in the Attachment 2 voltage boundaries are voltages at the high side of the GSU/MPT. For generating resources with multiple stages of step up to reach interconnecting voltage, this is the high side of the transformer with a low side below 100kV and a high side 100kV or above. When evaluating protection settings, consider the voltage differences between where the protection is measuring voltage and the high side of the GSU/MPT. A steady state calculation or dynamic simulation may be used.~~

~~If using a steady state calculation or dynamic simulation, use the following assumptions or conditions when evaluating protection settings:~~

- a. The most probable real and reactive loading conditions that are believed to be the most probable for the unit under study to evaluate voltage protection relay setting calculations on the static case for steady state initial conditions:
 - ~~b. All of the units connected to the same transformer are online and operating.~~
 - ~~c. All of the units are at full nameplate real power output.~~
 - ~~d. Power factor is 0.95 lagging (i.e. supplying reactive power to the system) as measured at the generator terminals.~~
 - ~~e. The automatic voltage regulator is in automatic voltage control mode.~~
- b. Evaluate voltage protection relay settings assuming that additional All installed generating plant reactive support equipment (such as (e.g., static VAR VAR compensators, synchronous condensers, or capacitors) equipment is available and operating normally.
- c. Account for the actual tap settings of transformers between the generator terminals and the high side of the GSU/MPT.
- d. For dynamic simulations, the automatic voltage regulator is in automatic voltage control mode with associated limiters in service.

PRC-024— Attachment 2a
(Voltage No-Trip Boundaries – Quebec Interconnection)

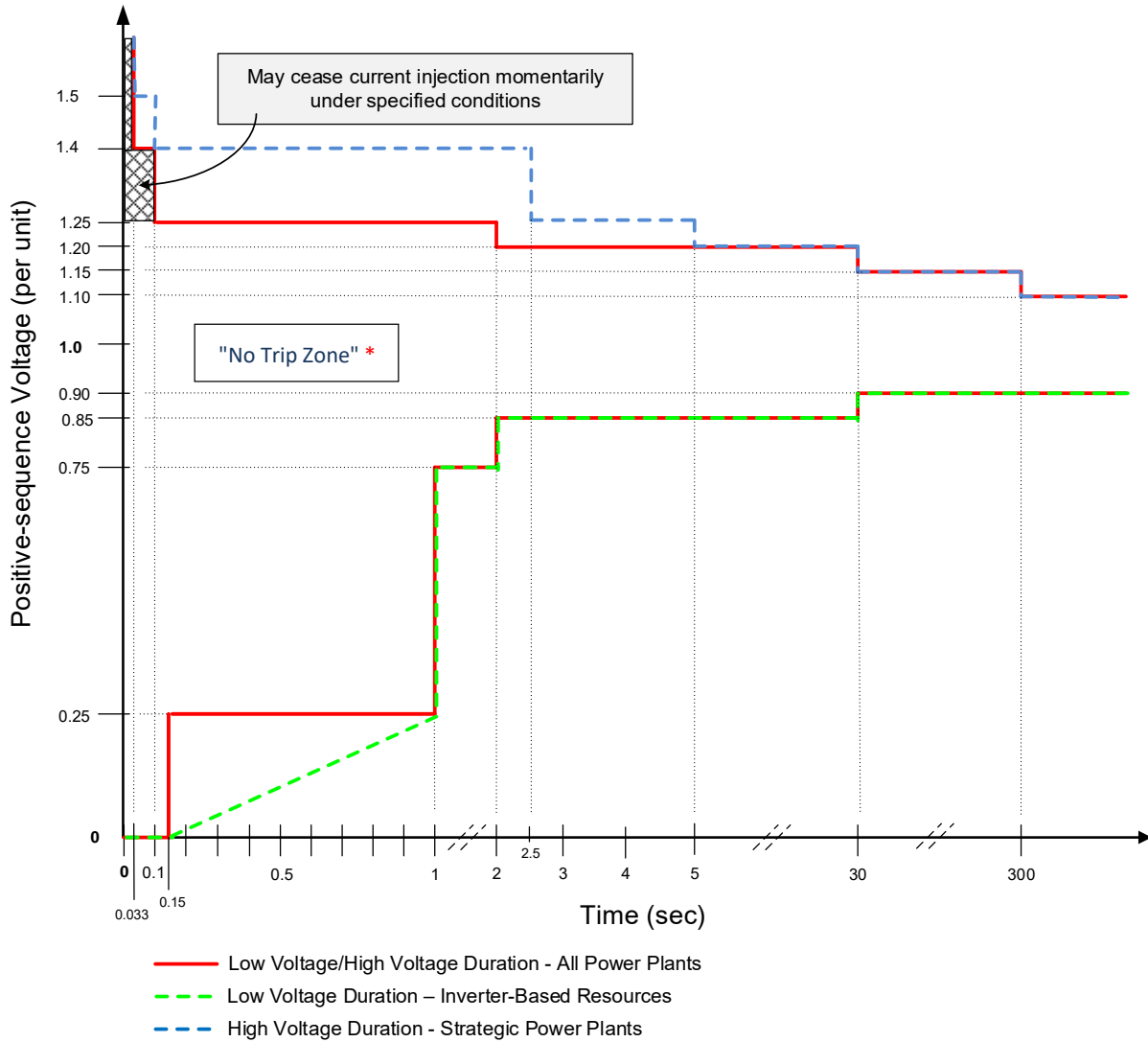

Figure 1

*** The area outside the "No Trip Zone" is not a "Must Trip Zone."**

Voltage Boundary Data Points – Quebec Interconnection

<u>High Voltage Duration for all Power Plants</u>		<u>High Voltage Duration for strategic Power Plants</u>	
<u>Voltage (pu)</u>	<u>Minimum Time (sec)</u>	<u>Voltage (pu)</u>	<u>Minimum Time (sec)</u>
<u>---</u>	<u>---</u>	<u>>1.50</u>	<u>0.033</u>
<u>>1.40</u>	<u>0.033</u>	<u>>1.40</u>	<u>0.10</u>
<u>>1.25</u>	<u>0.10</u>	<u>>1.25</u>	<u>2.50</u>
<u>>1.20</u>	<u>2.00</u>	<u>>1.20</u>	<u>5.00</u>
<u>>1.15</u>	<u>30</u>	<u>>1.15</u>	<u>30</u>
<u>>1.10</u>	<u>300</u>	<u>>1.10</u>	<u>300</u>
<u>≤1.10</u>	<u>continuous</u>	<u>≤1.10</u>	<u>continuous</u>

Table 1

Voltage Boundary Data Points – Quebec Interconnection

<u>Low Voltage Duration for all Power Plants</u>		<u>Low Voltage Duration for Inverter-Based Resources</u>	
<u>Voltage (pu)</u>	<u>Minimum Time (sec)</u>	<u>Voltage (pu)</u>	<u>Minimum Time (sec)</u>
<u><0.25</u>	<u>0.15</u>	<u><0.25</u>	<u>3.4*V(pu)+0.15</u>
<u><0.75</u>	<u>1.00</u>	<u><0.75</u>	<u>1.00</u>
<u><0.85</u>	<u>2.00</u>	<u><0.85</u>	<u>2.00</u>
<u><0.90</u>	<u>30</u>	<u><0.90</u>	<u>30</u>
<u>≥0.90</u>	<u>continuous</u>	<u>≥0.90</u>	<u>continuous</u>

Table 2

Attachment 2a: Voltage Boundary Clarifications – Quebec Interconnection

Boundary Details:

1. The per unit voltage base for these boundaries is the nominal operating voltage (e.g., 120 kV, 161 kV, 230 kV, 315 kV, 735 kV, etc.).
2. The values in the table represent the minimum time durations allowed for specified voltage excursion thresholds.
3. When evaluating volts per hertz protection, either assume a system frequency of 60 Hertz or the magnitude of the high voltage boundary can be adjusted in proportion to deviations of frequency below 60 Hertz.
4. Voltages in the Quebec Interconnection boundaries assume positive-sequence values.

Evaluating Protection Settings:

The voltage values in the Attachment 2a voltage boundaries are voltages at the high side of the GSU/MPT. For generating resources with multiple stages of step up to reach interconnecting voltage, this is the high side of the transformer that connects to the interconnecting voltage. When evaluating protection settings, consider the voltage differences between where the protection is measuring voltage and the high side of the GSU/MPT. A steady state calculation or dynamic simulation may be used.

If using a steady state calculation or dynamic simulation, use the following conditions when evaluating protection settings:

- a. The most probable real and reactive loading conditions for the unit under study.
- b. All installed generating plant reactive support (e.g., static VAR compensators, synchronous condensers, capacitors) equipment is available and operating normally.
- c. Account for the actual tap settings of transformers between the generator terminals and the high side of the GSU/MPT.
- d. For dynamic simulations, the automatic voltage regulator is in automatic voltage control mode with associated limiters in service.

~~During development of this standard, text boxes were embedded within the standard to explain the rationale for various parts of the standard. Upon BOT approval, the text from the rationale text boxes was moved to this section.~~

Rationale for Footnotes 2 and 4

~~Standard Standard-PRC-024-23 — Generator Frequency and Voltage Protective Relay Settings for Generating Resources~~ Generator Frequency and Voltage Protective Relay Settings

~~The SDT has determined it is appropriate to require that protective relay settings applied on both the individual generating units and aggregating equipment (including any non-Bulk Electric System collection system equipment) are set respecting the “no-trip zone” referenced in the requirements to maintain reliability of the BES. If any of the protective relay settings applied on these elements of the facility were to be excluded from this standard, the potential would exist for portions of or the entire generating capacity of the dispersed power producing facility to be lost during a voltage or frequency excursion.~~

Exhibit B
Implementation Plan

Implementation Plan

Project 2018-04 Modifications to PRC-024-2 Reliability Standard PRC-024-3

Applicable Standard

- Reliability Standard PRC-024-3 –Frequency and Voltage Protection Settings for Generating Resources

Requested Retirement

- Reliability Standard PRC-024-2 – Generator Frequency and Voltage Protective Relay Settings

Prerequisite Standard(s)

- None

Applicable Entities

- Generator Owners that apply protection listed in Section 4.2.1.
- Transmission Owners (in the Quebec Interconnection only) that own a BES generator step-up (GSU) transformer or main power transformer (MPT) and apply protection listed in Section 4.2.1.
- Planning Coordinators (in the Quebec Interconnection only)

Background

Reliability Standard PRC-024-3 contains a series of revisions and clarifications intended to help ensure that inverter-based resources respond to grid disturbances in a manner that contributes to the reliable operation of the Bulk-Power System.

The standard was revised to address recommendations of the NERC Inverter-Based Resource Performance Task Force. These recommendations were developed in response to the findings and recommendations of the NERC and WECC analysis of the [Blue Cut Fire](#) and [Canyon 2 Fire](#) disturbances in southern California.

In addition, the standard includes a Regional Variance for the Quebec Interconnection and related revisions to clarify the applicability of the standard in that Interconnection.

General Considerations

This Implementation Plan is intended to provide applicable entities with sufficient time to evaluate settings, make changes for applicable equipment, and purchase necessary equipment, if necessary.

Setting changes and equipment installations are typically completed during generating Facility outages, which may be scheduled in up to twenty-four (24) month intervals.

Effective Date

Reliability Standard PRC-024-3

Where approval by an applicable governmental authority is required, the standard shall become effective on the first day of the first calendar quarter that is twenty-four (24) months after the effective date of the applicable governmental authority's order approving the standard, or as otherwise provided for by the applicable governmental authority.

Where approval by an applicable governmental authority is not required, the standard shall become effective on the first day of the first calendar quarter that is twenty-four (24) months after the date the standard is adopted by the NERC Board of Trustees, or as otherwise provided for in that jurisdiction.

Retirement Date

Reliability Standard PRC-024-2

Reliability Standard PRC-024-2 shall be retired immediately prior to the effective date of Reliability Standard PRC-024-3 in the particular jurisdiction in which the revised standard is becoming effective.

Exhibit D

Analysis of Violation Severity Levels

Violation Risk Factor and Violation Severity Level Justifications

Project 2018-04 Modifications to PRC-024-2 December 2019

This document provides the standard drafting team's (SDT's) justification for assignment of violation risk factors (VRFs) and violation severity levels (VSLs) for each requirement in Reliability Standard PRC-024-3. Each requirement is assigned a VRF and a VSL. These elements support the determination of an initial value range for the Base Penalty Amount regarding violations of requirements in FERC-approved Reliability Standards, as defined in the Electric Reliability Organizations (ERO) Sanction Guidelines. The SDT applied the following NERC criteria and FERC Guidelines when developing the VRFs and VSLs for the requirements.

NERC Criteria for Violation Risk Factors

High Risk Requirement

A requirement that, if violated, could directly cause or contribute to Bulk Electric System instability, separation, or a cascading sequence of failures, or could place the Bulk Electric System at an unacceptable risk of instability, separation, or cascading failures; or, a requirement in a planning time frame that, if violated, could, under emergency, abnormal, or restorative conditions anticipated by the preparations, directly cause or contribute to Bulk Electric System instability, separation, or a cascading sequence of failures, or could place the Bulk Electric System at an unacceptable risk of instability, separation, or cascading failures, or could hinder restoration to a normal condition.

Medium Risk Requirement

A requirement that, if violated, could directly affect the electrical state or the capability of the Bulk Electric System, or the ability to effectively monitor and control the Bulk Electric System. However, violation of a medium risk requirement is unlikely to lead to Bulk Electric System instability, separation, or cascading failures; or, a requirement in a planning time frame that, if violated, could, under emergency, abnormal, or restorative conditions anticipated by the preparations, directly and adversely affect the electrical state or capability of the Bulk Electric System, or the ability to effectively monitor, control, or restore the Bulk Electric System. However, violation of a medium risk requirement is unlikely, under emergency, abnormal, or restoration conditions anticipated by the preparations, to lead to Bulk Electric System instability, separation, or cascading failures, nor to hinder restoration to a normal condition.

Lower Risk Requirement

A requirement that is administrative in nature and a requirement that, if violated, would not be expected to adversely affect the electrical state or capability of the Bulk Electric System, or the ability to effectively monitor and control the Bulk Electric System; or, a requirement that is administrative in nature and a requirement in a planning time frame that, if violated, would not, under the emergency, abnormal, or restorative conditions anticipated by the preparations, be expected to adversely affect the electrical state or capability of the Bulk Electric System, or the ability to effectively monitor, control, or restore the Bulk Electric System.

FERC Guidelines for Violation Risk Factors

Guideline (1) – Consistency with the Conclusions of the Final Blackout Report

FERC seeks to ensure that VRFs assigned to Requirements of Reliability Standards in these identified areas appropriately reflect their historical critical impact on the reliability of the Bulk-Power System. In the VSL Order, FERC listed critical areas (from the Final Blackout Report) where violations could severely affect the reliability of the Bulk-Power System:

- Emergency operations
- Vegetation management
- Operator personnel training
- Protection systems and their coordination
- Operating tools and backup facilities
- Reactive power and voltage control
- System modeling and data exchange
- Communication protocol and facilities
- Requirements to determine equipment ratings
- Synchronized data recorders
- Clearer criteria for operationally critical facilities
- Appropriate use of transmission loading relief.

Guideline (2) – Consistency within a Reliability Standard

FERC expects a rational connection between the sub-Requirement VRF assignments and the main Requirement VRF assignment.

Guideline (3) – Consistency among Reliability Standards

FERC expects the assignment of VRFs corresponding to Requirements that address similar reliability goals in different Reliability Standards would be treated comparably.

Guideline (4) – Consistency with NERC’s Definition of the Violation Risk Factor Level

Guideline (4) was developed to evaluate whether the assignment of a particular VRF level conforms to NERC’s definition of that risk level.

Guideline (5) – Treatment of Requirements that Co-mingle More Than One Obligation

Where a single Requirement co-mingles a higher risk reliability objective and a lesser risk reliability objective, the VRF assignment for such Requirements must not be watered down to reflect the lower risk level associated with the less important objective of the Reliability Standard.

NERC Criteria for Violation Severity Levels

VSLs define the degree to which compliance with a requirement was not achieved. Each requirement must have at least one VSL. While it is preferable to have four VSLs for each requirement, some requirements do not have multiple “degrees” of noncompliant performance and may have only one, two, or three VSLs.

VSLs should be based on NERC’s overarching criteria shown in the table below:

Lower VSL	Moderate VSL	High VSL	Severe VSL
The performance or product measured almost meets the full intent of the requirement.	The performance or product measured meets the majority of the intent of the requirement.	The performance or product measured does not meet the majority of the intent of the requirement, but does meet some of the intent.	The performance or product measured does not substantively meet the intent of the requirement.

FERC Order of Violation Severity Levels

The FERC VSL guidelines are presented below, followed by an analysis of whether the VSLs proposed for each requirement in the standard meet the FERC Guidelines for assessing VSLs:

Guideline (1) – Violation Severity Level Assignments Should Not Have the Unintended Consequence of Lowering the Current Level of Compliance

Compare the VSLs to any prior levels of non-compliance and avoid significant changes that may encourage a lower level of compliance than was required when levels of non-compliance were used.

Guideline (2) – Violation Severity Level Assignments Should Ensure Uniformity and Consistency in the Determination of Penalties

A violation of a “binary” type requirement must be a “Severe” VSL.

Do not use ambiguous terms such as “minor” and “significant” to describe noncompliant performance.

Guideline (3) – Violation Severity Level Assignment Should Be Consistent with the Corresponding Requirement

VSLs should not expand on what is required in the requirement.

Guideline (4) – Violation Severity Level Assignment Should Be Based on a Single Violation, Not on a Cumulative Number of Violations

Unless otherwise stated in the requirement, each instance of non-compliance with a requirement is a separate violation. Section 4 of the Sanction Guidelines states that assessing penalties on a per violation per day basis is the “default” for penalty calculations.

Justification for PRC-024-3 VRFs and VSLs

VRF Justification for PRC-024-3, Requirement R1

The VRF did not change from the previously FERC-approved PRC-024-2 Reliability Standard.

VSL Justification for PRC-024-3, Requirement R1

The SDT only made changes to conform the Requirement R1 VSL to the revised Requirement R1 language. The SDT retained the binary structure of the VSL, which is consistent with both the PRC-024-2 and PRC-024-1 VSLs. As a result, the [justification](#) for the Commission-approved PRC-024-1 Requirement R1 VSL supports the justification for the proposed PRC-024-3, Requirement R1 VSL.

VRF Justification for PRC-024-3, Requirement R2

The VRF did not change from the previously FERC-approved PRC-024-2 Reliability Standard.

VSL Justification for PRC-024-3, Requirement R2

The SDT only made changes to conform the Requirement R2 VSL to the revised Requirement R2 language. The SDT retained the binary structure of the VSL, which is consistent with both the PRC-024-2 and PRC-024-1 VSLs. As a result, the [justification](#) for the Commission-approved PRC-024-1 Requirement R2 VSL supports the justification for the proposed PRC-024-3, Requirement R2 VSL.

VRF Justification for PRC-024-3, Requirement R3

The VRF did not change from the previously FERC-approved PRC-024-2 Reliability Standard.

VSL Justification for PRC-024-3, Requirement R3

The SDT only revised the Requirement R4 VSL to remove the word “generator” to encompass all protection as defined in Section 4.2, Facilities. The SDT retained the existing levels of the VSLs, which is consistent with both the PRC-024-2 and PRC-024-1 VSLs. As a result, the [justification](#) for the Commission-approved PRC-024-1 Requirement R3 VSL supports the justification for the proposed PRC-024-3, Requirement R3 VSL.

VRF Justification for PRC-024-3, Requirement R4

The VRF did not change from the previously FERC-approved PRC-024-2 Reliability Standard.

VSL Justification for PRC-024-3, Requirement R4

The SDT only revised the Requirement R4 VSL to remove the word “generator” to encompass all protection as defined in Section 4.2, Facilities. The SDT retained the existing levels of the VSLs, which is consistent with both the PRC-024-2 and PRC-024-1 VSLs. As a result, the

[justification](#) for the Commission-approved PRC-024-1 Requirement R4 VSL supports the justification for the proposed PRC-024-3, Requirement R4 VSL.

VRF Justification for PRC-024-3, Requirement D.A.2.

The SDT made changes to conform the Requirement D.A.2. VSL to the revised Requirement 2 language with the addition of different no trip voltage boundaries based on power plant type as designated by the Planning Coordinator.

VSL Justification for PRC-024-3, Requirement D.A.2.

The SDT only made changes to conform Requirement D.A.2. with the Requirement R2 VSL as well as to add that newly designated strategic power plants have no less than 48 months to set their protection in accordance with the strategic power plant voltage boundaries in Attachment 2a. The SDT retained the binary structure of the VSL, which is consistent with both the PRC-024-2 and PRC-024-1 VSLs. As a result, the [justification](#) for the Commission-approved PRC-024-1 Requirement R2 VSL supports the justification for the proposed PRC-024-3, Requirement D.A.2. VSL.

VRF Justification for PRC-024-3, Requirement D.A.5.

The VRF for Requirement D.A.5. is Medium, given that is unlikely to lead to Bulk Electric System instability, separation, or cascading failures if violated. This is consistent with Requirements R1, R2, and D.A.2.

VSL Justification for PRC-024-3, Requirement D.A.5.

Proposed VSL's incorporate the increments for tardiness methodology. Proposed VSL language does not include ambiguous terms and ensure uniformity and consistency in the determination of penalties based on timeliness of the action specified. Proposed VSL's are based on a single violation and not a cumulative violation methodology.

Exhibit E

Summary of Development History and Complete Record of Development

Summary of Development History

Summary of Development History

The following is a summary of the development record for proposed Reliability Standard PRC-024-3.

I. Overview of the Standard Drafting Team

Pursuant to Section 215(d)(2) of the Federal Power Act, when evaluating a proposed Reliability Standard, the Commission is expected to give “due weight” to the technical expertise of the ERO.¹ The technical expertise of the ERO is derived from the standard drafting team (“SDT”) selected to lead each project in accordance with Section 4.3 of the NERC Standard Processes Manual.² For this project, the SDT consisted of industry experts, all with a diverse set of experiences. A roster of the Project 2018-04 – Modifications to PRC-024-2 (“Project 2018-04”) included in **Exhibit G**.

II. Standard Development History

A. Standard Authorization Request Development

As further described in **Exhibit E** hereto, NERC initiated a standard development project, Project 2018-04, to address the IRPTF recommendations. The NERC Operating Committee and Planning Committee submitted a Standard Authorization Request (“SAR”) developed by the IRPTF that detailed the scope of Project 2018-04. The SAR was posted for a 30-day formal comment period from December 19, 2018 through January 18, 2019 and was accepted by the Standards Committee on February 20, 2019.

¹ 16 U.S.C. § 824o(d)(2) (2018).

² The NERC *Standard Processes Manual* is available at https://www.nerc.com/FilingsOrders/us/RuleOfProcedureDL/SPM_Clean_Mar2019.pdf.

B. First Posting - Comment Period, Initial Ballot, and Non-binding Poll

Proposed Reliability Standard PRC-024-3, the associated Implementation Plan, Violation Risk Factors (“VRFs”), Violation Severity Levels (“VSLs”), and other associated documents were posted for a 45-day formal comment period from April 17, 2019 through May 31, 2019, with a parallel initial ballot and non-binding poll held during the last 10 days of the comment period from May 22, 2019 through May 31, 2019. The initial ballot of PRC-024-3 did not receive the requisite approval, with affirmative votes of 52.28 percent of the ballot pool and 88.37 percent quorum. The non-binding poll for the associated VRFs and VSLs received 52.48 percent supportive opinions, reaching quorum at 87.68 percent of the ballot pool. There were 69 sets of responses, including comments from approximately 169 different individuals and approximately 125 companies, representing all 10 industry segments.³

C. Supplemental SAR

A supplemental SAR was submitted to address additional potential reliability issues. The supplemental SAR was posted for a 30-day informal comment period from June 27, 2019 through July 26, 2019.

D. Second Posting – Comment Period, Additional Ballot, and Non-binding Poll

Proposed Reliability Standard PRC-024-3, the associated Implementation Plan, VRFs, Violation Severity Levels VSLs, and other associated documents were posted for a 45-day formal comment period from September 20, 2019 through November 4, 2019, with a parallel additional ballot and non-binding poll held during the last 10 days of the comment period from October 25, 2019 through November 4, 2019. The second draft of proposed Reliability Standard

³ NERC, *PRC-024-3 Draft 1 Summary Comment Responses*, Project 2018-04 Modification to PRC-024-2 (2019), https://www.nerc.com/pa/Stand/Project%20201804%20Modifications%20to%20PRC0242/2018-04_PRC-024_Summary_Response_to_Comments_09202019.pdf.

PRC-024-3 received the requisite approval, with affirmative votes of 86.67 percent of the ballot pool and 81.88 percent quorum. The non-binding poll for the associated VRFs and VSLs received 86.46 percent supportive opinions, reaching quorum at 81.14 percent of the ballot pool. There were 49 sets of responses, including comments from approximately 140 different individuals and approximately 106 companies, representing all 10 industry segments.⁴

E. Final Ballot

NERC conducted a ten-day final ballot for proposed Reliability Standard PRC-024-3 from December 4, 2019 through December 13, 2019. The final ballot for proposed PRC-024-3 received affirmative votes of 82.47 percent of the ballot pool and achieved 89.26 percent quorum.

F. Board of Trustees Adoption

The Board of Trustees adopted the proposed Reliability Standard on February 6, 2020.⁵

⁴ NERC, *Consideration of Comments*, Project 2018-04 Modification to PRC-024-2 (2019), https://www.nerc.com/pa/Stand/Project%20201804%20Modifications%20to%20PRC0242/2018-04_PRC-024_Consideration_of_Comments_12042019.pdf.

⁵ NERC, *Board of Trustees Agenda Package*, Agenda Item 7b (PRC-024-2 - Frequency and Voltage Protection Settings for Generating Resources), https://www.nerc.com/gov/bot/Agenda%20highlights%20and%20Mintues%202013/Board_Open_Meeting_Agenda_Package_February_6_2020.pdf.

Complete Record of Development

Home > Program Areas & Departments > Standards > Project 2018-04 Modifications to PRC-024-2
Project 2018-04 Modifications to PRC-024-2

Related Files

Status

The final ballot for **PRC-024-3 – Generator Frequency and Voltage Protection Settings** concluded **8 p.m. Eastern, Friday, December 13, 2019**. The voting results can be accessed via the link below. The standard will be submitted to the Board of Trustees for adoption and then filed with the appropriate regulatory authorities.

Background

On November 27, 2018, the NERC Operating Committee (OC) and Planning Committee (PC) submitted a Standard Authorization Request (SAR) prepared by the Inverter-Based Resource Performance Task Force (IRPTF), which reports to the OC and PC.

Based off the analyses of the [Blue Cut Fire](#) and [Canyon 2 Fire](#) disturbances in southern California along with the development of the [PRC-024-2 Gaps Whitepaper](#), the IRPTF identified potential modifications to PRC-024-2 to ensure that inverter-based generator owners, operators, developers, and equipment manufacturers understand the intent of the standard in order for their plants to respond to grid disturbances in a manner that contributes to the reliable operation of the BPS.

The standard drafting team developed the proposed modifications in PRC-024-3 to address the issues in the [SAR](#).

Standard(s) Affected – [PRC-024-2](#)

Draft	Actions	Dates	Results	Consideration of Comments
<p>Final Draft</p> <p>PRC-024-3 (Updated)</p> <p>Clean (44) Redline to Last Posted (45) Redline to Last Approved (46)</p> <p>Implementation Plan (47)</p> <p>Supporting Materials</p> <p>VRF/VSL Justifications (48)</p>	<p>Final Ballot</p> <p>Info (49)</p> <p>Vote</p>	<p>12/04/19 – 12/13/19</p>	<p>Ballot Results(50)</p>	
<p>Draft 2</p> <p>PRC-024-3</p> <p>Clean (29) Redline to Last Posted (30)</p> <p>Implementation Plan</p> <p>Clean (31) Redline to Last Posted (32)</p> <p>Supporting Materials</p> <p>Unofficial Comment Form (Word) (33)</p> <p>VRF/VSL Justifications</p> <p>Clean (34) Redline to Last Posted (35)</p>	<p>Additional Ballot and Non-binding Poll</p> <p>Updated Info (37)</p> <p>Info (38)</p> <p>Vote</p>	<p>10/25/19 - 11/04/19</p>	<p>Ballot Results (39)</p> <p>Non-binding Poll Results (40)</p>	<p>Consideration of Comments (43)</p>
	<p>Comment Period</p> <p>Info (41)</p> <p>Submit Comments</p>	<p>09/20/19 - 11/04/19</p>	<p>Comments Received (42)</p>	

Draft Reliability Standard Audit Worksheet (36)				
<p>Supplemental Standard Authorization Request (25)</p> <p>Supporting Materials</p> <p>Unofficial Comment Form (Word) (26)</p>	<p>Comment Period</p> <p>Info (27)</p> <p>Submit Comments</p>	<p>06/27/19 - 07/26/19</p>	<p>Comments Received (28)</p>	
<p>Draft 1</p> <p>PRC-024-3</p> <p>Clean (11) Redline to Last Approved (12)</p> <p>Implementation Plan (13)</p> <p>Supporting Materials</p> <p>Unofficial Comment Form (Word) (14)</p> <p>VRF/VSL Justification (15)</p> <p>Summary of Key Changes (16)</p> <p>Draft Reliability Standard Audit Worksheet (RSAW) (17)</p>	<p>Initial Ballot and Non-binding Poll</p> <p>Updated Info (18)</p> <p>Info (19)</p> <p>Vote</p>	<p>05/22/19 - 05/31/19</p>	<p>Ballot Results (20)</p> <p>Non-binding Poll Results (21)</p>	
	<p>Comment Period</p> <p>Info (22)</p> <p>Submit Comments</p>	<p>04/17/19 - 05/31/19</p>	<p>Comments Received (23)</p>	<p>Consideration of Comments (24)</p>
	<p>Join Ballot Pools</p>	<p>04/17/19 - 05/16/19</p>		
	<p>Send RSAW feedback to: RSAWfeedback@nerc.net</p>			
<p>Standard Authorization Request (SAR)</p> <p>Clean (9) Redline (10)</p>	<p>The Standards Committee Accepted the SAR on February 20, 2019</p>			
<p>Drafting Team Nominations</p> <p>Supporting Materials</p>	<p>Nomination Period</p> <p>Info (8)</p>			

<p>Unofficial Nomination Form (Word) Updated (7)</p>	<p>Submit Nominations</p>	<p>12/19/18 - 01/18/19</p>		
<p>Standard Authorization Request (3)</p> <p>Supporting Materials</p> <p>Unofficial Comment Form (Word) Updated (2)</p> <p>PRC-024-2 Gaps Whitepaper (1)</p>	<p>Comment Period</p> <p>Info (4)</p> <p>Submit Comments</p>	<p>12/19/18 – 01/18/19</p>	<p>Comments Received (5)</p>	<p>Response to Comments (6)</p>

PRC-024-2 Gaps Whitepaper

NERC Inverter-Based Resource Performance Task Force (IRPTF)

Purpose

The NERC Inverter-Based Resource Performance Task Force (IRPTF)¹ scope document² includes a deliverable on “recommendations on inverter-based resource performance and any modifications to NERC Reliability Standards related to the control and dynamic performance of these resources during abnormal grid conditions.” The whitepaper presented here details the findings of the IRPTF as a result of investigations related to this deliverable. Specifically, the whitepaper details potential gaps and needed clarifications in PRC-024-2: *Generator Frequency and Voltage Protective Relay Settings*.³ There is some overlap between the findings of this whitepaper and the Integration of Variable Generation Task Force (IVGTF) Summary and Recommendations of 12 Tasks⁴ which was published in 2015.

Background

Multiple grid disturbances in the Western Interconnection have highlighted the potential risk of fault-induced solar photovoltaic (PV) tripping. While these disturbances have been prominent in the West, the underlying issues are systemic in the solar PV fleet across interconnections.

- On August 16, 2016, the Blue Cut Fire disturbance resulted in approximately 1200 MW of solar photovoltaic (PV) resources tripping offline or momentarily ceasing output in Southern California. NERC and WECC created an ad hoc task force to investigate causes of the solar PV tripping, develop a disturbance report⁵, initiate remedial actions, and provide recommendations for future work.
- On October 9, 2017, the Canyon 2 Fire disturbance in Southern California resulted in approximately 900 MW of solar PV tripping or momentarily ceasing output. This disturbance involved voltage-related tripping, and highlighted an unintended interpretation of PRC-024-2. NERC and WECC developed a disturbance report⁶, which included key findings and recommendations for mitigating action.

¹ NERC Inverter-Based Resource Performance Task Force (IRPTF) webpage. Available: <https://www.nerc.com/comm/PC/Pages/Inverter-Based-Resource-Performance-Task-Force.aspx>.

² IRPTF Scope Document. Available:

https://www.nerc.com/comm/PC/InverterBased%20Resource%20Performance%20Task%20Force%20IRPT/IRPTF_Scope_20170619.pdf.

³ NERC Reliability Standard PRC-024-2 – Generator Frequency and Voltage Protective Relay Settings. Available:

https://www.nerc.com/layouts/15/PrintStandard.aspx?standardnumber=PRC-024-2&title=Generator%20Frequency%20and%20Voltage%20Protective%20Relay%20Settings&jurisdiction=United_States.

⁴ IVGTF Report. Available:

https://www.nerc.com/comm/PC/Integration%20of%20Variable%20Generation%20Task%20Force%20I1/IVGTF%20Summary%20and%20Recommendation%20Report_Final.pdf

⁵ Blue Cut Fire Disturbance Report. Available:

http://www.nerc.com/pa/rrm/ea/1200_MW_Fault_Induced_Solar_Photovoltaic_Resource_/1200_MW_Fault_Induced_Solar_Photovoltaic_Resource_Interruption_Final.pdf.

⁶ Canyon 2 Fire Disturbance Report. Available:

<https://www.nerc.com/pa/rrm/ea/Pages/October-9-2017-Canyon-2-Fire-Disturbance-Report.aspx>.

Both disturbance reports have led to NERC Alerts to gather necessary data to understand the extent of the conditions identified as well as to recommend mitigating actions to these potential reliability risks to the Bulk Electric System (BES). Following completion of the Blue Cut Fire disturbance analysis, NERC formed the NERC IRPTF to continue focusing on inverter-based resource performance during steady-state

PRC-024-2 Issues

FERC approved the NERC Reliability Standard PRC-024-2: *Generator Frequency and Voltage Protective Relay Settings* in May 2015 and the standard went into effect on July 1, 2016. The original version of the standard, PRC-024-1, was approved by FERC in 2014. The purpose of PRC-024-2 is to “ensure Generator Owners set their generator protective relays such that generating units remain connected during defined frequency and voltage excursions.” The primary purpose of the revision was not to ensure the protection of generation resources, but rather to aid BES stability without jeopardizing the generation resources. Hence, the standard includes requirements that generator protective relays be set such that they do not trip the applicable generating unit(s) when operating within specified frequency and voltage “no trip” zones.

Event analysis for both the Blue Cut Fire and Canyon 2 Fire disturbances revealed that misinterpretation of the requirements of PRC-024-2 led to the intentional and unnecessary tripping of solar PV resources during these events. In addition to identifying the need to provide clarity around the intent and requirements in PRC-024-2, the IRPTF also found errors within the standard. Based on these findings, the IRPTF has concluded that the following issues in PRC-024- 2 should be addressed:

- The standard is often interpreted and applied as a “ride-through standard”, whereas it is fundamentally intended and approved to be a voltage and frequency protective settings standard. This white paper minimizes the use of the term “ride-through” and recommends eliminating its use in PRC-024-2 entirely to add clarity.⁷
- The region outside the “No-Trip” zone of the PRC-024-2 curves should be clearly marked as a “May-Trip” zone so it is not interpreted as a “Must-Trip” zone. The preferred behavior is for the generators to remain connected and producing current during disturbances to the greatest extent possible.
- There is inconsistency between the Curve Data Point tables and the Off Nominal Frequency Capability Curves as the table identifies “instantaneous” trip points while the time axis of the curve starts at 100 ms.
- There is confusion in point #5 of the Curve Details section of the Voltage Curve Clarifications regarding crest and RMS voltage relationship. There is also confusion regarding why the high voltage curve uses phase-to-phase voltage only but the low voltage curve uses phase-to-phase or phase-to-ground (this may be inconsistent with inverter-based resource protection practices). There is also confusion on the use of instantaneous tripping, particularly since inverter protection

⁷ A “ride through standard” would include more definitive requirements as to how the resource should behave within the “ride through” zones, including controls performance and protection aspects. This would involve changing the purpose, scope, and intent of the standard. Therefore, the IRPTF is not providing recommendations on this topic at this time. However, the IRPTF will explore this concept in early 2019. See the *Other Issues for Consideration and IRPTF Next Steps* section of this document.

may be much faster than conventional relaying, which perform filtering on the incoming waveform.

- There is confusion regarding the inclusion of the four second cumulative timer functionality, as well as when the timer starts, stops, and resets.
- There is confusion regarding footnote 1 and the applicability of inverter protective functions within the inverter control systems.
- There is confusion as to the use of momentary cessation within the “No Trip” zone of PRC-024-2.

“Ride-Through” Standard vs. Protection Settings Standard

PRC-024-2 is often interpreted, or used by local utilities, as a “ride-through standard”, meaning that the entire plant is expected ride through a disturbance within the PRC-024-2 curves. However, the standard requirements are specific in applying solely to the voltage and frequency protective settings and not to the overall plant. For example, a synchronous generating facility may trip on loss of synchronism, loss of auxiliary loads that could trip the turbine, or other forms of protection. As long as the resource has its voltage and frequency protective relaying set correctly, the resource is compliant with the standard. Similarly, for inverter-based resources, it is expected that a resource that trips on any DC bus protection, phase lock loop loss of synchronism, or other forms of inverter protection would also be compliant with the standard requirements so long as the voltage and frequency protective relaying is set according to the standard requirements. The IRPTF recommends a clear differentiation between “ride-through” and the PRC-024-2 protective relaying standard to bring clarity to requirements and applicability of the standard. IRPTF also recommends not using the term “ride-through” anywhere in the standard to avoid the confusion that has arisen.

A number of IRPTF members have stated that PRC-024-2 is being applied as a “ride-through standard” by local utility requirements for inverter-based resources in the absence of other NERC Standards requirements. A number of IRPTF members also generally agree that more comprehensive requirements for inverter-based resources should be explored including, but not limited to, details regarding resource behavior within the “ride-through” zones for both controls and protection aspects. Neither PRC-024-2 nor any other NERC Reliability Standards specify or provide acceptable bounds of performance within the “No-Trip” zone. Unlike synchronous machines, whose electrical response to fault events is predominantly driven by physics, an inverter-based responses to grid events entirely driven by controls.

The IRPTF will develop guidance on this topic immediately following completion of this white paper, and will bring any recommendations and potential SARs to the NERC Planning and Operating Committees, as necessary. Topics to be explored include, but are not limited to, type of current injection for different grid events, response to both unbalanced and balanced faults, response within the first 100 ms of a frequency excursion, and response to other transient conditions. The IRPTF will also explore other forms of protection not covered by PRC-024-2, including but not limited to, phase lock loop loss of synchronism, DC bus protection, and inverter current protection. These forms of tripping are not covered in PRC-024-2, are not particularly relevant for synchronous machines, yet are very relevant to inverter-based resource protection and performance during grid disturbances.

“Must-Trip” versus “May-Trip” Interpretation

PRC-024-2 specifies a “No-Trip” area for voltage and frequency excursions, as measured at the point of interconnection to the BES. According to the Blue Cut Fire Disturbance Analysis Report solar development owners and inverter manufacturers have misinterpreted the area outside of the “No-Trip” curve as a “Must-Trip” requirement. This is possibly due to the use of the term “instantaneous trip” in the tables following the voltage and frequency curves.

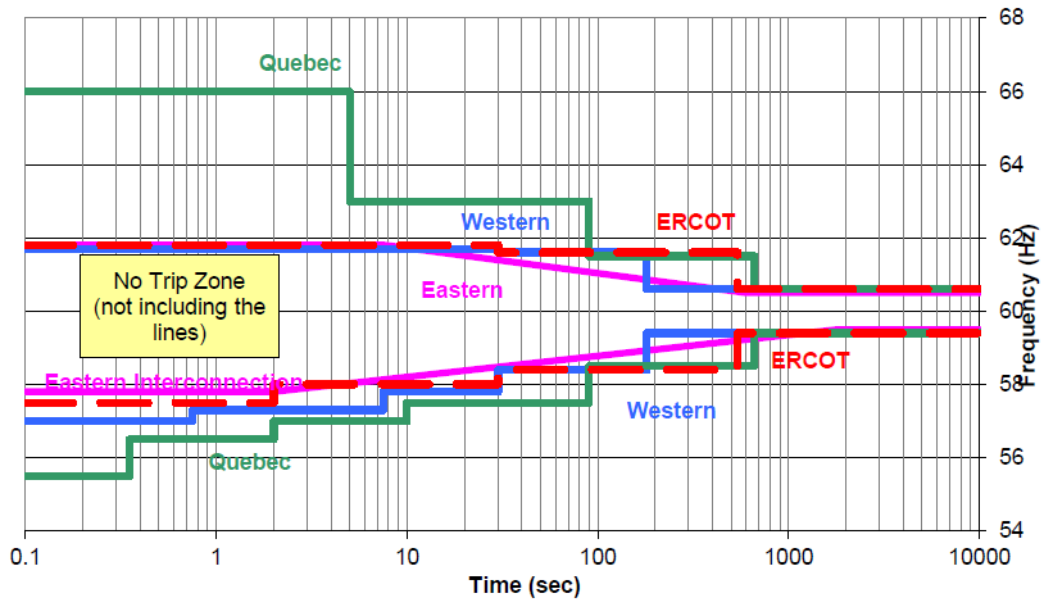

Figure 1: PRC-024-2 Frequency Curve

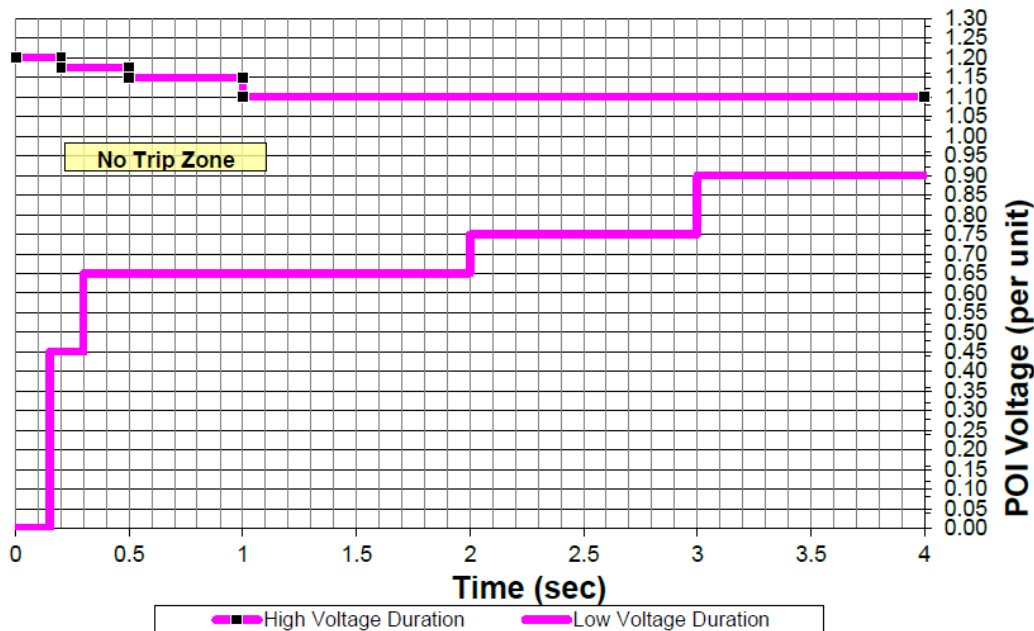

Figure 2: PRC-024-2 Voltage Curve

PRC-024-2 footnote 1 clarifies that Generator Owners are not required to have frequency or voltage protective relays. However, most inverter control systems have built-in protective controls for which the Generator Owners must provide settings. The Canyon 2 Fire Disturbance Report⁸ found that all of the owners and manufacturers of the affected inverters had used the PRC-024-2 voltage curve to set the voltage protective settings. Several of the data request responses indicated that the “May- Trip” zone was being interpreted as a “Must-Trip” zone. Hence, despite the recognition in the Blue Cut Fire Disturbance Analysis Report of this misinterpretation, the industry was still setting the voltage protective settings according to the standard curve rather than on actual equipment voltage limitations, approximately 14 months after the Blue Cut Fire Event. Further, these set points were incorrectly applied at the inverter terminals, which are subject to wider voltage excursions than at the point of interconnection during transmission system disturbances due to voltage drop or rise across the collection system during the disturbance. The filters, capacitors, or cables in the collection system may augment the transient electrical disturbance that originated in the transmission system.

However, the intent of the PRC-024-2 voltage requirement is to define the minimum and maximum voltage conditions where generating resources may trip from protective relaying for voltage excursions. The region outside the “No-Trip” zone should be interpreted as a “May-Trip” zone and not a “Must-Trip” zone. Inverter settings should be determined based on equipment limitations and should be set to the greatest extent possible. This helps support bulk power system (BPS) reliability during and following grid events such as faults.

Similarly, frequency trip settings for generation resources should be set as wide as possible while still ensuring equipment protection and personnel safety to support BPS reliability. This aligns with the intent of PRC- 024-2. One possible solution could be to change the requirement such that relay settings be set based on equipment limitations but no narrower than the “No-Trip” zones.

Inconsistency between Curves and Tables

PRC-024-2 Attachments 1 and 2 include graphics showing the off-nominal frequency capability curve and the voltage curve, respectively, with curve data point tables describing the curves in tabular form. The curves and tables define the frequency and voltage protective relay setting minimum performance requirements. Each table contains a value for which a generation resource is allowed to instantaneously trip, essentially describing at what frequency or voltage a generator is no longer required to stay connected to the system.

The task force that analyzed the Blue Cut Fire event found that, “[a] significant amount of solar PV resources disconnected due to a perceived system frequency below 57 Hz. This perceived frequency was due to the Phase Locked Loop logic indicating a near instantaneous frequency during the transient/distorted waveform period as less than 57 Hz. The solar development owner and inverter manufacturer interpreted outside of the PRC-024-2 no- trip curve area as a must-trip area. The frequency table in PRC-024-2 for the Western Interconnection indicates instantaneous trip for frequency equal to or

⁸ Canyon 2 Fire Disturbance Report. Available:
<https://www.nerc.com/pa/rrm/ea/Pages/October-9-2017-Canyon-2-Fire-Disturbance-Report.aspx>.

less than 57 Hz. Therefore, the inverters were set to trip instantaneously upon seeing a frequency of 57 Hz.”

However, in generation resource control systems, frequency is calculated over a window of time. Instantaneously derived frequency should not be used for protection. Frequency calculation methods use various types of time windows and filtering methods in order to accurately calculate grid frequency. Typically, these methods use a sliding window with a window width on the order of 100 ms (6 cycles). Thus, a delay would occur even if the protective relay algorithm had no intentional time delay. This measurement interval should be reflected in the standard.

Further, the Off Nominal Frequency Capability Curve of PRC-024-2 is a logarithmic graph that starts at time $t=0.1$ seconds. Thus, the Curve Data Point table “Instantaneous trip” value is inconsistent with the graphic.

Voltage Curve Clarification Error

Point #5 in the Curve Details section of the “Voltage Curve Clarifications” of PRC-024-2 states, “voltages in the curve assume minimum fundamental frequency phase to ground or phase to phase voltage for the low duration curve and the greater of maximum RMS (Root Mean Square) or crest phase to phase voltage for the high voltage duration curve.”

Any voltage measured and compared with the PRC-024-2 voltage ride-through curve should be a well-filtered, fundamental frequency component of the voltage waveform. This filters out spurious voltage spikes caused by switching actions on the BPS. Voltage protective relays should not operate at the voltage levels specified in the voltage curve (e.g., 1.2 pu) using instantaneously sampled values, although it is reasonable for a generator resource to trip for instantaneous voltage spikes above equipment limitations if they can be properly detected. The other issue with this clarification is that the overvoltage component of the clarification states “the greater of maximum RMS or crest phase-to-phase voltage”. There is ambiguity and technical concern on how this is applied, and should be clarified.

Further, PRC-024-2 clarifies that the low voltage duration curve is based on either phase-to-ground or phase-to-phase voltage, the high voltage duration curve is only based on phase-to-phase voltage. It is not clear why phase-to-ground voltage should not also be considered for the high voltage curve. Without addressing these, there may be reliability issues, as identified in the Canyon 2 Fire Disturbance Analysis Report.

Confusion in Cumulative Timer Start and Stop Time

The PRC-024-2 voltage curve ends at four seconds, and the curve uses a cumulative time duration for the “No-Trip” zone. Protective relays must be set to accommodate the cumulative nature of curves. Under the current version of PRC-024-2, it is not clear at what points the cumulative values reset or what are the starting and ending criteria. This cumulative aspect is also applied in the Volts/Hertz relay protection that covers both synchronous generation resources and generator step up transformers and needs to have clarification for the action to trip or reset.

Footnote 1 Applicability Confusion

Footnote 1 is intended to clarify that Generator Owners are not required to have frequency or voltage protective relaying, thus the requirements only apply if they do have such relays. The footnote contains a parenthetical with an “including but not limited to” statement that is intended to further clarify and provide examples of the types of relays that are applicable. The list contained within the parenthetical includes “protective functions within control systems that directly trip or provide tripping signals to the generator resource based on frequency or voltage inputs.”

As noted in the Blue Cut Fire disturbance report, “PRC-024-2 uses language that is more common for conventional synchronous rotating ac generators with traditional protective relays.” Because of the language in the bulk of the standard, there is confusion regarding whether the parenthetical list in the footnote is intended to make inverter controls applicable to the requirements of the standard, and if so, what operating modes or functions are considered “tripping” the generating resource. For example, is the use of momentary cessation in inverter controls considered tripping and, therefore, unacceptable? Further, if PRC-024-2 applies to inverter controls, do the requirements apply to individual inverters or to the generation resource as a whole? As an example, if 50% of inverters within a generation resource trip for a grid disturbance within the “No Trip” zone of the curves, but the generation resource does not trip at a plant level, does that meet the intent of the requirements? These points of confusion should be addressed.

Momentary Cessation

The use of momentary cessation was not considered nor defined in the development of PRC-024-2. Therefore, it was previously unclear as to whether the use of momentary cessation within the “No Trip” zone of PRC-024-2 curves was acceptable. However, IRPTF simulations and studies show that widespread use of momentary cessation within the “No Trip” zone of PRC-024-2 can have a detrimental effect to grid stability, particularly if incorrectly used. From an overall BPS perspective, the nearly instantaneous loss of current injection (and consequently power injection) into the BPS has similar effects as resource tripping. This is particularly true if a significant delay or long ramping period is used prior to the plant recovering its active current output. Therefore, momentary cessation often gets equated to tripping, since from the system-side these look very similar. However, inverters include protective functions that, for example, open the AC circuit breaker. Yet they also have a vast amount of controls that determine the current injection of the resource. Due to the negative impacts of momentary cessation controls, the IRPTF recommends that the use of momentary cessation within the “No Trip” zone of PRC-024-2 should be eliminated (or at least minimized) to the extent possible. Some cases may exist where momentary cessation is used briefly (e.g., during severe fault conditions) for the purpose of improving inverter controls response.

A future Standard Draft Team should closely consider, and possibly consult with the IRPTF, on use of momentary cessation for very low voltages (i.e., less than or equal to, say, 0.3 pu) within the “No Trip” zone of PRC-024-2. At these very low voltages, inverters may have trouble tracking electrical quantities, which is required for reliable current injection into the BPS. The IRPTF will continue exploring this concept, and possibly develop a position on this subject. The position will be based on studies, which will serve as the technical basis for such decision.

Brief Discussion of Terms Used

The IRPTF suggests the following clarifications, as described more thoroughly in the *Reliability Guideline: BPS-Connected Inverter-Based Resource Performance*:

- **Ride-Through Capability:** The capability of generating facilities to remain connected to the BES during grid disturbances involving voltage and/or frequency excursion away from a nominal operating range. As it relates to inverter-based resources, this includes capability to continue injecting current (both active and reactive, as necessary), consideration of momentary cessation, and minimum voltage and frequency capability range.
- **Momentary Cessation:** A mode of operation in which no current is injected into the grid by the inverter during low or high voltage conditions outside the continuous operating range. The power electronic firing commands are blocked, and the inverter does not produce active or reactive current (and therefore no active or reactive power).⁹
 - Momentary cessation is often used outside of the PRC-024-2 curves, particularly for extreme sub-cycle overvoltage conditions at the inverter terminals. These periods are brief, and momentary cessation is often used as a form of self-protection in those instances.
 - Momentary cessation inside of the PRC-024-2 curves is not recommended, and should be eliminated to the extent possible. This has conventionally been used as an operating mode during disturbance events. However, the current recommendation is to continue injection of active and reactive current based on the recommended performance specifications outlined in the *Reliability Guideline: BPS-Connected Inverter-Based Resource Performance*.
- **Recovery from Momentary Cessation:** After momentary cessation occurs within an inverter, the inverter is programmed to return to current injection to reach a new operating state. The recovery typically may involve some type of delay and active current ramp rate upon recovery. The recovery of momentary cessation should be differentiated from the initiating act of entering momentary cessation.
- **Inverter Protective Functions:** All inverters include some protective functions within their controls systems. Inverter tripping for abnormal system frequency and voltages are included in virtually all inverters available today. The set points for these protective functions are often configurable and may be specified by the Generator Owner. This capability is essentially the same as that provided by discrete voltage and frequency relays.
- **Controls:** The protective functions within an inverter should be differentiated from the controls that determine the current injection of the inverter-based resource. PRC-024-2 pertains specifically to the protective aspects of resources, and does not specify controls aspects. However, the IRPTF believes

⁹ IEEE Std. 1547-2018 includes the following definition for momentary cessation: “Temporarily cease to energize an EPS, while connected to the Area EPS, in response to a disturbance of the applicable voltages or the system frequency, with the capability of immediate Restore Output of operation when the applicable voltages and the system frequency return to within defined ranges.”

that momentary cessation (a control function) should be disallowed within the “No Trip” zone of PRC-024-2 due to its negative impact on the BPS.

Other Issues for Consideration and IRPTF Next Steps

The IRPTF has identified additional issues that are considered outside the scope of the above-described topics that specifically pertain to PRC-024-2. However, the IRPTF will be discussing these issues in more detail and may recommend further work or additional revisions to NERC Reliability Standards after the IRPTF has had more time to discuss each issue in detail.

#	Issue
1	<p>A clear differentiation between “ride-through” and the PRC-024-2 protective relaying standard is needed to bring clarity to requirements and applicability of the standard. A number of IRPTF members have expressed a need for a full “ride-through standard” for inverter-based resources, with clear requirements as to how the resource can behavior within the “ride-through” zones. This includes both controls and protection aspects.</p> <p>Inverter-based resource vendors are working to meet local ride-through criteria apart from PRC-024-2, and future NERC standards could definitely provide clarity on these issues. Similarly, a performance-based standard could be developed rather than a protective relay settings standard.</p>
2	<p>Power electronic equipment within an inverter may be equipped with self-protection that may disconnect the switching devices for instantaneous (or sub-cycle) measurement spikes once critical thresholds have been reached to protect equipment integrity. Such instantaneous spikes may be filtered in a RMS signal; therefore, comparison of sub-cycle measurements against a RMS profile (particularly for overvoltage) is problematic. In these cases, the resources may be prone to tripping on sub-cycle spikes in voltage while the RMS signal is within the curve profile.</p> <p>This needs to be clarified in future revisions to PRC-024-2 or other future standards related to ride-through performance. The RMS criteria can only be applicable in the case of RMS simulations or comparison to RMS waveforms. If this RMS criteria is used to evaluate 3 phase signals coming from EMT software simulations or from real measurements, the trip due to an instantaneous overvoltage needs to be taken into account. An instantaneous single-phase limit could also be established. A similar argument can also be made for frequency; however, this is less of a concern based on practical event analysis. Simulations mechanisms for comparing performance versus requirements can also be considered.</p>
3	<p>There are many other forms of inverter protection that can trip an inverter off-line during a disturbance. A number of these protections have been observed in analyses during the Blue Cut Fire and Canyon 2 Fire disturbances. These include, but are not limited to, phase lock loop loss of synchronism, DC bus protection, and inverter current protection. These forms of tripping are not covered in PRC-024-2, yet are highly relevant to the performance and overall ride-through capability of inverter-based resources. These transient-based forms of protection are not particularly relevant for synchronous machines; however, are very relevant to inverter-based resource protection and performance during grid disturbances. Not considering these types of protection could degrade overall system reliability.</p>

#	Issue
4	<p>During a transient grid event, the voltage at the Point of Interconnection is a function of both the characteristics of the transmission system and the behavior (current flow) of the interconnected generation resource. PRC-024-2 does not differentiate responsibilities between these two parties, and strictly applies to ensuring setting voltage and frequency protective relaying such that the resource will not trip on these protective functions for specified Point of Interconnection conditions. However, if the protective relaying philosophy of PRC-024-2 is incorrectly applied or misinterpreted for local studies or requirements, this can lead to issues meeting more rigorous “ride-through” requirements that could be based on PRC-024-2. This should be further explored and corrected, to the extent possible.</p>
5	<p>Instantaneous tripping on frequency measurements was a contributing factor for recent BPS disturbances involving solar PV plants. However, the frequency protection settings of those generators were set incorrectly. Actual frequency ride-through capability of inverter-based resources is such that no instantaneous frequency-related protective actions should be allowed. While synchronous machines have different operating characteristics that expose them to loss of life issues, inverter-based resources do not have these same types of issues.</p>
6	<p>PRC-024-2, nor any NERC Reliability Standard, specifies the performance of resources within the “No-Trip” zone when connected to the BES. Unlike synchronous machines, whose electrical response to fault events is predominantly driven by Newtonian laws of physics, an inverter-based resource’s response to grid events is driven entirely by controls. Upon disallowing momentary cessation within the “No Trip” zone of the PRC-024-2 curves, it is necessary to provide guidance and possibly specification of the type of current injection desired for different grid events. This is important for both unbalanced and balanced faults.</p> <p>This is outside the scope of PRC-024-2, but is considered by many to be of critical importance for maintaining grid stability and reliability at higher penetrations of inverter-based resources. The IRPTF will continue discussions as to the appropriate venues for providing this guidance or requirement.</p>
7	<p>Momentary cessation has been used to handle certain disturbance events where the resource would otherwise be unable to reliably track the grid and be unable to ascertain the correct electrical response. For example, momentary loss of phase lock loop synchronism, DC overvoltage due to a transient high AC system voltage upon fault clearing, and other DC bus dynamics. The existing standard is silent on these issues; however, these types of issues are critical to overall ride-through of inverter-based resources. The IRPTF will consider whether the scope of “ride-through” should be expanded based on these issues.</p>
8	<p>PRC-024-2 does not specify recovery requirements should the plant, or part of the plant, trip or momentarily cease injection of current. Inverter-based resources, being dispersed power producing resources, are subject to partial tripping or partial use of momentary cessation. The standards were not designed with this in mind, and it is unclear if this performance is acceptable.</p>
9	<p>There should be clarification of how inverter-based resources are expected to respond upon the first 100 ms of a disturbance, particularly for frequency excursions.</p>
10	<p>Consideration needs to be given to the operating conditions that are expected to be encountered by inverter-based resources, and ensure that proper studies are performed to identify issues such as ride-through behavior, partial or full plant tripping, and other issues. This includes further consideration for electromagnetic transient (EMT) simulations to identify any phase-based issues rather than strictly positive sequence RMS issues.</p>

#	Issue
11	Tripping of resources may occur if transient or non-fundamental harmonic content occurs in the bulk grid that exceeds 1.2 pu. These conditions may be natural components of the bulk system response, but cannot be correctly simulated using 60 Hz phasor modeling tools, and may require several seconds to damp following severe events. The topic of harmonics, “ride-through”, and protection should be discussed in more detail.

Unofficial Comment Form

Project 2018-04 Modifications to PRC-024-2

Do not use this form for submitting comments. Use the [Standards Balloting and Commenting System \(SBS\)](#) to submit comments on the **Project 2018-04 Modifications to PRC-024-2 Standard Authorization Request**. Comments must be submitted by **8 p.m. Eastern, Friday, January 18, 2019**.

Additional information is available on the [project page](#). If you have questions, contact Standards Developer, [Mat Bunch](#) (via email) or at (404) 446-9785.

Background Information

On November 27, 2018, the NERC Operating Committee (OC) and Planning Committee (PC) submitted a Standard Authorization Request (SAR) prepared by the Inverter-Based Resource Performance Task Force (IRPTF), which reports to the OC and PC.

In 2017, the OC and PC convened the IRPTF shortly after it became clear that inverter-based generation was dropping off-line during normally cleared Bulk Power System (BPS) line faults. The NERC IRPTF supported NERC and WECC staff in the analysis of the [Blue Cut Fire](#) and [Canyon 2 Fire](#) disturbances in southern California. As a stakeholder group of industry experts, the IRPTF developed recommended performance characteristics from inverter-based resources connected to the BPS from the key findings and recommendations in the reports on the analysis.

Based off the disturbance analyses and development of the [PRC-024-2 Gaps Whitepaper](#), the IRPTF identified potential modifications to PRC-024-2 to help ensure that inverter-based generator owners, operators, developers, and equipment manufacturers understand the intent of the standard in order for their plants respond to grid disturbances in a manner that contributes to the reliable operation of the BPS.

This SAR proposes to revise PRC-024-2 to address the issues identified in the standard.

Instructions for Commenting

Please enter comments in simple text format. Bullets, numbers, and some special formatting may not be retained.

Questions

1. Do you agree with the project scope as outlined in the SAR? If you do not agree, or if you agree but have comments or suggestions, provide your recommendation or proposed modification below:

- Yes
 No

Comments:

2. Do you agree with the **Detailed Description** section of the SAR? If you do not agree, or if you agree but have comments or suggestions, provide your recommendation or proposed modification below:

- Yes
 No

Comments:

3. If you have any other comments on this SAR that you haven't already mentioned above, provide them here:

Comments:

Standard Authorization Request (SAR)

Complete and please email this form, with attachment(s) to: sarcomm@nerc.net

The North American Electric Reliability Corporation (NERC) welcomes suggestions to improve the reliability of the bulk power system through improved Reliability Standards.

Requested information

SAR Title:	PRC-024-2 Generator Frequency and Voltage Protective Relay Settings		
Date Submitted:	11/27/2018		
SAR Requester			
Name:	Lloyd Linke (NERC OC Chair) Brian Evans-Mongeon (NERC PC Chair)		
Organization:	Lloyd – Western Area Power Administration (NERC Operating Committee) Brian – Utility Services, Inc. (NERC Planning Committee)		
Telephone:	Lloyd – 605-882-7500 Brian – 802-241-1400	Email:	lloyd@wapa.gov brian.evans-mongeon@utilitysvcs.com
SAR Type (Check as many as apply)			
<input type="checkbox"/> New Standard	<input type="checkbox"/> Imminent Action/ Confidential Issue (SPM Section 10)	<input type="checkbox"/> Variance development or revision	<input type="checkbox"/> Other (Please specify)
<input checked="" type="checkbox"/> Revision to Existing Standard			
<input type="checkbox"/> Add, Modify or Retire a Glossary Term			
<input type="checkbox"/> Withdraw/retire an Existing Standard			
Justification for this proposed standard development project (Check all that apply to help NERC prioritize development)			
<input type="checkbox"/> Regulatory Initiation	<input checked="" type="checkbox"/> NERC Standing Committee Identified	<input type="checkbox"/> Enhanced Periodic Review Initiated	<input checked="" type="checkbox"/> Industry Stakeholder Identified
<input checked="" type="checkbox"/> Emerging Risk (Reliability Issues Steering Committee) Identified			
<input type="checkbox"/> Reliability Standard Development Plan			
Industry Need (What Bulk Electric System (BES) reliability benefit does the proposed project provide?):			
<p>The NERC Integration of Variable Generation Task Force (IVGTF) was convened many years ago and developed a technical report that highlighted a number of topics and issues related to variable generation that would need to be addressed. The NERC IVGTF specifically highlighted that potential changes would need to be made to NERC Standards, including PRC-024-2, to ensure consistency and clarity for inverter-based resources.</p> <p>In 2017, NERC convened the Inverter-Based Resource Performance Task Force (IRPTF) shortly after it became clear that inverter-based generation was dropping off-line during normally cleared BPS line faults. The NERC IRPTF supported NERC and WECC Staff in the analysis of the Blue Cut Fire and Canyon 2 Fire disturbances in southern California.¹ From the key findings and recommendations of those reports,</p>			

¹ An ad-hoc task force supported the development of the Blue Cut Fire disturbance report, which subsequently developed into the NERC IRPTF.

Requested information

the NERC IRPTF as a stakeholder group of industry experts developed recommended performance characteristics from inverter-based resources connected to the BPS. The recommended performance is documented in the NERC Reliability Guideline: BPS-Connected Inverter-Based Resource Performance, published September 2018. During the disturbance analyses and development of the Reliability Guideline, the NERC IRPTF identified a number of technical issues with PRC-024-2 that require clarification and correction to ensure inverter-based generator owners, operators, developers, and equipment manufacturers clearly understand the intent of the standard so their plants respond to grid disturbances in a manner that contributes to the reliable operation of the bulk power system.

These issues include:

- a. Modifying the region outside the “No Trip” zone of the ride through curves so that registered entities do not interpret this area as a must trip zone.
- b. Clarifying the “Off Nominal Frequency Capability Curve” and the “Curve Data Point” tables on pages 8 and 9 of PRC-024-2 to reconcile the apparent 0.1 sec time delay in the frequency capability curve with the curve data point table that allows instantaneous (i.e., no deliberate time delay) operation. Calculation of frequency over a window or time period should also be clarified.
- c. Clarifying the language in point #5 of the Curve Details found in the Voltage Ride-Through Curve Clarifications (page 11 of PRC-024-2) to eliminate confusion as to whether the curves pertain to RMS (Root Mean Square) or crest values. If RMS, clarify that the RMS signal pertains to the fundamental frequency RMS signal rather than the true RMS signal.
- d. Removing inconsistency regarding per unit voltage and nominal operating voltage by correcting point #1 of the Curve Details found in the Voltage Ride-Through Curve Clarifications (page 11 of PRC-024-2).
- e. Clarifying the implied functionality of cumulative time (point #3 of the Curve Details in the Voltage Ride-Through Curve Clarifications – Page 11 of PRC-024-2) by explicitly specifying the conditions for when cumulative values for low and high voltage curves start, stop, and reset.
- f. Clarifying whether the voltage and frequency protection functions within the inverter that can trip the inverter are subject to the standard requirements, and clarify any confusion related to footnote 1.
- g. Clarifying the definition and whether the use of momentary cessation for inverter-based resources within the “No Trip” zone of PRC-024-2 is acceptable. If the use of momentary cessation within the “No Trip” zone of PRC-024-2 should be disallowed, then its use should be reported as an equipment limitation per Requirement R3 if used. The Standard Drafting Team (SDT) should further consider the acceptability of using of momentary cessation for very low voltages within the “No Trip” zone of PRC-024-2.

Requested information

- h. Clarifying how situations of partial tripping (i.e., tripping of some but not all inverters in a dispersed power producing resource) or partial momentary cessation would be treated with respect to PRC-024-2 compliance.

This SAR proposes to address these technical issues.

Purpose or Goal (How does this proposed project provide the reliability-related benefit described above?):

This SAR proposes to revise PRC-024-2 to address ambiguities, inconsistencies, and technical errors within the existing standard. The goal is to add clarity, eliminate inconsistency and address ambiguity in the existing requirements.

Project Scope (Define the parameters of the proposed project):

The proposed scope of this project is as follows:

- a. Update the PRC-024-2 ride-through curves to specify that the area outside the “No Trip” zone is a “May Trip” zone,² so that it is not erroneously interpreted as a “Must Trip” zone
- b. Clarify inconsistencies between the Curve Data Point tables and the Off Nominal Frequency Capability Curves (pages 8 & 9), and ensure that instantaneously calculated frequency is not permissible.
- c. Clarify the language in points #1, #3, and #5 of the Curve Details section of the “Voltage Ride-Through Curve Clarifications” on page 11.
- d. Reinforce that the requirements pertain to the Point of Interconnection, and clarify further that the Generator Owner needs to consider this when developing the voltage settings for individual generating units (this pertains to both synchronous and inverter-based resources). If possible, provide either Implementation Guidance or example calculations within the standard for dispersed power producing (inverter-based) resources.
- e. Clarify if the voltage and frequency protective functions within an inverter control system that trip the inverter are subject to the requirements of PRC-024-2.³
- f. Specify that the use of momentary cessation (a control function) within the “No Trip” zone of PRC-024-2 does not comply with the standard. The SDT should consider the use of momentary cessation for very low voltages within the “No Trip” zone of PRC-024-2. The SDT may need to define momentary cessation, and provide guidance on the performance of inverter control systems during a voltage disturbance within the “No Trip” zone of PRC-024-2.
- g. Clarify how situations of partial tripping or partial momentary cessation would be treated with respect to PRC-024-2 compliance.

² Another option is to refer to this as “Prefer No Trip”. The SDT can determine the best language; however, it should be clear that resources do not necessarily have to trip outside the curve yet are permitted to in order to protect facilities and personnel.

³ This clarification could also further strengthen that station service voltage settings or tripping are not considered in scope of the standard. The standard pertains to the voltage and frequency related tripping directly applied to the individual generating unit(s).

Requested information

Other topics not addressed here will be considered in future activities of the NERC IRPTF as well as the IEEE p2800 project.

Detailed Description (Describe the proposed deliverable(s) with sufficient detail for a drafting team to execute the project. If you propose a new or substantially revised Reliability Standard or definition, provide: (1) a technical justification⁴ which includes a discussion of the reliability-related benefits of developing a new or revised Reliability Standard or definition, and (2) a technical foundation document (e.g., research paper) to guide development of the Standard or definition):

The Standards Drafting Team should address the following technical issues within PRC-024-2:

1. The region outside the “No Trip” zone of the PRC-024-2 ride-through curves should be clearly marked as a “May Trip” zone so this region is not incorrectly interpreted as a “Must Trip” zone. Many newly interconnecting resources (including inverter-based resources) on the BPS are setting voltage and protective functions based solely on these curves, since the area outside the no trip region is incorrectly interpreted as a must trip zone. This practice does not consider the actual capability of the resource to ride through transmission line faults that create conditions outside of the “No Trip” zone. Clarification will help to ensure correct interpretation industry-wide. This will enhance reliability since the generator owner, operator, developer, and equipment manufacturer will understand that the inverter protective trip settings should be based on equipment capability if it exceeds the curves in the standard, minimizing undesired tripping of inverter-based generation that may not be necessary.
2. The “Off Nominal Frequency Capability Curve” (page 8 of PRC-024-2) is a logarithmic graph that starts at time $t=0.1$ seconds. However, the tables in the “Curve Data Point” section (pages 8 and 9 of PRC-024-2) allow for “instantaneous trip”. Frequency cannot and should not be measured or calculated using an instantaneously sampled value. Frequency calculation methods use various types of time windows and filtering methods in order to accurately calculate grid frequency. Typically, these methods use a window on the order of 100 milliseconds (6 cycles). Thus, a delay of 100 milliseconds would occur even if the protective relay algorithm has no intentional time delay. This delay should be reflected in the standard. Also, the IRPTF identified that erroneous tripping due to frequency calculation errors was a significant factor in the Blue Cut Fire disturbance. Eliminating instantaneous tripping for frequency disturbances reduces the probability of incorrect tripping due to spurious noise in the measure voltage, for example during the period of fault clearing.
3. Point #5 in the Curve Details section of the “Voltage Ride-Through Curve Clarifications” (page 11 of PRC-024-2) states, “voltages in the curve assume minimum fundamental frequency phase to ground or phase to phase voltage for the low duration curve and the greater of maximum RMS (Root Mean Square) or crest phase to phase voltage for the high voltage duration curve.” There are a number of ways this can be interpreted, and issues that need to be addressed.

⁴ The NERC Rules of Procedure require a technical justification for new or substantially revised Reliability Standards. Please attach pertinent information to this form before submittal to NERC.

Requested information

- To minimize the probability of incorrect tripping (as noted in point 2 above), any voltage compared with the PRC-024-2 voltage ride through curves should be a well-filtered, fundamental frequency component of the voltage waveform. This will filter out spurious voltage spikes caused by switching action on the BPS. Voltage protective relays should not operate at the voltage levels specified in the voltage ride-through curve using instantaneously sampled values. The clarification should focus on using the RMS value of the voltage, and that the voltage signal should be adequately filtered to obtain this fundamental component.
 - The overvoltage component of the clarification states, “the greater of maximum RMS or crest phase to phase voltage”. The crest value is greater than the RMS value of a periodic waveform, so there is ambiguity regarding which value to apply. Without clarification, inverter based resources may trip based on different criteria. Failure to address this may lead to reliability issues, as identified in the Canyon 2 Fire disturbance analysis report.
 - Only phase to phase voltage is used for the high voltage component of the PRC-024-2 curve. However, inverter-based resource transient overvoltage protection may be based on phase to ground voltage as well. Use of phase to ground voltage for overvoltage protection needs to be considered.
4. Point #1 of the Curve Details section of the “Voltage Ride-Through Curve Clarifications” on page 11 of PRC-024-2 states, “the per unit voltage base for these curves is the nominal operating voltage specified by the Transmission Planner in the analysis of the reliability of the Interconnected Transmission Systems at the point of interconnection to the Bulk Electric System (BES).” Firstly, the Transmission Planner does not specify nominal operating voltage. Regardless, the per unit base for the curves should be based on the nominal voltage level that the generator is connected to at its Point of Interconnection. This is a static value and can be provided by the Transmission Planner.
 5. Point #3 of the Curve Details section of the “Voltage Ride-Through Curve Clarifications” on page 11 of PRC-024-2 states, “The envelope within the curves represents the cumulative voltage duration at the point of interconnection with the BES.” The ride-through curves end at four seconds, and the curves imply a requirement for cumulative time duration for the “No Trip” zone. Protective relays and inverter protective functions within their control systems must be set to accommodate the cumulative nature of ride through curves. Under the current version of PRC-024-2, it is not explicitly clear at what point the cumulative values for the low and high voltage curves start, stop, and reset. There are multiple ways to implement this cumulative effect, which result in different performance. The correct methods for implementing the cumulative time duration should be clarified in PRC-024-2.⁵

⁵ Example: One implementation considers one cumulative window timer for both low voltage and high voltage curves, and it starts when the voltage goes outside the continuous operating bounds. Another implementation considers separate cumulative timers and the HV timer starts when the voltage is greater than this curve and the LV timer starts when the voltage is less than that curve.

Requested information

6. The IRPTF identified that it is ambiguous and unclear as to whether the requirements of PRC-024-2 apply to the individual inverters. Footnote 1 does state that “protective functions within control systems that directly trip or provide tripping signals to the generator based on frequency or voltage inputs” are considered as part of the standard. Yet, the group acknowledged that the vagueness of the footnote as well as the synchronous generator-centric language in the requirements makes this confusing. There may exist multiple types of voltage and frequency protection, including relaying or individual inverter protective functions within their control systems that need to be considered in PRC-024-2. This should be clarified and strengthened throughout the standard.
7. Momentary cessation is a form of operation that some inverters have historically used during “ride-through” operation where voltage is outside the continuous operating range of the inverter. Momentary cessation is when zero current is injected into the grid by the inverter. This occurs because the power electronic firing commands are blocked so that the inverter does not produce current. Thus active and reactive current (and subsequently power) go to zero at the inverter terminals. The NERC IRPTF performed stability studies, particularly in the Western Interconnection, and demonstrated that the propagation and widespread use of momentary cessation, particularly at voltages within the PRC-024-2 voltage ride-through curve, could cause potential situations of instability. Both NERC Alerts following the Blue Cut Fire and Canyon 2 Fire gathered data related to the use of momentary cessation, and the latter NERC Alert explicitly recommended mitigating the use of momentary cessation to the best extent possible for existing and future resources. Clarifying PRC-024-2 relative to the use of momentary cessation within the “No Trip” zone of PRC-024-2 aligns with all these efforts. Momentary cessation within the “No Trip” zone of PRC-024-2 could be reported as an equipment limitation per Requirement R3.

Cost Impact Assessment, if known (Provide a paragraph describing the potential cost impacts associated with the proposed project):

This SAR proposes to clarify some issues and correct others. The cost impact is unknown, but in many cases is expected to be minimal (i.e., will only require changes to existing inverter control software and setting).

Please describe any unique characteristics of the BES facilities that may be impacted by this proposed standard development project (e.g. Dispersed Generation Resources):

Inverter-based resources including asynchronous ties may be impacted by this proposed standard development as Generator Owners, Transmission Owners and Original Equipment Manufacturers may need to change the control programming to enhance capabilities. Other generation resources may be impacted if the clarifications cause them to correct relay settings.

To assist the NERC Standards Committee in appointing a drafting team with the appropriate members, please indicate to which Functional Entities the proposed standard(s) should apply (e.g. Transmission Operator, Reliability Coordinator, etc. See the most recent version of the NERC Functional Model for definitions):

Generator Owners

Requested information	
Do you know of any consensus building activities ⁶ in connection with this SAR? If so, please provide any recommendations or findings resulting from the consensus building activity.	
Many of these proposals were developed by the NERC IRPTF, are outlined in the NERC Reliability Guideline: BPS-Connected Inverter-Based Resource Performance, and also captured in a white paper on potential standards gaps related to PRC-024-2. There were also similar proposals developed by the NERC IVGTF in 2015.	
Are there any related standards or SARs that should be assessed for impact as a result of this proposed project? If so which standard(s) or project number(s)?	
Are there alternatives (e.g. guidelines, white paper, alerts, etc.) that have been considered or could meet the objectives? If so, please list the alternatives.	
<p>The following materials have been developed by the NERC IRPTF, NERC Staff, and WECC Staff as part of the event analyses of inverter-based resources during BPS disturbances. However, these activities do not address the inconsistencies and technical issues of PRC-024-2 that have been highlighted in all these activities.</p> <ul style="list-style-type: none"> • Reliability Guideline: BPS-Connected Inverter-Based Resource Performance: https://www.nerc.com/comm/OC_Reliability_Guidelines_DL/Inverter-Based_Resource_Performance_Guideline.pdf. • Blue Cut Fire Disturbance Report: http://www.nerc.com/pa/rrm/ea/Pages/1200-MW-Fault-Induced-Solar-Photovoltaic-Resource-Interruption-Disturbance-Report.aspx. • Canyon 2 Fire Disturbance Report: https://www.nerc.com/pa/rrm/ea/October%209%202017%20Canyon%202%20Fire%20Disturbance%20Report/900%20MW%20Solar%20Photovoltaic%20Resource%20Interruption%20Disturbance%20Report.pdf. • NERC Alert I: Loss of Solar Resources during Transmission Disturbances due to Inverter Settings: https://www.nerc.com/pa/rrm/bpsa/Pages/Alerts.aspx. • NERC Alert II: Loss of Solar Resources during Transmission Disturbances due to Inverter Settings: https://www.nerc.com/pa/rrm/bpsa/Pages/Alerts.aspx. • "NERC IVGTF Summary and Recommendation Report", published in June 2015. Relevant to PRC-024-02 are task 1-3 and 1-7: https://www.nerc.com/comm/PC/Integration%20of%20Variable%20Generation%20Task%20Force%201/IVGTF%20Summary%20and%20Recommendation%20Report_Final.pdf. 	

Reliability Principles	
Does this proposed standard development project support at least one of the following Reliability Principles (Reliability Interface Principles)? Please check all those that apply.	
<input checked="" type="checkbox"/>	1. Interconnected bulk power systems shall be planned and operated in a coordinated manner to perform reliably under normal and abnormal conditions as defined in the NERC Standards.

⁶ Consensus building activities are occasionally conducted by NERC and/or project review teams. They typically are conducted to obtain industry inputs prior to proposing any standard development project to revise, or develop a standard or definition.

Reliability Principles	
<input checked="" type="checkbox"/>	2. The frequency and voltage of interconnected bulk power systems shall be controlled within defined limits through the balancing of real and reactive power supply and demand.
<input type="checkbox"/>	3. Information necessary for the planning and operation of interconnected bulk power systems shall be made available to those entities responsible for planning and operating the systems reliably.
<input type="checkbox"/>	4. Plans for emergency operation and system restoration of interconnected bulk power systems shall be developed, coordinated, maintained and implemented.
<input type="checkbox"/>	5. Facilities for communication, monitoring and control shall be provided, used and maintained for the reliability of interconnected bulk power systems.
<input type="checkbox"/>	6. Personnel responsible for planning and operating interconnected bulk power systems shall be trained, qualified, and have the responsibility and authority to implement actions.
<input type="checkbox"/>	7. The security of the interconnected bulk power systems shall be assessed, monitored and maintained on a wide area basis.
<input type="checkbox"/>	8. Bulk power systems shall be protected from malicious physical or cyber attacks.

Market Interface Principles	
Does the proposed standard development project comply with all of the following Market Interface Principles ?	Enter (yes/no)
1. A reliability standard shall not give any market participant an unfair competitive advantage.	Yes
2. A reliability standard shall neither mandate nor prohibit any specific market structure.	Yes
3. A reliability standard shall not preclude market solutions to achieving compliance with that standard.	Yes
4. A reliability standard shall not require the public disclosure of commercially sensitive information. All market participants shall have equal opportunity to access commercially non-sensitive information that is required for compliance with reliability standards.	Yes

Identified Existing or Potential Regional or Interconnection Variances	
Region(s)/ Interconnection	Explanation
None	None

For Use by NERC Only

SAR Status Tracking (Check off as appropriate)	
<input type="checkbox"/> Draft SAR reviewed by NERC Staff	<input type="checkbox"/> Final SAR endorsed by the SC
<input type="checkbox"/> Draft SAR presented to SC for acceptance	<input type="checkbox"/> SAR assigned a Standards Project by NERC
<input type="checkbox"/> DRAFT SAR approved for posting by the SC	

	<input type="checkbox"/> SAR denied or proposed as Guidance document
--	--

Version History

Version	Date	Owner	Change Tracking
1	June 3, 2013		Revised
1	August 29, 2014	Standards Information Staff	Updated template
2	January 18, 2017	Standards Information Staff	Revised
2	June 28, 2017	Standards Information Staff	Updated template

Standards Announcement

Project 2018-04 Modifications to PRC-024-2

Formal Comment Period Open through January 18, 2019

[Now Available](#)

A formal comment period for the **Project 2018-04 Modifications to PRC-024-2 Standard Authorization Request (SAR)** is open through **8 p.m. Eastern, Friday, January 18, 2019**.

Commenting

Use the [Standards Balloting and Commenting System \(SBS\)](#) to submit comments. If you experience issues using the SBS, contact [Wendy Muller](#). An unofficial Word version of the comment form is posted on the [project page](#).

- *If you are having difficulty accessing the SBS due to a forgotten password, incorrect credential error messages, or system lock-out, contact NERC IT support directly at <https://support.nerc.net/> (Monday – Friday, 8 a.m. - 5 p.m. Eastern).*
- *Passwords expire every **6 months** and must be reset.*
- *The SBS **is not** supported for use on mobile devices.*
- *Please be mindful of ballot and comment period closing dates. We ask to **allow at least 48 hours** for NERC support staff to assist with inquiries. Therefore, it is recommended that users try logging into their SBS accounts **prior to the last day**.*

Next Steps

The SAR drafting team will review all responses received during the comment period and determine the next steps of the project.

For information on the Standards Development Process, refer to the [Standard Processes Manual](#).

For more information or assistance, contact Standards Developer, [Mat Bunch](#) (via email) or at (404) 446-9785.

North American Electric Reliability Corporation
3353 Peachtree Rd, NE
Suite 600, North Tower
Atlanta, GA 30326
404-446-2560 | www.nerc.com

Comment Report

Project Name: 2018-04 Modifications to PRC-024-2 | Standard Authorization Request
Comment Period Start Date: 12/19/2018
Comment Period End Date: 1/18/2019
Associated Ballots:

There were 35 sets of responses, including comments from approximately 118 different people from approximately 94 companies representing 10 of the Industry Segments as shown in the table on the following pages.

Questions

1. Do you agree with the project scope as outlined in the SAR? If you do not agree, or if you agree but have comments or suggestions, provide your recommendation or proposed modification below:

2. Do you agree with the Detailed Description section of the SAR? If you do not agree, or if you agree but have comments or suggestions, provide your recommendation or proposed modification below:

3. If you have any other comments on this SAR that you haven't already mentioned above, provide them here:

Organization Name	Name	Segment(s)	Region	Group Name	Group Member Name	Group Member Organization	Group Member Segment(s)	Group Member Region
Florida Municipal Power Agency	Brandon McCormick	3,4,5,6	FRCC	FMPA	Tim Beyrle	City of New Smyrna Beach Utilities Commission	4	FRCC
					Jim Howard	Lakeland Electric	5	FRCC
					Javier Cisneros	Fort Pierce Utilities Authority	3	FRCC
					Randy Hahn	Ocala Utility Services	3	FRCC
					Don Cuevas	Beaches Energy Services	1	FRCC
					Jeffrey Partington	Keys Energy Services	4	FRCC
					Tom Reedy	Florida Municipal Power Pool	6	FRCC
					Steven Lancaster	Beaches Energy Services	3	FRCC
					Chris Adkins	City of Leesburg	3	FRCC
					Ginny Beigel	City of Vero Beach	3	FRCC
Duke Energy	Colby Bellville	1,3,5,6	FRCC,RF,SERC	Duke Energy	Doug Hils	Duke Energy	1	RF
					Lee Schuster	Duke Energy	3	FRCC
					Dale Goodwine	Duke Energy	5	SERC
					Greg Cecil	Duke Energy	6	RF
MRO	Dana Klem	1,2,3,4,5,6	MRO	MRO NSRF	Joseph DePoorter	Madison Gas & Electric	3,4,5,6	MRO
					Larry Heckert	Alliant Energy	4	MRO
					Amy Casucelli	Xcel Energy	1,3,5,6	MRO
					Michael Brytowski	Great River Energy	1,3,5,6	MRO

					Jodi Jensen	Western Area Power Administration	1,6	MRO
					Kayleigh Wilkerson	Lincoln Electric System	1,3,5,6	MRO
					Mahmood Safi	Omaha Public Power District	1,3,5,6	MRO
					Brad Parret	Minnesota Power	1,5	MRO
					Terry Harbour	MidAmerican Energy Company	1,3	MRO
					Tom Breene	Wisconsin Public Service Corporation	3,5,6	MRO
					Jeremy Voll	Basin Electric Power Cooperative	1	MRO
					Kevin Lyons	Central Iowa Power Cooperative	1	MRO
					Mike Morrow	Midcontinent ISO	2	MRO
PPL - Louisville Gas and Electric Co.	Devin Shines	3,5,6	RF,SERC	Louisville Gas and Electric Company and Kentucky Utilities Company	Charles Freibert	PPL - Louisville Gas and Electric Co.	3	SERC
					JULIE HOSTRANDER	PPL - Louisville Gas and Electric Co.	5	SERC
					Linn Oelker	PPL - Louisville Gas and Electric Co.	6	SERC
Great Plains Energy - Kansas City Power and Light Co.	Douglas Webb	1,3,5,6	MRO,SPP RE	Westar-KCPL	Doug Webb	Westar	1,3,5,6	MRO
					Doug Webb	KCP&L	1,3,5,6	MRO
ACES Power Marketing	Jodirah Green	6	NA - Not Applicable	ACES Standard Collaborations	John Shaver	Arizona Electric Power Cooperative, Inc.	1	WECC

					Bob Solomon	Hoosier Energy Rural Electric Cooperative, Inc.	1	SERC
					Greg Froehling	Rayburn Country Electric Cooperative, Inc.	3,6	Texas RE
					Kevin Lyons	Central Iowa Power Cooperative	1	MRO
					Jenny Knernschild	Old Dominion Electric Cooperative	3,4	SERC
					Susan Sosbe	Wabash Valley Power Association	3	RF
					Ginger Mercier	Prairie Power, Inc.	1,3	SERC
					Kagen DelRio	North Carolina Electric Membership Cooperative	3,4,5	SERC
DTE Energy - Detroit Edison Company	Karie Barczak	3,4,5		DTE Energy - DTE Electric	Jeffrey Depriest	DTE Energy - DTE Electric	5	RF
					Daniel Herring	DTE Energy - DTE Electric	4	RF
					Karie Barczak	DTE Energy - DTE Electric	3	RF
Manitoba Hydro	Mike Smith	1,3,5,6		Manitoba Hydro	Yuguang Xiao	Manitoba Hydro	5	MRO
					Karim Abdel-Hadi	Manitoba Hydro	3	MRO
					Blair Mukanik	Manitoba Hydro	6	MRO
					Mike Smith	Manitoba Hydro	1	MRO
Southern Company - Southern Company Services, Inc.	Pamela Hunter	1,3,5,6	SERC	Southern Company	Katherine Prewitt	Southern Company Services, Inc.	1	SERC
					Joel Dembowski	Southern Company - Alabama	3	SERC

						Power Company		
					William D. Shultz	Southern Company Generation	5	SERC
					Jennifer G. Sykes	Southern Company Generation and Energy Marketing	6	SERC
Northeast Power Coordinating Council	Ruida Shu	1,2,3,4,5,6,7,8,9,10	NPCC	RSC no Dominion	Guy V. Zito	Northeast Power Coordinating Council	10	NPCC
					Randy MacDonald	New Brunswick Power	2	NPCC
					Glen Smith	Entergy Services	4	NPCC
					Brian Robinson	Utility Services	5	NPCC
					Alan Adamson	New York State Reliability Council	7	NPCC
					David Burke	Orange & Rockland Utilities	3	NPCC
					Michele Tondalo	UI	1	NPCC
					Helen Lainis	IESO	2	NPCC
					Michael Jones	National Grid	3	NPCC
					Sean Cavote	PSEG	4	NPCC
					Kathleen Goodman	ISO-NE	2	NPCC
					David Kiguel	Independent	NA - Not Applicable	NPCC
					Silvia Mitchell	NextEra Energy - Florida Power and Light Co.	6	NPCC
					Paul Malozewski	Hydro One Networks, Inc.	3	NPCC
					Gregory Campoli	New York Independent	2	NPCC

					System Operator			
					Caroline Dupuis	Hydro Quebec	1	NPCC
					Chantal Mazza	Hydro Quebec	2	NPCC
					Michael Forte	Con Edison	1	NPCC
					Laura McLeod	NB Power Corporation	5	NPCC
					Nick	Kowalczyk	1	NPCC
					Dermot Smyth	Con Ed - Consolidated Edison Co. of New York	1	NPCC
					John Hastings	National Grid	1	NPCC
					Peter Yost	Con Ed - Consolidated Edison Co. of New York	3	NPCC
					Sofia Gadea-Omelchenko	Con Edison	5	NPCC
					Joel Charlebois	AESI - Acumen Engineered Solutions International Inc.	5	NPCC
					Quintin Lee	Eversource Energy	1	NPCC
					Mike Cooke	Ontario Power Generation, Inc.	4	NPCC
					Salvatore Spagnolo	New York Power Authority	1	NPCC
					Shivaz Chopra	New York Power Authority	5	NPCC
Dominion - Dominion Resources, Inc.	Sean Bodkin	3,5,6		Dominion	Connie Lowe	Dominion - Dominion Resources, Inc.	3	NA - Not Applicable
					Lou Oberski	Dominion - Dominion Resources, Inc.	5	NA - Not Applicable

					Larry Nash	Dominion - Dominion Virginia Power	1	NA - Not Applicable
--	--	--	--	--	------------	--	---	------------------------

1. Do you agree with the project scope as outlined in the SAR? If you do not agree, or if you agree but have comments or suggestions, provide your recommendation or proposed modification below:

Dana Klem - MRO - 1,2,3,4,5,6 - MRO, Group Name MRO NSRF

Answer No

Document Name

Comment

The SDT should clearly state the scope of protective devices or relays. Is the scope protective relays only or is it protective devices in addition to relays?

The MRO NSRF recommends that SDT clarify item e in the SAR to align with the PRC-024 reliability objective and the current NERC Protection System definition. Item e from:

Clarify if the voltage and frequency protective functions within an inverter control system that trip the inverter are subject to the requirements of PRC-024-2.3

to:

Clarify the PRC-024 scope is to identify and set frequency and voltage protective relays or protective devices that respond to electrical quantities and directly trip the generator

This attempts to remain technology neutral, is consistent with the NERC Protection System definition, and specifically targets protective functions that directly trip the generator, and avoids other unintended consequences.

Regarding Item d and the reference to "individual" generating units, the objective is to cover or "consider" the largest and smallest impedances in the voltage drop calculations. We recommend striking the "individual" generating unit reference and state, "...the Generator Owner needs to consider the largest and smallest impedances in its voltage drop calculations". This should meet the reliability object without forcing entities to show voltage drop calculations for each wind turbine or solar inverter for zero defect compliance audits.

Likes 0

Dislikes 0

Response

Sean Bodkin - Dominion - Dominion Resources, Inc. - 3,5,6, Group Name Dominion

Answer No

Document Name

Comment

Dominion Energy supports the comments submitted by EEI regarding items included in the current SAR that should not be included in the scope of this proposed project.

Likes 0

Dislikes 0

Response

Richard Vine - California ISO - 2

Answer

No

Document Name

Comment

The California ISO supports the comments of the ISO/RTO Council Standards Review Committee (SRC)

Likes 0

Dislikes 0

Response

Colby Bellville - Duke Energy - 1,3,5,6 - FRCC,SERC,RF, Group Name Duke Energy

Answer

No

Document Name

Comment

Issue B: The SDT should also consider making this minimum time delay greater than 0.1 sec. A suggested minimum time delay around 0.5 to 1.0 seconds would be more appropriate. This will allow for better ride-through of somewhat prolonged, slower swings. It will also better coordinate with the minimum time delay for UFLS actuation. (At least in SERC, a minimum time delay of 6 cycles [0.1 sec] is required per UFLS standard PRC-006-SERC-02.) A longer time delay in the suggested range will have no adverse impact on system operation or equipment damage.

Issue C: RMS should be used as a practical matter in terms of the typical instrumentation available for calibration of the equipment involved. We would also suggest that distinguishing between “fundamental frequency RMS” and “True RMS” (i.e. all frequency components) is unnecessary from a practical perspective. In the vast majority of cases, fundamental frequency is the very dominant component. Recognizing that inverters themselves can create a significant level of harmonics, if this is considered by the SDT as important, the ride-through value(s) selected for the curves/equations should be modified to accommodate either without the need to make special instrument accommodations to determine one or the other.

Issue G: The use of momentary cessation within the “No Trip” zone of PRC-024-2 should be disallowed. If it happens, it should be reported as an equipment limitation per Requirement R3. Since the momentary cessation is an integral part of the basic inverter design, the SDT should consider working with the NERC Inverter-Based Resource Performance Task Force (IRPTF) to incorporate some explanation in PRC-024 regarding the different considerations for inverter-based generation resources as compared to synchronous generation resources. The Rationale section of PRC-024 might be a good place for such explanation.

Likes 0

Dislikes 0

Response

Tamara Evey - Ameren - Ameren Services - 1,3,5,7 - SERC

Answer No

Document Name

Comment

Ameren agrees with and supports EEI comments for question #1.

Likes 0

Dislikes 0

Response

Douglas Johnson - American Transmission Company, LLC - 1

Answer No

Document Name

Comment

American Transmission Company LLC (ATC) supports and endorses the comments submitted by the Edison Electric Institute (EEI) on behalf of the EEI member companies.

Likes 0

Dislikes 0

Response

Ruida Shu - Northeast Power Coordinating Council - 1,2,3,4,5,6,7,8,9,10 - NPCC, Group Name RSC no Dominion

Answer No

Document Name

Comment

Reliability standards should be technology neutral. The project scope should be limited to removing ambiguity from the standard. Technical Rationale documents and/or Compliance Implementation Guidance documents could be written if the drafting team determines that further explanation is needed for inverter-based generation.

Likes 0

Dislikes 0

Response

Answer No

Document Name

Comment

Kansas City Power & Light and Westar Energy (“the Company”) supports the Edison Electric Institute’s (EEI) submitted responses.

Also, the Company offers that, broadly, for the Company’s full response, it supports NERC’s efforts to revise PRC-024. It believes the project will contribute to improving reliability and resilience with the result of strengthening performance of the grid operations. Clarity, consistency and communications for all stakeholders is a strong step forward in grid reliability.

Additionally, revisions to PRC-024 should accommodate a wide view when considering Inverter Based Resources (IBR), and take care not to consider IBRs singularly within a narrow focus, which may inadvertently omit something with an equally large system impact.

It is within the framework of the above statements we offer the following comments on the proposed SAR project scope:

Item a: The Company endorses EEI’s comments.

Item b: The Company endorses EEI’s comments.

Item c: The Company endorses EEI’s comments.

Item d: The Company endorses EEI’s comments.

Additionally, the Company would highlight it does not have a predetermined point of view regarding the need for additional Implementation Guidance. On the other hand, it may very well be necessary. Development of Implementation Guidance is an option of every Standards Drafting project and / or team, the Company believes the reference in the SAR is unnecessary and be removed.

Item e: The Company endorses EEI’s comments.

Item f: The Company endorses EEI’s comments; however, takes exception on one point.

The Company supports the SAR in adding a definition of momentary cessation to mitigate confusion within the compliance arena, the Company believes this to be necessary.

Item g:

The Company endorses EEI’s comments and supplements its response with the following:

The Company does not have a predetermined point of view regarding the need for additional Implementation Guidance. On the other hand, it may very well be necessary. Development of Implementation Guidance is an option of every Standards Drafting project and / or team, the Company believes the reference in the SAR is unnecessary and be removed.

Likes 0

Dislikes 0

Response

Mark Gray - Edison Electric Institute - NA - Not Applicable - NA - Not Applicable

Answer	No
Document Name	
Comment	
<p>EEI supports revisions to PRC-024-2 that seek to address ambiguities and inconsistencies related to inverter-based resources; however, the SAR project scope does not appear to be technology-neutral. EEI agrees with FERC and NERC that the Reliability Standards should be technology-neutral (FERC Order 779, P81). The project scope should focus on removing ambiguity and enhancing Generator Owner understanding of how resources, regardless of type, are to be configured to ensure generator protection, regardless of where it resides, is properly set to ensure correct operation during defined frequency and voltage excursions.</p> <p>It is within the context of above stated concerns that we offer the following comments on the current SAR project scope:</p> <p>Item a: Overall, we support this scope item because we agree that operation outside of the “No Trip” zone should not be interpreted as a must trip zone. However, we do not agree with footnote 2 because it adds confusion to the scope and recommend that it be struck from the SAR. Additionally, we suggest consideration be given to removing the use of quotes and capitalization with regards to the term “May Trip,” in order to provide the SDT with the necessary latitude to select the best language to define this region.</p> <p>Item b: Instantaneous sampling of frequency by IBRs was a contributing factor in the Blue Cut Fire and we understand that manufacturers of IBRs have already addressed this issue. (See 900 MW Fault Induced Solar Photovoltaic Resource Interruption Disturbance Report (i.e., Canyon 2 Report), Key Findings 1 on page iv). The SDT should limit their work on this item to clarifying that frequency should not be calculated instantaneously to define trip parameters. We recommend changing “and ensure” to “to ensure” and adding “to define the trip parameters” to the end of item b. We believe that the scope of this SAR should steer clear of defining technology specifications. Organizations such as the IEEE are more effective and efficient venues for developing such specifications for how frequency is to be measured because their process would allow the manufacturers and the industry to work through these issues. This is similar to when relay manufacturers began developing microprocessor relays for the Industry. Relay manufacturers worked with appropriate standards making organizations such as the IEEE, which worked with industry and manufacturers to develop products that met the needs of the industry.</p> <p>Item c: EEI supports clarifications to the Voltage Ride-Through Curve Clarifications for Curve Details 1, 3 and 5; however, encourages NERC to do this in a technology-neutral manner rather than providing IBR specifications.</p> <p>Item d: EEI recommends that item “d” be removed from the SAR scope. It is unclear why the requirements would need to be reinforced or clarified further since the language contained in Requirement R2 is clear that generator voltage protective relay settings are to be set so that generator voltage relays do not trip as a result of defined voltage excursions at the Point of Interconnection. We are unaware of any on-going compliance concerns or confusion on this point and are concerned that this scope item may lead to prescriptive language in an attempt to address specific resource types or site configurations, which will move the standard away from a results-based standard. If during the development process for this standard the SDT determines that new Implementation Guidance is needed, based on their modifications to PRC-024-2; we would support such actions but do not believe this needs to be in the SAR language.</p> <p>Item e: EEI supports the concept that generator voltage and frequency protection within an inverter control system, regardless of where it resides, should do so in conformance with PRC-024. We support the SAR’s position that there is a lack of clarity in the language of the currently enforceable version of PRC-024, noting that the intent is to limit this Reliability Standard to generator frequency and generator voltage protective relays but there is no clear acknowledgement or guidance related to generator trips that could result from a generating plant’s auxiliary equipment protection systems (either directly or via tripping signals). We suggest modifying this SAR scope item to: “Clarify that the PRC-024 reliability objective is to identify and set generator frequency and generator voltage protective relays or other protective devices that respond to electrical quantities and directly trip the generator.”</p> <p>Item f: While EEI member companies have varied views on this issue, we agree that there are reliability benefits to providing language in PRC-024 that state that momentary cessation (a control function) is an unacceptable response during system disturbances within the “No Trip” zone as defined within PRC-024. While we recognize that this mode of operation can be a useful response for resources connected at a distribution level, those resources are generally excluded from consideration due to the BES definition exclusion rules. We also recommend that the second sentence under this scope item be struck from the SAR since all BES resources should be held to the same standard in a technology neutral manner. EEI sees benefit in defining</p>	

momentary cessation, within the Glossary of Terms, if the SDT decides to utilize this term within revisions to PRC-024. However, we do not believe that the last sentence in this scope item is necessary for the SAR Scope. Although the sentence includes “may need,” it is understood that the SDT has flexibility to determine whether momentary cessation should be defined and whether guidance should be provided.

Item g: EEI recommends that this scope item be removed from the SAR Scope because we do not believe that compliance treatment for specific non-compliance violations is an appropriate element of a NERC Reliability Standard. We also believe that it is clear that all BES resources, regardless of type or technology, at a plant site should operate in line with the frequency and voltage requirements as set forth in this Reliability Standard (i.e., do not trip within the “No Trip” zone), unless there are known regulatory or equipment limitations. In those cases, the equipment limitations are to be reported to the Planning Coordinator and Transmission Coordinator per Requirement R3. For this reason, we do not believe that this scope item is needed. The SDT may decide that implementation guidance may be appropriate to help address compliance questions; however, we do not believe that Implementation Guidance should be a SAR Scope item because it is understood that this is an option for all SDTs.

Likes 0

Dislikes 0

Response

Devin Shines - PPL - Louisville Gas and Electric Co. - 3,5,6 - SERC, Group Name Louisville Gas and Electric Company and Kentucky Utilities Company

Answer No

Document Name

Comment

Louisville Gas and Electric Company and Kentucky Utilities Company (LG&E/KU) supports the comments submitted by the Edison Electric Institute (EEI).

Likes 0

Dislikes 0

Response

Charles Yeung - Southwest Power Pool, Inc. (RTO) - 2

Answer No

Document Name [Unofficial_Comment_Form_20180718_Jan18.docx](#)

Comment

There is a concern that in the pursuit of clarification through explanatory text, the standards drafting team might include non-essential verbiage which could be subject to compliance and audit when that is not the intent.

While we generally agree with the scope, the bullet “a” for the project scope should be modified to reflect that the region outside the trip curve should reflect equipment limitations and not simply be a “May Trip” zone. Generators should provide grid support during disturbances until equipment limitations are reached. Bullet “a” should be modified as reflected below.

The proposed scope of this project is as follows:

Update the PRC-024-2 ride-through curves to specify that the area outside the “No Trip” zone is an “Equipment Limitation” “May Trip” zone, so that it is not erroneously interpreted as a “Must Trip” zone and define that region to have generators set to allow ride-through until an equipment limitation is reached (Redlines and strikethoughs cannot be shown in this text box - please to the attachment word file for clarity)

With respect to part d of the Project Scope portion of the SAR, the following portion appears to be outside the scope of the existing standard, which is protection, not voltage settings:

“. . . and clarify further that the Generator Owner needs to consider this when developing the voltage settings for individual generating units (this pertains to both synchronous and inverter-based resources). If possible, provide either Implementation Guidance or example calculations within the standard for dispersed power producing (inverter-based) resources.”

Likes 0

Dislikes 0

Response

Pamela Hunter - Southern Company - Southern Company Services, Inc. - 1,3,5,6 - SERC, Group Name Southern Company

Answer

No

Document Name

Comment

We do not completely agree with the project scope. Please find comments, suggestions, and recommendations for certain sections below.

Project Scope Item a: We believe that the wording found footnote 1 is adequate and sufficient to indicate that the voltage and frequency protective equipment application is neither required to be installed or activated due to the requirements of this standard. Note the wording of the footnote reads "Each Generator Owner is not required to have frequency or voltage protective relaying (...) installed or activated on its unit.

Project Scope Item b: The Off Nominal Frequency Capability Curve is drawn on a semi-log graph which makes it impossible to show the zero time stamp. The table of values provides this clarification. We agree that inaccurate frequency measurements should not be used in protection trip equations.

Project Scope Item c: The voltage ride-through time duration curve is plotted in per unit voltage, so the specific voltage chosen to be evaluated may be either RMS or crest values.

Project Scope Items e and f: Since the standard pertains to the voltage and frequency protective functions which directly trip the plant and are applied to the individual generating unit, we agree that voltage and frequency protection functions applied uniformly within each inverter controller, when acting together to emulate a single protection element for the entire plant, should be included in the scope of the existing PRC-024. While the parenthetical elements found in footnote 1 of the existing standard were addressing the multi-function microprocessor based protective relays and the microprocessor-based excitation control systems with protection elements that replicated the digital protective relays, we believe that it applies to inverter-based protection elements set commonly across a plant for tripping. Further, the notion of what is meant by "tripping" needs to be clarified to be the shutdown action performed by the protection system which requires manual intervention for restarting the plant (reset, reclose, re-sync, etc.) The pause and automatic restart control function performed at many inverter-based generating stations is a control feature rather than a protection system feature. Automatic restarts are not advisable for any protection system operation without manual intervention and investigation. Project Scope Item g: Owners of power conversion equipment used for power generation whose control functionality does not have the capability to be set up to eliminate momentary cessation should be provided the documentation option provided in Requirement R3 of PRC-024-2. This could be clarified as permissible through modification of the existing footnote 5 by "not excluding the limitations that are caused by the setting capability of the control system."

Likes 0

Dislikes 0

Response

Kevin Salsbury - Berkshire Hathaway - NV Energy - 5

Answer

No

Document Name

Comment

NV Energy supports revisions to PRC-024-2 that seek to address ambiguities and inconsistencies related to inverter-based resources; however, the SAR project scope does not appear to be technology-neutral. NV Energy agrees with FERC and NERC that the Reliability Standards should be technology-neutral (FERC Order 779, P81). The project scope should focus on removing ambiguity and enhancing Generator Owner understanding of how resources, regardless of type, are to be configured to ensure generator protection, regardless of where it resides, is properly set to ensure correct operation during defined frequency and voltage excursions.

It is within the context of above stated concerns that we offer the following comments on the current SAR project scope:

Item a: Overall, we support this scope item because we agree that operation outside of the "No Trip" zone should not be interpreted as a must trip zone. However, we do not agree with footnote 2 because it adds confusion to the scope and recommend that it be struck from the SAR. Additionally, we suggest consideration be given to removing the use of quotes and capitalization with regards to the term "May Trip," in order to provide the SDT with the necessary latitude to select the best language to define this region.

Item b: Instantaneous sampling of frequency by IBRs was a contributing factor in the Blue Cut Fire and we understand that manufacturers of IBRs have already addressed this issue. (See 900 MW Fault Induced Solar Photovoltaic Resource Interruption Disturbance Report (i.e., Canyon 2 Report), Key Findings 1 on page iv). The SDT should limit their work on this item to clarifying that frequency should not be calculated instantaneously to define trip parameters. We recommend changing “and ensure” to “to ensure” and adding “to define the trip parameters” to the end of item b. We believe that the scope of this SAR should steer clear of defining technology specifications. Organizations such as the IEEE are more effective and efficient venues for developing such specifications for how frequency is to be measured because their process would allow the manufacturers and the industry to work through these issues. This is similar to when relay manufacturers began developing microprocessor relays for the Industry. Relay manufacturers worked with appropriate standards making organizations such as the IEEE, which worked with industry and manufacturers to develop products that met the needs of the industry.

Item c: NV Energy supports clarifications to the Voltage Ride-Through Curve Clarifications for Curve

Details 1, 3 and 5; however, encourages NERC to do this in a technology-neutral manner rather than providing IBR specifications.

Item d: NV Energy recommends that item “d” be removed from the SAR scope. It is unclear why the requirements would need to be reinforced or clarified further since the language contained in

Requirement R2 is clear that generator voltage protective relay settings are to be set so that generator voltage relays do not trip as a result of defined voltage excursions at the Point of Interconnection. We are unaware of any on-going compliance concerns or confusion on this point and are concerned that this scope item may lead to prescriptive language in an attempt to address specific resource types or site configurations, which will move the standard away from a results-based standard. If during the development process for this standard the SDT determines that new Implementation Guidance is needed, based on their modifications to PRC-024-2; we would support such actions but do not believe this needs to be in the SAR language.

Item e: NV Energy supports the concept that generator voltage and frequency protection within an inverter control system, regardless of where it resides, should do so in conformance with PRC-024. We support the SAR’s position that there is a lack of clarity in the language of the currently enforceable version of PRC-024, noting that the intent is to limit this Reliability Standard to generator frequency and generator voltage protective relays but there is no clear acknowledgement or guidance related to generator trips that could result from a generating plant’s auxiliary equipment protection systems (either directly or via tripping signals). We suggest modifying this SAR scope item to: “Clarify that the PRC-024 reliability objective is to identify and set generator frequency and generator voltage protective relays or other protective devices that respond to electrical quantities and directly trip the generator.”

Item f: While NV Energy member companies have varied views on this issue, we agree that there are reliability benefits to providing language in PRC-024 that state that momentary cessation (a control function) is an unacceptable response during system disturbances within the “No Trip” zone as defined within PRC-024. While we recognize that this mode of operation can be a useful response for resources connected at a distribution level, those resources are generally excluded from consideration due to the BES definition exclusion rules. We also recommend that the second sentence under this scope item be struck from the SAR since all BES resources should be held to the same standard in a technology neutral manner. NV Energy sees benefit in defining momentary cessation, within the Glossary of Terms, if the SDT decides to utilize this term within revisions to PRC-024. However, we do not believe that the last sentence in this scope item is necessary for the SAR Scope. Although the sentence includes “may need,” it is understood that the SDT has flexibility to determine whether momentary cessation should be defined and whether guidance should be provided.

Item g: NV Energy recommends that this scope item be removed from the SAR Scope because we do not believe that compliance treatment for specific non-compliance violations is an appropriate element of a NERC Reliability Standard. We also believe that it is clear that all BES resources, regardless of type or technology, at a plant site should operate in line with the frequency and voltage requirements as set forth in this Reliability Standard (i.e., do

not trip within the “No Trip” zone), unless there are known regulatory or equipment limitations. In those cases, the equipment limitations are to be reported to the Planning Coordinator and Transmission Coordinator per Requirement R3. For this reason, we do not believe that this scope item is needed. The SDT may decide that implementation guidance may be appropriate to help address compliance questions; however, we do not believe that Implementation Guidance should be a SAR Scope item because it is understood that this is an option for all SDTs.

Likes 0

Dislikes 0

Response

Aaron Cavanaugh - Bonneville Power Administration - 1,3,5,6 - WECC

Answer

Yes

Document Name

Comment

None

Likes 0

Dislikes 0

Response

Leonard Kula - Independent Electricity System Operator - 2

Answer

Yes

Document Name

Comment

The IESO supports the clarifications proposed in the SAR

Likes 0

Dislikes 0

Response

Sandra Shaffer - Berkshire Hathaway - PacifiCorp - 6

Answer

Yes

Document Name

Comment

PacifiCorp supports the SAR, as it pertains to GOs only.

Likes 0

Dislikes 0

Response

Tara Lightner - Sunflower Electric Power Corporation - 1 - MRO

Answer

Yes

Document Name

Comment

We agree with the scope as long as it is implemented properly. The SAR primarily addresses inverter-based resources, but we are assuming that most of the scope would logically extend to all generators.

Likes 0

Dislikes 0

Response

Thomas Breene - WEC Energy Group, Inc. - 3,4,5,6

Answer

Yes

Document Name

Comment

WEC Energy Group Comment: WEC Agrees. STD should consider adding example calculations to recently published Implementation Guidance: *PRC-024-2 R2 Generator Voltage Protective Relay Settings*

Likes 0

Dislikes 0

Response

Jodirah Green - ACES Power Marketing - 6, Group Name ACES Standard Collaborations

Answer

Yes

Document Name

Comment

We agree that system events, including the Blue Cut and Canyon 2 fires in California have emphasized the likelihood that certain requirements of PRC-024-2 are being misinterpreted ,thus putting the Bulk Electric System at risk. As such, the project scope is appropriate.

Likes 0

Dislikes 0

Response

Amy Casuscelli - Xcel Energy, Inc. - 1,3,5,6 - MRO,WECC

Answer

Yes

Document Name

Comment

While Xcel Energy generally supports the scope outlined in the SAR, we do have some concern regarding applicability to our traditional equipment.

Page 5 of the Gaps White paper states: "Similarly, frequency trip settings for generation resources should be set as wide as possible while still ensuring equipment protection and personnel safety to support BPS reliability. This aligns with the intent of PRC- 024-2. One possible solution could be to change the requirement such that relay settings be set based on equipment limitations but no narrower than the "No-Trip" zones."

In regards to this statement, we do not have unit-specific frequency limits or unit-specific V/Hz damage curves in some instances. We have generally set our relays per long-standing, general OEM recommendation or by coordinating with equipment type and typical V/Hz damage curves provided by IEEE, EPRI, CIGRE, etc. Our concern if this is changed in the standard, is use of general OEM recommendations and industry typical equipment damage curves and if this would be sufficient to show compliance/due diligence with setting relays "as wide as possible". We would like to make sure that none of the recommended changes for inverter-based generation would be detrimental to conventional generators or inconsistent with the burdens placed on conventional generators by the standard.

Likes 0

Dislikes 0

Response

Maryanne Darling-Reich - Black Hills Corporation - 1,3,5,6 - WECC

Answer

Yes

Document Name

Comment

Likes 0

Dislikes 0

Response

Mike Smith - Manitoba Hydro - 1,3,5,6, Group Name Manitoba Hydro

Answer Yes

Document Name

Comment

Likes 0

Dislikes 0

Response

Anton Vu - Los Angeles Department of Water and Power - 1,3,5,6

Answer Yes

Document Name

Comment

Likes 0

Dislikes 0

Response

Karie Barczak - DTE Energy - Detroit Edison Company - 3,4,5, Group Name DTE Energy - DTE Electric

Answer Yes

Document Name

Comment

Likes 0

Dislikes 0

Response

Thomas Foltz - AEP - 3,5

Answer Yes

Document Name

Comment

Likes 0

Dislikes 0

Response

Teresa Cantwell - Lower Colorado River Authority - 1,5

Answer

Yes

Document Name

Comment

Likes 0

Dislikes 0

Response

Matthew Lewis - Lower Colorado River Authority - 1,5

Answer

Yes

Document Name

Comment

Likes 0

Dislikes 0

Response

Brandon McCormick - Florida Municipal Power Agency - 3,4,5,6 - FRCC, Group Name FMPA

Answer

Yes

Document Name

Comment

Likes 0

Dislikes 0

Response

Richard Jackson - U.S. Bureau of Reclamation - 1,5

Answer	Yes
Document Name	
Comment	
Likes 0	
Dislikes 0	
Response	
Ruth Miller - Exelon - 1,3,5,6	
Answer	Yes
Document Name	
Comment	
Likes 0	
Dislikes 0	
Response	
Junji Yamaguchi - Hydro-Qu?bec Production - 1,5	
Answer	Yes
Document Name	
Comment	
Likes 0	
Dislikes 0	
Response	
Nicolas Turcotte - Hydro-Qu?bec TransEnergie - 1	
Answer	Yes
Document Name	
Comment	
Likes 0	

Dislikes 0

Response

Constantin Chitescu - Ontario Power Generation Inc. - 5

Answer Yes

Document Name

Comment

Likes 0

Dislikes 0

Response

Jesus Sammy Alcaraz - Imperial Irrigation District - 1,3,5,6

Answer Yes

Document Name

Comment

Likes 0

Dislikes 0

Response

Rachel Coyne - Texas Reliability Entity, Inc. - 10

Answer

Document Name

Comment

The SAR appears to address the majority of the solar inverter issues observed in the Blue Cut and Canyon 2 disturbances. The SAR does not, however, appear to address specific issues observed with voltage ride-through tolerances of wind generation that have been observed in ERCOT. One specific issue that has been observed in ERCOT, as well as the 2016 South Australia blackout, is wind turbine voltage ride through settings for multiple disturbances. Turbine manufacturers will set their voltage ride-through settings to disconnect or reduce turbine output if a specified number of voltage disturbances occur within a given time frame, even if the individual disturbances are within the ride-through curve. This issue was documented by NERC Events Analysis in Lesson Learned LL20170701. Technical issue #6 on page 6 of the SAR may also need to be expanded to include other types of voltage and frequency control systems within a wind turbine, specifically “smart crowbar” protective functions which can trip a turbine during transient voltage conditions. Texas RE requests the SAR include these issues.

Likes 0

Dislikes 0

Response

2. Do you agree with the Detailed Description section of the SAR? If you do not agree, or if you agree but have comments or suggestions, provide your recommendation or proposed modification below:

Kevin Salisbury - Berkshire Hathaway - NV Energy - 5

Answer No

Document Name

Comment

NV Energy submits the following as itemized comments to the SAR's Detailed Description:

Item 1: While NV Energy agrees that the region outside of the "No Trip" zone should not be interpreted as a must trip zone, we do not think that the SAR should predetermine what this region should be called and agree that the SDT should be given latitude to determine how best to address this concern. We are also concerned with the heavy emphasis on one type of resource (i.e., IBRs) within the SAR rather than addressing ambiguities affecting all resources and resource owners currently contained within PRC-024-2. While we understand the current concerns relate to IBRs, trying to resolve all misunderstandings by technology type within a Reliability Standard is not consistent with a technology neutral approach. We support the statements made by the Essential Reliability Task Force that recognized "that ERSs are technology neutral and must be provided regardless of the resource mix composition for a given operating area or Balancing Area (BA)." (see ERSTF – Concept Paper on ERS that Characterizes BPS Reliability | October 2014, page vi). From this perspective, we believe that PRC-024 should address current concerns and ambiguities broadly without focusing on specific technologies but be inclusive of considerations for IBRs.

Item 2: While NV Energy agrees that frequency cannot and should not be measured or calculated using instantaneously sampled values, clarifications may be useful to manufacturers who have less familiarity with the methods used by the industry to measure frequency. Additionally, while adding clarification may be useful, we suggest care be given to ensure those clarifications being considered do not extend into areas that might be better suited to guidelines and technical standards (such as produced by the IEEE) rather than what would be appropriate to a Reliability Standard. Moreover, issues related to this concern, as described in the Blue Cut Fire Report, were resolved by IBR manufacturers and the industry as a result of the NERC Alerts and confirmed by the Canyon 2 Report. (see our comments to Question 1, Item b)

Item 3, 4 and 5: NV Energy agrees and supports the detailed descriptions contained in these items.

Item 6: NV Energy agrees with the IRPTF that there is ambiguity related to whether IBRs are required to comply with PRC-024-2. We believe that the uncertainty is due to language contained within this Reliability Standard that only requires compliance from generator frequency and voltage protective relays and does not specifically address whether these functions embedded or emulated within generator control systems would also be required to comply with this Reliability Standard. We also agree that Footnote 1 does not clarify that protection functions contained within generator control systems are considered part of this standard. Footnote 1 simply states that GOs are not required to have frequency or voltage protective relaying installed or activated on their units. NV Energy supports clarifications to the standard to ensure that protection functions provided through other mechanisms, such as resource control systems, should be required to comply with the PRC-024 Reliability Standard. We encourage NERC and the SDT to ensure that newly added language is not technology specific and broadly addresses the reliability needs of the BES.

Likes 0

Dislikes 0

Response

Pamela Hunter - Southern Company - Southern Company Services, Inc. - 1,3,5,6 - SERC, Group Name Southern Company

Answer No

Document Name

Comment

The same comments to question #1 apply here.

Likes 0

Dislikes 0

Response

Charles Yeung - Southwest Power Pool, Inc. (RTO) - 2

Answer No

Document Name

Comment

The industry needs a wide and open process to substantiate the findings and confirm the solutions offered in the details of the SAR. This SAR and the NERC standards process is the first time such an open process is being offered to confirm the findings and proposed “fixes” of the IRPTF and the details in the SAR should not be interpreted as the “boundaries” of what the SDT can propose.

The PRC-024-2 Gaps White Paper is a very well written description and background reference to the problems which arose from the Blue Cut Fire and the Canyon 2 events which propelled the need for this SAR. The Detailed Description of the SAR captures what the IRPTF perceives are some of the needed clarifications to existing requirements and additional requirements to address problems exemplified from the forensic analysis of those two events. However, the SRC asks that the SAR not restrict the SDT from offering alternative solutions to what is proposed in the details of the SAR and in the GAPS whitepaper.

As one example, the standard could be revised to completely prohibit momentary cessation in the ‘No Trip’ zone for inverters not yet installed (for newer equipment which meet the new IEEE 1547 requirements). To address older inverters already installed, momentary cessation can be used in the ‘No Trip’ zone is, if that equipment has been reported as an equipment limitation as per Requirement R3.

Similar to the comment in the scope section, Bullet #1 in the description should be revised to indicate that the region outside the trip curve should reflect equipment limitations and not simply be a “May Trip” zone. Generators should provide grid support until equipment limitations are reached.

Please consider rewording the details contained in the SAR to allow for the problems to be addressed but not be read as the “only” way the issue can be addressed by the SDT.

Likes 0

Dislikes 0

Response

Devin Shines - PPL - Louisville Gas and Electric Co. - 3,5,6 - SERC, Group Name Louisville Gas and Electric Company and Kentucky Utilities Company

Answer

No

Document Name

Comment

Louisville Gas and Electric Company and Kentucky Utilities Company (LG&E/KU) supports the comments submitted by the Edison Electric Institute (EEI).

Likes 0

Dislikes 0

Response

Mark Gray - Edison Electric Institute - NA - Not Applicable - NA - Not Applicable

Answer

No

Document Name

Comment

Item 1: While EEI agrees that the region outside of the “No Trip” zone should not be interpreted as a must trip zone, we do not think that the SAR should predetermine what this region should be called and agree that the SDT should be given latitude to determine how best to address this concern. We are also concerned with the heavy emphasis on one type of resource (i.e., IBRs) within the SAR rather than addressing ambiguities affecting all resources and resource owners currently contained within PRC-024-2. While we understand the current concerns relate to IBRs, trying to resolve all misunderstandings by technology type within a Reliability Standard is not consistent with a technology neutral approach. We support the statements made by the Essential Reliability Task Force that recognized “that ERSs are technology neutral and must be provided regardless of the resource mix composition for a given operating area or Balancing Area (BA).” (see ERSTF – Concept Paper on ERS that Characterizes BPS Reliability | October 2014, page vi). From this perspective, we believe that PRC-024 should address current concerns and ambiguities broadly without focusing on specific technologies but be inclusive of considerations for IBRs.

Item 2: While EEI agrees that frequency cannot and should not be measured or calculated using instantaneously sampled values, clarifications may be useful to manufacturers who have less familiarity with the methods used by the industry to measure frequency. Additionally, while adding clarification may be useful, we suggest care be given to ensure those clarifications being considered do not extend into areas that might be better suited to guidelines and technical standards (such as produced by the IEEE) rather than what would be appropriate to a Reliability Standard. Moreover, issues related to this concern, as described in the Blue Cut Fire Report, were resolved by IBR manufacturers and the industry as a result of the NERC Alerts and confirmed by the Canyon 2 Report. (see our comments to Question 1, Item b)

Item 3, 4 and 5: EEI agrees and supports the detailed descriptions contained in these items.

Item 6: EEI agrees with the IRPTF that there is ambiguity related to whether IBRs are required to comply with PRC-024-2. We believe that the uncertainty is due to language contained within this Reliability Standard that only requires compliance from generator frequency and voltage protective

relays and does not specifically address these functions embedded or emulated within generator control systems would also be required to comply with this Reliability Standard. We also agree that Footnote 1 does not clarify that protection functions contained within generator control systems are considered part of this standard. Footnote 1 simply states that GOs are not required to have frequency or voltage protective relaying installed or activated on their units. EEI supports clarifications to the standard to ensure that protection functions provided through other mechanisms, such as resource control systems, should be required to comply with the PRC-024 Reliability Standard. We encourage NERC and the SDT to ensure that newly added language is not technology specific and broadly addresses the reliability needs of the BES.

Item 7: See EEI Comments to Items f and g under question 1 above.

Likes 0

Dislikes 0

Response

Douglas Webb - Great Plains Energy - Kansas City Power and Light Co. - 1,3,5,6 - MRO, Group Name Westar-KCPL

Answer

No

Document Name

Comment

EEI submitted the following as itemized comments to the SAR's Detailed Description. The Company's response is offered in a like manner

Item 1: The Company agrees the region outside of the "No Trip" zone requires clarity; however, a SAR should not establish predetermined outcomes for the SDT. The SDT, by design, requires latitude to determine how best to address this concern. The Company believes that a broad approach or consideration for many technologies will strengthen grid operations and avoid missing a specific type of resource, but ensure inclusion of Inverter Based Resources.

The Company understands the current concerns related to IBRs, however, it holds a view that resolution of emerging issues by technology type within a Reliability Standard is not a sustainable path for the future for NERC or the industry.

The Company agrees with EEI's highlighting of the work from the Essential Reliability Task Force that recognized "...ERSs are technology neutral and must be provided regardless of the resource mix composition for a given operating area or Balancing Area (BA)." (see ERSTF – Concept Paper on ERS that Characterizes BPS Reliability | October 2014, page vi) From this perspective, PRC-024 revisions will be more effective in strengthening reliability and resilience by addressing clarifications in a broad fashion without focusing on specific technologies.

Item 2: The Company endorses EEI's comments.

Item 3, 4 and 5: The Company endorses EEI's comments.

Item 6: The Company endorses EEI's comments.

Item 7: Please see the Company's comments on items f and g.

Likes 0

Dislikes 0

Response

Ruida Shu - Northeast Power Coordinating Council - 1,2,3,4,5,6,7,8,9,10 - NPCC, Group Name RSC no Dominion

Answer No

Document Name

Comment

Reliability Standards should be technology neutral. The detailed description should be limited to removing ambiguity from the standard. Technical Rationale documents and/or compliance Implementation Guidance documents could be written if the drafting team determines that further explanation is needed for inverter-based generation.

We propose the following clarifications be added to the detailed description of the SAR:

The Generator Owner and/or manufacturer of the equipment should convert their phase voltage measurements to positive-sequence values. We propose that the term 'positive-sequence' be added as follows:

"If RMS, clarify that the RMS signal pertains to positive-sequence to the fundamental frequency RMS signal rather than the true RMS signal.

It is not clear what is meant by start, stop, and reset under Item 5 on page 5 of SAR. Please clarify what is meant by each position.

The region outside the trip curve should reflect equipment limitations only and not simply be a "May Trip" zone. Generators should provide grid support during disturbances until equipment limitations are reached. We propose that the detailed description clarifies that for inverters not yet installed, momentary cessation should be completely prohibited in the 'No Trip' zone. For inverters already installed, the only time momentary cessation can be used in the 'No Trip' zone is, if it has been reported as an equipment limitation as per Requirement R3.

Likes 0

Dislikes 0

Response

Douglas Johnson - American Transmission Company, LLC - 1

Answer No

Document Name

Comment

American Transmission Company LLC (ATC) supports and endorses the comments submitted by the Edison Electric Institute (EEI) on behalf of the EEI member companies.

Likes 0

Dislikes 0

Response

Tamara Evey - Ameren - Ameren Services - 1,3,5,7 - SERC

Answer	No
Document Name	
Comment	
Ameren agrees with and supports EEI comments for question #2.	
Likes 0	
Dislikes 0	
Response	
Thomas Breene - WEC Energy Group, Inc. - 3,4,5,6	
Answer	No
Document Name	
Comment	
<p>3. Point #5 in the Curve Details section of the “Voltage Ride-Through Curve Clarifications” (page 11 of PRC-024-2) states, “voltages in the curve assume minimum fundamental frequency phase to ground or phase to phase voltage for the low duration curve and the greater of maximum RMS (Root Mean Square) or crest phase to phase voltage for the high voltage duration curve.” There are a number of ways this can be interpreted, and issues that need to be addressed.</p> <ul style="list-style-type: none"> To minimize the probability of incorrect tripping (as noted in point 2 above), any voltage compared with the PRC-024-2 voltage ride through curves should be a well-filtered, fundamental frequency component of the voltage waveform. This will filter out spurious voltage spikes caused by switching action on the BPS. Voltage protective relays should not operate at the voltage levels specified in the voltage ride-through curve using instantaneously sampled values. The clarification should focus on using the RMS value of the voltage, and that the voltage signal should be adequately filtered to obtain this fundamental component. <p>WEC Energy Group Comment: WEC Disagrees. Consider the impact of this requirement on electromechanical protective relays as they have no filtering capabilities.</p>	
Likes 0	
Dislikes 0	
Response	
Tara Lightner - Sunflower Electric Power Corporation - 1 - MRO	
Answer	No
Document Name	
Comment	

We generally agree with the detailed description. However, there appears to be some overreach or ambiguity in the way some of the detailed descriptions are written, and care must be taken to not overstep the intent of the standard.

1. OK with adding “May Trip” labels to the curves. However, the description states: *“This will enhance reliability since the generator owner, operator, developer, and equipment manufacturer will understand that the inverter protective trip settings should be based on equipment capability...”* We believe that a lot of legacy generators use settings based on “best industry practices” and not necessarily actual generator capability, and any requirement or even implication that these must be set based on generator capability could result in excessive burden attempting to determine what the actual settings should be and we believe this is outside the scope of this standard.
2. OK with adding requirement for filtering to determine frequency. Filter time needs to be a reasonable value based on industry practices or “expert” recommendations.
3. Generally supportive of clarifications. Filter time needs to be a reasonable value based on industry practices or “expert” recommendations.
4. Support using the nominal BES voltage at the point of interconnection.
5. Supportive of clarifications.
6. Supportive that standard should clearly state applicability to individual inverters encompassing both protective relay functions and control functions.
7. Supportive that clarification of the use of momentary cessation within the “No Trip” zone is in violation of the standard.

Likes 0

Dislikes 0

Response

Richard Vine - California ISO - 2

Answer

No

Document Name

Comment

The California ISO supports the comments of the ISO/RTO Council Standards Review Committee (SRC)

Likes 0

Dislikes 0

Response

Sean Bodkin - Dominion - Dominion Resources, Inc. - 3,5,6, Group Name Dominion

Answer

No

Document Name

Comment

Dominion Energy supports the comments of EEI regarding the details of the items included in the current SAR that should be removed from scope.

Likes 0

Dislikes 0

Response

Jodirah Green - ACES Power Marketing - 6, Group Name ACES Standard Collaborations

Answer

Yes

Document Name

Comment

We agree that the deliverables outlined in the Detailed Description section support the identified Project Scope. While inverter based resources appear to be the primary focus for the revisions, we request that the potential for scope creep be closely monitored as it relates to Item 1 in the detailed description. Specifically, the language noting that inverter protective trip settings should be based on equipment capability is cause for concern. It would be overly burdensome if this issue results in traditional generation needing to conduct capability testing or produce studies to demonstrate that their trip settings are based on equipment capability.

Likes 0

Dislikes 0

Response

Leonard Kula - Independent Electricity System Operator - 2

Answer

Yes

Document Name

Comment

We propose the following clarifications be added to the detailed description of the SAR:

- The Generator Owner and/or manufacturer of the equipment should convert their phase voltage measurements to positive-sequence values. We propose that the term 'positive-sequence' be added as follows:

“ If RMS, clarify that the RMS signal pertains to positive-sequence to the fundamental frequency RMS signal rather than the true RMS signal.

- It is not clear what is meant by start, stop, and reset under Item 5 on page 5 of SAR. Please clarify what is meant by each position.

- The region outside the trip curve should reflect equipment limitations only and not simply be a "May Trip" zone. Generators should provide grid support during disturbances until equipment limitations are reached. We propose that the detailed description clarifies that for inverters not yet installed, momentary cessation should be completely prohibited in the 'No Trip' zone. For inverters already installed, the only time momentary cessation can be used in the 'No Trip' zone is, if it has been reported as an equipment limitation as per Requirement R3.

Likes 0

Dislikes 0

Response

Aaron Cavanaugh - Bonneville Power Administration - 1,3,5,6 - WECC

Answer

Yes

Document Name

Comment

Per the many discussions surrounding PRC-024 that were brought up last year, BPA is happy to see that the SAR has finally been submitted. With the scope of this SAR, issues regarding the voltage relay operating at the voltage levels in the voltage ride-through will not occur.

Likes 0

Dislikes 0

Response

Jesus Sammy Alcaraz - Imperial Irrigation District - 1,3,5,6

Answer

Yes

Document Name

Comment

Likes 0

Dislikes 0

Response

Constantin Chitescu - Ontario Power Generation Inc. - 5

Answer

Yes

Document Name

Comment

Likes 0

Dislikes 0

Response

Amy Casuscelli - Xcel Energy, Inc. - 1,3,5,6 - MRO,WECC

Answer

Yes

Document Name

Comment

Likes 0

Dislikes 0

Response

Nicolas Turcotte - Hydro-Qu?bec TransEnergie - 1

Answer

Yes

Document Name

Comment

Likes 0

Dislikes 0

Response

Junji Yamaguchi - Hydro-Qu?bec Production - 1,5

Answer

Yes

Document Name

Comment

Likes 0

Dislikes 0

Response

Ruth Miller - Exelon - 1,3,5,6

Answer	Yes
Document Name	
Comment	
Likes 0	
Dislikes 0	
Response	
Richard Jackson - U.S. Bureau of Reclamation - 1,5	
Answer	Yes
Document Name	
Comment	
Likes 0	
Dislikes 0	
Response	
Brandon McCormick - Florida Municipal Power Agency - 3,4,5,6 - FRCC, Group Name FMPA	
Answer	Yes
Document Name	
Comment	
Likes 0	
Dislikes 0	
Response	
Matthew Lewis - Lower Colorado River Authority - 1,5	
Answer	Yes
Document Name	
Comment	
Likes 0	

Dislikes 0

Response

Teresa Cantwell - Lower Colorado River Authority - 1,5

Answer

Yes

Document Name

Comment

Likes 0

Dislikes 0

Response

Dana Klem - MRO - 1,2,3,4,5,6 - MRO, Group Name MRO NSRF

Answer

Yes

Document Name

Comment

Likes 0

Dislikes 0

Response

Thomas Foltz - AEP - 3,5

Answer

Yes

Document Name

Comment

Likes 0

Dislikes 0

Response

Karie Barczak - DTE Energy - Detroit Edison Company - 3,4,5, Group Name DTE Energy - DTE Electric

Answer

Yes

Document Name	
Comment	
Likes 0	
Dislikes 0	
Response	
Anton Vu - Los Angeles Department of Water and Power - 1,3,5,6	
Answer	Yes
Document Name	
Comment	
Likes 0	
Dislikes 0	
Response	
Rachel Coyne - Texas Reliability Entity, Inc. - 10	
Answer	Yes
Document Name	
Comment	
Likes 0	
Dislikes 0	
Response	
Mike Smith - Manitoba Hydro - 1,3,5,6, Group Name Manitoba Hydro	
Answer	Yes
Document Name	
Comment	
Likes 0	
Dislikes 0	

Response	
Maryanne Darling-Reich - Black Hills Corporation - 1,3,5,6 - WECC	
Answer	Yes
Document Name	
Comment	
Likes 0	
Dislikes 0	
Response	

3. If you have any other comments on this SAR that you haven't already mentioned above, provide them here:

Maryanne Darling-Reich - Black Hills Corporation - 1,3,5,6 - WECC

Answer

Document Name

Comment

Although at this time, BHC does not have inverter-based resources within its generation fleet; some of the other gaps identified do pertain to BHC and we look forward to the clarifications that this SAR could provide.

Likes 0

Dislikes 0

Response

Rachel Coyne - Texas Reliability Entity, Inc. - 10

Answer

Document Name

Comment

Texas RE does not have additional comments.

Likes 0

Dislikes 0

Response

Karie Barczak - DTE Energy - Detroit Edison Company - 3,4,5, Group Name DTE Energy - DTE Electric

Answer

Document Name

Comment

We are in support of NERC and the industry addressing the ambiguities, inconsistencies, and technical errors as identified in this SAR.

Likes 0

Dislikes 0

Response

Aaron Cavanaugh - Bonneville Power Administration - 1,3,5,6 - WECC

Answer

Document Name

Comment

BPA believes that this SAR will further clarify some of the peculiar language posed in several areas. BPA is in full support of this SAR.

Likes 0

Dislikes 0

Response

Leonard Kula - Independent Electricity System Operator - 2

Answer

Document Name

Comment

The SAR should not restrict the SDT from offering alternative solutions to what is proposed in the details of the SAR and in the GAPS whitepaper. An alternative solution for consideration would be to increase the ride-through time and have inverter-based units stay connected for longer periods. Please consider rewording the details contained in the SAR to allow for the problems to be addressed but not be read as the “only” way the issue can be addressed by the SDT.

Likes 0

Dislikes 0

Response

Dana Klem - MRO - 1,2,3,4,5,6 - MRO, Group Name MRO NSRF

Answer

Document Name

Comment

The NSRF understands this is applicable to Generator Owners but does not understand the opening statement of: “...equipment manufacturers clearly understand the intent of the standard, so their plants respond to grid disturbances in a manner that contributes to the reliable operation of the bulk power system “. This does not assure that all new inverter type devices (and currently in-service inverter devices) will come from the manufacture meeting the soon to be created criteria of the new PRC-024 Standard. The SAR should also contain what Entities should do if they cannot meet this Standard based on Manufacture guidance. The current PRC-024-2 R1, bullet three gives Entities guidance on this based on equipment limitations. The NSRF recommends that this statement is maintained within the updated PRC-024.

The NERC standard PRC-024 has a Standard Authorization Requirement (SAR) request that could change the scope of PRC-024 compliance. FERC, NERC, and the drafting team have identified a need to include converters / inverters in the new PRC-024 standard as a result of the Blue Cut Fire and

Canyon 2 disturbances in southern California. However, revised language must be carefully drafted to include only those low-voltage protective device settings that could have a measurable BES electrical impact in aggregate.

PRC-024 footnote 1 is unclear should be clarified to include only electrical protective devices and clearly exclude non-electrical protective devices. We recommend that this be added to the SAR, for review.

Plant Distributed Control Systems (DCS) [i.e., collector systems] should be clarified that they are not in-scope. DCS systems weren't clearly addressed in past NERC standards including PRC-005 and PRC-024. The BES definition, Inclusion, I4, part A and B is the only source that collector systems are not in-scope. The NSRF recommends that this be addressed and could be accomplished by a simple foot note.

The NSRF also recommends the last sentence in Item 1 of the Detailed Description be removed in order to avoid scope creep and ensure application of the standard as originally intended.

Likes 0

Dislikes 0

Response

Sean Bodkin - Dominion - Dominion Resources, Inc. - 3,5,6, Group Name Dominion

Answer

Document Name

Comment

Dominion Energy supports EEI comments and supports SARs and Reliability Standards that are technology neutral. Specific technologies, such as inverters, should not have specific mandatory requirements. Rather, Reliability Standards should be results based so that any equipment or technology that is used by an entity has the same requirements to meet the reliability objective.

Likes 0

Dislikes 0

Response

Richard Vine - California ISO - 2

Answer

Document Name

Comment

The California ISO supports the comments of the ISO/RTO Council Standards Review Committee (SRC)

Likes 0

Dislikes 0

Response

Teresa Cantwell - Lower Colorado River Authority - 1,5

Answer

Document Name

Comment

None.

Likes 0

Dislikes 0

Response

Matthew Lewis - Lower Colorado River Authority - 1,5

Answer

Document Name

Comment

None

Likes 0

Dislikes 0

Response

Thomas Breene - WEC Energy Group, Inc. - 3,4,5,6

Answer

Document Name

Comment

WEC Energy Group supports efforts to clean and clarify the standard and agrees that current standard language is synchronous generator-centric language. However, it is WEC's opinion that introducing terms that describe inverter's form of operation (e.g. momentary cessation, partial tripping, etc.) could potentially create more confusion in standard interpretation. Unless term applies to all dispersed power producing resources, it should be stated what type of dispersed power producing resources the term applies to.

Likes 0

Dislikes 0

Response

Tamara Evey - Ameren - Ameren Services - 1,3,5,7 - SERC

Answer

Document Name

Comment

Ameren agrees with and supports EEI comments for question #3.

Likes 0

Dislikes 0

Response

Ruth Miller - Exelon - 1,3,5,6

Answer

Document Name

Comment

Exelon Nuclear would like the SDT to clarify that PRC-024 is applicable only to generator frequency and generator voltage protective relays that respond to electrical quantities and directly or through lockout relays trip the generator. Footnote 1, or a different mechanism could be used to clarify that the voltage and frequency limits are not applicable to a generating plant's auxiliary equipment protection systems that could result in a generator trip (either directly or via tripping signals).

Likes 0

Dislikes 0

Response

Douglas Johnson - American Transmission Company, LLC - 1

Answer

Document Name

Comment

American Transmission Company LLC (ATC) supports and endorses the comments submitted by the Edison Electric Institute (EEI) on behalf of the EEI member companies.

Likes 0

Dislikes 0

Response

Ruida Shu - Northeast Power Coordinating Council - 1,2,3,4,5,6,7,8,9,10 - NPCC, Group Name RSC no Dominion

Answer

Document Name

Comment

The SAR should not restrict the SDT from offering alternative solutions to what is proposed in the details of the SAR and in the GAPS whitepaper. An alternative solution for consideration would be to increase the ride-through time and have inverter-based units stay connected for longer periods. Please consider rewording the details contained in the SAR to allow for the problems to be addressed but not be read as the “only” way the issue can be addressed by the SDT.

Likes 0

Dislikes 0

Response

Douglas Webb - Great Plains Energy - Kansas City Power and Light Co. - 1,3,5,6 - MRO, Group Name Westar-KCPL

Answer

Document Name

Comment

The Company endorses EEI's response to Question 3.

Likes 0

Dislikes 0

Response

Junji Yamaguchi - Hydro-Quebec Production - 1,5

Answer

Document Name

Comment

Hydro-Quebec has had an issue since 2009 with the LVRT curve. The technical requirements for the connection of generating stations to the Hydro-Quebec Transmission System (Grid Code), as adopted by the Regulator in Quebec, show a LVRT curve that is different from what PRC-024-2 requires (attachment 2). The LVRT requirement reflects the specific needs to ensure reliability of the Quebec Interconnection, taking into account the conventional and non-conventional generation. The LVRT curve was established in response to FERC Order No. 661-A issued on December 12, 2005, which considered the integration of wind generation. Thus, Hydro-Quebec requests to add this item into this SAR for PRC-024-2.

Likes 0

Dislikes 0

Response

Mark Gray - Edison Electric Institute - NA - Not Applicable - NA - Not Applicable

Answer

Document Name

Comment

EEI agrees that IBRs present new challenges that are specific to the manner and method by which they operate and support the BES. We believe that changes to the affected Reliability Standards can be accomplished in a manner that is technology neutral. From this perspective, we recommend that in efforts to improve the SAR, NERC consider avoiding language that may push the SDT into a direction that changes how Reliability Standards are written. We believe that the goal for PRC-024 modifications should be to ensure that resources, regardless of the type, operate in a manner that ensures all resources remain connected (within their technical limits) during defined frequency and voltage excursions regardless of how the resource protection functions are effectuated.

Likes 0

Dislikes 0

Response

Jodirah Green - ACES Power Marketing - 6, Group Name ACES Standard Collaborations

Answer

Document Name

Comment

In finalizing the SAR, consider benefits to clarity of including a discussion of the frequency bands associated with other NERC standards, for example PRC-006-3 R3. The PRC-006-3 requirement includes a frequency bandwidth less than 60.7 and greater than 59.3 (Eastern Interconnection), while PRC-024 includes a continuous operation bandwidth greater than 59.5 and less than 60.5 (Eastern Interconnection). Although the bandwidths associated with the two standards may address different underlying concerns, clarifying language in PRC-024, could eliminate confusion across the industry with regards to the differences.

The SAR may also want to consider potential impacts on traditional generation (as opposed to solar, wind, battery storage, etc.), if the requirements of PRC-024 are revised to be overly specific.

Likes 0

Dislikes 0

Response

Nicolas Turcotte - Hydro-Qu?bec TransEnergie - 1

Answer

Document Name	
Comment	
Hydro-Quebec has had an issue since 2009 with the LVRT curve. The LVRT requirement specific to Quebec reflects the specific needs to ensure reliability of the Quebec Interconnection, taking into account the conventional and non-conventional generation and whether or not the generating facilities are connected or not to the main transmission system. This situation is problematic for the Transmission Owner at Hydro-Quebec therefore, Hydro-Quebec requests to add this item into this SAR for PRC-024-2.	
Likes	0
Dislikes	0
Response	
Devin Shines - PPL - Louisville Gas and Electric Co. - 3,5,6 - SERC, Group Name Louisville Gas and Electric Company and Kentucky Utilities Company	
Answer	
Document Name	
Comment	
Louisville Gas and Electric Company and Kentucky Utilities Company (LG&E/KU) supports the comments submitted by the Edison Electric Institute (EEI). Additionally, LG&E/KU have comments on the proposed revisions to PRC-024-2 as set forth below.	
<p>LG&E/KU believes the proposed revisions to PRC-024-2 may be unnecessary for a number of reasons.</p> <ul style="list-style-type: none"> First, viewed from a broad policy perspective, this SAR appears reactionary to events that produced issues in a single, particular region. The Project Background states that the issues at hand were identified by the Inverter-Based Resource Performance Task Force (IRPTF) while analyzing the Blue Cut and Canyon 2 fires in southern California. <p>NERC summarizes the purpose and characteristics of Regional Reliability Standards on its own website, saying: “Regional Reliability Standards shall provide for as much uniformity as possible relative to NERC Reliability Standards across the interconnected bulk power system of the North American continent. A regional Reliability Standard shall be more stringent than a continent-wide Reliability Standard, including a regional difference that addresses matters that the continent wide Reliability Standard does not, or shall be a regional difference necessitated by a physical difference in the bulk power system.”</p> <p>The results of wildfires are inarguably devastating, and the investigations and analyses that contribute to ensuring Reliability during these instances are inherently valuable. However, we believe that the issues the IRPTF identified as problematic may be more effectively addressed within that region specifically, rather than applying what may be inapplicable or unnecessary requirements to the industry as a whole. LG&E/KU suggest NERC carefully consider whether or which potential revisions to PRC-024-2 are properly industry-wide, rather than targeted for regional needs.</p> <ul style="list-style-type: none"> Second, as detailed by EEI’s comments, we believe that points included in the SAR Scope requesting clarification are unnecessary due to Implementation Guidance recently endorsed by NERC on January 3, 2019. Further clarification of Requirement R2 should be unnecessary given the timeliness of the recent guidance. 	
Likes	0

Dislikes 0

Response

Kevin Salsbury - Berkshire Hathaway - NV Energy - 5

Answer

Document Name

Comment

NV Energy agrees that IBRs present new challenges that are specific to the manner and method by which they operate and support the BES. We believe that changes to the affected Reliability Standards can be accomplished in a manner that is technology neutral. From this perspective, we recommend that in efforts to improve the SAR, NERC consider avoiding language that may push the SDT into a direction that changes how Reliability Standards are written. We believe that the goal for PRC-024 modifications should be to ensure that resources, regardless of the type, operate in a manner that ensures all resources remain connected (within their technical limits) during defined frequency and voltage excursions regardless of how the resource protection functions are effectuated.

Likes 0

Dislikes 0

Response

Comment/Theme/Summary	Response
<p>The SDT should also consider making this minimum time delay greater than 0.1 sec. A suggested minimum time delay around 0.5 to 1.0 seconds would be more appropriate. This will allow for better ride-through of somewhat prolonged, slower swings. It will also better coordinate with the minimum time delay for UFLS actuation. (At least in SERC, a minimum time delay of 6 cycles [0.1 sec] is required per UFLS standard PRC-006-SERC-02.) A longer time delay in the suggested range will have no adverse impact on system operation or equipment damage.</p>	<p>Disposition: the SDT has the discretion to modify the standard in the manner to cover this comment. Making the proposed changes to the SAR is not necessary and could potentially be overly prescriptive.</p>
<p>RMS should be used as a practical matter in terms of the typical instrumentation available for calibration of the equipment involved. We would also suggest that distinguishing between “fundamental frequency RMS” and “True RMS” (i.e. all frequency components) is unnecessary from a practical perspective. In the vast majority of cases, fundamental frequency is the very dominant component. Recognizing that inverters themselves can create a significant level of harmonics, if this is considered by the SDT as important, the ride-through value(s) selected for the curves/equations should be modified to accommodate either without the need to make special instrument accommodations to determine one or the other.</p>	<p>Disposition: the SDT has the discretion to modify the standard in the manner to cover this comment. Making the proposed changes to the SAR is not necessary and could potentially be overly prescriptive.</p>
<p>· The Generator Owner and/or manufacturer of the equipment should convert their phase voltage measurements to positive-sequence values. We propose that the term ‘positive-sequence’ be added as follows: “ If RMS, clarify that the RMS signal pertains to positive-sequence to the fundamental frequency RMS signal rather than the true RMS signal.</p>	<p>Disposition: the SDT has the discretion to modify the standard in the manner to cover this comment. Making the proposed changes to the SAR is not necessary and could potentially be overly prescriptive.</p>
<p>The use of momentary cessation within the “No Trip” zone of PRC-024-2 should be disallowed. If it happens, it should be reported as an equipment limitation per Requirement R3. Since the momentary cessation is an integral part of the basic inverter design, the SDT should consider working with the NERC Inverter-Based Resource Performance Task Force (IRPTF) to incorporate some explanation in PRC-024 regarding the different considerations for inverter-based generation resources as compared to synchronous generation resources. The Rationale section of PRC-024 might be a good place for such explanation.</p>	<p>Disposition: the SDT has the discretion to modify the standard in the manner to cover this comment. Making the proposed changes to the SAR is not necessary and could potentially be overly prescriptive.</p>
<p>Reliability standards should be technology neutral. The project scope should be limited to removing ambiguity from the standard. Technical Rationale documents and/or Compliance Implementation Guidance documents could be written if the drafting team determines that further explanation is needed for inverter-based generation.</p>	<p>SAR as written provides the SDT the latitude necessary to encompass all existing and future technologies. I agree with the commenter that the SDT can author other documents such as Implementation Guidance to provide more specific details regarding specific technologies (IBR and older wind turbines).</p>
<p>revisions to PRC-024 should accommodate a wide view when considering Inverter Based Resources (IBR), and take care not to consider IBRs singularly within a narrow focus, which may inadvertently omit something with an equally large system impact.</p>	<p>SAR as written provides the SDT the latitude necessary to encompass all existing and future technologies. I agree with the commenter that the SDT can author other documents such as Implementation Guidance to provide more specific details regarding specific technologies (IBR and older wind turbines).</p>

<p>The SAR appears to address the majority of the solar inverter issues observed in the Blue Cut and Canyon 2 disturbances. The SAR does not, however, appear to address specific issues observed with voltage ride-through tolerances of wind generation that have been observed in ERCOT. One specific issue that has been observed in ERCOT, as well as the 2016 South Australia blackout, is wind turbine voltage ride through settings for multiple disturbances. Turbine manufacturers will set their voltage ride-through settings to disconnect or reduce turbine output if a specified number of voltage disturbances occur within a given time frame, even if the individual disturbances are within the ride-through curve. This issue was documented by NERC Events Analysis in Lesson Learned LL20170701.</p>	<p>IRPTF discussed the multiple ride-through issue, and the start, stop, reset clarification is the attempt to address. Addressed in detailed description, Item 5 - SAR modified accordingly.</p>
<p>The SAR should not restrict the SDT from offering alternative solutions to what is proposed in the details of the SAR and in the GAPS whitepaper. An alternative solution for consideration would be to increase the ride-through time and have inverter-based units stay connected for longer periods. Please consider rewording the details contained in the SAR to allow for the problems to be addressed but not be read as the “only” way the issue can be addressed by the SDT.</p>	<p>Disposition: the SDT has the discretion to modify the standard in the manner to cover this comment. Making the proposed changes to the SAR would be additionally prescriptive.</p>
<p>The NSRF understands this is applicable to Generator Owners but does not understand the opening statement of: “...equipment manufacturers clearly understand the intent of the standard, so their plants respond to grid disturbances in a manner that contributes to the reliable operation of the bulk power system “. This does not assure that all new inverter type devices (and currently in-service inverter devices) will come from the manufacture meeting the soon to be created criteria of the new PRC-024 Standard. The SAR should also contain what Entities should do if they cannot meet this Standard based on Manufacture guidance. The current PRC-024-2 R1, bullet three gives Entities guidance on this based on equipment limitations. The NSRF recommends that this statement is maintained within the updated PRC-024.</p>	<p>No change to the SAR is required. The sentence the NSRF references is from the Reliability Guideline. The standard is already applicable to GOs and already addresses what the GO should do in the circumstance described. The NSRF is asking that this statement be maintained as-is in the revised standard. The SDT should have the latitude to change the language if it can be improved or leave as-is.</p>
<p>PRC-024 footnote 1 is unclear should be clarified to include only electrical protective devices and clearly exclude non-electrical protective devices. We recommend that this be added to the SAR, for review.</p> <p>Plant Distributed Control Systems (DCS) [i.e., collector systems] should be clarified that they are not in-scope. DCS systems weren’t clearly addressed in past NERC standards including PRC-005 and PRC-024. The BES definition, Inclusion, I4, part A and B is the only source that collector systems are not in-scope. The NSRF recommends that this be addressed and could be accomplished by a simple foot note.</p>	<p>No changes to the SAR - BES definition adequately addresses this issue.</p>

<p>WEC Energy Group supports efforts to clean and clarify the standard and agrees that current standard language is synchronous generator-centric language. However, it is WEC's opinion that introducing terms that describe inverter's form of operation (e.g. momentary cessation, partial tripping, etc.) could potentially create more confusion in standard interpretation. Unless term applies to all dispersed power producing resources, it should be stated what type of dispersed power producing resources the term applies to.</p>	<p>RecomDisposition: mendation: the SDT may propose defined terms during drafting if necessary; therefore, it is not necessary element of the SAR</p>
<p>Exelon Nuclear would like the SDT to clarify that PRC-024 is applicable only to generator frequency and generator voltage protective relays that respond to electrical quantities and directly or through lockout relays trip the generator. Footnote 1, or a different mechanism could be used to clarify that the voltage and frequency limits are not applicable to a generating plant's auxiliary equipment protection systems that could result in a generator trip (either directly or via tripping signals).</p>	<p>The issue raised does not accomplish the objective of the SAR's intent.</p>
<p>Hydro-Quebec has had an issue since 2009 with the LVRT curve. The technical requirements for the connection of generating stations to the Hydro-Quebec Transmission System (Grid Code), as adopted by the Regulator in Quebec, show a LVRT curve that is different from what PRC-024-2 requires (attachment 2). The LVRT requirement reflects the specific needs to ensure reliability of the Quebec Interconnection, taking into account the conventional and non-conventional generation. The LVRT curve was established in response to FERC Order No. 661-A issued on December 12, 2005, which considered the integration of wind generation. Thus, Hydro-Quebec requests to add this item into this SAR for PRC-024-2.</p>	<p>The SAR gives the latitude to address this issue.</p>
<p>In finalizing the SAR, consider benefits to clarity of including a discussion of the frequency bands associated with other NERC standards, for example PRC-006-3 R3. The PRC-006-3 requirement includes a frequency bandwidth less than 60.7 and greater than 59.3 (Eastern Interconnection), while PRC-024 includes a continuous operation bandwidth greater than 59.5 and less than 60.5 (Eastern Interconnection). Although the bandwidths associated with the two standards may address different underlying concerns, clarifying language in PRC-024, could eliminate confusion across the industry with regards to the differences.</p> <p>The SAR may also want to consider potential impacts on traditional generation (as opposed to solar, wind, battery storage, etc.), if the requirements of PRC-024 are revised to be overly specific.</p>	<p>Recommendation: the difference between the PRC-006 and PRC-024 differ by design. No changes necessary to the SAR</p>
<p>Overall, we support this scope item because we agree that operation outside of the "No Trip" zone should not be interpreted as a must trip zone. However, we do not agree with footnote 2 because it adds confusion to the scope and recommend that it be struck from the SAR. Additionally, we suggest consideration be given to removing the use of quotes and capitalization with regards to the term "May Trip," in order to provide the SDT with the necessary latitude to select the best language to define this region.</p>	<p>SAR modified accordingly</p>

While we generally agree with the scope, the bullet “a” for the project scope should be modified to reflect that the region outside the trip curve should reflect equipment limitations and not simply be a “May Trip” zone. Generators should provide grid support during disturbances until equipment limitations are reached. Bullet “a” should be modified as reflected below.

The proposed scope of this project is as follows:
Update the PRC-024-2 ride-through curves to specify that the area outside the “No Trip” zone is an “Equipment Limitation” “May Trip” zone, so that it is not erroneously interpreted as a “Must Trip” zone and define that region to have generators set to allow ride-through until an equipment limitation is reached (Redlines and strikethroughs cannot be shown in this text box - please to the attachment word file for clarity)

Disposition: the SDT has the discretion to modify the standard in the manner to cover this comment. Making the proposed changes to the SAR would be additionally prescriptive.

We believe that the wording found footnote 1 is adequate and sufficient to indicate that the voltage and frequency protective equipment application is neither required to be installed or activated due to the requirements of this standard. Note the wording of the footnote reads "Each Generator Owner is not required to have frequency or voltage protective relaying (...) installed or activated on its unit.

Recommendation: while these assertions may be relevant, there is no need to modify the SAR based off them.

While Xcel Energy generally supports the scope outlined in the SAR, we do have some concern regarding applicability to our traditional equipment.
Page 5 of the Gaps White paper states: "Similarly, frequency trip settings for generation resources should be set as wide as possible while still ensuring equipment protection and personnel safety to support BPS reliability. This aligns with the intent of PRC- 024-2. One possible solution could be to change the requirement such that relay settings be set based on equipment limitations but no narrower than the “No-Trip” zones."
In regards to this statement, we do not have unit-specific frequency limits or unit-specific V/Hz damage curves in some instances. We have generally set our relays per long-standing, general OEM recommendation or by coordinating with equipment type and typical V/Hz damage curves provided by IEEE, EPRI, CIGRE, etc. Our concern if this is changed in the standard, is use of general OEM recommendations and industry typical equipment damage curves and if this would be sufficient to show compliance/due diligence with setting relays “as wide as possible”. We would like to make sure that none of the recommended changes for inverter-based generation would be detrimental to conventional generators or inconsistent with the burdens placed on conventional generators by the standard.

Recommendation: while these assertions may be relevant, there is no need to modify the SAR based off them.

<p>Instantaneous sampling of frequency by IBRs was a contributing factor in the Blue Cut Fire and we understand that manufacturers of IBRs have already addressed this issue. (See 900 MW Fault Induced Solar Photovoltaic Resource Interruption Disturbance Report (i.e., Canyon 2 Report), Key Findings 1 on page iv). The SDT should limit their work on this item to clarifying that frequency should not be calculated instantaneously to define trip parameters. We recommend changing “and ensure” to “to ensure” and adding “to define the trip parameters” to the end of item b. We believe that the scope of this SAR should steer clear of defining technology specifications. Organizations such as the IEEE are more effective and efficient venues for developing such specifications for how frequency is to be measured because their process would allow the manufacturers and the industry to work through these issues. This is similar to when relay manufacturers began developing microprocessor relays for the Industry. Relay manufacturers worked with appropriate standards making organizations such as the IEEE, which worked with industry and manufacturers to develop products that met the needs of the industry.</p>	<p>Recommendation: make redline changes accordingly.</p>
<p>The Off Nominal Frequency Capability Curve is drawn on a semi-log graph which makes it impossible to show the zero time stamp. The table of values provides this clarification. We agree that inaccurate frequency measurements should not be used in protection trip equations.</p>	<p>Recommendation: the SAR provides the latitude for the SDT to address these comments.</p>
<p>EEL supports clarifications to the Voltage Ride-Through Curve Clarifications for Curve Details 1, 3 and 5; however, encourages NERC to do this in a technology-neutral manner rather than providing IBR specifications.</p>	<p>Recommendation: the SAR provides the latitude for the SDT to address these comments.</p>
<p>The voltage ride-through time duration curve is plotted in per unit voltage, so the specific voltage chosen to be evaluated may be either RMS or crest values.</p>	<p>Recommendation: the SAR provides the latitude for the SDT to address these comments.</p>
<p>Regarding Item d and the reference to “individual” generating units, the objective is to cover or “consider” the largest and smallest impedances in the voltage drop calculations. We recommend striking the “individual” generating unit reference and state, “...the Generator Owner needs to consider the largest and smallest impedances in its voltage drop calculations”. This should meet the reliability object without forcing entities to show voltage drop calculations for each wind turbine or solar inverter for zero defect compliance audits.</p>	<p>SAR modified accordingly</p>
<p>Development of Implementation Guidance is an option of every Standards Drafting project and / or team, the Company believes the reference in the SAR is unnecessary and be removed.</p>	<p>SAR modified accordingly</p>

EEl recommends that item “d” be removed from the SAR scope. It is unclear why the requirements would need to be reinforced or clarified further since the language contained in Requirement R2 is clear that generator voltage protective relay settings are to be set so that generator voltage relays do not trip as a result of defined voltage excursions at the Point of Interconnection. We are unaware of any on-going compliance concerns or confusion on this point and are concerned that this scope item may lead to prescriptive language in an attempt to address specific resource types or site configurations, which will move the standard away from a results-based standard. If during the development process for this standard the SDT determines that new Implementation Guidance is needed, based on their modifications to PRC-024-2; we would support such actions but do not believe this needs to be in the SAR language.

SAR modified accordingly

With respect to part d of the Project Scope portion of the SAR, the following portion appears to be outside the scope of the existing standard, which is protection, not voltage settings:

“ . . . and clarify further that the Generator Owner needs to consider this when developing the voltage settings for individual generating units (this pertains to both synchronous and inverter-based resources). If possible, provide either Implementation Guidance or example calculations within the standard for dispersed power producing (inverter-based) resources.”

SAR modified accordingly

The SDT should clearly state the scope of protective devices or relays. Is the scope protective relays only or is it protective devices in addition to relays?

The MRO NSRF recommends that SDT clarify item e in the SAR to align with the PRC-024 reliability objective and the current NERC Protection System definition. Item e from:

Clarify if the voltage and frequency protective functions within an inverter control system that trip the inverter are subject to the requirements of PRC-024-2.3

to:

Clarify the PRC-024 scope is to identify and set frequency and voltage protective relays or protective devices that respond to electrical quantities and directly trip the generator

Recommendation: the SAR provides the latitude for the SDT to address these comments.

EEl supports the concept that generator voltage and frequency protection within an inverter control system, regardless of where it resides, should do so in conformance with PRC-024. We support the SAR’s position that there is a lack of clarity in the language of the currently enforceable version of PRC-024, noting that the intent is to limit this Reliability Standard to generator frequency and generator voltage protective relays but there is no clear acknowledgement or guidance related to generator trips that could result from a generating plant’s auxiliary equipment protection systems (either directly or via tripping signals). We suggest modifying this SAR scope item to: “Clarify that the PRC-024 reliability objective is to identify and set generator frequency and generator voltage protective relays or other protective devices that respond to electrical quantities and directly trip the generator.”

Recommendation: the SAR provides the latitude for the SDT to address these comments.

<p>Since the standard pertains to the voltage and frequency protective functions which directly trip the plant and are applied to the individual generating unit, we agree that voltage and frequency protection functions applied uniformly within each inverter controller, when acting together to emulate a single protection element for the entire plant, should be included in the scope of the existing PRC-024. While the parenthetical elements found in footnote 1 of the existing standard were addressing the multi-function microprocessor based protective relays and the microprocessor-based excitation control systems with protection elements that replicated the digital protective relays, we believe that it applies to inverter-based protection elements set commonly across a plant for tripping. Further, the notion of what is meant by "tripping" needs to be clarified to be the shutdown action performed by the protection system which requires manual intervention for restarting the plant (reset, reclose, re-sync, etc.) The pause and automatic restart control function performed at many inverter-based generating stations is a control feature rather than a protection system feature. Automatic restarts are not advisable for any protection system operation without manual intervention and investigation.</p>	<p>Recommendation: the SAR provides the latitude for the SDT to address these comments.</p>
<p>The Company supports the SAR in adding a definition of momentary cessation to mitigate confusion within the compliance arena, the Company believes this to be necessary.</p>	<p>The SAR DT thanks you for your support.</p>
<p>While EEI member companies have varied views on this issue, we agree that there are reliability benefits to providing language in PRC-024 that state that momentary cessation (a control function) is an unacceptable response during system disturbances within the "No Trip" zone as defined within PRC-024. While we recognize that this mode of operation can be a useful response for resources connected at a distribution level, those resources are generally excluded from consideration due to the BES definition exclusion rules. We also recommend that the second sentence under this scope item be struck from the SAR since all BES resources should be held to the same standard in a technology neutral manner. EEI sees benefit in defining momentary cessation, within the Glossary of Terms, if the SDT decides to utilize this term within revisions to PRC-024. However, we do not believe that the last sentence in this scope item is necessary for the SAR Scope. Although the sentence includes "may need," it is understood that the SDT has flexibility to determine whether momentary cessation should be defined and whether guidance should be provided.</p>	<p>SAR modified accordingly</p>
<p>The Company does not have a predetermined point of view regarding the need for additional Implementation Guidance. On the other hand, it may very well be necessary. Development of Implementation Guidance is an option of every Standards Drafting project and / or team, the Company believes the reference in the SAR is unnecessary and be removed.</p>	<p>SAR modified accordingly</p>

<p>EEl recommends that this scope item be removed from the SAR Scope because we do not believe that compliance treatment for specific non-compliance violations is an appropriate element of a NERC Reliability Standard. We also believe that it is clear that all BES resources, regardless of type or technology, at a plant site should operate in line with the frequency and voltage requirements as set forth in this Reliability Standard (i.e., do not trip within the “No Trip” zone), unless there are known regulatory or equipment limitations. In those cases, the equipment limitations are to be reported to the Planning Coordinator and Transmission Coordinator per Requirement R3. For this reason, we do not believe that this scope item is needed. The SDT may decide that implementation guidance may be appropriate to help address compliance questions; however, we do not believe that Implementation Guidance should be a SAR Scope item because it is understood that this is an option for all SDTs.</p>	<p>Item g removed</p>
<p>Owners of power conversion equipment used for power generation whose control functionality does not have the capability to be set up to eliminate momentary cessation should be provided the documentation option provided in Requirement R3 of PRC-024-2. This could be clarified as permissible through modification of the existing footnote 5 by "not excluding the limitations that are cause by the setting capability of the control system."</p>	<p>Item g removed</p>
<p>While NV Energy agrees that the region outside of the “No Trip” zone should not be interpreted as a must trip zone, we do not think that the SAR should predetermine what this region should be called and agree that the SDT should be given latitude to determine how best to address this concern. We are also concerned with the heavy emphasis on one type of resource (i.e., IBRs) within the SAR rather than addressing ambiguities affecting all resources and resource owners currently contained within PRC-024-2. While we understand the current concerns relate to IBRs, trying to resolve all misunderstandings by technology type within a Reliability Standard is not consistent with a technology neutral approach. We support the statements made by the Essential Reliability Task Force that recognized “that ERSs are technology neutral and must be provided regardless of the resource mix composition for a given operating area or Balancing Area (BA).” (see ERSTF – Concept Paper on ERS that Characterizes BPS Reliability October 2014, page vi). From this perspective, we believe that PRC-024 should address current concerns and ambiguities broadly without focusing on specific technologies but be inclusive of considerations for IBRs.</p>	<p>The SAR DT has the discretion to modify the SAR and establish a scope of work for the proposed project that accommodates these comments.</p>
<p>The region outside the trip curve should reflect equipment limitations only and not simply be a “May Trip” zone. Generators should provide grid support during disturbances until equipment limitations are reached. We propose that the detailed description clarifies that for inverters not yet installed, momentary cessation should be completely prohibited in the ‘No Trip’ zone. For inverters already installed, the only time momentary cessation can be used in the ‘No Trip’ zone is, if it has been reported as an equipment limitation as per Requirement R3.</p>	<p>The SAR DT has the discretion to modify the SAR and establish a scope of work for the proposed project that accommodates these comments.</p>

<p>1. OK with adding “May Trip” labels to the curves. However, the description states: “This will enhance reliability since the generator owner, operator, developer, and equipment manufacturer will understand that the inverter protective trip settings should be based on equipment capability...” We believe that a lot of legacy generators use settings based on “best industry practices” and not necessarily actual generator capability, and any requirement or even implication that these must be set based on generator capability could result in excessive burden attempting to determine what the actual settings should be and we believe this is outside the scope of this standard.</p>	<p>Recommendation: the SDT has the discretion to modify the standard in the manner to cover this comment. Making the proposed changes to the SAR is not necessary and could potentially be overly prescriptive.</p>
<p>We agree that the deliverables outlined in the Detailed Description section support the identified Project Scope. While inverter based resources appear to be the primary focus for the revisions, we request that the potential for scope creep be closely monitored as it relates to Item 1 in the detailed description. Specifically, the language noting that inverter protective trip settings should be based on equipment capability is cause for concern. It would be overly burdensome if this issue results in traditional generation needing to conduct capability testing or produce studies to demonstrate that their trip settings are based on equipment capability.</p>	<p>Recommendation: the SDT has the discretion to modify the standard in the manner to cover this comment. Making the proposed changes to the SAR is not necessary and could potentially be overly prescriptive.</p>
<p>The NSRF also recommends the last sentence in Item 1 of the Detailed Description be removed in order to avoid scope creep and ensure application of the standard as originally intended.</p>	<p>SAR modified accordingly</p>
<p>While NV Energy agrees that frequency cannot and should not be measured or calculated using instantaneously sampled values, clarifications may be useful to manufacturers who have less familiarity with the methods used by the industry to measure frequency. Additionally, while adding clarification may be useful, we suggest care be given to ensure those clarifications being considered do not extend into areas that might be better suited to guidelines and technical standards (such as produced by the IEEE) rather than what would be appropriate to a Reliability Standard. Moreover, issues related to this concern, as described in the Blue Cut Fire Report, were resolved by IBR manufacturers and the industry as a result of the NERC Alerts and confirmed by the Canyon 2 Report. (see our comments to Question 1, Item b)</p>	<p>Recommendation: the SDT has the discretion to modify the standard in the manner to cover this comment. Making the proposed changes to the SAR is not necessary and could potentially be overly prescriptive.</p>
<p>The Generator Owner and/or manufacturer of the equipment should convert their phase voltage measurements to positive-sequence values. We propose that the term ‘positive-sequence’ be added as follows: “If RMS, clarify that the RMS signal pertains to positive-sequence to the fundamental frequency RMS signal rather than the true RMS signal.</p>	<p>Recommendation: the SDT has the discretion to modify the standard in the manner to cover this comment. Making the proposed changes to the SAR is not necessary and could potentially be overly prescriptive.</p>
<p>WEC Disagrees. Consider the impact of this requirement on electromechanical protective relays as they have no filtering capabilities.</p>	<p>Clarifications Made</p>
<p>It is not clear what is meant by start, stop, and reset under Item 5 on page 5 of SAR. Please clarify what is meant by each position.</p>	<p>Clarifications Made</p>

Technical issue #6 on page 6 of the SAR may also need to be expanded to include other types of voltage and frequency control systems within a wind turbine, specifically “smart crowbar” protective functions which can trip a turbine during transient voltage conditions. Texas RE requests the SAR include these issues.

The SAR as written is not technologically bias or prescriptivek SDT has the latitude to proceed in the best manner.

Please consider rewording the details contained in the SAR to allow for the problems to be addressed but not be read as the “only” way the issue can be addressed by the SDT.

The SAR as written is not technologically bias or prescriptivek SDT has the latitude to proceed in the best manner.

Reliability Standards should be technology neutral. The detailed description should be limited to removing ambiguity from the standard. Technical Rationale documents and/or compliance Implementation Guidance documents could be written if the drafting team determines that further explanation is needed for inverter-based generation.

The SAR as written is technologically bias or prescriptive so that the SDT has the latitude to proceed in the best manner.

Unofficial Nomination Form

Project 2018-04 Modifications to PRC-024-2 Standard Authorization Request Drafting Team

Do not use this form for submitting nominations. Use the [electronic form](#) to submit nominations for Standard Authorization Request drafting team members by **8 p.m. Eastern, Friday, January 18, 2019**. This unofficial version is provided to assist nominees in compiling the information necessary to submit the electronic form.

Additional information is available on the [project page](#). If you have questions, contact Standards Developer, [Mat Bunch](#) (via email) or at (404) 446-9785.

By submitting a nomination form, you are indicating your willingness and agreement to actively participate in face-to-face meetings and conference calls.

Previous drafting or review team experience is beneficial, but not required. A description of the desired qualifications, expected commitment, and other pertinent information is included below.

Project 2018-04 Modifications to PRC-024-2 – Background

On November 27, 2018, the NERC Operating Committee (OC) and Planning Committee (PC) submitted a Standard Authorization Request (SAR) prepared by the Inverter-Based Resource Performance Task Force (IRPTF), which reports to the OC and PC.

In 2017, the OC and PC convened the IRPTF shortly after it became clear that inverter-based generation was dropping off-line during normally cleared Bulk Power System (BPS) line faults. The NERC IRPTF supported NERC and WECC staff in the analysis of the [Blue Cut Fire](#) and [Canyon 2 Fire](#) disturbances in southern California. From the key findings and recommendations in the reports on the analysis, the IRPTF as a stakeholder group of industry experts developed recommended performance characteristics from inverter-based resources connected to the BPS.

Based off the disturbance analyses and development of the [PRC-024-2 Gaps Whitepaper](#), the IRPTF identified potential modifications to PRC-024-2 to help ensure that inverter-based generator owners, operators, developers, and equipment manufacturers understand the intent of the standard in order for their plants respond to grid disturbances in a manner that contributes to the reliable operation of the BPS.

This SAR proposes to revise PRC-024-2 to address the identified issues in the standard.

NERC is seeking individuals from the United States and Canada who possess knowledge and expertise in one or more of the following areas:

- Protection system settings and performance;
- Transmission Planning stability experience in synchronous and inverter-based resource performance during voltage and frequency excursions;
- Inverter-based resources experience, including performance characteristics, inverter manufacturers, control systems with protective functions, and experience in dynamic simulations for inverter-based generation.

NERC is also seeking individuals who have facilitation skills or legal/technical writing backgrounds as well as those who have experience with developing standards inside or outside the NERC development process (e.g., IEEE, NAESB, ANSI, etc.). Such experience should be highlighted in the information submitted, if applicable.

The time commitment for these projects is expected to be up to two face-to-face meetings per quarter (on average two full working days each meeting) with conference calls scheduled as needed to meet the agreed-upon timeline the review or drafting team sets forth. Team members may also have side projects, either individually or by subgroup, to present to the larger team for discussion and review. Last, an important component of the review and drafting team effort is outreach. Members of the team will be expected to conduct industry outreach during the development process to support a successful project outcome.

Name:		
Organization:		
Address:		
Telephone:		
E-mail:		
Please briefly describe your experience and qualifications to serve on the requested Standard Drafting Team (Bio):		
<p>If you are currently a member of any NERC drafting team, please list each team here:</p> <input type="checkbox"/> Not currently on any active SAR or standard drafting team. <input type="checkbox"/> Currently a member of the following SAR or standard drafting team(s):		
<p>If you previously worked on any NERC drafting team please identify the team(s):</p> <input type="checkbox"/> No prior NERC SAR or standard drafting team. <input type="checkbox"/> Prior experience on the following team(s):		
<p>Select each NERC Region in which you have experience relevant to the Project for which you are volunteering:</p>		
<input type="checkbox"/> Texas RE <input type="checkbox"/> FRCC <input type="checkbox"/> MRO	<input type="checkbox"/> NPCC <input type="checkbox"/> RF <input type="checkbox"/> SERC	<input type="checkbox"/> WECC <input type="checkbox"/> NA – Not Applicable

Select each Industry Segment that you represent:	
<input type="checkbox"/>	1 — Transmission Owners
<input type="checkbox"/>	2 — RTOs, ISOs
<input type="checkbox"/>	3 — Load-serving Entities
<input type="checkbox"/>	4 — Transmission-dependent Utilities
<input type="checkbox"/>	5 — Electric Generators
<input type="checkbox"/>	6 — Electricity Brokers, Aggregators, and Marketers
<input type="checkbox"/>	7 — Large Electricity End Users
<input type="checkbox"/>	8 — Small Electricity End Users
<input type="checkbox"/>	9 — Federal, State, and Provincial Regulatory or other Government Entities
<input type="checkbox"/>	10 — Regional Reliability Organizations and Regional Entities
<input type="checkbox"/>	NA — Not Applicable
Select each Function ¹ in which you have current or prior expertise:	
<input type="checkbox"/> Balancing Authority	<input type="checkbox"/> Transmission Operator
<input type="checkbox"/> Compliance Enforcement Authority	<input type="checkbox"/> Transmission Owner
<input type="checkbox"/> Distribution Provider	<input type="checkbox"/> Transmission Planner
<input type="checkbox"/> Generator Operator	<input type="checkbox"/> Transmission Service Provider
<input type="checkbox"/> Generator Owner	<input type="checkbox"/> Purchasing-selling Entity
<input type="checkbox"/> Interchange Authority	<input type="checkbox"/> Reliability Coordinator
<input type="checkbox"/> Load-serving Entity	<input type="checkbox"/> Reliability Assurer
<input type="checkbox"/> Market Operator	<input type="checkbox"/> Resource Planner
<input type="checkbox"/> Planning Coordinator	

¹ These functions are defined in the NERC [Functional Model](#), which is available on the NERC web site.

Provide the names and contact information for two references who could attest to your technical qualifications and your ability to work well in a group:

Name:		Telephone:	
Organization:		E-mail:	
Name:		Telephone:	
Organization:		E-mail:	

Provide the name and contact information of your immediate supervisor or a member of your management who can confirm your organization’s willingness to support your active participation.

Name:		Telephone:	
Title:		Email:	

Standards Announcement

Project 2018-04 Modifications to PRC-024-2

Nomination Period Open through January 18, 2019

[Now Available](#)

Nominations are being sought for Standard Authorization Request drafting team members through **8 p.m. Eastern, Friday, January 18, 2019.**

Use the [electronic form](#) to submit a nomination. If you experience issues, contact [Wendy Muller](#). An unofficial Word version of the nomination form is posted on the [Drafting Team Vacancies](#) page and the [project page](#).

By submitting a nomination form, you are indicating your willingness and agreement to actively participate in face-to-face meetings and conference calls.

NERC is seeking individuals from the United States and Canada who possess knowledge and expertise in one or more of the following areas:

- Protection system settings and performance;
- Transmission Planning stability experience in synchronous and inverter-based resource performance during voltage and frequency excursions;
- Inverter-based resources experience, including performance characteristics, inverter manufacturers, control systems with protective functions, and experience in dynamic simulations for inverter-based generation.

NERC is also seeking individuals who have facilitation skills or legal/technical writing backgrounds as well as those who have experience with developing standards inside or outside the NERC development process (e.g., IEEE, NAESB, ANSI, etc.). Such experience should be highlighted in the information submitted, if applicable.

Previous drafting or periodic review team experience is beneficial, but not required. See the [project page](#) and unofficial nomination form for additional information.

Next Steps

The Standards Committee is expected to appoint members to the team in Q1 2019. Nominees will be notified shortly after they have been selected.

For information on the Standards Development Process, refer to the [Standard Processes Manual](#).

For more information or assistance, contact Standards Developer, [Mat Bunch](#) (via email) or at (404) 446-9785.

North American Electric Reliability Corporation
3353 Peachtree Rd, NE
Suite 600, North Tower
Atlanta, GA 30326
404-446-2560 | www.nerc.com

Standard Authorization Request (SAR)

Complete and please email this form, with attachment(s) to: sarcomm@nerc.net

The North American Electric Reliability Corporation (NERC) welcomes suggestions to improve the reliability of the bulk power system through improved Reliability Standards.

Requested information			
SAR Title:	PRC-024-2 Generator Frequency and Voltage Protective Relay Settings		
Date Submitted:	11/27/2018		
SAR Requester			
Name:	Lloyd Linke (NERC OC Chair) Brian Evans-Mongeon (NERC PC Chair)		
Organization:	Lloyd – Western Area Power Administration (NERC Operating Committee) Brian – Utility Services, Inc. (NERC Planning Committee)		
Telephone:	Lloyd – 605-882-7500 Brian – 802-241-1400	Email:	lloyd@wapa.gov brian.evans-mongeon@utilitysvcs.com
SAR Type (Check as many as apply)			
<input type="checkbox"/>	New Standard	<input type="checkbox"/>	Imminent Action/ Confidential Issue (SPM Section 10)
<input checked="" type="checkbox"/>	Revision to Existing Standard	<input type="checkbox"/>	Variance development or revision
<input type="checkbox"/>	Add, Modify or Retire a Glossary Term	<input type="checkbox"/>	Other (Please specify)
<input type="checkbox"/>	Withdraw/retire an Existing Standard		
Justification for this proposed standard development project (Check all that apply to help NERC prioritize development)			
<input type="checkbox"/>	Regulatory Initiation	<input checked="" type="checkbox"/>	NERC Standing Committee Identified
<input checked="" type="checkbox"/>	Emerging Risk (Reliability Issues Steering Committee) Identified	<input type="checkbox"/>	Enhanced Periodic Review Initiated
<input type="checkbox"/>	Reliability Standard Development Plan	<input checked="" type="checkbox"/>	Industry Stakeholder Identified
Industry Need (What Bulk Electric System (BES) reliability benefit does the proposed project provide?):			
<p>The NERC Integration of Variable Generation Task Force (IVGTF) was convened many years ago and developed a technical report that highlighted a number of topics and issues related to variable generation that would need to be addressed. The NERC IVGTF specifically highlighted that potential changes would need to be made to NERC Standards, including PRC-024-2, to ensure consistency and clarity for inverter-based resources.</p> <p>In 2017, NERC convened the Inverter-Based Resource Performance Task Force (IRPTF) shortly after it became clear that inverter-based generation was dropping off-line during normally cleared BPS line faults. The NERC IRPTF supported NERC and WECC Staff in the analysis of the Blue Cut Fire and Canyon 2 Fire disturbances in southern California.¹ From the key findings and recommendations of those reports,</p>			

¹ An ad-hoc task force supported the development of the Blue Cut Fire disturbance report, which subsequently developed into the NERC IRPTF.

Requested information

the NERC IRPTF as a stakeholder group of industry experts developed recommended performance characteristics from inverter-based resources connected to the BPS. The recommended performance is documented in the NERC Reliability Guideline: BPS-Connected Inverter-Based Resource Performance, published September 2018. During the disturbance analyses and development of the Reliability Guideline, the NERC IRPTF identified a number of technical issues with PRC-024-2 that require clarification and correction to ensure inverter-based generator owners, operators, developers, and equipment manufacturers clearly understand the intent of the standard so their plants respond to grid disturbances in a manner that contributes to the reliable operation of the bulk power system.

These issues include:

- a. Modifying the region outside the “No Trip” zone of the ride through curves so that registered entities do not interpret this area as a must trip zone.
- b. Clarifying the “Off Nominal Frequency Capability Curve” and the “Curve Data Point” tables on pages 8 and 9 of PRC-024-2 to reconcile the apparent 0.1-sec time delay in the frequency capability curve with the curve data point table that allows instantaneous (i.e., no deliberate time delay) operation. Calculation of frequency over a window or time period should also be clarified.
- c. Clarifying the language in point #5 of the Curve Details found in the Voltage Ride-Through Curve Clarifications (page 11 of PRC-024-2) to eliminate confusion as to whether the curves pertain to RMS (Root Mean Square) or crest values. If RMS, clarify that the RMS signal pertains to the fundamental frequency RMS signal rather than the true RMS signal.
- d. Removing inconsistency regarding per unit voltage and nominal operating voltage by correcting point #1 of the Curve Details found in the Voltage Ride-Through Curve Clarifications (page 11 of PRC-024-2).
- e. Clarifying the implied functionality of cumulative time (point #3 of the Curve Details in the Voltage Ride-Through Curve Clarifications – Page 11 of PRC-024-2) by explicitly specifying the conditions for when cumulative values for low and high voltage curves start, stop, and reset.
- f. Clarifying whether the voltage and frequency protection functions within the inverter that can trip the inverter are subject to the standard requirements, and clarify any confusion related to footnote 1.
- g. Clarifying the definition and whether the use of momentary cessation for inverter-based resources within the “No Trip” zone of PRC-024-2 is acceptable. If the use of momentary cessation within the “No Trip” zone of PRC-024-2 should be disallowed, then its use should be reported as an equipment limitation per Requirement R3 if used. The Standard Drafting Team (SDT) should further consider the acceptability of using of momentary cessation for very low voltages within the “No Trip” zone of PRC-024-2.

This SAR proposes to address these technical issues.

Requested information
Purpose or Goal (How does this proposed project provide the reliability-related benefit described above?):
This SAR proposes to revise PRC-024-2 to address ambiguities, inconsistencies, and technical errors within the existing standard. The goal is to add clarity, eliminate inconsistency and address ambiguity in the existing requirements.
Project Scope (Define the parameters of the proposed project):
<p>The proposed scope of this project is as follows:</p> <ul style="list-style-type: none"> a. Update the PRC-024 ride-through curves to clarify that the area outside the “No Trip” zone is not erroneously interpreted as requiring resources to trip. b. Clarify inconsistencies between the Curve Data Point tables and the Off Nominal Frequency Capability Curves (pages 8 & 9) to ensure that instantaneously calculated frequency is not permissible to define the trip parameters. c. Clarify the language in points #1, #3, and #5 of the Curve Details section of the “Voltage Ride-Through Curve Clarifications” on page 11. d. Consider whether the SDT should address manners in which to reinforce that the requirements pertain to the Point of Interconnection. e. Clarify if the voltage and frequency protective functions within an inverter control system that trip the inverter are subject to the requirements of PRC-024. f. Clarify that plant auxiliary equipment protection systems are not subject to the requirements of PRC-024. g. Clarify whether the use of momentary cessation (a control function) within the “No Trip” zone of PRC-024 does not comply with the standard. The SDT should consider the use of momentary cessation for very low voltages within the “No Trip” zone of PRC-024. h. The SDT should consider whether Interconnection-specific modification(s) or Regional Variance(s) are necessary for the voltage ride-through time duration curve(s) in Attachment 2. <p>Other topics not addressed here will be considered in future activities of the NERC IRPTF as well as the IEEE p2800 project.</p>
Detailed Description (Describe the proposed deliverable(s) with sufficient detail for a drafting team to execute the project. If you propose a new or substantially revised Reliability Standard or definition, provide: (1) a technical justification ² which includes a discussion of the reliability-related benefits of developing a new or revised Reliability Standard or definition, and (2) a technical foundation document (e.g., research paper) to guide development of the Standard or definition):
The Standards Drafting Team should address the following technical issues within PRC-024-2:

² The NERC Rules of Procedure require a technical justification for new or substantially revised Reliability Standards. Please attach pertinent information to this form before submittal to NERC.

Requested information

1. Update the PRC-024 ride-through curves to clarify that the area outside the “No Trip” zone is not erroneously interpreted as requiring resources to trip. Many newly interconnecting resources (including inverter-based resources) on the BPS are setting voltage and protective functions based solely on these curves, since the area outside the no trip region is incorrectly interpreted as a must trip zone. This practice does not consider the actual capability of the resource to ride through transmission line faults that create conditions outside of the “No Trip” zone. Clarification will help to ensure correct interpretation industry-wide.
2. The “Off Nominal Frequency Capability Curve” (page 8 of PRC-024-2) is a logarithmic graph that starts at time $t=0.1$ seconds. However, the tables in the “Curve Data Point” section (pages 8 and 9 of PRC-024-2) allow for “instantaneous trip”. Frequency cannot and should not be measured or calculated using an instantaneously sampled value. Frequency calculation methods use various types of time windows and filtering methods in order to accurately calculate grid frequency. Typically, these methods use a window on the order of 100 milliseconds (6 cycles). Thus, a delay of 100 milliseconds would occur even if the protective relay algorithm has no intentional time delay. This delay should be reflected in the standard. Also, the IRPTF identified that erroneous tripping due to frequency calculation errors was a significant factor in the Blue Cut Fire disturbance. Eliminating instantaneous tripping for frequency disturbances reduces the probability of incorrect tripping due to spurious noise in the measured voltage, for example during the period of fault clearing.
3. Point #5 in the Curve Details section of the “Voltage Ride-Through Curve Clarifications” (page 11 of PRC-024-2) states, “voltages in the curve assume minimum fundamental frequency phase to ground or phase to phase voltage for the low duration curve and the greater of maximum RMS (Root Mean Square) or crest phase to phase voltage for the high voltage duration curve.” There are a number of ways this can be interpreted, and issues that need to be addressed.
4. To minimize the probability of incorrect tripping (as noted in point 2 above), any voltage compared with the PRC-024-2 voltage ride through curves should be a well-filtered, fundamental frequency component of the voltage waveform. This will filter out spurious voltage spikes caused by switching action on the BPS. Voltage protective relays should not operate at the voltage levels specified in the voltage ride-through curve using instantaneously sampled values. The clarification should focus on using the RMS value of the voltage, and that the voltage signal should be adequately filtered to obtain this fundamental component.
5. The overvoltage component of the clarification states, “the greater of maximum RMS or crest phase to phase voltage”. The crest value is greater than the RMS value of a periodic waveform, so there is ambiguity regarding which value to apply. Without clarification, inverter-based resources may trip based on different criteria. Failure to address this may lead to reliability issues, as identified in the Canyon 2 Fire disturbance analysis report.
6. Only phase to phase voltage is used for the high voltage component of the PRC-024-2 curve. However, inverter-based resource transient overvoltage protection may be based on phase to

Requested information

ground voltage as well. Use of phase to ground voltage for overvoltage protection needs to be considered.

7. Point #1 of the Curve Details section of the “Voltage Ride-Through Curve Clarifications” on page 11 of PRC-024-2 states, “the per unit voltage base for these curves is the nominal operating voltage specified by the Transmission Planner in the analysis of the reliability of the Interconnected Transmission Systems at the point of interconnection to the Bulk Electric System (BES).” Firstly, the Transmission Planner does not specify nominal operating voltage. Regardless, the per unit base for the curves should be based on the nominal voltage level that the generator is connected to at its Point of Interconnection. This is a static value and can be provided by the Transmission Planner.
8. Point #3 of the Curve Details section of the “Voltage Ride-Through Curve Clarifications” on page 11 of PRC-024-2 states, “The envelope within the curves represents the cumulative voltage duration at the point of interconnection with the BES.” The ride-through curves end at four seconds, and the curves imply a requirement for cumulative time duration for the “No Trip” zone. Protective relays and inverter protective functions within their control systems must be set to accommodate the cumulative nature of ride through curves. Under the current version of PRC-024-2, it is not explicitly clear at what point the cumulative values for the low and high voltage curves start, stop, and reset for multiple ride-through events. There are multiple ways to implement this cumulative effect, which result in different performance, for example during multiple, successive low voltage events. The correct methods for implementing the cumulative time duration should be clarified in PRC-024-2.³
9. The IRPTF identified that it is ambiguous and unclear as to whether the requirements of PRC-024-2 apply to the individual inverters. Footnote 1 does state that “protective functions within control systems that directly trip or provide tripping signals to the generator based on frequency or voltage inputs” are considered as part of the standard. Yet, the group acknowledged that the vagueness of the footnote as well as the synchronous generator-centric language in the requirements makes this confusing. There may exist multiple types of voltage and frequency protection, including relaying or individual inverter protective functions within their control systems that need to be considered in PRC-024-2. This should be clarified and strengthened throughout the standard.
10. Momentary cessation is a form of operation that some inverters have historically used during “ride-through” operation where voltage is outside the continuous operating range of the inverter. Momentary cessation is when zero current is injected into the grid by the inverter. This occurs because the power electronic firing commands are blocked so that the inverter does not produce current. Thus active and reactive current (and subsequently power) go to zero at the inverter terminals. The NERC IRPTF performed stability studies, particularly in the Western

³ Example: One implementation considers one cumulative window timer for both low voltage and high voltage curves, and it starts when the voltage goes outside the continuous operating bounds. Another implementation considers separate cumulative timers and the HV timer starts when the voltage is greater than this curve and the LV timer starts when the voltage is less than that curve.

Requested information
<p>Interconnection, and demonstrated that the propagation and widespread use of momentary cessation, particularly at voltages within the PRC-024-2 voltage ride-through curve, could cause potential situations of instability. Both NERC Alerts following the Blue Cut Fire and Canyon 2 Fire gathered data related to the use of momentary cessation, and the latter NERC Alert explicitly recommended mitigating the use of momentary cessation to the best extent possible for existing and future resources. Clarifying PRC-024-2 relative to the use of momentary cessation within the “No Trip” zone of PRC-024-2 aligns with all these efforts. Momentary cessation within the “No Trip” zone of PRC-024-2 could be reported as an equipment limitation per Requirement R3.</p>
<p>Cost Impact Assessment, if known (Provide a paragraph describing the potential cost impacts associated with the proposed project):</p>
<p>This SAR proposes to clarify some issues and correct others. The cost impact is unknown, but in many cases is expected to be minimal (i.e., will only require changes to existing inverter control software and setting).</p>
<p>Please describe any unique characteristics of the BES facilities that may be impacted by this proposed standard development project (<i>e.g.</i> Dispersed Generation Resources):</p>
<p>Inverter-based resources including asynchronous ties may be impacted by this proposed standard development as Generator Owners, Transmission Owners and Original Equipment Manufacturers may need to change the control programming to enhance capabilities. Other generation resources may be impacted if the clarifications cause them to correct relay settings.</p>
<p>To assist the NERC Standards Committee in appointing a drafting team with the appropriate members, please indicate to which Functional Entities the proposed standard(s) should apply (<i>e.g.</i> Transmission Operator, Reliability Coordinator, etc. See the most recent version of the NERC Functional Model for definitions):</p>
<p>Generator Owners</p>
<p>Do you know of any consensus building activities⁴ in connection with this SAR? If so, please provide any recommendations or findings resulting from the consensus building activity.</p>
<p>Many of these proposals were developed by the NERC IRPTF, are outlined in the NERC Reliability Guideline: BPS-Connected Inverter-Based Resource Performance, and also captured in a white paper on potential standards gaps related to PRC-024-2. There were also similar proposals developed by the NERC IVGTF in 2015.</p>
<p>Are there any related standards or SARs that should be assessed for impact as a result of this proposed project? If so which standard(s) or project number(s)?</p>
<p>Are there alternatives (e.g. guidelines, white paper, alerts, etc.) that have been considered or could meet the objectives? If so, please list the alternatives.</p>
<p>The following materials have been developed by the NERC IRPTF, NERC Staff, and WECC Staff as part of the event analyses of inverter-based resources during BPS disturbances. However, these activities do not address the inconsistencies and technical issues of PRC-024-2 that have been highlighted in all these activities.</p>

⁴ Consensus building activities are occasionally conducted by NERC and/or project review teams. They typically are conducted to obtain industry inputs prior to proposing any standard development project to revise, or develop a standard or definition.

Requested information

- Reliability Guideline: BPS-Connected Inverter-Based Resource Performance: https://www.nerc.com/comm/OC_Reliability_Guidelines_DL/Inverter-Based_Resource_Performance_Guideline.pdf.
- Blue Cut Fire Disturbance Report: <http://www.nerc.com/pa/rrm/ea/Pages/1200-MW-Fault-Induced-Solar-Photovoltaic-Resource-Interruption-Disturbance-Report.aspx>.
- Canyon 2 Fire Disturbance Report: <https://www.nerc.com/pa/rrm/ea/October%209%202017%20Canyon%20%20Fire%20Disturbance%20Report/900%20MW%20Solar%20Photovoltaic%20Resource%20Interruption%20Disturbance%20Report.pdf>.
- NERC Alert I: Loss of Solar Resources during Transmission Disturbances due to Inverter Settings: <https://www.nerc.com/pa/rrm/bpsa/Pages/Alerts.aspx>.
- NERC Alert II: Loss of Solar Resources during Transmission Disturbances due to Inverter Settings: <https://www.nerc.com/pa/rrm/bpsa/Pages/Alerts.aspx>.
- "NERC IVGTF Summary and Recommendation Report", published in June 2015. Relevant to PRC-024-02 are task 1-3 and 1-7: https://www.nerc.com/comm/PC/Integration%20of%20Variable%20Generation%20Task%20Force%201/IVGTF%20Summary%20and%20Recommendation%20Report_Final.pdf.

Reliability Principles

Does this proposed standard development project support at least one of the following Reliability Principles ([Reliability Interface Principles](#))? Please check all those that apply.

<input checked="" type="checkbox"/>	1. Interconnected bulk power systems shall be planned and operated in a coordinated manner to perform reliably under normal and abnormal conditions as defined in the NERC Standards.
<input checked="" type="checkbox"/>	2. The frequency and voltage of interconnected bulk power systems shall be controlled within defined limits through the balancing of real and reactive power supply and demand.
<input type="checkbox"/>	3. Information necessary for the planning and operation of interconnected bulk power systems shall be made available to those entities responsible for planning and operating the systems reliably.
<input type="checkbox"/>	4. Plans for emergency operation and system restoration of interconnected bulk power systems shall be developed, coordinated, maintained and implemented.
<input type="checkbox"/>	5. Facilities for communication, monitoring and control shall be provided, used and maintained for the reliability of interconnected bulk power systems.
<input type="checkbox"/>	6. Personnel responsible for planning and operating interconnected bulk power systems shall be trained, qualified, and have the responsibility and authority to implement actions.
<input type="checkbox"/>	7. The security of the interconnected bulk power systems shall be assessed, monitored and maintained on a wide area basis.
<input type="checkbox"/>	8. Bulk power systems shall be protected from malicious physical or cyber attacks.

Market Interface Principles	
Does the proposed standard development project comply with all of the following Market Interface Principles ?	Enter (yes/no)
1. A reliability standard shall not give any market participant an unfair competitive advantage.	Yes
2. A reliability standard shall neither mandate nor prohibit any specific market structure.	Yes
3. A reliability standard shall not preclude market solutions to achieving compliance with that standard.	Yes
4. A reliability standard shall not require the public disclosure of commercially sensitive information. All market participants shall have equal opportunity to access commercially non-sensitive information that is required for compliance with reliability standards.	Yes

Identified Existing or Potential Regional or Interconnection Variances	
Region(s)/ Interconnection	Explanation
None	None

For Use by NERC Only

SAR Status Tracking (Check off as appropriate)	
<input type="checkbox"/> Draft SAR reviewed by NERC Staff	<input type="checkbox"/> Final SAR endorsed by the SC
<input type="checkbox"/> Draft SAR presented to SC for acceptance	<input type="checkbox"/> SAR assigned a Standards Project by NERC
<input type="checkbox"/> DRAFT SAR approved for posting by the SC	<input type="checkbox"/> SAR denied or proposed as <u>Guidance</u> document

Version History

Version	Date	Owner	Change Tracking
1	June 3, 2013		Revised
1	August 29, 2014	Standards Information Staff	Updated template
2	January 18, 2017	Standards Information Staff	Revised
2	June 28, 2017	Standards Information Staff	Updated template

Standard Authorization Request (SAR)

Complete and please email this form, with attachment(s) to: sarcomm@nerc.net

The North American Electric Reliability Corporation (NERC) welcomes suggestions to improve the reliability of the bulk power system through improved Reliability Standards.

Requested information			
SAR Title:	PRC-024-2 Generator Frequency and Voltage Protective Relay Settings		
Date Submitted:	11/27/2018		
SAR Requester			
Name:	Lloyd Linke (NERC OC Chair) Brian Evans-Mongeon (NERC PC Chair)		
Organization:	Lloyd – Western Area Power Administration (NERC Operating Committee) Brian – Utility Services, Inc. (NERC Planning Committee)		
Telephone:	Lloyd – 605-882-7500 Brian – 802-241-1400	Email:	lloyd@wapa.gov brian.evans-mongeon@utilitysvcs.com
SAR Type (Check as many as apply)			
<input type="checkbox"/>	New Standard	<input type="checkbox"/>	Imminent Action/ Confidential Issue (SPM Section 10)
<input checked="" type="checkbox"/>	Revision to Existing Standard	<input type="checkbox"/>	Variance development or revision
<input type="checkbox"/>	Add, Modify or Retire a Glossary Term	<input type="checkbox"/>	Other (Please specify)
<input type="checkbox"/>	Withdraw/retire an Existing Standard		
Justification for this proposed standard development project (Check all that apply to help NERC prioritize development)			
<input type="checkbox"/>	Regulatory Initiation	<input checked="" type="checkbox"/>	NERC Standing Committee Identified
<input checked="" type="checkbox"/>	Emerging Risk (Reliability Issues Steering Committee) Identified	<input type="checkbox"/>	Enhanced Periodic Review Initiated
<input type="checkbox"/>	Reliability Standard Development Plan	<input checked="" type="checkbox"/>	Industry Stakeholder Identified
Industry Need (What Bulk Electric System (BES) reliability benefit does the proposed project provide?):			
<p>The NERC Integration of Variable Generation Task Force (IVGTF) was convened many years ago and developed a technical report that highlighted a number of topics and issues related to variable generation that would need to be addressed. The NERC IVGTF specifically highlighted that potential changes would need to be made to NERC Standards, including PRC-024-2, to ensure consistency and clarity for inverter-based resources.</p> <p>In 2017, NERC convened the Inverter-Based Resource Performance Task Force (IRPTF) shortly after it became clear that inverter-based generation was dropping off-line during normally cleared BPS line faults. The NERC IRPTF supported NERC and WECC Staff in the analysis of the Blue Cut Fire and Canyon 2 Fire disturbances in southern California.¹ From the key findings and recommendations of those reports,</p>			

¹ An ad-hoc task force supported the development of the Blue Cut Fire disturbance report, which subsequently developed into the NERC IRPTF.

Requested information

the NERC IRPTF as a stakeholder group of industry experts developed recommended performance characteristics from inverter-based resources connected to the BPS. The recommended performance is documented in the NERC Reliability Guideline: BPS-Connected Inverter-Based Resource Performance, published September 2018. During the disturbance analyses and development of the Reliability Guideline, the NERC IRPTF identified a number of technical issues with PRC-024-2 that require clarification and correction to ensure inverter-based generator owners, operators, developers, and equipment manufacturers clearly understand the intent of the standard so their plants respond to grid disturbances in a manner that contributes to the reliable operation of the bulk power system.

These issues include:

- a. Modifying the region outside the “No Trip” zone of the ride through curves so that registered entities do not interpret this area as a must trip zone.
- b. Clarifying the “Off Nominal Frequency Capability Curve” and the “Curve Data Point” tables on pages 8 and 9 of PRC-024-2 to reconcile the apparent 0.1 sec time delay in the frequency capability curve with the curve data point table that allows instantaneous (i.e., no deliberate time delay) operation. Calculation of frequency over a window or time period should also be clarified.
- c. Clarifying the language in point #5 of the Curve Details found in the Voltage Ride-Through Curve Clarifications (page 11 of PRC-024-2) to eliminate confusion as to whether the curves pertain to RMS (Root Mean Square) or crest values. If RMS, clarify that the RMS signal pertains to the fundamental frequency RMS signal rather than the true RMS signal.
- d. Removing inconsistency regarding per unit voltage and nominal operating voltage by correcting point #1 of the Curve Details found in the Voltage Ride-Through Curve Clarifications (page 11 of PRC-024-2).
- e. Clarifying the implied functionality of cumulative time (point #3 of the Curve Details in the Voltage Ride-Through Curve Clarifications – Page 11 of PRC-024-2) by explicitly specifying the conditions for when cumulative values for low and high voltage curves start, stop, and reset.
- f. Clarifying whether the voltage and frequency protection functions within the inverter that can trip the inverter are subject to the standard requirements, and clarify any confusion related to footnote 1.
- g. Clarifying the definition and whether the use of momentary cessation for inverter-based resources within the “No Trip” zone of PRC-024-2 is acceptable. If the use of momentary cessation within the “No Trip” zone of PRC-024-2 should be disallowed, then its use should be reported as an equipment limitation per Requirement R3 if used. The Standard Drafting Team (SDT) should further consider the acceptability of using of momentary cessation for very low voltages within the “No Trip” zone of PRC-024-2.

Requested information

~~h. Clarifying how situations of partial tripping (i.e., tripping of some but not all inverters in a dispersed power producing resource) or partial momentary cessation would be treated with respect to PRC-024-2 compliance.~~

This SAR proposes to address these technical issues.

Purpose or Goal (How does this proposed project provide the reliability-related benefit described above?):

This SAR proposes to revise PRC-024-2 to address ambiguities, inconsistencies, and technical errors within the existing standard. The goal is to add clarity, eliminate inconsistency and address ambiguity in the existing requirements.

Project Scope (Define the parameters of the proposed project):

The proposed scope of this project is as follows:

- a. Update the PRC-024-2 ride-through curves to specify/clarify that the area outside the “No Trip” zone ~~is a “May Trip” zone,² so that it~~ is not erroneously interpreted as a ~~“Must Trip” zone requiring resources to trip.~~
 - b. Clarify inconsistencies between the Curve Data Point tables and the Off Nominal Frequency Capability Curves (pages 8 & 9); and to ensure that instantaneously calculated frequency is not permissible to define the trip parameters.
 - c. Clarify the language in points #1, #3, and #5 of the Curve Details section of the “Voltage Ride-Through Curve Clarifications” on page 11.
 - d. ~~Reinforce~~ Consider whether the SDT should address manners in which to reinforce that the requirements pertain to the Point of Interconnection, ~~and clarify further that the Generator Owner needs to consider this when developing the voltage settings for individual generating units (this pertains to both synchronous and inverter-based resources). If possible, provide either Implementation Guidance or example calculations within the standard for dispersed power producing (inverter-based) resources.~~
 - e. Clarify if the voltage and frequency protective functions within an inverter control system that trip the inverter are subject to the requirements of PRC-024-2.³
 - f. Clarify that plant auxiliary equipment protection systems are not subject to the requirements of PRC-024.
- ~~e.g. Specify/Clarify that whether~~ the use of momentary cessation (a control function) within the “No Trip” zone of PRC-024-2 does not comply with the standard. The SDT should consider the use of momentary cessation for very low voltages within the “No Trip” zone of PRC-024-2. ~~The SDT~~

²Another option is to refer to this as “Prefer No Trip”. The SDT can determine the best language; however, it should be clear that resources do not necessarily have to trip outside the curve yet are permitted to in order to protect facilities and personnel.

³This clarification could also further strengthen that station service voltage settings or tripping are not considered in scope of the standard. The standard pertains to the voltage and frequency related tripping directly applied to the individual generating unit(s).

Requested information

~~may need to define momentary cessation, and provide guidance on the performance of inverter control systems during a voltage disturbance within the “No Trip” zone of PRC-024-2.~~

~~f. Clarify how situations of partial tripping or partial momentary cessation would be treated with respect to PRC-024-2 compliance.~~

h. The SDT should consider whether Interconnection-specific modification(s) or Regional Variance(s) are necessary for the voltage ride-through time duration curve(s) in Attachment 2.

Other topics not addressed here will be considered in future activities of the NERC IRPTF as well as the IEEE p2800 project.

Detailed Description (Describe the proposed deliverable(s) with sufficient detail for a drafting team to execute the project. If you propose a new or substantially revised Reliability Standard or definition, provide: (1) a technical justification⁴ which includes a discussion of the reliability-related benefits of developing a new or revised Reliability Standard or definition, and (2) a technical foundation document (e.g., research paper) to guide development of the Standard or definition):

The Standards Drafting Team should address the following technical issues within PRC-024-2:

1. Update the PRC-024 ride-through curves to clarify that the area outside the “No Trip” zone is not erroneously interpreted as requiring resources to trip. The region outside the “No Trip” zone of the PRC-024-2 ride-through curves should be clearly marked as a “May Trip” zone so this region is not incorrectly interpreted as a “Must Trip” zone. Many newly interconnecting resources (including inverter-based resources) on the BPS are setting voltage and protective functions based solely on these curves, since the area outside the no trip region is incorrectly interpreted as a must trip zone. This practice does not consider the actual capability of the resource to ride through transmission line faults that create conditions outside of the “No Trip” zone. Clarification will help to ensure correct interpretation industry-wide. ~~This will enhance reliability since the generator owner, operator, developer, and equipment manufacturer will understand that the inverter protective trip settings should be based on equipment capability if it exceeds the curves in the standard, minimizing undesired tripping of inverter-based generation that may not be necessary.~~
2. The “Off Nominal Frequency Capability Curve” (page 8 of PRC-024-2) is a logarithmic graph that starts at time t=0.1 seconds. However, the tables in the “Curve Data Point” section (pages 8 and 9 of PRC-024-2) allow for “instantaneous trip”. Frequency cannot and should not be measured or calculated using an instantaneously sampled value. Frequency calculation methods use various types of time windows and filtering methods in order to accurately calculate grid frequency. Typically, these methods use a window on the order of 100 milliseconds (6 cycles). Thus, a delay of 100 milliseconds would occur even if the protective relay algorithm has no intentional time delay. This delay should be reflected in the standard. Also, the IRPTF identified that erroneous tripping due to frequency calculation errors was a significant factor in the Blue Cut Fire

⁴ The NERC Rules of Procedure require a technical justification for new or substantially revised Reliability Standards. Please attach pertinent information to this form before submittal to NERC.

Requested information

disturbance. Eliminating instantaneous tripping for frequency disturbances reduces the probability of incorrect tripping due to spurious noise in the measure voltage, for example during the period of fault clearing.

3. Point #5 in the Curve Details section of the “Voltage Ride-Through Curve Clarifications” (page 11 of PRC-024-2) states, “voltages in the curve assume minimum fundamental frequency phase to ground or phase to phase voltage for the low duration curve and the greater of maximum RMS (Root Mean Square) or crest phase to phase voltage for the high voltage duration curve.” There are a number of ways this can be interpreted, and issues that need to be addressed.
4. To minimize the probability of incorrect tripping (as noted in point 2 above), any voltage compared with the PRC-024-2 voltage ride through curves should be a well-filtered, fundamental frequency component of the voltage waveform. This will filter out spurious voltage spikes caused by switching action on the BPS. Voltage protective relays should not operate at the voltage levels specified in the voltage ride-through curve using instantaneously sampled values. The clarification should focus on using the RMS value of the voltage, and that the voltage signal should be adequately filtered to obtain this fundamental component.
5. The overvoltage component of the clarification states, “the greater of maximum RMS or crest phase to phase voltage”. The crest value is greater than the RMS value of a periodic waveform, so there is ambiguity regarding which value to apply. Without clarification, inverter based resources may trip based on different criteria. Failure to address this may lead to reliability issues, as identified in the Canyon 2 Fire disturbance analysis report.
6. Only phase to phase voltage is used for the high voltage component of the PRC-024-2 curve. However, inverter-based resource transient overvoltage protection may be based on phase to ground voltage as well. Use of phase to ground voltage for overvoltage protection needs to be considered.
7. Point #1 of the Curve Details section of the “Voltage Ride-Through Curve Clarifications” on page 11 of PRC-024-2 states, “the per unit voltage base for these curves is the nominal operating voltage specified by the Transmission Planner in the analysis of the reliability of the Interconnected Transmission Systems at the point of interconnection to the Bulk Electric System (BES).” Firstly, the Transmission Planner does not specify nominal operating voltage. Regardless, the per unit base for the curves should be based on the nominal voltage level that the generator is connected to at its Point of Interconnection. This is a static value and can be provided by the Transmission Planner.
8. Point #3 of the Curve Details section of the “Voltage Ride-Through Curve Clarifications” on page 11 of PRC-024-2 states, “The envelope within the curves represents the cumulative voltage duration at the point of interconnection with the BES.” The ride-through curves end at four seconds, and the curves imply a requirement for cumulative time duration for the “No Trip” zone. Protective relays and inverter protective functions within their control systems must be set to accommodate the cumulative nature of ride through curves. Under the current version of PRC-024-2, it is not explicitly clear at what point the cumulative values for the low and high

Requested information

voltage curves start, stop, and reset for multiple ride-through events. There are multiple ways to implement this cumulative effect, which result in different performance, for example during multiple, successive low voltage events. The correct methods for implementing the cumulative time duration should be clarified in PRC-024-2.⁵

9. The IRPTF identified that it is ambiguous and unclear as to whether the requirements of PRC-024-2 apply to the individual inverters. Footnote 1 does state that “protective functions within control systems that directly trip or provide tripping signals to the generator based on frequency or voltage inputs” are considered as part of the standard. Yet, the group acknowledged that the vagueness of the footnote as well as the synchronous generator-centric language in the requirements makes this confusing. There may exist multiple types of voltage and frequency protection, including relaying or individual inverter protective functions within their control systems that need to be considered in PRC-024-2. This should be clarified and strengthened throughout the standard.
10. Momentary cessation is a form of operation that some inverters have historically used during “ride-through” operation where voltage is outside the continuous operating range of the inverter. Momentary cessation is when zero current is injected into the grid by the inverter. This occurs because the power electronic firing commands are blocked so that the inverter does not produce current. Thus active and reactive current (and subsequently power) go to zero at the inverter terminals. The NERC IRPTF performed stability studies, particularly in the Western Interconnection, and demonstrated that the propagation and widespread use of momentary cessation, particularly at voltages within the PRC-024-2 voltage ride-through curve, could cause potential situations of instability. Both NERC Alerts following the Blue Cut Fire and Canyon 2 Fire gathered data related to the use of momentary cessation, and the latter NERC Alert explicitly recommended mitigating the use of momentary cessation to the best extent possible for existing and future resources. Clarifying PRC-024-2 relative to the use of momentary cessation within the “No Trip” zone of PRC-024-2 aligns with all these efforts. Momentary cessation within the “No Trip” zone of PRC-024-2 could be reported as an equipment limitation per Requirement R3.

Cost Impact Assessment, if known (Provide a paragraph describing the potential cost impacts associated with the proposed project):

This SAR proposes to clarify some issues and correct others. The cost impact is unknown, but in many cases is expected to be minimal (i.e., will only require changes to existing inverter control software and setting).

Please describe any unique characteristics of the BES facilities that may be impacted by this proposed standard development project (e.g. Dispersed Generation Resources):

Inverter-based resources including asynchronous ties may be impacted by this proposed standard development as Generator Owners, Transmission Owners and Original Equipment Manufacturers may

⁵ Example: One implementation considers one cumulative window timer for both low voltage and high voltage curves, and it starts when the voltage goes outside the continuous operating bounds. Another implementation considers separate cumulative timers and the HV timer starts when the voltage is greater than this curve and the LV timer starts when the voltage is less than that curve.

Requested information

need to change the control programming to enhance capabilities. Other generation resources may be impacted if the clarifications cause them to correct relay settings.

To assist the NERC Standards Committee in appointing a drafting team with the appropriate members, please indicate to which Functional Entities the proposed standard(s) should apply (e.g. Transmission Operator, Reliability Coordinator, etc. See the most recent version of the NERC Functional Model for definitions):

Generator Owners

Do you know of any consensus building activities⁶ in connection with this SAR? If so, please provide any recommendations or findings resulting from the consensus building activity.

Many of these proposals were developed by the NERC IRPTF, are outlined in the NERC Reliability Guideline: BPS-Connected Inverter-Based Resource Performance, and also captured in a white paper on potential standards gaps related to PRC-024-2. There were also similar proposals developed by the NERC IVGTF in 2015.

Are there any related standards or SARs that should be assessed for impact as a result of this proposed project? If so which standard(s) or project number(s)?

Are there alternatives (e.g. guidelines, white paper, alerts, etc.) that have been considered or could meet the objectives? If so, please list the alternatives.

The following materials have been developed by the NERC IRPTF, NERC Staff, and WECC Staff as part of the event analyses of inverter-based resources during BPS disturbances. However, these activities do not address the inconsistencies and technical issues of PRC-024-2 that have been highlighted in all these activities.

- Reliability Guideline: BPS-Connected Inverter-Based Resource Performance: https://www.nerc.com/comm/OC_Reliability_Guidelines_DL/Inverter-Based_Resource_Performance_Guideline.pdf.
- Blue Cut Fire Disturbance Report: <http://www.nerc.com/pa/rrm/ea/Pages/1200-MW-Fault-Induced-Solar-Photovoltaic-Resource-Interruption-Disturbance-Report.aspx>.
- Canyon 2 Fire Disturbance Report: <https://www.nerc.com/pa/rrm/ea/October%209%202017%20Canyon%20%20Fire%20Disturbance%20Report/900%20MW%20Solar%20Photovoltaic%20Resource%20Interruption%20Disturbance%20Report.pdf>.
- NERC Alert I: Loss of Solar Resources during Transmission Disturbances due to Inverter Settings: <https://www.nerc.com/pa/rrm/bpsa/Pages/Alerts.aspx>.
- NERC Alert II: Loss of Solar Resources during Transmission Disturbances due to Inverter Settings: <https://www.nerc.com/pa/rrm/bpsa/Pages/Alerts.aspx>.
- "NERC IVGTF Summary and Recommendation Report", published in June 2015. Relevant to PRC-024-02 are task 1-3 and 1-7: https://www.nerc.com/comm/PC/Integration%20of%20Variable%20Generation%20Task%20Force%201/IVGTF%20Summary%20and%20Recommendation%20Report_Final.pdf.

⁶ Consensus building activities are occasionally conducted by NERC and/or project review teams. They typically are conducted to obtain industry inputs prior to proposing any standard development project to revise, or develop a standard or definition.

Reliability Principles

Does this proposed standard development project support at least one of the following Reliability Principles ([Reliability Interface Principles](#))? Please check all those that apply.

<input checked="" type="checkbox"/>	1. Interconnected bulk power systems shall be planned and operated in a coordinated manner to perform reliably under normal and abnormal conditions as defined in the NERC Standards.
<input checked="" type="checkbox"/>	2. The frequency and voltage of interconnected bulk power systems shall be controlled within defined limits through the balancing of real and reactive power supply and demand.
<input type="checkbox"/>	3. Information necessary for the planning and operation of interconnected bulk power systems shall be made available to those entities responsible for planning and operating the systems reliably.
<input type="checkbox"/>	4. Plans for emergency operation and system restoration of interconnected bulk power systems shall be developed, coordinated, maintained and implemented.
<input type="checkbox"/>	5. Facilities for communication, monitoring and control shall be provided, used and maintained for the reliability of interconnected bulk power systems.
<input type="checkbox"/>	6. Personnel responsible for planning and operating interconnected bulk power systems shall be trained, qualified, and have the responsibility and authority to implement actions.
<input type="checkbox"/>	7. The security of the interconnected bulk power systems shall be assessed, monitored and maintained on a wide area basis.
<input type="checkbox"/>	8. Bulk power systems shall be protected from malicious physical or cyber attacks.

Market Interface Principles

Does the proposed standard development project comply with all of the following [Market Interface Principles](#)?

	Enter (yes/no)
1. A reliability standard shall not give any market participant an unfair competitive advantage.	Yes
2. A reliability standard shall neither mandate nor prohibit any specific market structure.	Yes
3. A reliability standard shall not preclude market solutions to achieving compliance with that standard.	Yes
4. A reliability standard shall not require the public disclosure of commercially sensitive information. All market participants shall have equal opportunity to access commercially non-sensitive information that is required for compliance with reliability standards.	Yes

Identified Existing or Potential Regional or Interconnection Variances

Region(s)/ Interconnection	Explanation
None	None

For Use by NERC Only

SAR Status Tracking (Check off as appropriate)	
<input type="checkbox"/> Draft SAR reviewed by NERC Staff	<input type="checkbox"/> Final SAR endorsed by the SC
<input type="checkbox"/> Draft SAR presented to SC for acceptance	<input type="checkbox"/> SAR assigned a Standards Project by NERC
<input type="checkbox"/> DRAFT SAR approved for posting by the SC	<input type="checkbox"/> SAR denied or proposed as Guidance document

Version History

Version	Date	Owner	Change Tracking
1	June 3, 2013		Revised
1	August 29, 2014	Standards Information Staff	Updated template
2	January 18, 2017	Standards Information Staff	Revised
2	June 28, 2017	Standards Information Staff	Updated template

Standard Development Timeline

This section is maintained by the drafting team during the development of the standard and will be removed when the standard is adopted by the NERC Board of Trustees (Board).

Description of Current Draft

PRC-024-3 is posted for a 45-day formal comment period with initial ballot.

Completed Actions	Date
Standards Committee approved Standard Authorization Request (SAR) for posting	December 2018
SAR posted for comment	December 19, 2018– January 19, 2019
Standards Committee accepted the revised SAR	February 20, 2019

Anticipated Actions	Date
45-day formal comment period with ballot	April – June 2019
45-day formal or informal comment period with additional ballot	July – August 2019
10-day final ballot	October 2019
Board adoption	November 2019

A. Introduction

1. **Title:** Generator Frequency and Voltage Protection Settings
2. **Number:** PRC-024-3
3. **Purpose:** To set generator protection, such that generating resource(s) remain connected, continuing to support the BES during defined frequency and voltage excursions.
4. **Applicability:**
 - 4.1. **Functional Entities:**
 - 4.1.1. Generator Owners that apply protection listed in Section 4.2.1.
 - 4.1.2. Transmission Owners that own a BES generator step-up (GSU) transformer or collector transformer and apply protection listed in Section 4.2.1.
 - 4.2. **Facilities:**
 - 4.2.1 Frequency, voltage or volts per hertz protection, including frequency or voltage protective functions within control systems that provide tripping or momentary cessation signals to all or part of the generating resource, applied to the following:
 - 4.2.1.1 Bulk Electric System (BES) generating resource(s).
 - 4.2.1.2 BES GSU transformer(s).
 - 4.2.1.3 High side of the generator-connected unit auxiliary transformer installed on BES generating resource(s).
 - 4.2.1.4 Individual dispersed power producing resources identified in the BES Definition, Inclusion I4.
 - 4.2.1.5 Elements utilized in aggregation of the dispersed power producing resources.
 - 4.2.1.6 Collector transformer of resources identified in the BES Definition, Inclusion I4.
5. **Effective Date:** See Implementation Plan for PRC-024-3

B. Requirements and Measures

- R1.** Each Generator Owner or Transmission Owner shall set its applicable frequency protection such that the generating resource does not trip or enter momentary cessation within the “no trip zone” of PRC-024 Attachment 1, subject to the following exception: *[Violation Risk Factor: Medium] [Time Horizon: Long-term Planning]*
- Generating resource(s) may be set to trip or enter momentary cessation within the “no trip zone” of PRC-024 Attachment 1 for documented and communicated regulatory or equipment limitations in accordance with Requirement R3.
- M1.** Each Generator Owner or Transmission Owner shall have evidence that the applicable frequency protection has been set in accordance with Requirement R1, such as dated setting sheets, calibration sheets, calculations, or other documentation.
- R2.** Each Generator Owner or Transmission Owner shall set its applicable voltage protection such that the generating resource does not trip or enter momentary cessation within the “no trip zone” of PRC-024 Attachment 2 during a voltage excursion at the high side of the GSU or collector transformer, subject to the following exceptions: *[Violation Risk Factor: Medium] [Time Horizon: Long-term Planning]*
- If the Transmission Planner allows less stringent voltage protection settings than those required to meet PRC-024 Attachment 2, then the Generator Owner or Transmission Owner may set its protection within the voltage recovery characteristics of a location-specific Transmission Planner’s study.
 - Generating resource(s) may trip or enter momentary cessation within a portion of the “no trip zone” of PRC-024 Attachment 2 for documented and communicated regulatory or equipment limitations in accordance with Requirement R3.
- M2.** Each Generator Owner or Transmission Owner shall have evidence that applicable voltage protection has been set in accordance with Requirement R2, such as dated setting sheets, voltage-time boundaries, calibration sheets, coordination plots, dynamic simulation studies, calculations, or other documentation.
- R3.** Each Generator Owner or Transmission Owner shall document each known regulatory or equipment limitation¹ that prevents an applicable generating resource(s) with generator frequency or voltage protection from meeting the protection setting criteria in Requirements R1 or R2, including (but not limited to) study results, experience from an actual event, or manufacturer’s advice. *[Violation Risk Factor: Lower] [Time Horizon: Long-term Planning]*
- 3.1.** The Generator Owner or Transmission Owner shall communicate the documented regulatory or equipment limitation, or the removal of a previously

¹ Excludes limitations that are caused by the setting capability of the generator frequency and voltage protection itself but does not exclude limitations originating in the equipment that it protects.

documented regulatory or equipment limitation, to its Planning Coordinator and Transmission Planner within 30 calendar days of any of the following:

- Identification of a regulatory or equipment limitation.
- Repair of the equipment causing the limitation that removes the limitation.
- Replacement of the equipment causing the limitation with equipment that removes the limitation.
- Creation or adjustment of an equipment limitation caused by consumption of the cumulative turbine life-time frequency excursion allowance.

M3. Each Generator Owner or Transmission Owner shall have evidence that it has documented and communicated any known regulatory or equipment limitations that resulted in an exception to Requirements R1 or R2 in accordance with Requirement R3, such as a dated email or letter that contains such documentation as study results, experience from an actual event, or manufacturer's advice.

R4. Each Generator Owner or Transmission Owner shall provide its applicable generator protection settings associated with Requirements R1 and R2 to the Planning Coordinator or Transmission Planner that models the associated generating resource(s) within 60 calendar days of receipt of a written request for the data and within 60 calendar days of any change to those previously requested settings unless directed by the requesting Planning Coordinator or Transmission Planner that the reporting of protection setting changes is not required. *[Violation Risk Factor: Lower]*
[Time Horizon: Operations Planning]

M4. Each Generator Owner or Transmission Owner shall have evidence that it communicated applicable generator protection settings in accordance with Requirement R4, such as dated e-mails, correspondence or other evidence and copies of any requests it has received for that information.

C. Compliance

1. Compliance Monitoring Process

1.1. Compliance Enforcement Authority: “Compliance Enforcement Authority” means NERC or the Regional Entity, or any entity as otherwise designated by an Applicable Governmental Authority, in their respective roles of monitoring and/or enforcing compliance with mandatory and enforceable Reliability Standards in their respective jurisdictions.

1.2. Evidence Retention: The following evidence retention period(s) identify the period of time an entity is required to retain specific evidence to demonstrate compliance. For instances where the evidence retention period specified below is shorter than the time since the last audit, the Compliance Enforcement Authority may ask an entity to provide other evidence to show that it was compliant for the full-time period since the last audit.

The applicable entity shall keep data or evidence to show compliance as identified below unless directed by its Compliance Enforcement Authority to retain specific evidence for a longer period of time as part of an investigation.

- The Generator Owner or Transmission Owner shall keep data or evidence of Requirements R1 through R4 for 3 years or until the next audit, whichever is longer.
- If a Generator Owner or Transmission Owner is found non-compliant, the Generator Owner or Transmission Owner shall keep information related to the non-compliance until mitigation is complete and approved for the time period specified above, whichever is longer.

1.3. Compliance Monitoring and Enforcement Program: As defined in the NERC Rules of Procedure, “Compliance Monitoring and Enforcement Program” refers to the identification of the processes that will be used to evaluate data or information for the purpose of assessing performance or outcomes with the associated Reliability Standard.

Violation Severity Levels

R #	Violation Severity Levels			
	Lower VSL	Moderate VSL	High VSL	Severe VSL
R1.	N/A	N/A	N/A	The Generator Owner or Transmission Owner failed to set its applicable frequency protection so that it does not trip or enter momentary cessation according to Requirement R1.
R2.	N/A	N/A	N/A	The Generator Owner or Transmission Owner failed to set its applicable voltage protection so that it does not trip or enter momentary cessation according to Requirement R2.
R3.	The Generator Owner or Transmission Owner documented the known non-protection system equipment limitation that prevented it from meeting the criteria in Requirement R1 or R2 and communicated the documented limitation to its Planning Coordinator and Transmission Planner more than 30 calendar days	The Generator Owner or Transmission Owner documented the known non-protection system equipment limitation that prevented it from meeting the criteria in Requirement R1 or R2 and communicated the documented limitation to its Planning Coordinator and Transmission Planner more than 60 calendar days	The Generator Owner or Transmission Owner documented the known non-protection system equipment limitation that prevented it from meeting the criteria in Requirement R1 or R2 and communicated the documented limitation to its Planning Coordinator and Transmission Planner more than 90 calendar days	The Generator Owner or Transmission Owner failed to document any known non-protection system equipment limitation that prevented it from meeting the criteria in Requirement R1 or R2. OR The Generator Owner or Transmission Owner failed to communicate the

R #	Violation Severity Levels			
	Lower VSL	Moderate VSL	High VSL	Severe VSL
	but less than or equal to 60 calendar days of identifying the limitation.	but less than or equal to 90 calendar days of identifying the limitation.	but less than or equal to 120 calendar days of identifying the limitation.	documented limitation to its Planning Coordinator and Transmission Planner within 120 calendar days of identifying the limitation.
R4.	<p>The Generator Owner or Transmission Owner provided its generator protection settings more than 60 calendar days but less than or equal to 90 calendar days of any change to those settings.</p> <p>OR</p> <p>The Generator Owner or Transmission Owner provided generator protection settings more than 60 calendar days but less than or equal to 90 calendar days of a written request.</p>	<p>The Generator Owner or Transmission Owner provided its generator protection settings more than 90 calendar days but less than or equal to 120 calendar days of any change to those settings.</p> <p>OR</p> <p>The Generator Owner or Transmission Owner provided generator protection settings more than 90 calendar days but less than or equal to 120 calendar days of a written request.</p>	<p>The Generator Owner or Transmission Owner provided its generator protection settings more than 120 calendar days but less than or equal to 150 calendar days of any change to those settings.</p> <p>OR</p> <p>The Generator Owner or Transmission Owner provided generator protection settings more than 120 calendar days but less than or equal to 150 calendar days of a written request.</p>	<p>The Generator Owner or Transmission Owner failed to provide its generator protection settings within 150 calendar days of any change to those settings.</p> <p>OR</p> <p>The Generator Owner or Transmission Owner failed to provide generator protection settings within 150 calendar days of a written request.</p>

D. Regional Variances

D.A. Variance for the Quebec Interconnection

This Interconnection-wide Variance shall be applicable in the Quebec Interconnection and replaces, in its entirety, continent-wide Requirement R2 with the following:

D.A.2. Each Generator Owner or Transmission Owner shall set its applicable voltage protection such that the generating resource does not trip or enter momentary cessation within the “no trip zone” of PRC-024 Attachment 2a during a voltage excursion at the high side of the GSU or collector transformer, subject to the following exceptions: *[Violation Risk Factor: Medium] [Time Horizon: Long-term Planning]*

- If the Transmission Planner allows less stringent voltage protection settings than those required to meet PRC-024 Attachment 2a, then the Generator Owner or Transmission Owner may set its protection within the voltage recovery characteristics of a location-specific Transmission Planner’s study.
- Generating resource(s) may trip or enter momentary cessation within a portion of the “no trip zone” of PRC-024 Attachment 2a for documented and communicated regulatory or equipment limitations in accordance with Requirement R3.
- Inverter-based resources voltage protection settings may be set to enter momentary cessation within the “no trip zone” of PRC-024 Attachment 2a during a voltage excursion at the high side of the MPT under the following conditions:
 - After a minimum delay of 0.022 s, when the positive-sequence voltage exceeds 1.25 per unit (p.u.) Normal operation must resume once the voltage drops back below 1.25 p.u.
 - After a minimum delay of 0.022 s, when the phase-to-ground root mean square (RMS) voltages exceeds 1.4 p.u., as measured at generator terminals, on one or multiple phases. Normal operation must resume once the voltage drops back below the 1.25 p.u.

M.D.A.2. Each Generator Owner or Transmission Owner shall have evidence that applicable voltage protection has been set in accordance with Requirement R2, such as dated setting sheets, voltage-time boundaries, calibration sheets, coordination plots, dynamic simulation studies, calculations, or other documentation.

E. Associated Documents

Implementation Plan

[Industry Recommendation I – Loss of Solar Resources during Transmission Disturbances Due to Inverter Settings](#)

[Industry Recommendation II – Loss of Solar Resources during Transmission Disturbances due to Inverter Settings](#)

[Blue Cut Fire Disturbance](#)

[Canyon 2 Fire Disturbance](#)

“Protective Relaying For Power Generation Systems”, Boca Raton, FL, Taylor & Francis, 2006, Reimert, Donald

“IEEE C37.102 IEEE Guide for AC Generator Protection”

“IEEE C50.13 IEEE Standard for Cylindrical-Rotor 50 Hz and 60 Hz Synchronous Generators Rated 10 MVA and Above”

“IEEE C37.106 IEEE Guide for Abnormal Frequency Protection for Power Generating Plants”

Version History

Version	Date	Action	Change Tracking
1	May 9, 2013	Adopted by the NERC Board of Trustees	
1	March 20, 2014	FERC Order issued approving PRC-024-1. (Order becomes effective on 7/1/16.)	
2	February 12, 2015	Adopted by the NERC Board of Trustees	Standard revised in Project 2014-01: Applicability revised to clarify application of requirements to BES dispersed power producing resources
2	May 29, 2015	FERC Letter Order in Docket No. RD15-3-000 approving PRC-024-2	Modifications to adjust the applicability to owners of dispersed generation resources.

Attachment 1 (Frequency No Trip Boundary by Interconnection)

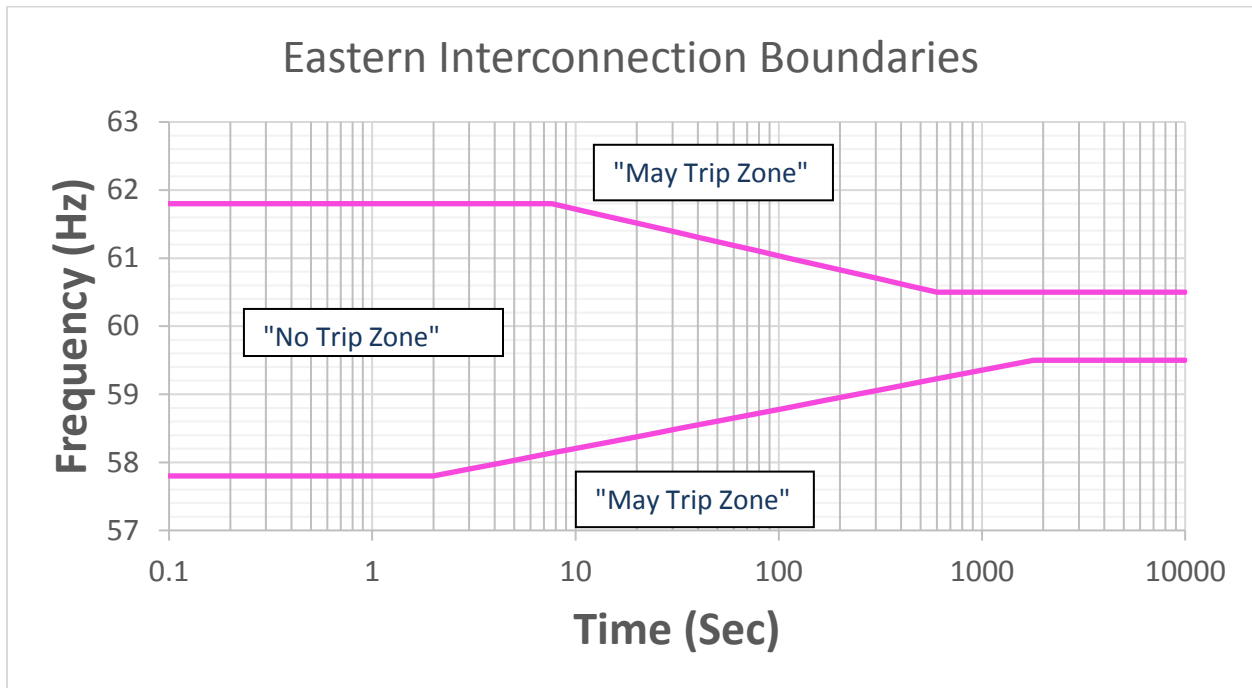

Figure 1

Frequency Boundary Data Points – Eastern Interconnection

High Frequency Duration		Low Frequency Duration	
Frequency (Hz)	Minimum Time (Sec)	Frequency (Hz)	Minimum Time (sec)
≥61.8	0.10	≤57.8	0.10
≥60.5	$10^{(90.935-1.45713*f)}$	≤59.5	$10^{(1.7373*f-100.116)}$
<60.5	Continuous operation	> 59.5	Continuous operation

Table 1

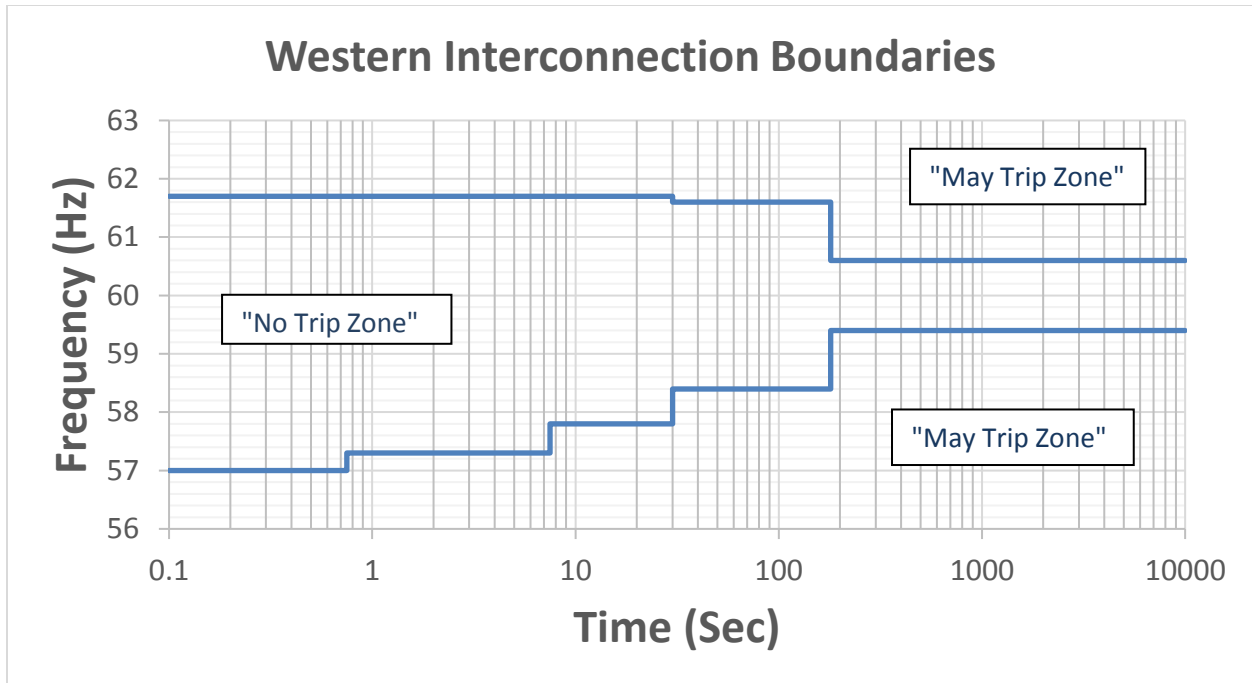

Figure 2

Frequency Boundary Data Points – Western Interconnection

High Frequency Duration		Low Frequency Duration	
Frequency (Hz)	Minimum Time (Sec)	Frequency (Hz)	Minimum Time (sec)
≥61.7	0.10	≤57.0	0.10
≥61.6	30	≤57.3	0.75
≥60.6	180	≤57.8	7.5
<60.6	Continuous operation	≤58.4	30
		≤59.4	180
		>59.4	Continuous operation

Table 3

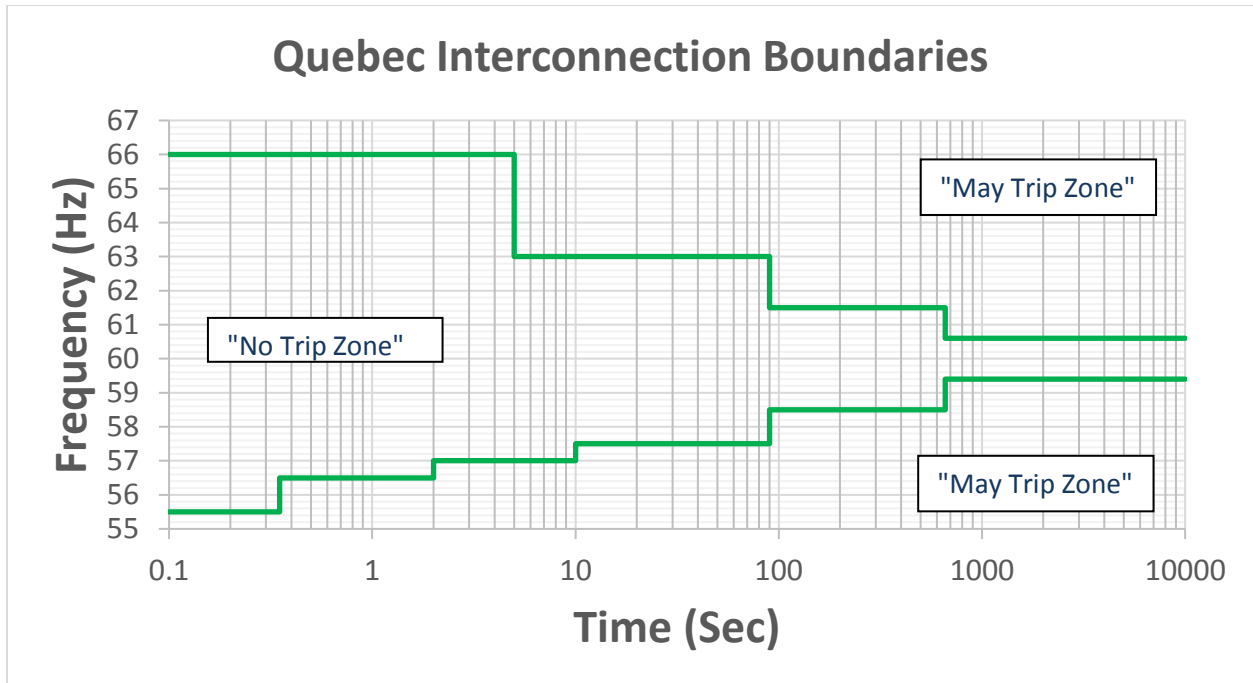

Figure 4

Frequency Boundary Data Points – Quebec Interconnection

High Frequency Duration		Low Frequency Duration	
Frequency (Hz)	Minimum Time (Sec)	Frequency (Hz)	Minimum Time (Sec)
>66.0	0.10	<55.5	0.10
≥63.0	5	≤56.5	0.35
≥61.5	90	≤57.0	2
≥60.6	660	≤57.5	10
<60.6	Continuous operation	≤58.5	90
		≤59.4	660
		>59.4	Continuous operation

Table 2

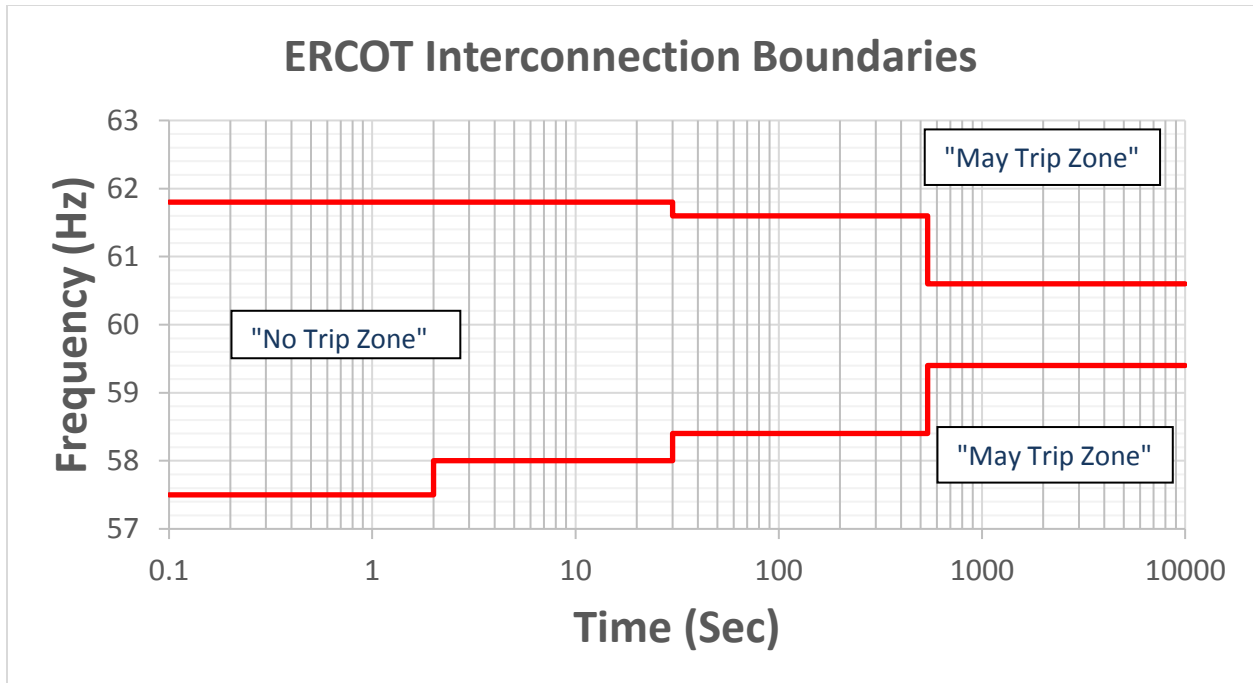

Figure 5

Frequency Boundary Data Points – ERCOT Interconnection

High Frequency Duration		Low Frequency Duration	
Frequency (Hz)	Minimum Time (Sec)	Frequency (Hz)	Minimum Time (sec)
≥61.8	0.10	≤57.5	0.10
≥61.6	30	≤58.0	2
≥60.6	540	≤58.4	30
<60.6	Continuous operation	≤59.4	540
		>59.4	Continuous operation

Table 3

PRC-024— Attachment 2 (Voltage No-Trip Boundary – Eastern, Western, and ERCOT Interconnections)

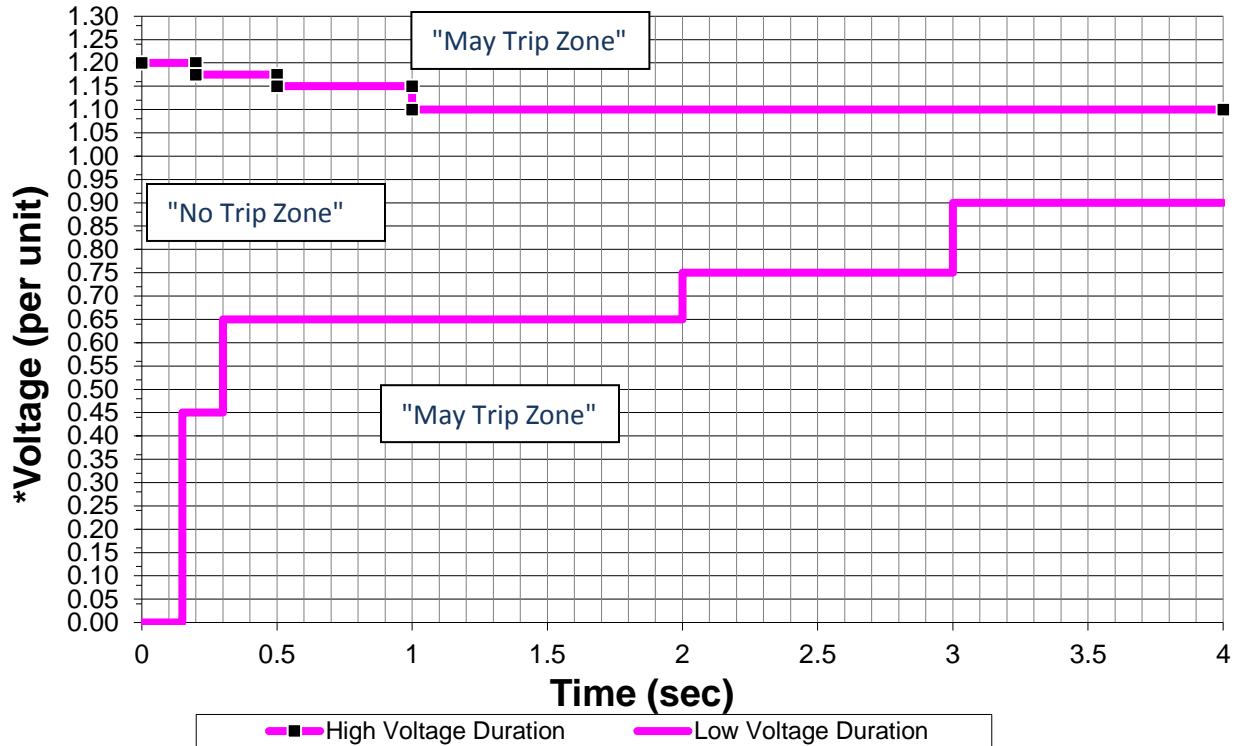

Figure 1

Voltage Boundary Data Points

High Voltage Duration		Low Voltage Duration	
Voltage (pu)	Minimum Time (sec)	Voltage (pu)	Minimum Time (sec)
≥1.200	0.00	<0.45	0.15
≥1.175	0.20	<0.65	0.30
≥1.15	0.50	<0.75	2.00
≥1.10	1.00	<0.90	3.00
<1.10	4.00	≥ 0.90	4.00

Table 1

* Voltage at the high-side of the GSU or collector transformer.

Voltage Boundary Clarifications – Eastern, Western, and ERCOT Interconnections

Boundary Details:

1. The per unit voltage base for these boundaries is the nominal operating voltage (e.g., 115 kV, 138 kV, 230 kV, 345 kV, 500 kV, etc.).
2. The boundaries apply to voltage excursions regardless of the type of initiating event.
3. The values in the table represent the minimum time durations allowed for specified voltage excursion thresholds.
4. The boundaries assume a system frequency of 60 Hertz. When evaluating volts per hertz protection, magnitude of the high voltage boundary can be adjusted in proportion to deviations of frequency below 60 Hertz.
5. Voltages in the boundaries assume RMS fundamental frequency phase-to-ground or phase-to-phase voltage.
6. The “no trip zone” ends at 4 seconds.

Evaluating Protection Settings:

1. Use either the following assumptions or loading conditions that are believed to be the most probable for the unit under study to evaluate voltage protection setting calculations on the static case for steady state initial conditions:
 - a. All of the units connected to the same transformer are online and operating.
 - b. All of the units are at full nameplate real-power output.
 - c. Power factor is 0.95 lagging (i.e. supplying reactive power to the system) as measured at the generator terminals.
 - d. The automatic voltage regulator is in automatic voltage control mode.
2. Evaluate voltage protection settings assuming that additional installed generating plant reactive support equipment (such as static VAR compensators, synchronous condensers, or capacitors) is available and operating normally.
3. Evaluate voltage protection settings accounting for the actual tap settings of transformers between the generator terminals and the high side of the GSU or collector transformer.

PRC-024— Attachment 2a (Voltage No Trip Boundaries – Quebec Interconnection)

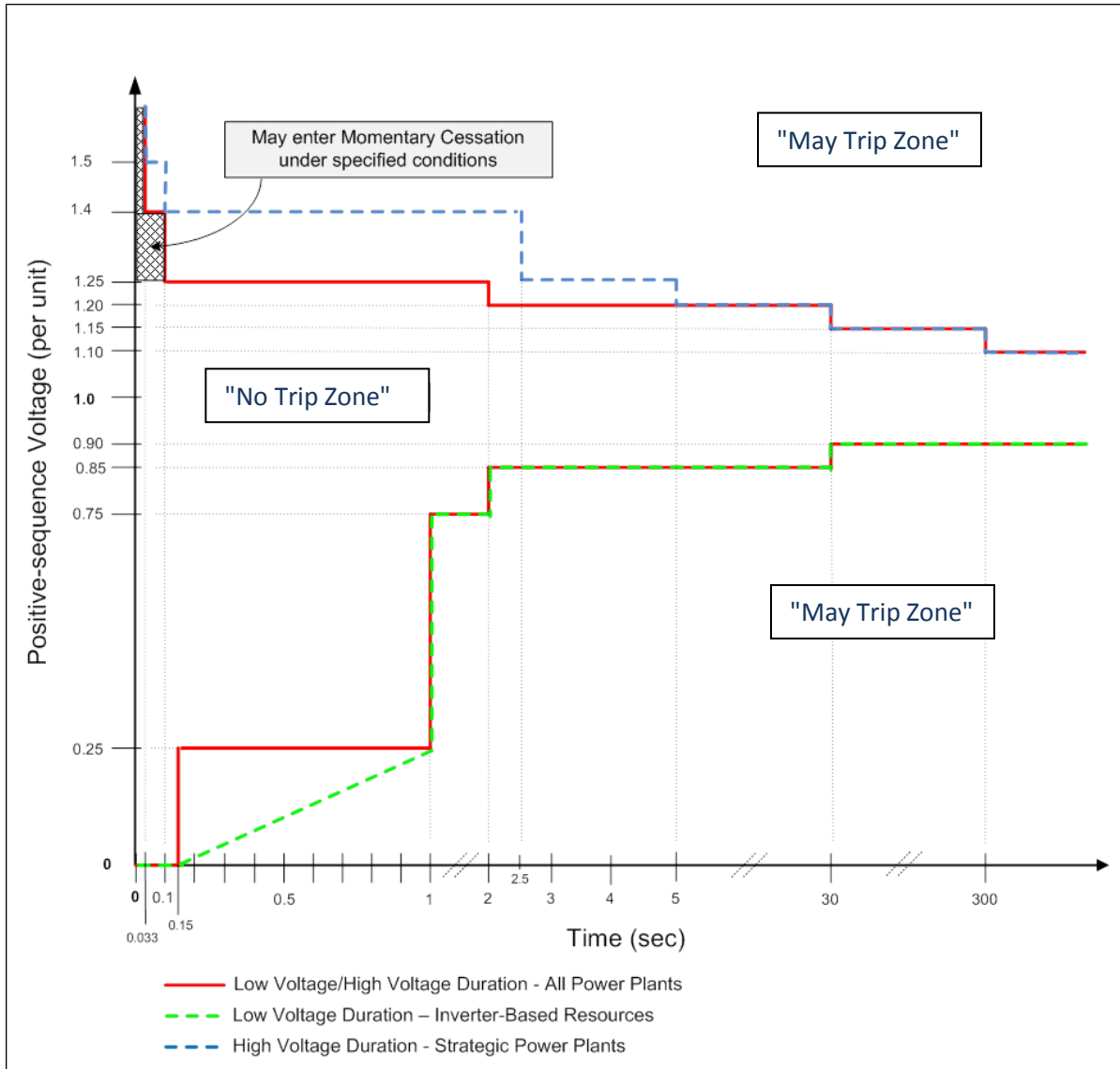

Figure 1

Voltage Boundary Data Points – Quebec Interconnection

High Voltage Duration for all Power Plants		High Voltage Duration for strategic ¹ Power Plants	
Voltage (pu)	Minimum Time (sec)	Voltage (pu)	Minimum Time (sec)
---	---	>1.50	0.033
>1.40	0.033	>1.40	0.10
>1.25	0.10	>1.25	2.50
>1.20	2.00	>1.20	5.00
>1.15	30	>1.15	30
>1.10	300	>1.10	300
≤1.10	continuous	≤1.10	continuous

Table 1

Voltage Boundary Data Points – Quebec Interconnection

Low Voltage Duration for all Power Plants		Low Voltage Duration for Inverter-Based Resources	
Voltage (pu)	Minimum Time (sec)	Voltage (pu)	Minimum Time (sec)
<0.25	0.15	<0.25	$3.4 * V(\text{pu}) + 0.15$
<0.75	1.00	<0.75	1.00
<0.85	2.00	<0.85	2.00
<0.90	30	<0.90	30
≥0.90	continuous	≥0.90	continuous

Table 2

¹ Power Plants designated by the Transmission Planner for protecting the integrity of Transmission System equipment.

Voltage Boundary Clarifications – Quebec Interconnection

Boundary Details:

1. The per unit voltage base for these boundaries is the nominal operating voltage (e.g., 115 kV, 138 kV, 230 kV, 345 kV, 500 kV, etc.).
2. The boundaries apply to voltage excursions regardless of the type of initiating event.
3. The values in the table represent the minimum time durations allowed for specified voltage excursion thresholds.
4. The boundaries assume a system frequency of 60 Hertz. When evaluating volts per hertz protection, magnitude of the high voltage boundary can be adjusted in proportion to deviations of frequency below 60 Hertz.
5. Voltages in the boundaries assume positive-sequence values.

Evaluating Protection Settings:

1. Use either the following assumptions or loading conditions that are believed to be the most probable for the unit under study to evaluate voltage protection setting calculations on the static case for steady state initial conditions:
 - a. All of the units connected to the same transformer are online and operating.
 - b. All of the units are at full nameplate real-power output.
 - c. Power factor is 0.95 lagging (i.e. supplying reactive power to the system) as measured at the generator terminals.
 - d. The automatic voltage regulator is in automatic voltage control mode.
2. Evaluate voltage protection settings assuming that additional installed generating plant reactive support equipment (such as static VAR compensators, synchronous condensers, or capacitors) is available and operating normally.
3. Evaluate voltage protection settings accounting for the actual tap settings of transformers between the generator terminals and the high side of the GSU or collector transformer.

Standard Development Timeline

This section is maintained by the drafting team during the development of the standard and will be removed when the standard is adopted by the NERC Board of Trustees (Board).

Description of Current Draft

PRC-024-3 is posted for a 45-day formal comment period with initial ballot.

Completed Actions	Date
Standards Committee approved Standard Authorization Request (SAR) for posting	December 2018
SAR posted for comment	December 19, 2018 – January 19, 2019
Standards Committee accepted the revised SAR	February 20, 2019

Anticipated Actions	Date
45-day formal or informal comment period with ballot	April – June 2019
45-day formal or informal comment period with additional ballot	July – August 2019
10-day final ballot	October 2019
Board adoption	November 2019

A. Introduction

1. **Title:** Generator Frequency and Voltage ~~Protection Protective Relay~~ Settings
2. **Number:** ~~PRC-024-3~~ PRC-024-2
3. **Purpose:** ~~Ensure Generator Owners To set their generator protection, protective relays~~ such that generating ~~resource(s) units~~ remain connected, continuing to support the BES during defined frequency and voltage excursions.
4. **Applicability:**
 - 4.1. Generator Owner Functional Entities:
 - 4.1.1. Generator Owners that apply protection listed in Section 4.2.1.
 - 4.1.2. Transmission Owners that own a BES generator step-up (GSU) transformer or collector transformer and apply protection listed in Section 4.2.1.
 - 4.2. Facilities:
 - 4.2.1 Frequency, voltage or volts per hertz protection, including frequency or voltage protective functions within control systems that provide tripping or momentary cessation signals to all or part of the generating resource, applied to the following:
 - 4.2.1.1 Bulk Electric System (BES) generating resource(s).
 - 4.2.1.2 BES GSU transformer(s).
 - 4.2.1.3 High side of the generator-connected unit auxiliary transformer installed on BES generating resource(s).
 - 4.2.1.4 Individual dispersed power producing resources identified in the BES Definition, Inclusion I4.
 - 4.2.1.5 Elements utilized in aggregation of the dispersed power producing resources.
 - 4.2.1.6 Collector transformer of resources identified in the BES Definition, Inclusion I4.
5. **Effective Date:** See Implementation Plan for ~~PRC-024-2~~ PRC-024-3

B. Requirements and Measures

- R1.** Each Generator Owner or Transmission Owner that has generator frequency ~~protective relaying¹ activated to trip its applicable generating unit(s)~~ shall set its applicable frequency protection protective relaying such that ~~the the generator frequency protective relaying~~ generating resource does not trip or enter momentary cessation the applicable generating unit(s) within the “no trip zone” of PRC-024 Attachment 1, subject to the following exceptions²: [*Violation Risk Factor: Medium*] [*Time Horizon: Long-term Planning*]
- ~~Generating unit(s) may trip if the protective functions (such as out-of-step functions or loss of field functions) operate due to an impending or actual loss of synchronism or, for asynchronous generating units, due to instability in power conversion control equipment.~~
 - ~~Generating unit(s) may trip if clearing a system fault necessitates disconnecting (a) generating unit(s).~~
 - Generating resource(s) unit(s) may be set to trip or enter momentary cessation within a portion of the “no trip zone” of PRC-024 Attachment 1 for documented and communicated regulatory or equipment limitations in accordance with Requirement R3.
- M1.** Each Generator Owner or Transmission Owner shall have evidence that the applicable frequency protection has generator frequency protective relays have been set in accordance with Requirement R1, such as dated setting sheets, calibration sheets, calculations, or other documentation.
- R2.** Each Generator Owner or Transmission Owner that has generator voltage protective ~~relaying¹ activated to trip its applicable generating unit(s)~~ shall set its protective relaying applicable voltage protection such that the generator voltage protective relaying generating resource does not trip or enter momentary cessation within the “no trip zone” of PRC-024 Attachment 2 the applicable generating unit(s) as a result of a during a voltage excursion at the high side of the GSU or collector transformer, subject to the following exceptions: [Violation Risk Factor: Medium] [Time Horizon: Long-term Planning] (at the point of interconnection³) caused by an event on the

¹Each Generator Owner is not required to have frequency or voltage protective relaying (including but not limited to frequency and voltage protective functions for discrete relays, volts per hertz relays evaluated at nominal frequency, multi-function protective devices or protective functions within control systems that directly trip or provide tripping signals to the generator based on frequency or voltage inputs) installed or activated on its unit.

²For frequency protective relays associated with dispersed power producing resources identified through Inclusion I4 of the Bulk Electric System definition, this requirement applies to frequency protective relays applied on the individual generating unit of the dispersed power producing resources, as well as frequency protective relays applied on equipment from the individual generating unit of the dispersed power producing resource up to the point of interconnection.

~~transmission system external to the generating plant that remains within the “no trip zone” of PRC-024 Attachment 2.⁴~~

- If the Transmission Planner allows less stringent voltage relay protection settings than those required to meet PRC-024 Attachment 2, then the Generator Owner or Transmission Owner may shall set its protection protective relaying within the voltage recovery characteristics of a location-specific Transmission Planner’s study. ~~Requirement R2 is subject to the following exceptions: [Violation Risk Factor: Medium] [Time Horizon: Long term Planning]~~
- ~~Generating unit(s) may trip in accordance with a Special Protection System (SPS) or Remedial Action Scheme (RAS).~~
- ~~Generating unit(s) may trip if clearing a system fault necessitates disconnecting (a) generating unit(s).~~
- ~~Generating unit(s) may trip by action of protective functions (such as out-of-step functions or loss-of-field functions) that operate due to an impending or actual loss of synchronism or, for asynchronous generating units, due to instability in power conversion control equipment.~~
- Generating resource(s) unit(s) may trip or enter momentary cessation within a portion of the “no trip zone” of PRC-024 Attachment 2 for documented and communicated regulatory or equipment limitations in accordance with Requirement R3.

M2. Each Generator Owner or Transmission Owner shall have evidence that applicable generator voltage protection has~~protective relays have~~ been set in accordance with Requirement R2, such as dated setting sheets, voltage-time boundaries, calibration sheets, coordination plots, dynamic simulation studies, calculations, or other documentation.

R3. Each Generator Owner or Transmission Owner shall document each known regulatory or equipment limitation⁵ that prevents an applicable generating resource(s) unit with generator frequency or voltage protective relaysprotection from meeting the relay protection setting criteria in Requirements R1 or R2, including (but not limited to)

³For the purposes of this standard, point of interconnection means the transmission (high voltage) side of the generator step-up or collector transformer.

⁴For voltage protective relays associated with dispersed power producing resources identified through Inclusion I4 of the Bulk Electric System definition, this requirement applies to voltage protective relays applied on the individual generating unit of the dispersed power producing resources, as well as voltage protective relays applied on equipment from the individual generating unit of the dispersed power producing resource up to the point of interconnection.

⁵ Excludes limitations that are caused by the setting capability of the generator frequency and voltage protection protective relays themselves itself but does not exclude limitations originating in the equipment that they it protects.

study results, experience from an actual event, or manufacturer’s advice. *[Violation Risk Factor: Lower] [Time Horizon: Long-term Planning]*

3.1. The Generator Owner or Transmission Owner shall communicate the documented regulatory or equipment limitation, or the removal of a previously documented regulatory or equipment limitation, to its Planning Coordinator and Transmission Planner within 30 calendar days of any of the following:

- Identification of a regulatory or equipment limitation.
- Repair of the equipment causing the limitation that removes the limitation.
- Replacement of the equipment causing the limitation with equipment that removes the limitation.
- Creation or adjustment of an equipment limitation caused by consumption of the cumulative turbine life-time frequency excursion allowance.

M3. Each Generator Owner or Transmission Owner shall have evidence that it has documented and communicated any known regulatory or equipment limitations ~~(excluding limitations noted in footnote 3)~~ that resulted in an exception to Requirements R1 or R2 in accordance with Requirement R3, such as a dated email or letter that contains such documentation as study results, experience from an actual event, or manufacturer’s advice.

R4. Each Generator Owner or Transmission Owner shall provide its applicable generator protection ~~trip~~-settings associated with Requirements R1 and R2 to the Planning Coordinator or Transmission Planner that models the associated generating resource(s) unit within 60 calendar days of receipt of a written request for the data and within 60 calendar days of any change to those previously requested ~~trip~~-settings unless directed by the requesting Planning Coordinator or Transmission Planner that the reporting of relay-protection setting changes is not required. *[Violation Risk Factor: Lower] [Time Horizon: Operations Planning]*

M4. Each Generator Owner or Transmission Owner shall have evidence that it communicated applicable generator protective-relay trip-protection settings in accordance with Requirement R4, such as dated e-mails, correspondence or other evidence and copies of any requests it has received for that information.

C. Compliance

1. Compliance Monitoring Process

1.1. Compliance Enforcement Authority: “Compliance Enforcement Authority” means NERC or the Regional Entity, or any entity as otherwise designated by an Applicable Governmental Authority, in their respective roles of monitoring and/or enforcing compliance with mandatory and enforceable Reliability Standards in their respective jurisdictions.

- 1.2. Evidence Retention:** The following evidence retention period(s) identify the period of time an entity is required to retain specific evidence to demonstrate compliance. For instances where the evidence retention period specified below is shorter than the time since the last audit, the Compliance Enforcement Authority may ask an entity to provide other evidence to show that it was compliant for the full-time period since the last audit.

The applicable entity shall keep data or evidence to show compliance as identified below unless directed by its Compliance Enforcement Authority to retain specific evidence for a longer period of time as part of an investigation.

- The Generator Owner or Transmission Owner shall keep data or evidence of Requirements R1 through R4 for 3 years or until the next audit, whichever is longer.
- If a Generator Owner or Transmission Owner is found non-compliant, the Generator Owner or Transmission Owner shall keep information related to the non-compliance until mitigation is complete and approved for the time period specified above, whichever is longer.

- 1.3. Compliance Monitoring and Enforcement Program:** As defined in the NERC Rules of Procedure, “Compliance Monitoring and Enforcement Program” refers to the identification of the processes that will be used to evaluate data or information for the purpose of assessing performance or outcomes with the associated Reliability Standard.

Violation Severity Levels

R #	Violation Severity Levels			
	Lower VSL	Moderate VSL	High VSL	Severe VSL
R1.	N/A	N/A	N/A	The Generator Owner <u>or</u> <u>Transmission Owner</u> that has frequency protection activated to trip a generating unit, failed to set its <u>applicable generator frequency protection protective relaying</u> so that it does not trip <u>or enter momentary cessation</u> within the criteria listed in <u>according to Requirement R1,</u> unless there is a documented and communicated regulatory or equipment limitation per Requirement R3.
R2.	N/A	N/A	N/A	The Generator Owner <u>or</u> <u>Transmission Owner</u> with voltage protective relaying activated to trip a generating unit, failed to set its <u>applicable voltage protection protective relaying</u> so that it does not trip <u>or enter momentary cessation</u> as a result of a voltage excursion

R #	Violation Severity Levels			
	Lower VSL	Moderate VSL	High VSL	Severe VSL
				at the point of interconnection, caused by an event external to the plant per the criteria specified in according to Requirement R2. unless there is a documented and communicated regulatory or equipment limitation per Requirement R3.
R3.	The Generator Owner <u>or</u> <u>Transmission Owner</u> documented the known non-protection system equipment limitation that prevented it from meeting the criteria in Requirement R1 or R2 and communicated the documented limitation to its Planning Coordinator and Transmission Planner more than 30 calendar days but less than or equal to 60 calendar days of identifying the limitation.	The Generator Owner <u>or</u> <u>Transmission Owner</u> documented the known non-protection system equipment limitation that prevented it from meeting the criteria in Requirement R1 or R2 and communicated the documented limitation to its Planning Coordinator and Transmission Planner more than 60 calendar days but less than or equal to 90 calendar days of identifying the limitation.	The Generator Owner <u>or</u> <u>Transmission Owner</u> documented the known non-protection system equipment limitation that prevented it from meeting the criteria in Requirement R1 or R2 and communicated the documented limitation to its Planning Coordinator and Transmission Planner more than 90 calendar days but less than or equal to 120 calendar days of identifying the limitation.	The Generator Owner <u>or</u> <u>Transmission Owner</u> failed to document any known non-protection system equipment limitation that prevented it from meeting the criteria in Requirement R1 or R2. OR The Generator Owner <u>or</u> <u>Transmission Owner</u> failed to communicate the documented limitation to its Planning Coordinator and

R #	Violation Severity Levels			
	Lower VSL	Moderate VSL	High VSL	Severe VSL
				Transmission Planner within 120 calendar days of identifying the limitation.
R4.	<p>The Generator Owner <u>or</u> <u>Transmission Owner</u> provided its generator protection settings more than 60 calendar days but less than or equal to 90 calendar days of any change to those settings.</p> <p>OR</p> <p>The Generator Owner <u>or</u> <u>Transmission Owner</u> provided generator protection settings more than 60 calendar days but less than or equal to 90 calendar days of a written request.</p>	<p>The Generator Owner <u>or</u> <u>Transmission Owner</u> provided its generator protection settings more than 90 calendar days but less than or equal to 120 calendar days of any change to those settings.</p> <p>OR</p> <p>The Generator Owner <u>or</u> <u>Transmission Owner</u> provided generator protection settings more than 90 calendar days but less than or equal to 120 calendar days of a written request.</p>	<p>The Generator Owner <u>or</u> <u>Transmission Owner</u> provided its generator protection settings more than 120 calendar days but less than or equal to 150 calendar days of any change to those settings.</p> <p>OR</p> <p>The Generator Owner <u>or</u> <u>Transmission Owner</u> provided generator protection settings more than 120 calendar days but less than or equal to 150 calendar days of a written request.</p>	<p>The Generator Owner failed to provide its generator protection settings within 150 calendar days of any change to those settings.</p> <p>OR</p> <p>The Generator Owner or <u>Transmission Owner</u> failed to provide generator protection settings within 150 calendar days of a written request.</p>

R #	Violation Severity Levels			
	Lower VSL	Moderate VSL	High VSL	Severe VSL

D. Regional Variances

D.A. Variance for the Quebec Interconnection

This Interconnection-wide Variance shall be applicable in the Quebec Interconnection and replaces-, in its entirety, continent-wide Requirement R2 with the following:

D.A.2. Each Generator Owner or Transmission Owner shall set its applicable voltage protection such that the generating resource does not trip or enter momentary cessation within the “no trip zone” of PRC-024 Attachment 2a during a voltage excursion at the high side of the GSU or collector transformer, subject to the following exceptions:
[Violation Risk Factor: Medium] [Time Horizon: Long-term Planning]

- If the Transmission Planner allows less stringent voltage protection settings than those required to meet PRC-024 Attachment 2a, then the Generator Owner or Transmission Owner may set its protection- within the voltage recovery characteristics of a location-specific Transmission Planner’s study.
- Generating resource(s) may trip or enter momentary cessation within a portion of the “no trip zone” of PRC-024 Attachment 2a for documented and communicated regulatory or equipment limitations in accordance with Requirement R3.
- Inverter-based resources voltage protection settings may be set to enter momentary cessation within the “no trip zone” of PRC-024 Attachment 2a during a voltage excursion at the high side of the MPT under the following conditions:
 - After a minimum delay of 0.022 s, when the positive-sequence voltage exceeds 1.25 per unit (p.u.) Normal operation must resume once the voltage drops back below 1.25 p.u.
 - After a minimum delay of 0.022 s, when the phase-to-ground RMS voltages exceeds 1.4p.u., as measured at generator terminals, on one or multiple phases. Normal operation must resume once the voltage drops back below the 1.25 p.u.

M.D.A.2. Each Generator Owner or Transmission Owner shall have evidence that applicable voltage protection has been set in accordance with Requirement R2 such as dated setting sheets, voltage-time boundaries, calibration sheets, coordination plots, dynamic simulation studies, calculations, or other documentation.

D.E. Associated Documents

Implementation Plan

Industry Recommendation I – Loss of Solar Resources during Transmission Disturbances Due to Inverter Settings

Industry Recommendation II – Loss of Solar Resources during Transmission Disturbances due to Inverter Settings

Blue Cut Fire Disturbance

Canyon 2 Fire Disturbance

“Protective Relaying For Power Generation Systems”, Boca Raton, FL, Taylor & Francis, 2006, Reimert, Donald

“IEEE C37.102 IEEE Guide for AC Generator Protection”

“IEEE C50.13 IEEE Standard for Cylindrical-Rotor 50 Hz and 60 Hz Synchronous Generators Rated 10 MVA and Above”

“IEEE C37.106 IEEE Guide for Abnormal Frequency Protection for Power Generating Plants”

Version History

Version	Date	Action	Change Tracking
1	May 9, 2013	Adopted by the NERC Board of Trustees	
1	March 20, 2014	FERC Order issued approving PRC-024-1. (Order becomes effective on 7/1/16.)	
2	February 12, 2015	Adopted by the NERC Board of Trustees	Standard revised in Project 2014-01: Applicability revised to clarify application of requirements to BES dispersed power producing resources
2	May 29, 2015	FERC Letter Order in Docket No. RD15-3-000 approving PRC-024-2	Modifications to adjust the applicability to owners of dispersed generation resources.

PRC-024 — Attachment 1

~~OFF NOMINAL FREQUENCY CAPABILITY CURVE~~

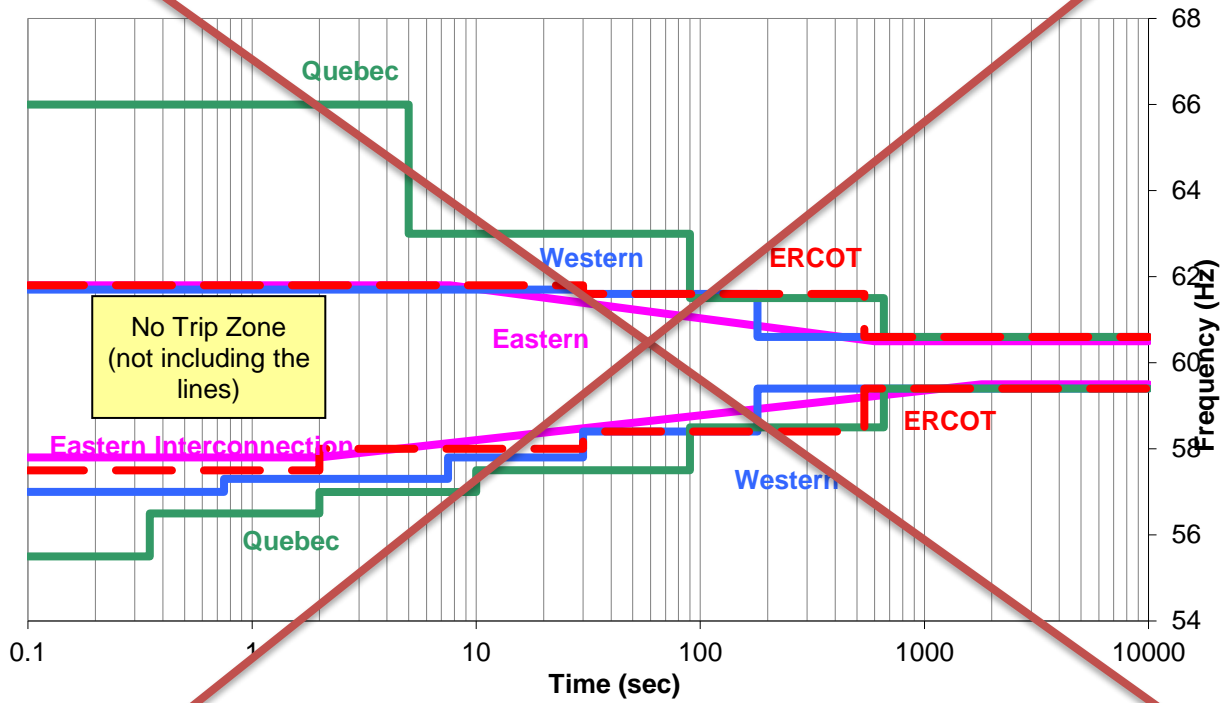

Attachment 1
OFF-NOMINAL FREQUENCY CAPABILITY CURVE
(Frequency No Trip Boundary by Interconnection)

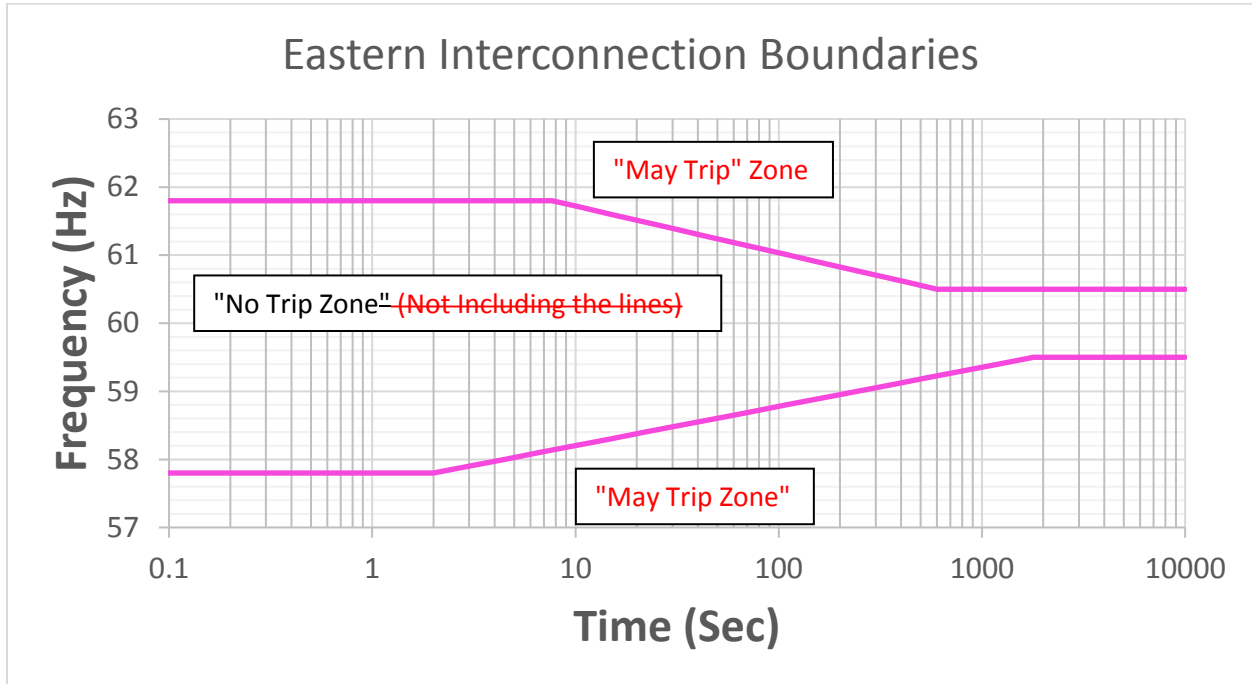

Figure 1

Curve-Frequency Boundary Data Points – Eastern Interconnection

High Frequency Duration		Low Frequency Duration	
Frequency (Hz)	<u>Minimum</u> Time (Sec)	Frequency (Hz)	<u>Minimum</u> Time (sec)
≥61.8	<u>0.10</u> Instantaneous trip	≤57.8	<u>0.10</u> Instantaneous trip
≥60.5	$10^{(90.935-1.45713*f)}$	≤59.5	$10^{(1.7373*f-100.116)}$
<60.5	Continuous operation	> 59.5	Continuous operation

Table 1

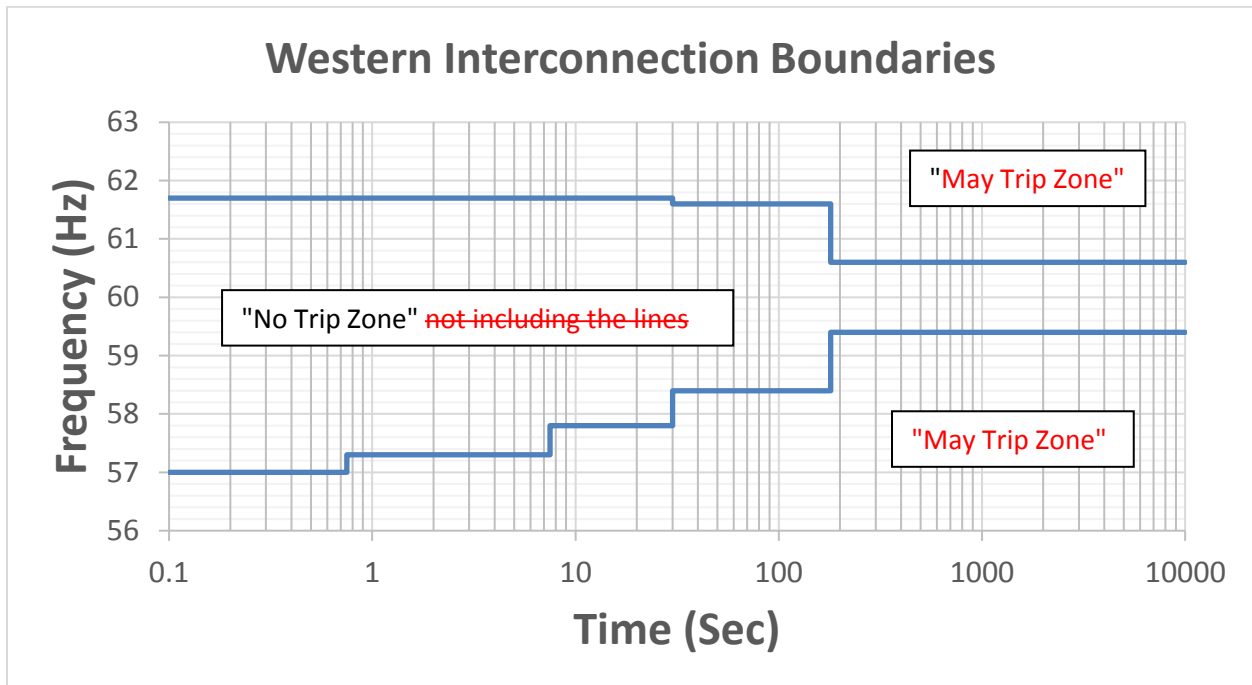

Figure 2

Curve Frequency- Boundary Data Points – Western Interconnection

High Frequency Duration		Low Frequency Duration	
Frequency (Hz)	<u>Minimum</u> Time (Sec)	Frequency (Hz)	<u>Minimum</u> Time (sec)
≥61.7	<u>0.10</u> Instantaneous trip	≤57.0	<u>0.10</u> Instantaneous trip
≥61.6	30	≤57.3	0.75
≥60.6	180	≤57.8	7.5
<60.6	Continuous operation	≤58.4	30
		≤59.4	180
		>59.4	Continuous operation

Table 3

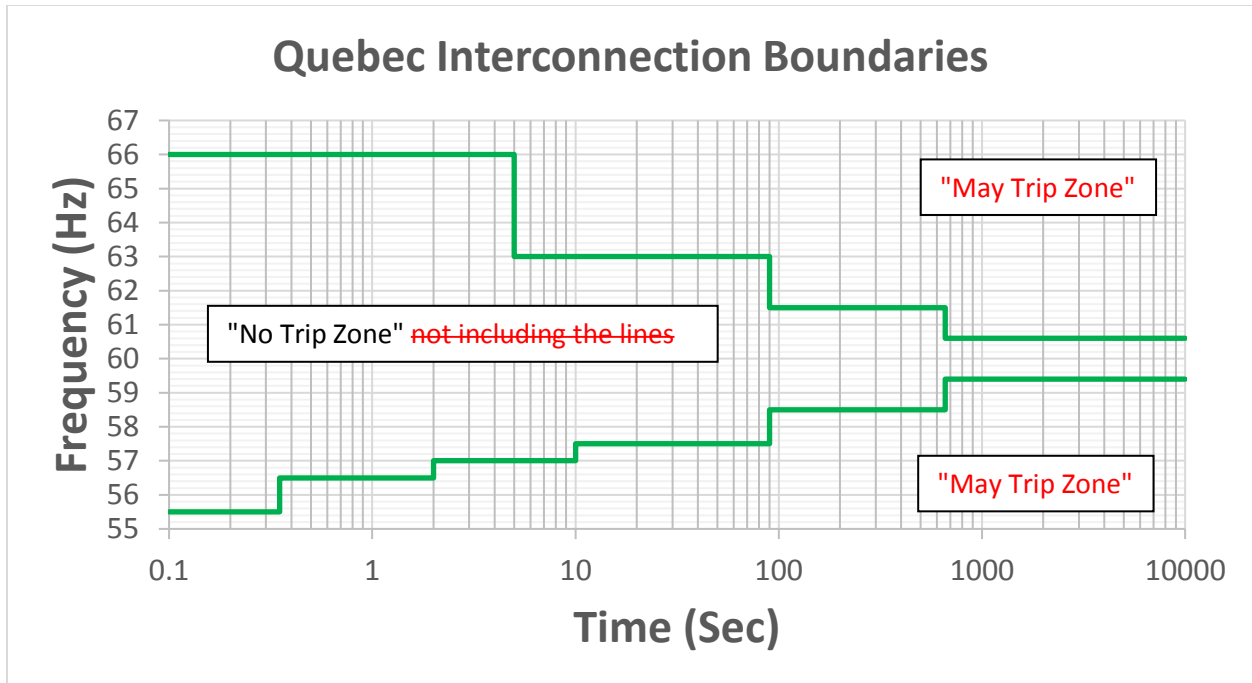

Figure 4

Curve-Frequency Boundary Data Points – Quebec Interconnection

High Frequency Duration		Low Frequency Duration	
Frequency (Hz)	<u>Minimum</u> Time (Sec)	Frequency (Hz)	<u>Minimum</u> Time (Sec)
>66.0	<u>0.10</u> Instantaneous trip	<55.5	<u>0.10</u> Instantaneous trip
≥63.0	5	≤56.5	0.35
≥61.5	90	≤57.0	2
≥60.6	660	≤57.5	10
<60.6	Continuous operation	≤58.5	90
		≤59.4	660
		>59.4	Continuous operation

Table 2

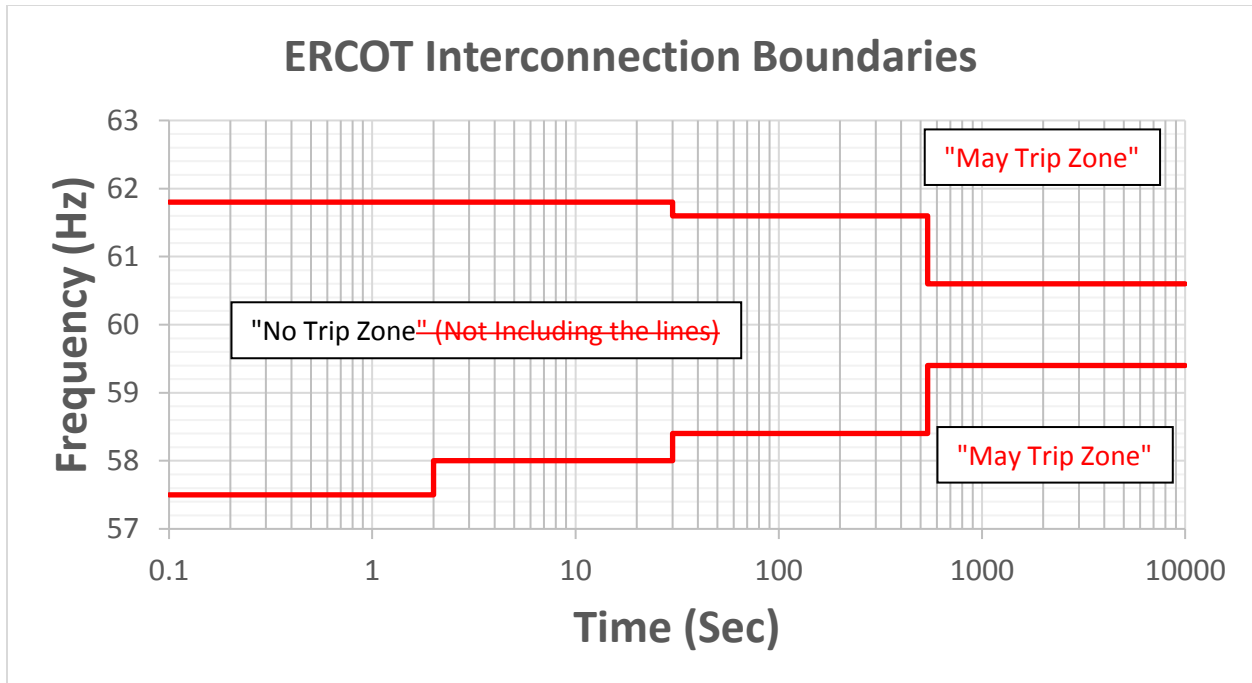

Figure 5

Curve Frequency -Boundary Data Points – ERCOT Interconnection

High Frequency Duration		Low Frequency Duration	
Frequency (Hz)	<u>Minimum</u> Time (Sec)	Frequency (Hz)	<u>Minimum</u> Time (sec)
≥61.8	<u>0.10</u> Instantaneous trip	≤57.5	<u>0.10</u> Instantaneous trip
≥61.6	30	≤58.0	2
≥60.6	540	≤58.4	30
<60.6	Continuous operation	≤59.4	540
		>59.4	Continuous operation

Table 3

PRC-024— Attachment 2

(Voltage No-Trip Boundary – Eastern, Western, and ERCOT Interconnections)

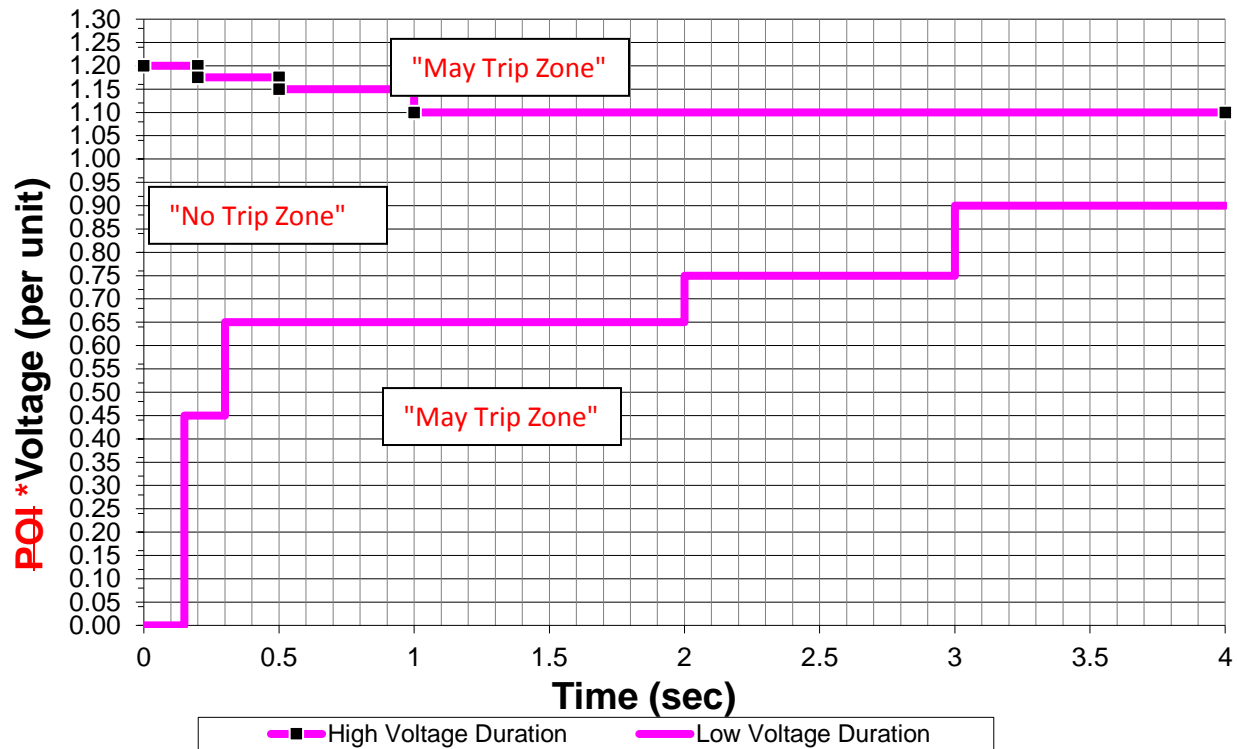

6

Figure 1

Voltage Boundary Data Points Ride Through Duration:

High Voltage Ride-Through Duration		Low Voltage Ride-Through Duration	
Voltage (pu)	<u>Minimum</u> Time (sec)	Voltage (pu)	<u>Minimum</u> Time (sec)
≥1.200	Instantaneous trip 0.00	<0.45	0.15
≥1.175	0.20	<0.65	0.30
≥1.15	0.50	<0.75	2.00
≥1.10	1.00	<0.90	3.00

*Voltage at the high-side of the GSU or collector transformer.

<u><1.10</u>	<u>4.00</u>	<u>≥ 0.90</u>	<u>4.00</u>
-----------------	-------------	---------------	-------------

Table 1

Voltage at the high-side of the GSU or collector transformer.

Voltage Boundary Clarifications – Eastern, Western, and ERCOT Interconnections

Boundary Details:

1. The per unit voltage base for these ~~boundaries~~~~curves~~ is the nominal operating voltage (e.g., 115 kV, 138 kV, 230 kV, 345 kV, 500 kV, etc.) ~~specified by the Transmission Planner in the analysis of the reliability of the Interconnected Transmission Systems at the point of interconnection to the Bulk Electric System (BES).~~
2. ~~The curves depicted were derived based on three-phase transmission system zone 1 faults with Normal Clearing not exceeding 9 cycles.~~ The boundaries apply to voltage excursions regardless of the type of initiating event.
3. The ~~values in the table represent the minimum time durations allowed for specified voltage excursion thresholds.~~ ~~envelope within the curves represents the cumulative voltage duration at the point of interconnection with the BES.~~ For example, if the voltage first exceeds 1.15 pu at 0.3 seconds after a fault, does not exceed 1.2 pu voltage, and returns below 1.15 pu at 0.4 seconds, then ~~the cumulative time the voltage is above 1.15 pu voltage is 0.1 seconds and is within the no trip zone of the curve.~~
4. The ~~boundaries~~ ~~curves~~ depicted assume a system frequency is of 60 Hertz. When evaluating ~~volts per hertz~~ Volts/Hertz protection, ~~you may adjust the~~ magnitude of the high voltage ~~curve~~ ~~boundary can be adjusted~~ in proportion to deviations of frequency below 60 Hertz.
5. Voltages in the ~~curve~~ ~~boundaries~~ assume RMS minimum fundamental frequency phase-to-ground or phase-to-phase voltage, ~~for the low voltage duration curve and the greater of maximum RMS or crest phase-to-phase voltage for the high voltage duration curve~~
- 5-6. ~~The “no trip zone” ends at 4 seconds.~~

Evaluating ~~Protection~~ Protective Relay Settings:

1. Use either the following assumptions or loading conditions that are believed to be the most probable for the unit under study to evaluate voltage protection ~~relay~~ setting calculations on the static case for steady state initial conditions:
 - a. All of the units connected to the same transformer are online and operating.
 - b. All of the units are at full nameplate real-power output.
 - c. Power factor is 0.95 lagging (i.e. supplying reactive power to the system) as measured at the generator terminals.
 - d. The automatic voltage regulator is in automatic voltage control mode.
2. ~~Evaluate voltage protection~~ ~~relay~~ settings assuming that additional installed generating plant reactive support equipment (such as static VAR compensators, synchronous condensers, or capacitors) is available and operating normally.
3. ~~Evaluate voltage protection~~ ~~relay~~ settings accounting for the actual tap settings of transformers between the generator terminals and the ~~point of interconnection~~ high

side of the GSU or collection transformer.

PRC-024— Attachment 2a (Voltage No Trip Boundaries – Quebec Interconnection)

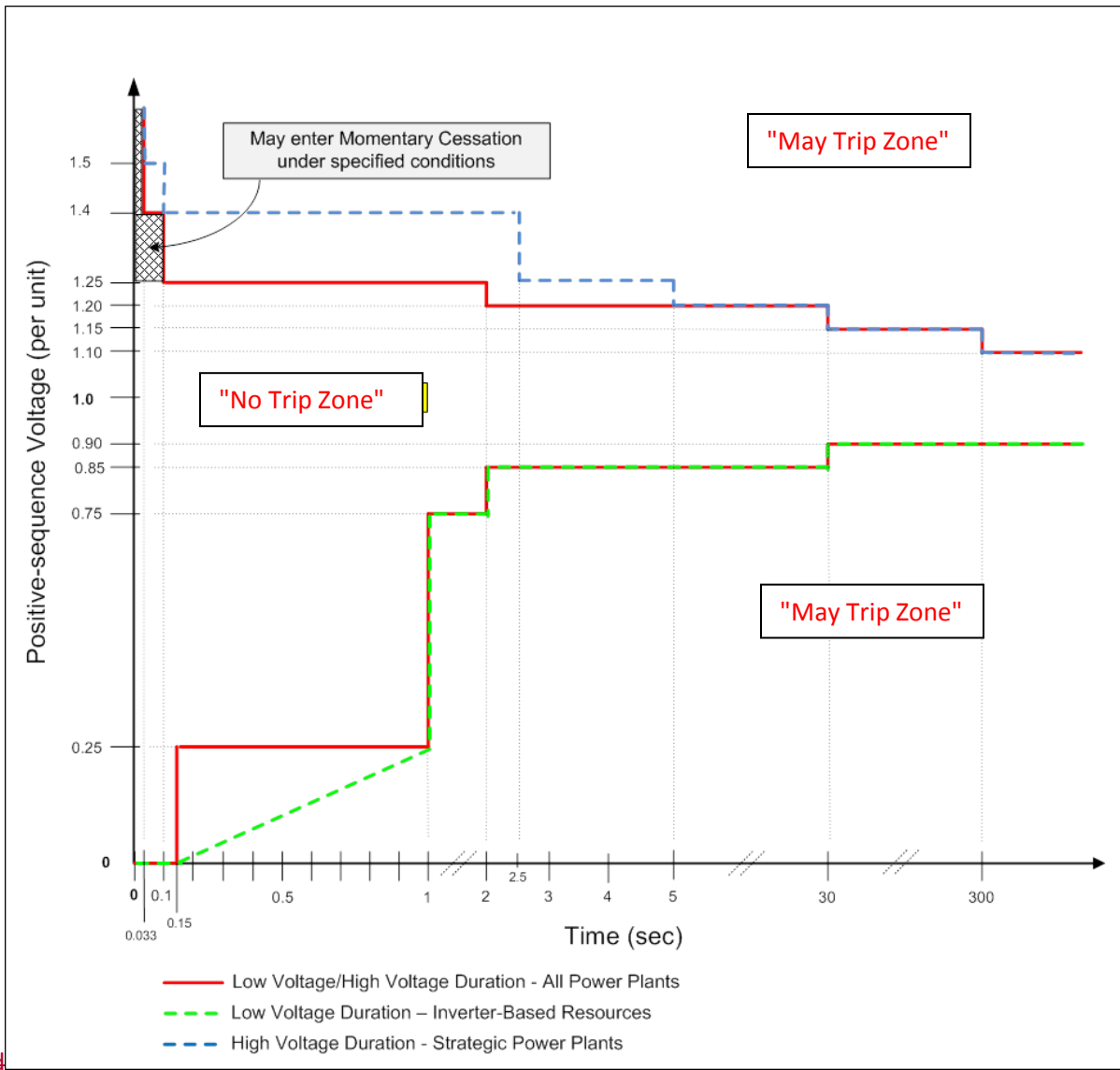

Figure 1a

Voltage Boundary Data Points – Quebec Interconnection

<u>High Voltage Duration for all Power Plants</u>		<u>High Voltage Duration for strategic¹ Power Plants</u>	
<u>Voltage (pu)</u>	<u>Minimum Time (sec)</u>	<u>Voltage (pu)</u>	<u>Minimum Time (sec)</u>
<u>---</u>	<u>---</u>	<u>>1.50</u>	<u>0.033</u>
<u>>1.40</u>	<u>0.033</u>	<u>>1.40</u>	<u>0.10</u>
<u>>1.25</u>	<u>0.10</u>	<u>>1.25</u>	<u>2.50</u>
<u>>1.20</u>	<u>2.00</u>	<u>>1.20</u>	<u>5.00</u>
<u>>1.15</u>	<u>30</u>	<u>>1.15</u>	<u>30</u>
<u>>1.10</u>	<u>300</u>	<u>>1.10</u>	<u>300</u>
<u>≤1.10</u>	<u>continuous</u>	<u>≤1.10</u>	<u>continuous</u>

Table 1a

Voltage Boundary Data Points – Quebec Interconnection

<u>Low Voltage Duration for all Power Plants</u>		<u>Low Voltage Duration for Inverter-Based Resources</u>	
<u>Voltage (pu)</u>	<u>Minimum Time (sec)</u>	<u>Voltage (pu)</u>	<u>Minimum Time (sec)</u>
<u><0.25</u>	<u>0.15</u>	<u><0.25</u>	<u>3.4*V(pu)+0.15</u>
<u><0.75</u>	<u>1.00</u>	<u><0.75</u>	<u>1.00</u>
<u><0.85</u>	<u>2.00</u>	<u><0.85</u>	<u>2.00</u>
<u><0.90</u>	<u>30</u>	<u><0.90</u>	<u>30</u>
<u>≥0.90</u>	<u>continuous</u>	<u>≥0.90</u>	<u>continuous</u>

Table 2a

¹ Power Plants designated by the Transmission Planner for protecting the integrity of Transmission System equipment.

Voltage Boundary Clarifications – Quebec Interconnection

Boundary Details:

1. The per unit voltage base for these boundaries is the nominal operating voltage (e.g., 115 kV, 138 kV, 230 kV, 345 kV, 500 kV, etc.).
2. The boundaries apply to voltage excursions regardless of the type of initiating event.
3. The values in the table represent the minimum time durations allowed for specified voltage excursion thresholds.
4. The boundaries assume a system frequency of 60 Hertz. When evaluating volts per hertz protection, magnitude of the high voltage boundary can be adjusted in proportion to deviations of frequency below 60 Hertz.
5. Voltages in the boundaries assume positive-sequence values.

Evaluating Protection Settings:

1. Use either the following assumptions or loading conditions that are believed to be the most probable for the unit under study to evaluate voltage protection setting calculations on the static case for steady state initial conditions:
 - a. All of the units connected to the same transformer are online and operating.
 - b. All of the units are at full nameplate real-power output.
 - c. Power factor is 0.95 lagging (i.e. supplying reactive power to the system) as measured at the generator terminals.
 - d. The automatic voltage regulator is in automatic voltage control mode.
2. Evaluate voltage protection settings assuming that additional installed generating plant reactive support equipment (such as static VAr compensators, synchronous condensers, or capacitors) is available and operating normally.
3. Evaluate voltage protection settings accounting for the actual tap settings of transformers between the generator terminals and the high side of the GSU or collector transformer.

Implementation Plan

Project 2018-04 Modifications to PRC-024-2 Reliability Standard PRC-024-3

Applicable Standard

- Reliability Standard PRC-024-3 – Generator Frequency and Voltage Protection Settings

Requested Retirement

- Reliability Standard PRC-024-2 – Generator Frequency and Voltage Protective Relay Settings

Prerequisite Standard(s)

- None

Applicable Entities

- Generator Owners that apply protection listed in Section 4.2.1.
- Transmission Owners that own a BES generator step-up transformer or collector transformer and apply protection listed in Section 4.2.1.

Background

On November 27, 2018, the NERC Operating Committee (OC) and Planning Committee (PC) submitted a Standard Authorization Request (SAR) prepared by the Inverter-Based Resource Performance Task Force (IRPTF), which reports to the OC and PC. Project 2018-04 addresses this SAR.

In 2017, the OC and PC convened the IRPTF shortly after it became clear that inverter-based generation was dropping off-line during normally cleared Bulk Power System (BPS) line faults. The NERC IRPTF supported NERC and WECC staff in the analysis of the [Blue Cut Fire](#) and [Canyon 2 Fire](#) disturbances in southern California. From the key findings and recommendations in the reports on the analysis, the IRPTF (as a stakeholder group of industry experts) developed recommended performance characteristics from inverter-based resources connected to the BPS.

Based off the disturbance analyses and development of the [PRC-024-2 Gaps Whitepaper](#), the IRPTF identified potential modifications to PRC-024-2 to help ensure that inverter-based generator owners, operators, developers, and equipment manufacturers understand the intent of the standard in order for their plants respond to grid disturbances in a manner that contributes to the reliable operation of the BPS.

General Considerations

This Implementation Plan includes an effective date as well as phased-in compliance dates. As detailed below, there are two compliance dates: one for Generator Owners and one for Transmission Owners.

Effective Date

Reliability Standard PRC-024-3

Where approval by an applicable governmental authority is required, the standard shall become effective on the first day of the first calendar quarter that is eighteen (18) months after the effective date of the applicable governmental authority's order approving the standard, or as otherwise provided for by the applicable governmental authority.

Where approval by an applicable governmental authority is not required, the standard shall become effective on the first day of the first calendar quarter that is eighteen (18) months after the date the standard is adopted by the NERC Board of Trustees, or as otherwise provided for in that jurisdiction.

Compliance Date for Applicable Generator Owners

Applicable Generator Owners shall comply with all Requirements upon the effective date of Reliability Standard PRC-024-3.

Compliance Date for Applicable Transmission Owners

Applicable Transmission Owners shall not be required to comply with the Requirements until forty-two (42) months after the effective date of Reliability Standard PRC-024-3.

Retirement Date

Reliability Standard PRC-024-2

Reliability Standard PRC-024-2 shall be retired immediately prior to the effective date of Reliability Standard PRC-024-3 in the particular jurisdiction in which the revised standard is becoming effective.

Unofficial Comment Form

Project 2018-04 Modifications to PRC-024-2

Do not use this form for submitting comments. Use the [Standards Balloting and Commenting System \(SBS\)](#) to submit comments on **PRC-024-3 – Generator Voltage and Frequency Protection**. Comments must be submitted by **8 p.m. Eastern, Friday, May 31, 2019**.

Additional information is available on the [project page](#). If you have questions, contact Standards Developer, [Mat Bunch](#) (via email), or at (404) 446-9785.

Background Information

On November 27, 2018, the NERC Operating Committee (OC) and Planning Committee (PC) submitted a Standard Authorization Request (SAR) prepared by the Inverter-Based Resource Performance Task Force (IRPTF), which reports to the OC and PC.

Based off the analyses of the [Blue Cut Fire](#) and [Canyon 2 Fire](#) disturbances in southern California along with the development of the [PRC-024-2 Gaps Whitepaper](#), the IRPTF identified potential modifications to PRC-024-2 to ensure that inverter-based generator owners, operators, developers, and equipment manufacturers understand the intent of the standard in order for their plants to respond to grid disturbances in a manner that contributes to the reliable operation of the BPS. In order to address the issues in the [SAR](#), the standard drafting team developed the proposed modifications in PRC-024-3.

PRC-024-3 – Summary of Key Changes

Momentary Cessation

- Requirements R1 and R2 modified to specify a generating resource may neither trip NOR enter momentary cessation inside the No Trip Zone

No Trip Zone

- To clarify confusion regarding tripping or entering momentary cessation *outside* the No Trip Zone, the area outside the boundary is now labeled as a “May Trip Zone”

Applicability Section

- Facilities Section added that explicitly lists protective functions for specific equipment
 - Plant Auxiliary Equipment is not included as an applicable facility
 - Specifies that voltage and frequency protection should be applied to both generator step-up (GSU) and collector transformers
 - Addresses a potential reliability gap identified by the standard drafting team

- Some Transmission Owners (TOs) own GSU or collector transformers, yet not currently in the scope PRC-024

Inclusion of Some TOs as Functional Entities¹

- *Not all TOs are applicable*
- Only those specific TOs that own a GSU or collector transformer and apply protection listed in the facilities section are now in scope of PRC-024

Point of Interconnection (POI)

- To address ambiguity concerns, removed the term altogether and replaced with precise language for this standard:
 - “at the high side of the GSU or collector transformer”

Figures and Tables

- Clarified areas of confusion as specified by the Standard Authorization Request
- General “clean up” work throughout

Variance – Quebec Interconnection

- Variance to Requirement R2 with more stringent under/over voltage boundaries

¹ Requirements R1 and R2 in the currently enforceable PRC-024-2 standard, via footnotes 2 and 4, include all frequency and voltage protective relays from the individual generating resource to the high side of the main power transformer for dispersed power producing resources. There was also an identified potential reliability gap when frequency and voltage protection, specifically volts per hertz, are applied to conventional generator GSUs. To alleviate this potential reliability gap, and to achieve parity for all resources, the SDT added a facilities section to specify the facilities that are subject to the Standard, if those facilities have frequency and voltage protection enabled. The facilities section now clarifies that the GSU or collector transformer is an applicable facility.

Questions

1. The standards drafting team (SDT) replaced “protective relays” to “protection” throughout the standard to include relays, settings in applicable control systems, as well as other types of voltage and frequency protection devices. Do you agree with these modifications? If you do not agree, or if you agree but have comments or suggestions, provide your recommendation, explanation, and proposed modification.

- Yes
 No

Comments:

2. To address confusion regarding “at the point of interconnection,” the team replaced it with the phrase, “at the high side of the generator step-up or collector transformer.” Do you agree with this clarifying change? If not, please provide an alternative suggestion.

- Yes
 No

Comments:

3. The SDT modified Requirements R1 and R2 to not allow momentary cessation, in addition to tripping, in the “no trip zone.” Do you agree that momentary cessation should not be allowed in the no trip zone? If not, please provide your rationale.

- Yes
 No

Comments:

4. Do you agree that “momentary cessation” – like “tripping” – is well understood by industry? If not, please provide your rationale.

- Yes
 No

Comments:

5. The SDT was apprised that, in some instances, the TO may own the GSU or collector transformers. As such, TOs were added to the applicable entity for cases where they may own a GSU or collector transformers with frequency and voltage protection enabled. Do you agree with the addition of

TOs who own a GSU or collector transformer to the applicable entities? If not, please provide your rationale.

- Yes
 No

Comments:

6. Another intent of the facilities section was to clarify that voltage and frequency protection applied to plant auxiliary equipment is not applicable to the standard. Do you agree it is clear that plant aux equipment is out of scope of PRC-024? If not, please provide your rationale and a proposal.

- Yes
 No

Comments:

7. The SDT made several clarifying changes to the figures and tables (outlined in the SAR) to improve readability and eliminate confusion addressed in the SAR, including: (i) labeling the area outside the “No Trip Zone” as the “May Trip Zone;” (ii) removal of “ride-through” language; (iii) addition of “Minimum Time;” (iv) replacement of “instantaneous” with “0.10” seconds; and (v) clarifying modifications to the Voltage Boundary Clarifications. Do you agree with these modifications? If not, please recommend alternative solution(s).

- Yes
 No

Comments:

8. The SDT added Quebec Interconnection-wide Variance to Requirement R2 with more stringent voltage boundaries for the No Trip Zone. Do you agree with this proposed Quebec Variance? If not, please provide your rationale.

- Yes
 No

Comments:

9. Do you agree with the proposed Implementation Plan? If not, please provide your rationale.

- Yes
 No

Comments:

10. Do you agree that the proposed modifications provide a cost-effective means of addressing issues in the SAR? If not, please provide an alternative, more cost-effective manner in which to achieve at least an equivalent level of reliability.

Yes

No

Comments:

11. If you have any additional comments on themes that have NOT already been addressed in the proceeding questions on this comment form, please provide them here.

Comments:

Violation Risk Factor and Violation Severity Level Justification

Project 2018-04 Modifications to PRC-024-2 April 2019

This document provides the standard drafting team's (SDT's) justification for assignment of violation risk factors (VRFs) and violation severity levels (VSLs) for each requirement in Reliability Standard PRC-024-3. Each requirement is assigned a VRF and a VSL. These elements support the determination of an initial value range for the Base Penalty Amount regarding violations of requirements in FERC-approved Reliability Standards, as defined in the Electric Reliability Organizations (ERO) Sanction Guidelines. The SDT applied the following NERC criteria and FERC Guidelines when developing the VRFs and VSLs for the requirements.

NERC Criteria for Violation Risk Factors

High Risk Requirement

A requirement that, if violated, could directly cause or contribute to Bulk Electric System instability, separation, or a cascading sequence of failures, or could place the Bulk Electric System at an unacceptable risk of instability, separation, or cascading failures; or, a requirement in a planning time frame that, if violated, could, under emergency, abnormal, or restorative conditions anticipated by the preparations, directly cause or contribute to Bulk Electric System instability, separation, or a cascading sequence of failures, or could place the Bulk Electric System at an unacceptable risk of instability, separation, or cascading failures, or could hinder restoration to a normal condition.

Medium Risk Requirement

A requirement that, if violated, could directly affect the electrical state or the capability of the Bulk Electric System, or the ability to effectively monitor and control the Bulk Electric System. However, violation of a medium risk requirement is unlikely to lead to Bulk Electric System instability, separation, or cascading failures; or, a requirement in a planning time frame that, if violated, could, under emergency, abnormal, or restorative conditions anticipated by the preparations, directly and adversely affect the electrical state or capability of the Bulk Electric System, or the ability to effectively monitor, control, or restore the Bulk Electric System. However, violation of a medium risk requirement is unlikely, under emergency, abnormal, or restoration conditions anticipated by the preparations, to lead to Bulk Electric System instability, separation, or cascading failures, nor to hinder restoration to a normal condition.

Lower Risk Requirement

A requirement that is administrative in nature and a requirement that, if violated, would not be expected to adversely affect the electrical state or capability of the Bulk Electric System, or the ability to effectively monitor and control the Bulk Electric System; or, a requirement that is administrative in nature and a requirement in a planning time frame that, if violated, would not, under the emergency, abnormal, or restorative conditions anticipated by the preparations, be expected to adversely affect the electrical state or capability of the Bulk Electric System, or the ability to effectively monitor, control, or restore the Bulk Electric System.

FERC Guidelines for Violation Risk Factors

Guideline (1) – Consistency with the Conclusions of the Final Blackout Report

FERC seeks to ensure that VRFs assigned to Requirements of Reliability Standards in these identified areas appropriately reflect their historical critical impact on the reliability of the Bulk-Power System. In the VSL Order, FERC listed critical areas (from the Final Blackout Report) where violations could severely affect the reliability of the Bulk-Power System:

- Emergency operations
- Vegetation management
- Operator personnel training
- Protection systems and their coordination
- Operating tools and backup facilities
- Reactive power and voltage control
- System modeling and data exchange
- Communication protocol and facilities
- Requirements to determine equipment ratings
- Synchronized data recorders
- Clearer criteria for operationally critical facilities
- Appropriate use of transmission loading relief.

Guideline (2) – Consistency within a Reliability Standard

FERC expects a rational connection between the sub-Requirement VRF assignments and the main Requirement VRF assignment.

Guideline (3) – Consistency among Reliability Standards

FERC expects the assignment of VRFs corresponding to Requirements that address similar reliability goals in different Reliability Standards would be treated comparably.

Guideline (4) – Consistency with NERC’s Definition of the Violation Risk Factor Level

Guideline (4) was developed to evaluate whether the assignment of a particular VRF level conforms to NERC’s definition of that risk level.

Guideline (5) – Treatment of Requirements that Co-mingle More Than One Obligation

Where a single Requirement co-mingles a higher risk reliability objective and a lesser risk reliability objective, the VRF assignment for such Requirements must not be watered down to reflect the lower risk level associated with the less important objective of the Reliability Standard.

NERC Criteria for Violation Severity Levels

VSLs define the degree to which compliance with a requirement was not achieved. Each requirement must have at least one VSL. While it is preferable to have four VSLs for each requirement, some requirements do not have multiple “degrees” of noncompliant performance and may have only one, two, or three VSLs.

VSLs should be based on NERC’s overarching criteria shown in the table below:

Lower VSL	Moderate VSL	High VSL	Severe VSL
The performance or product measured almost meets the full intent of the requirement.	The performance or product measured meets the majority of the intent of the requirement.	The performance or product measured does not meet the majority of the intent of the requirement, but does meet some of the intent.	The performance or product measured does not substantively meet the intent of the requirement.

FERC Order of Violation Severity Levels

The FERC VSL guidelines are presented below, followed by an analysis of whether the VSLs proposed for each requirement in the standard meet the FERC Guidelines for assessing VSLs:

Guideline (1) – Violation Severity Level Assignments Should Not Have the Unintended Consequence of Lowering the Current Level of Compliance

Compare the VSLs to any prior levels of non-compliance and avoid significant changes that may encourage a lower level of compliance than was required when levels of non-compliance were used.

Guideline (2) – Violation Severity Level Assignments Should Ensure Uniformity and Consistency in the Determination of Penalties

A violation of a “binary” type requirement must be a “Severe” VSL.

Do not use ambiguous terms such as “minor” and “significant” to describe noncompliant performance.

Guideline (3) – Violation Severity Level Assignment Should Be Consistent with the Corresponding Requirement

VSLs should not expand on what is required in the requirement.

Guideline (4) – Violation Severity Level Assignment Should Be Based on A Single Violation, Not on A Cumulative Number of Violations

Unless otherwise stated in the requirement, each instance of non-compliance with a requirement is a separate violation. Section 4 of the Sanction Guidelines states that assessing penalties on a per violation per day basis is the “default” for penalty calculations.

Justification for PRC-024-3 VRFs and VSLs

VRF Justification for PRC-024-3, Requirement R1

The VRF did not change from the previously FERC-approved PRC-024-2 Reliability Standard.

VSL Justification for PRC-024-3, Requirement R1

The SDT only made changes to conform the Requirement R1 VSL to the revised Requirement R1 language. The SDT retained the binary structure of the VSL, which is consistent with both the PRC-024-2 and PRC-024-1 VSLs. As a result, the [justification](#) for the Commission-approved PRC-024-1 Requirement R1 VSL supports the justification for the proposed PRC-024-3, Requirement R1 VSL.

VRF Justification for PRC-024-3, Requirement R2

The VRF did not change from the previously FERC-approved PRC-024-2 Reliability Standard.

VSL Justification for PRC-024-3, Requirement R2

The SDT only made changes to conform the Requirement R2 VSL to the revised Requirement R2 language. The SDT retained the binary structure of the VSL, which is consistent with both the PRC-024-2 and PRC-024-1 VSLs. As a result, the [justification](#) for the Commission-approved PRC-024-1 Requirement R2 VSL supports the justification for the proposed PRC-024-3, Requirement R2 VSL.

VRF Justification for PRC-024-3, Requirement R3

The VRF did not change from the previously FERC-approved PRC-024-2 Reliability Standard.

VSL Justification for PRC-024-3, Requirement R3

The SDT only revised the Requirement R3 VSL to add Transmission Owner. The SDT retained the existing levels of the VSLs, which is consistent with both the PRC-024-2 and PRC-024-1 VSLs. As a result, the [justification](#) for the Commission-approved PRC-024-1 Requirement R3 VSL supports the justification for the proposed PRC-024-3, Requirement R3 VSL.

VRF Justification for PRC-024-3, Requirement R4

The VRF did not change from the previously FERC-approved PRC-024-2 Reliability Standard.

VSL Justification for PRC-024-3, Requirement R4

The SDT only revised the Requirement R4 VSL to add Transmission Owner. The SDT retained the existing levels of the VSLs, which is consistent with both the PRC-024-2 and PRC-024-1 VSLs. As a result, the [justification](#) for the Commission-approved PRC-024-1 Requirement R4 VSL supports the justification for the proposed PRC-024-3, Requirement R4 VSL.

PRC-024-3 – Summary of Key Changes

Project 2018-04 Modifications to PRC-024-2

Momentary Cessation

- Requirements R1 and R2 modified to specify that a generating resource may neither trip NOR enter momentary cessation inside the No Trip Zone

No Trip Zone

- To clarify confusion regarding tripping or entering momentary cessation *outside* the No Trip Zone, the area outside the boundary is now labeled as a “May Trip Zone”

Applicability Section

- Facilities Section added that explicitly lists protective functions for specific equipment
 - Plant Auxiliary Equipment is not included as an applicable facility
 - Specifies that voltage and frequency protection should be applied to both generator step-up (GSU) and collector transformers
 - Addresses a potential reliability gap identified by the standard drafting team
 - Some Transmission Owners (TOs) own GSU or collector transformers, yet are not currently in scope PRC-024

Inclusion of Some TOs as Functional Entities¹

- *Not all TOs are applicable*
- Only those specific TOs that own a GSU or collector transformer and apply protection listed in the facilities section are now in scope of PRC-024

Point of Interconnection (POI)

- To address ambiguity concerns, removed the term altogether and replaced with precise language for this standard:

¹ Requirements R1 and R2 in the currently enforceable PRC-024-2 standard, via footnotes 2 and 4, include all frequency and voltage protective relays from the individual generating resource to the high side of the main power transformer for dispersed power producing resources. There was also an identified potential reliability gap when frequency and voltage protection, specifically volts per hertz, are applied to conventional generator GSUs. To alleviate this potential reliability gap, and to achieve parity for all resources, the SDT added a facilities section to specify the facilities that are subject to the Standard, if those facilities have frequency and voltage protection enabled. The facilities section now clarifies that the GSU or collector transformer is an applicable facility.

- “at the high side of the GSU or collector transformer”

Figures and Tables

- Clarified areas of confusion as specified by the Standard Authorization Request
- General “clean up” work throughout

Variance – Quebec Interconnection

- Variance to Requirement R2 with more stringent under/over voltage boundaries

DRAFT Reliability Standard Audit Worksheet¹

PRC-024-3 – Generator Frequency and Voltage Protection Settings

This section to be completed by the Compliance Enforcement Authority.

Audit ID: Audit ID if available; or REG-NCRnnnnn-YYYYMMDD
Registered Entity: Registered name of entity being audited
NCR Number: NCRnnnnn
Compliance Enforcement Authority: Region or NERC performing audit
Compliance Assessment Date(s)²: Month DD, YYYY, to Month DD, YYYY
Compliance Monitoring Method: [On-site Audit | Off-site Audit | Spot Check]
Names of Auditors: Supplied by CEA

Applicability of Requirements³

	BA	DP	GO	GOP	IA	LSE	PA	PSE	RC	RP	RSG	TO	TOP	TP	TSP
R1			X									X			
R2			X									X			
R3			X									X			
R4			X									X			

Legend:

Text with blue background:	Fixed text – do not edit
Text entry area with Green background:	Entity-supplied information
Text entry area with white background:	Auditor-supplied information

¹ NERC developed this Reliability Standard Audit Worksheet (RSAW) language in order to facilitate NERC’s and the Regional Entities’ assessment of a registered entity’s compliance with this Reliability Standard. The NERC RSAW language is written to specific versions of each NERC Reliability Standard. Entities using this RSAW should choose the version of the RSAW applicable to the Reliability Standard being assessed. While the information included in this RSAW provides some of the methodology that NERC has elected to use to assess compliance with the requirements of the Reliability Standard, this document should not be treated as a substitute for the Reliability Standard or viewed as additional Reliability Standard requirements. In all cases, the Regional Entity should rely on the language contained in the Reliability Standard itself, and not on the language contained in this RSAW, to determine compliance with the Reliability Standard. NERC’s Reliability Standards can be found on NERC’s website. Additionally, NERC Reliability Standards are updated frequently, and this RSAW may not necessarily be updated with the same frequency. Therefore, it is imperative that entities treat this RSAW as a reference document only, and not as a substitute or replacement for the Reliability Standard. It is the responsibility of the registered entity to verify its compliance with the latest approved version of the Reliability Standards, by the applicable governmental authority, relevant to its registration status.

The RSAW may provide a non-exclusive list, for informational purposes only, of examples of the types of evidence a registered entity may produce or may be asked to produce to demonstrate compliance with the Reliability Standard. A registered entity’s adherence to the examples contained within this RSAW does not necessarily constitute compliance with the applicable Reliability Standard, and NERC and the Regional Entity using this RSAW reserve the right to request additional evidence from the registered entity that is not included in this RSAW. This RSAW may include excerpts from FERC Orders and other regulatory references which are provided for ease of reference only, and this document does not necessarily include all applicable Order provisions. In the event of a discrepancy between FERC Orders, and the language included in this document, FERC Orders shall prevail.

² Compliance Assessment Date(s): The date(s) the actual compliance assessment (on-site audit, off-site spot check, etc.) occurs.

³ Refer to PRC-024-3 Section 4, Applicability, to determine which GOs and TOs are subject to PRC-024-3.

DRAFT NERC Reliability Standard Audit Worksheet

Findings

(This section to be completed by the Compliance Enforcement Authority)

Req.	Finding	Summary and Documentation	Functions Monitored
R1			
R2			
R3			
R4			

Req.	Areas of Concern

Req.	Recommendations

Req.	Positive Observations

DRAFT NERC Reliability Standard Audit Worksheet

Subject Matter Experts

Identify the Subject Matter Expert(s) responsible for this Reliability Standard.

Registered Entity Response (Required; Insert additional rows if needed):

SME Name	Title	Organization	Requirement(s)

DRAFT

R1 Supporting Evidence and Documentation

- R1.** Each Generator Owner or Transmission Owner shall set its applicable frequency protection such that the generating resource does not trip or enter momentary cessation within the “no trip zone” of PRC-024 Attachment 1, subject to the following exception:
- Generating resource(s) may be set to trip or enter momentary cessation within a portion of the “no trip zone” of PRC-024 Attachment 1 for documented and communicated regulatory or equipment limitations in accordance with Requirement R3.
- M1.** Each Generator Owner or Transmission Owner shall have evidence that the applicable frequency protection has been set in accordance with Requirement R1 such as dated setting sheets, calibration sheets, calculations, or other documentation.

Registered Entity Response (Required):

Question: Does your entity own any applicable frequency protection set to trip or enter momentary cessation in accordance with Requirement R1? Yes No

If yes, provide a summary of the applicable frequency protection in the box below, and proceed to the Registered Entity Response section below.

[Note: A separate spreadsheet or other document may be used. If so, provide the document reference below.]

Registered Entity Response (Required):

Compliance Narrative:

Provide a brief explanation, in your own words, of how you comply with this Requirement. References to supplied evidence, including links to the appropriate page, are recommended.

Evidence Requested¹:

Provide the following evidence, or other evidence to demonstrate compliance.
A list of all applicable frequency protection that is set to trip or enter momentary cessation for applicable generating resources(s).
A list of applicable frequency protection that has exceptions, as listed in Requirement R1, including the reason for each exception.
For all, or a sample of applicable frequency protection selected by the auditor, dated setting sheets, calibration sheets, calculations, or other documentation that demonstrate that applicable frequency protection settings were set such that the applicable frequency protection does not trip or enter momentary cessation for the applicable generating resource(s) within the “no trip zone” of PRC-024 Attachment 1.

Registered Entity Evidence (Required):

DRAFT NERC Reliability Standard Audit Worksheet

The following information is requested for each document submitted as evidence. Also, evidence submitted should be highlighted and bookmarked, as appropriate, to identify the exact location where evidence of compliance may be found.

File Name	Document Title	Revision or Version	Document Date	Relevant Page(s) or Section(s)	Description of Applicability of Document

Audit Team Evidence Reviewed (This section to be completed by the Compliance Enforcement Authority):

Compliance Assessment Approach Specific to PRC-024-3, R1

This section to be completed by the Compliance Enforcement Authority

	Select all, or a sample thereof, applicable frequency protection and verify the settings are set to prevent the applicable generating resources from tripping or entering momentary cessation within the “no trip zone” of PRC-024-3 Attachment 1 (unless the specified exception applies).

Notes to Auditor:

Section 4 of the Standard, Applicability, guides the applicable protection to which this requirement pertains. Applicable frequency protection must be set within high and low frequency limits, and frequency duration limits per PRC-024 Attachment 1. Furthermore, the auditor needs to ensure the compliance assessment is performed with the appropriate Interconnection curve.

Auditor Notes:

--

R2 Supporting Evidence and Documentation

- R2.** Each Generator Owner or Transmission Owner shall set its applicable voltage protection such that the generating resource does not trip or enter momentary cessation within the “no trip zone” of PRC-024 Attachment 2 during a voltage excursion at the high side of the GSU or collector transformer, subject to the following exceptions:
- If the Transmission Planner allows less stringent voltage protection settings than those required to meet PRC-024 Attachment 2, then the Generator Owner or Transmission Owner may set its protection within the voltage recovery characteristics of a location-specific Transmission Planner’s study.
 - Generating resource(s) may trip or enter momentary cessation within a portion of the “no trip zone” of PRC-024 Attachment 2 for documented and communicated regulatory or equipment limitations in accordance with Requirement R3.
- M2.** Each Generator Owner or Transmission Owner shall have evidence that applicable voltage protection has been set in accordance with Requirement R2, such as dated setting sheets, voltage-time curves, calibration sheets, coordination plots, dynamic simulation studies, calculations, or other documentation.

Registered Entity Response (Required):

Question: Does your entity own any applicable voltage protection set to trip or enter momentary cessation in accordance with Requirement R2? Yes No

If yes, provide a summary of the applicable voltage protection in the box below, and proceed to the Registered Entity Response section below.

[Note: A separate spreadsheet or other document may be used. If so, provide the document reference below.]

Evidence Requested:

Provide the following evidence, or other evidence to demonstrate compliance.
A list of all applicable voltage protection that is set to trip or enter momentary cessation for applicable generating resources(s).
A list of applicable voltage protection that has exceptions, as listed in Requirement R2, including the reason for each exception.
For all, or a sample of applicable voltage protection selected by the auditor, dated setting sheets, voltage-time curves, calibration sheets, coordination plots, dynamic simulation studies, calculations, or other documentation that demonstrates that applicable voltage protection were set such that the applicable voltage protection does not trip or enter momentary cessation for the applicable generating resource(s) within the “no trip zone” of PRC-024 Attachment 2.
If the Transmission Planner allows less stringent voltage settings than those required to meet PRC-024 Attachment 2, then provide documentation of the less stringent settings including the Transmission Planner’s location-specific study.

DRAFT NERC Reliability Standard Audit Worksheet

Registered Entity Evidence (Required):

The following information is requested for each document submitted as evidence. Also, evidence submitted should be highlighted and bookmarked, as appropriate, to identify the exact location where evidence of compliance may be found.

File Name	Document Title	Revision or Version	Document Date	Relevant Page(s) or Section(s)	Description of Applicability of Document

Audit Team Evidence Reviewed (This section to be completed by the Compliance Enforcement Authority):

Compliance Assessment Approach Specific to PRC-024-3, R2

This section to be completed by the Compliance Enforcement Authority

	Select all, or a sample thereof, applicable voltage protection, and verify the settings are set to prevent the applicable generating resources from tripping or entering momentary cessation within the “no trip zone” of PRC-024-2 Attachment 2 (unless one of two specified exceptions applies).
--	--

Note to Auditor: Section 4 of the Standard, Applicability, guides the applicable protection to which this requirement pertains. Applicable voltage protection must be set within high and low voltage limits, and durations per PRC-024 Attachment 2. Reference the “Voltage Ride-Through Curve Clarifications” in Attachment 2.

Auditor Notes:

--

R3 Supporting Evidence and Documentation

R3. Each Generator Owner or Transmission Owner shall document each known regulatory or equipment limitation⁴ that prevents applicable generating resource(s) with generator frequency or voltage protection from meeting the protection setting criteria in Requirements R1 or R2, including (but not limited to) study results, experience from an actual event, or manufacturer’s advice.

3.1. The Generator Owner or Transmission Owner shall communicate the documented regulatory or equipment limitation, or the removal of a previously documented regulatory or equipment limitation, to its Planning Coordinator and Transmission Planner within 30 calendar days of any of the following:

- Identification of a regulatory or equipment limitation.
- Repair of the equipment causing the limitation that removes the limitation.
- Replacement of the equipment causing the limitation with equipment that removes the limitation.
- Creation or adjustment of an equipment limitation caused by consumption of the cumulative turbine life-time frequency excursion allowance.

M3. Each Generator Owner or Transmission Owner shall have evidence that it has documented and communicated any known regulatory or equipment limitations that resulted in an exception to Requirements R1 or R2 in accordance with Requirement R3, such as a dated email or letter that contains such documentation as study results, experience from an actual event, or manufacturer’s advice.

Registered Entity Response (Required):

Question: Did your entity have any known regulatory or equipment limitation that prevents applicable generating resource(s) with generator frequency or voltage protection from meeting the setting criteria in Requirements R1 or R2 in accordance with Requirement R3 during the audit period? Yes No

If yes, provide a summary of the known regulatory or equipment limitations in the box below, and proceed to the Registered Entity Response section below.

[Note: A separate spreadsheet or other document may be used. If so, provide the document reference below.]

Question: Did your entity have any removal of a previously documented regulatory or equipment limitation in accordance with Requirement R3 during the audit period? Yes No

If yes, provide a summary of the removal of the previously documented regulatory or equipment limitation(s) in the box below, and proceed to the Registered Entity Response section below.

⁴ Excludes limitations that are caused by the setting capability of the generator frequency and voltage protection itself but does not exclude limitations originating in the equipment that it protects.

DRAFT NERC Reliability Standard Audit Worksheet

[Note: A separate spreadsheet or other document may be used. If so, provide the document reference below.]

Registered Entity Response (Required):

Compliance Narrative:

Provide a brief explanation, in your own words, of how you comply with this Requirement. References to supplied evidence, including links to the appropriate page, are recommended.

Evidence Requested:

Provide the following evidence, or other evidence to demonstrate compliance.
Provide a list of each known regulatory or equipment limitation that prevents an applicable generating resource with generator frequency or voltage protection from meeting the setting criteria in Requirements R1 or R2 in accordance with Requirement R3.
Provide a list of the removal(s) of a previously documented regulatory or equipment limitation in accordance with Requirement R3.
For all, or a sample selected by the auditor, dated email or letter that documents the entity communicated any known regulatory or equipment limitations, and removals of a previously documented regulatory or equipment limitation, to its Planning Coordinator and Transmission Planner within 30 calendar days in accordance with Requirement R3.

Registered Entity Evidence (Required):

The following information is requested for each document submitted as evidence. Also, evidence submitted should be highlighted and bookmarked, as appropriate, to identify the exact location where evidence of compliance may be found.					
File Name	Document Title	Revision or Version	Document Date	Relevant Page(s) or Section(s)	Description of Applicability of Document

Audit Team Evidence Reviewed (This section to be completed by the Compliance Enforcement Authority):

Compliance Assessment Approach Specific to PRC-024-3, R3

This section to be completed by the Compliance Enforcement Authority

<input type="checkbox"/>	Select all, or a sample thereof, and verify the entity documented each known regulatory or equipment limitation that prevents an applicable generating resource with generator frequency or voltage
--------------------------	---

DRAFT NERC Reliability Standard Audit Worksheet

protection from meeting the setting criteria in Requirements R1 or R2 in accordance with Requirement R3, and the entity is meeting the Implementation Plan.
Select all, or a sample thereof, and verify the entity communicated the documented regulatory or equipment limitation, or the removal of a previously documented regulatory or equipment limitation, to its Planning Coordinator and Transmission Planner within 30 calendar days in accordance with Requirement R3 for any of the following: <ul style="list-style-type: none">• Identification of a regulatory or equipment limitation.• Repair of the equipment causing the limitation that removes the limitation.• Replacement of the equipment causing the limitation with equipment that removes the limitation.• Creation or adjustment of an equipment limitation caused by consumption of the cumulative turbine life-time frequency excursion allowance.

Note to Auditor: Reference footnote 1 (of the Standard, footnote 7 in the RSAW) which states: “Excludes limitations that are caused by the setting capability of the generator frequency and voltage protection itself but does not exclude limitations originating in the equipment that it protects.”

Auditor Notes:

--

R4 Supporting Evidence and Documentation

- R4.** Each Generator Owner or Transmission Owner shall provide its applicable generator protection settings associated with Requirements R1 and R2 to the Planning Coordinator or Transmission Planner that models the associated generating resource(s) within 60 calendar days of receipt of a written request for the data and within 60 calendar days of any change to those previously requested settings unless directed by the requesting Planning Coordinator or Transmission Planner that the reporting of protection setting changes is not required.

- M4.** Each Generator Owner or Transmission Owner shall have evidence that it communicated applicable generator protection settings in accordance with Requirement R4, such as dated e-mails, correspondence or other evidence and copies of any requests it has received for that information.

Registered Entity Response (Required):

Question: Did your entity receive a written request for the data (applicable generator protection settings associated with Requirements R1 and R2) from the Planning Coordinator or Transmission Planner that models the associated resource during the audit period? Yes No

If yes, provide a summary of the written requests in the box below, including the name of the Planning Coordinator and Transmission Planner, and proceed to the Registered Entity Response section below.

[Note: A separate spreadsheet or other document may be used. If so, provide the document reference below.]

Question (Required): Did your entity have any changes to those previously requested settings? Yes No

If yes, provide a summary of the previously requested settings, and whether your entity was directed by the requesting Planning Coordinator or Transmission Planner that the reporting of protection setting changes is not required, and proceed to the Registered Entity Response section below.

[Note: A separate spreadsheet or other document may be used. If so, provide the document reference below.]

Registered Entity Response (Required):

Compliance Narrative:

Provide a brief explanation, in your own words, of how you comply with this Requirement. References to supplied evidence, including links to the appropriate page, are recommended.

Evidence Requested:

Provide the following evidence, or other evidence to demonstrate compliance.

Provide a list of all applicable generator protection settings associated with Requirements R1 and R2 that are associated with any written requests for the data by the Planning Coordinator or Transmission Planner that

DRAFT NERC Reliability Standard Audit Worksheet

models the associated unit.

Provide a list of any change to those previously requested settings (unless directed by the requesting Planning Coordinator or Transmission Planner that the reporting of protection setting changes is not required).

For all, or a sample selected by the auditor, dated e-mails, correspondence or other evidence and copies of any requests, that show the entity communicated applicable protection settings/changes within 60 calendar days of the written request in accordance with R4.

Registered Entity Evidence (Required):

The following information is requested for each document submitted as evidence. Also, evidence submitted should be highlighted and bookmarked, as appropriate, to identify the exact location where evidence of compliance may be found.

File Name	Document Title	Revision or Version	Document Date	Relevant Page(s) or Section(s)	Description of Applicability of Document

Audit Team Evidence Reviewed (This section to be completed by the Compliance Enforcement Authority):

Compliance Assessment Approach Specific to PRC-024-3, R4

This section to be completed by the Compliance Enforcement Authority

	Select all, or a sample thereof, and verify the entity communicated applicable protection settings/changes (such as dated e-mails, correspondence or other evidence, and copies of any requests) within 60 calendar days of the written request/change in accordance with R4.
Note to Auditor: Section 4 of the Standard, Applicability, guides the applicable protection to which this requirement, and R1 and R2, pertains.	

Auditor Notes:

--

Additional Information:

Reliability Standard

The RSAW developer should provide the following information without hyperlinks. Update the information below as appropriate.

The full text of STD-OXX-N may be found on the NERC Web Site (www.nerc.com) under “Program Areas & Departments”, “Reliability Standards.”

In addition to the Reliability Standard, there is an applicable Implementation Plan available on the NERC Web Site.

In addition to the Reliability Standard, there is background information available on the NERC Web Site.

Capitalized terms in the Reliability Standard refer to terms in the NERC Glossary, which may be found on the NERC Web Site.

Sampling Methodology [If developer deems reference applicable]

Sampling is essential for auditing compliance with NERC Reliability Standards since it is not always possible or practical to test 100% of either the equipment, documentation, or both, associated with the full suite of enforceable standards. The Sampling Methodology Guidelines and Criteria (see NERC website), or sample guidelines, provided by the Electric Reliability Organization help to establish a minimum sample set for monitoring and enforcement uses in audits of NERC Reliability Standards.

Regulatory Language [Developer to ensure RSAW has been provided to NERC Legal for links to appropriate Regulatory Language – See example below]

E.g. FERC Order No. 742 paragraph 34: “Based on NERC’s.....”

E.g. FERC Order No. 742 Paragraph 55, Commission Determination: “We affirm NERC’s.....”

Selected Glossary Terms [If developer deems applicable]

The following Glossary terms are provided for convenience only. Please refer to the NERC web site for the current enforceable terms.

DRAFT NERC Reliability Standard Audit Worksheet

Revision History for RSAW

Version	Date	Reviewers	Revision Description
1	4/29/19	NERC Compliance Assurance, RSAW Task Force	Draft to accompany first posting

ⁱ Items in the Evidence Requested section are suggested evidence that may, but will not necessarily, demonstrate compliance. These items are not mandatory and other forms and types of evidence may be submitted at the entity's discretion.

DRAFT

Standards Announcement

Project 2018-04 Modifications to PRC-024-2

Initial Ballot and Non-ballot Poll Open through May 31, 2019

[Now Available](#)

The initial ballot and non-binding poll for **PRC-024-3 – Generator Frequency and Voltage Protection Settings** are open until **8 p.m. Eastern, Friday, May 31, 2019**.

Balloting

Members of the ballot pools associated with this project can log into the [Standards Balloting and Commenting System \(SBS\)](#) and submit their votes. If you experience issues using the SBS, contact [Wendy Muller](#).

- *If you are having difficulty accessing the SBS due to a forgotten password, incorrect credential error messages, or system lock-out, contact NERC IT support directly at <https://support.nerc.net/> (Monday – Friday, 8 a.m. - 5 p.m. Eastern).*
- *Passwords expire every **6 months** and must be reset.*
- *The SBS **is not** supported for use on mobile devices.*
- *Please be mindful of ballot and comment period closing dates. We ask to **allow at least 48 hours** for NERC support staff to assist with inquiries. Therefore, it is recommended that users try logging into their SBS accounts **prior to the last day** of a comment/ballot period.*

Next Steps

The ballot results will be announced and posted on the project page. The drafting team will review all responses received during the comment period and determine the next steps of the project.

For information on the Standards Development Process, refer to the [Standard Processes Manual](#).

For more information or assistance, contact Standards Developer, [Mat Bunch](#) (via email) or at (404) 446-9785.

North American Electric Reliability Corporation
3353 Peachtree Rd, NE
Suite 600, North Tower
Atlanta, GA 30326
404-446-2560 | www.nerc.com

Standards Announcement

Project 2018-04 Modifications to PRC-024-2

45-day Formal Comment Period Open through May 31, 2019
Ballot Pools Forming through May 16, 2019

[Now Available](#)

A 45-day comment period for **PRC-024-3 – Generator Frequency and Voltage Protection Settings** is open until **8 p.m. Eastern, Friday, May 31, 2019**.

The standard drafting team is holding an [Industry Webinar](#) **1:00 to 2:00 p.m. Eastern, Tuesday, April 30, 2019** to review the modifications in proposed PRC-024-3.

Commenting

Use the [Standards Balloting and Commenting System \(SBS\)](#) to submit comments. If you experience issues using the SBS, contact [Wendy Muller](#). An unofficial Word version of the comment form is posted on the [project page](#).

Ballot Pools

Ballot pools are being formed through **8 p.m. Eastern, Thursday, May 16, 2019**. Registered Ballot Body members can join the ballot pools [here](#).

- *If you are having difficulty accessing the SBS due to a forgotten password, incorrect credential error messages, or system lock-out, contact NERC IT support directly at <https://support.nerc.net/> (Monday – Friday, 8 a.m. - 5 p.m. Eastern).*
- *Passwords expire every **6 months** and must be reset.*
- *The SBS is **not** supported for use on mobile devices.*
- *Please be mindful of ballot and comment period closing dates. We ask to **allow at least 48 hours** for NERC support staff to assist with inquiries. Therefore, it is recommended that users try logging into their SBS accounts **prior to the last day** of a comment/ballot period.*

Next Steps

A 10-day initial ballot for the standard and a non-binding poll of the associated Violation Risk Factors and Violation Severity Levels, will be conducted **May 22-31, 2019**.

For information on the Standards Development Process, refer to the [Standard Processes Manual](#).

For more information or assistance, contact Standards Developer, [Mat Bunch](#) (via email) or at (404) 446-9785.

North American Electric Reliability Corporation
3353 Peachtree Rd, NE
Suite 600, North Tower
Atlanta, GA 30326
404-446-2560 | www.nerc.com

BALLOT RESULTS

Comment: [View Comment Results \(/CommentResults/Index/169\)](#)

Ballot Name: 2018-04 Modifications to PRC-024-2 PRC-024-3 IN 1 ST

Voting Start Date: 5/22/2019 12:01:00 AM

Voting End Date: 5/31/2019 8:00:00 PM

Ballot Type: ST

Ballot Activity: IN

Ballot Series: 1

Total # Votes: 266

Total Ballot Pool: 301

Quorum: 88.37

Quorum Established Date: 5/31/2019 11:14:28 AM

Weighted Segment Value: 52.28

Segment	Ballot Pool	Segment Weight	Affirmative Votes	Affirmative Fraction	Negative Votes w/ Comment	Negative Fraction w/ Comment	Negative Votes w/o Comment	Abstain	No Vote
Segment: 1	74	1	31	0.492	32	0.508	0	3	8
Segment: 2	7	0.6	5	0.5	1	0.1	0	0	1
Segment: 3	74	1	31	0.492	32	0.508	0	2	9
Segment: 4	18	1	8	0.533	7	0.467	0	0	3
Segment: 5	71	1	31	0.492	32	0.508	0	1	7
Segment: 6	48	1	19	0.475	21	0.525	0	2	6
Segment: 7	0	0	0	0	0	0	0	0	0
Segment: 8	1	0	0	0	0	0	0	1	0
Segment: 9	1	0	0	0	0	0	0	1	0

Segment	Ballot Pool	Segment Weight	Affirmative Votes	Affirmative Fraction	Negative Votes w/ Comment	Negative Fraction w/ Comment	Negative Votes w/o Comment	Abstain	No Vote
Segment: 10	7	0.3	1	0.1	2	0.2	0	3	1
Totals:	301	5.9	126	3.085	127	2.815	0	13	35

BALLOT POOL MEMBERS

Show entries

Search:

Segment	Organization	Voter	Designated Proxy	Ballot	NERC Memo
1	AEP - AEP Service Corporation	Dennis Sauriol		Negative	Comments Submitted
1	Allete - Minnesota Power, Inc.	Jamie Monette		Negative	Comments Submitted
1	Ameren - Ameren Services	Eric Scott		Affirmative	N/A
1	APS - Arizona Public Service Co.	Michelle Amarantos		Negative	Comments Submitted
1	Arizona Electric Power Cooperative, Inc.	John Shaver		Negative	Third-Party Comments
1	Associated Electric Cooperative, Inc.	Ryan Ziegler		Negative	Third-Party Comments
1	Avista - Avista Corporation	Mike Magruder		Negative	Comments Submitted
1	Balancing Authority of Northern California	Kevin Smith	Joe Tarantino	Affirmative	N/A
1	BC Hydro and Power Authority	Adrian Andreoiu		Affirmative	N/A
1	Beaches Energy Services	Don Cuevas	Brandon McCormick	Affirmative	N/A

Segment	Organization	Voter	Designated Proxy	Ballot	NERC Memo
1	Black Hills Corporation	Wes Wingen		Affirmative	N/A
1	Bonneville Power Administration	Kammy Rogers-Holliday		Affirmative	N/A
1	CenterPoint Energy Houston Electric, LLC	Daniela Hammons		Negative	Comments Submitted
1	Central Electric Power Cooperative (Missouri)	Michael Bax		Negative	Third-Party Comments
1	City Utilities of Springfield, Missouri	Michael Buyce		Affirmative	N/A
1	CMS Energy - Consumers Energy Company	Donald Lynd		Negative	Comments Submitted
1	Colorado Springs Utilities	Devin Elverdi		Affirmative	N/A
1	Con Ed - Consolidated Edison Co. of New York	Dermot Smyth		Affirmative	N/A
1	Dairyland Power Cooperative	Renee Leidel		Negative	Third-Party Comments
1	Dominion - Dominion Virginia Power	Larry Nash		Negative	Comments Submitted
1	Duke Energy	Laura Lee		Affirmative	N/A
1	Edison International - Southern California Edison Company	Steven Mavis		Negative	Third-Party Comments
1	Entergy - Entergy Services, Inc.	Oliver Burke		Affirmative	N/A
1	Exelon	Daniel Gacek		Negative	Comments Submitted
1	FirstEnergy - FirstEnergy Corporation	Julie Severino		None	N/A
1	Gainesville Regional Utilities	David Owens	Brandon McCormick	Affirmative	N/A
1	Georgia Transmission Corporation	Greg Davis		Affirmative	N/A
1	Glencoe Light and Power Company	Terry Volkmann		Negative	Third-Party Comments

Segment	Organization	Voter	Designated Proxy	Ballot	NERC Memo
1	Great Plains Energy - Kansas City Power and Light Co.	James McBee		Negative	Third-Party Comments
1	Great River Energy	Gordon Pietsch		Negative	Third-Party Comments
1	Hydro-Quebec TransEnergie	Nicolas Turcotte		Affirmative	N/A
1	Imperial Irrigation District	Jesus Sammy Alcaraz		Negative	Comments Submitted
1	Lakeland Electric	Larry Watt		None	N/A
1	Lincoln Electric System	Danny Pudenz		Negative	Comments Submitted
1	Los Angeles Department of Water and Power	faranak sarbaz		Affirmative	N/A
1	Lower Colorado River Authority	Matthew Lewis		Affirmative	N/A
1	M and A Electric Power Cooperative	William Price		None	N/A
1	Manitoba Hydro	Mike Smith		Affirmative	N/A
1	Muscatine Power and Water	Andy Kurriger		None	N/A
1	N.W. Electric Power Cooperative, Inc.	Mark Ramsey		Negative	Third-Party Comments
1	National Grid USA	Michael Jones		Negative	Third-Party Comments
1	Nebraska Public Power District	Jamison Cawley		Negative	Comments Submitted
1	New York Power Authority	Salvatore Spagnolo		Negative	Comments Submitted
1	NextEra Energy - Florida Power and Light Co.	Mike O'Neil		Affirmative	N/A
1	NiSource - Northern Indiana Public Service Co.	Steve Toosevich		Affirmative	N/A

Segment	Organization	Voter	Designated Proxy	Ballot	NERC Memo
1	Northeast Missouri Electric Power Cooperative	Kevin White		Negative	Third-Party Comments
1	OGE Energy - Oklahoma Gas and Electric Co.	Terri Pyle		Negative	Third-Party Comments
1	Oncor Electric Delivery	Lee Maurer	Eric Shaw	None	N/A
1	Orlando Utilities Commission	Aaron Staley		None	N/A
1	Platte River Power Authority	Matt Thompson		Affirmative	N/A
1	PPL Electric Utilities Corporation	Brenda Truhe		Affirmative	N/A
1	PSEG - Public Service Electric and Gas Co.	Joseph Smith		Abstain	N/A
1	Public Utility District No. 1 of Chelan County	Jeff Kimbell		Affirmative	N/A
1	Public Utility District No. 1 of Snohomish County	Long Duong		Affirmative	N/A
1	Puget Sound Energy, Inc.	Theresa Rakowsky		Affirmative	N/A
1	Sacramento Municipal Utility District	Arthur Starkovich	Joe Tarantino	Affirmative	N/A
1	Salt River Project	Steven Cobb		Negative	Comments Submitted
1	Santee Cooper	Chris Wagner		Affirmative	N/A
1	SaskPower	Wayne Guttormson		Affirmative	N/A
1	SCANA - South Carolina Electric and Gas Co.	Tom Hanzlik		Negative	Comments Submitted
1	Seattle City Light	Pawel Krupa		Negative	Comments Submitted
1	Seminole Electric Cooperative, Inc.	Mark Churilla		Negative	Comments Submitted
1	Sempra - San Diego Gas and Electric	Mo Derbas		Affirmative	N/A

© 2020 - NERC Ver 4.3.0.0 Machine Name: ERODVSWB02

Segment	Organization	Voter	Designated Proxy	Ballot	NERC Memo
1	Sho-Me Power Electric Cooperative	Peter Dawson		None	N/A
1	Southern Company - Southern Company Services, Inc.	Adrienne Collins		Negative	Comments Submitted
1	Tacoma Public Utilities (Tacoma, WA)	John Merrell		Affirmative	N/A
1	Tallahassee Electric (City of Tallahassee, FL)	Scott Langston		Negative	Comments Submitted
1	Tennessee Valley Authority	Gabe Kurtz		Negative	Comments Submitted
1	Tri-State G and T Association, Inc.	Tracy Sliman		Abstain	N/A
1	U.S. Bureau of Reclamation	Richard Jackson		Affirmative	N/A
1	Unisource - Tucson Electric Power Co.	John Tolo		None	N/A
1	Westar Energy	Allen Klassen	Douglas Webb	Negative	Comments Submitted
1	Western Area Power Administration	sean erickson		Abstain	N/A
1	Xcel Energy, Inc.	Dean Schiro		Affirmative	N/A
2	California ISO	Richard Vine		Affirmative	N/A
2	Electric Reliability Council of Texas, Inc.	Brandon Gleason		Negative	Third-Party Comments
2	Independent Electricity System Operator	Leonard Kula		Affirmative	N/A
2	Midcontinent ISO, Inc.	Bobbi Welch		None	N/A
2	New York Independent System Operator	Gregory Campoli		Affirmative	N/A
2	PJM Interconnection, L.L.C.	Mark Holman		Affirmative	N/A
2	Southwest Power Pool, Inc. (RTO)	Charles Yeung		Affirmative	N/A

Segment	Organization	Voter	Designated Proxy	Ballot	NERC Memo
3	AEP	Leanna Lamatrice		Negative	Comments Submitted
3	AES - Indianapolis Power and Light Co.	Bette White		Affirmative	N/A
3	Ameren - Ameren Services	David Jendras		Affirmative	N/A
3	APS - Arizona Public Service Co.	Vivian Moser		Negative	Comments Submitted
3	Associated Electric Cooperative, Inc.	Todd Bennett		Negative	Comments Submitted
3	Austin Energy	W. Dwayne Preston		Negative	Third-Party Comments
3	Avista - Avista Corporation	Scott Kinney		Negative	Comments Submitted
3	BC Hydro and Power Authority	Hootan Jarollahi		Affirmative	N/A
3	Beaches Energy Services	Steven Lancaster	Brandon McCormick	Affirmative	N/A
3	Berkshire Hathaway Energy - MidAmerican Energy Co.	Darnez Gresham		Negative	Comments Submitted
3	Black Hills Corporation	Eric Egge		Affirmative	N/A
3	Bonneville Power Administration	Rebecca Berdahl		Affirmative	N/A
3	Central Electric Power Cooperative (Missouri)	Adam Weber		Negative	Third-Party Comments
3	City Utilities of Springfield, Missouri	Scott Williams		Affirmative	N/A
3	CMS Energy - Consumers Energy Company	Karl Blaszkowski		Negative	Comments Submitted
3	Colorado Springs Utilities	Hillary Dobson		Affirmative	N/A
3	Con Ed - Consolidated Edison Co. of New York	Peter Yost		Affirmative	N/A
3	20 - NERC Ver 4.00 Cowitch, Inc. / EROD / SSIW / 02			Affirmative	N/A

Segment	Organization	Voter	Designated Proxy	Ballot	NERC Memo
3	CPS Energy	James Grimshaw		None	N/A
3	Dominion - Dominion Resources, Inc.	Connie Lowe		Negative	Comments Submitted
3	DTE Energy - Detroit Edison Company	Karie Barczak		Affirmative	N/A
3	Duke Energy	Lee Schuster		Affirmative	N/A
3	Edison International - Southern California Edison Company	Romel Aquino		Negative	Third-Party Comments
3	Eversource Energy	Sharon Flannery		None	N/A
3	Exelon	Kinte Whitehead		Negative	Comments Submitted
3	FirstEnergy - FirstEnergy Corporation	Aaron Ghodooshim		None	N/A
3	Florida Municipal Power Agency	Joe McKinney	Brandon McCormick	Affirmative	N/A
3	Gainesville Regional Utilities	Darko Kovac	Brandon McCormick	Affirmative	N/A
3	Georgia System Operations Corporation	Scott McGough		Affirmative	N/A
3	Great Plains Energy - Kansas City Power and Light Co.	John Carlson		Negative	Comments Submitted
3	Great River Energy	Brian Glover		Negative	Third-Party Comments
3	JEA	Garry Baker		Negative	Third-Party Comments
3	KAMO Electric Cooperative	Tony Gott		Negative	Third-Party Comments
3	Lakeland Electric	Patricia Boody		Affirmative	N/A
3	Lincoln Electric System	Jason Fortik		None	N/A
3	Los Angeles Department of Water and Power	Tony Skourtas		Affirmative	N/A
3	M and A Electric Power	Stephen Pogue		Negative	Third-Party Comments

Segment	Organization	Voter	Designated Proxy	Ballot	NERC Memo
3	Manitoba Hydro	Karim Abdel-Hadi		Affirmative	N/A
3	MGE Energy - Madison Gas and Electric Co.	Ronald Bauer		None	N/A
3	Muscatine Power and Water	Seth Shoemaker		Negative	Third-Party Comments
3	National Grid USA	Brian Shanahan		Negative	Third-Party Comments
3	Nebraska Public Power District	Tony Eddleman		Negative	Comments Submitted
3	New York Power Authority	David Rivera		Negative	Comments Submitted
3	NiSource - Northern Indiana Public Service Co.	Dmitriy Bazylyuk		Affirmative	N/A
3	North Carolina Electric Membership Corporation	doug white		Affirmative	N/A
3	Northeast Missouri Electric Power Cooperative	Skyler Wiegmann		Negative	Third-Party Comments
3	NW Electric Power Cooperative, Inc.	John Stickley		Negative	Third-Party Comments
3	Ocala Utility Services	Neville Bowen	Brandon McCormick	Affirmative	N/A
3	OGE Energy - Oklahoma Gas and Electric Co.	Donald Hargrove		Negative	Third-Party Comments
3	Omaha Public Power District	Aaron Smith		Negative	Third-Party Comments
3	Owensboro Municipal Utilities	Thomas Lyons		Abstain	N/A
3	Platte River Power Authority	Jeff Landis		Affirmative	N/A
3	PNM Resources - Public Service Company of New Mexico	Trevor Tidwell		None	N/A
3	Portland General Electric Co.	Dan Zollner		Affirmative	N/A

© 2020 - NERC Ver 4.3.0.0 Machine Name: ERODVBSWB02

Segment	Organization	Voter	Designated Proxy	Ballot	NERC Memo
3	PPL - Louisville Gas and Electric Co.	Joseph Bencomo		Affirmative	N/A
3	PSEG - Public Service Electric and Gas Co.	James Meyer		Abstain	N/A
3	Public Utility District No. 1 of Chelan County	Joyce Gundry		Affirmative	N/A
3	Puget Sound Energy, Inc.	Tim Womack		None	N/A
3	Sacramento Municipal Utility District	Nicole Looney	Joe Tarantino	Affirmative	N/A
3	Salt River Project	Zack Heim		Negative	Comments Submitted
3	Santee Cooper	James Poston		Affirmative	N/A
3	SCANA - South Carolina Electric and Gas Co.	Scott Parker		Negative	Comments Submitted
3	Seminole Electric Cooperative, Inc.	James Frauen		Negative	Comments Submitted
3	Sempra - San Diego Gas and Electric	Bridget Silvia		Affirmative	N/A
3	Sho-Me Power Electric Cooperative	Jeff Neas		Negative	Third-Party Comments
3	Silicon Valley Power - City of Santa Clara	Val Ridad		None	N/A
3	Snohomish County PUD No. 1	Holly Chaney		Affirmative	N/A
3	Southern Company - Alabama Power Company	Joel Dembowski		Negative	Comments Submitted
3	Tacoma Public Utilities (Tacoma, WA)	Marc Donaldson		Affirmative	N/A
3	TECO - Tampa Electric Co.	Ronald Donahey		None	N/A
3	Tennessee Valley Authority	Ian Grant		Negative	Comments Submitted
3	WEC Energy Group, Inc.	Thomas Breene		Negative	Third-Party Comments

Segment	Organization	Voter	Designated Proxy	Ballot	NERC Memo
3	Westar Energy	Bryan Taggart	Douglas Webb	Negative	Comments Submitted
3	Xcel Energy, Inc.	Michael Ibold		Affirmative	N/A
4	Alliant Energy Corporation Services, Inc.	Larry Heckert		Negative	Third-Party Comments
4	Austin Energy	Esther Weekes		Negative	Comments Submitted
4	City Utilities of Springfield, Missouri	John Allen		Affirmative	N/A
4	CMS Energy - Consumers Energy Company	Theresa Martinez		Negative	Comments Submitted
4	FirstEnergy - FirstEnergy Corporation	Mark Garza		None	N/A
4	Florida Municipal Power Agency	Carol Chinn	Brandon McCormick	Affirmative	N/A
4	Georgia System Operations Corporation	Andrea Barclay		Affirmative	N/A
4	Indiana Municipal Power Agency	Jack Alvey	Scott Berry	Negative	Comments Submitted
4	Keys Energy Services	Nick Batty	Brandon McCormick	Affirmative	N/A
4	MGE Energy - Madison Gas and Electric Co.	Joseph DePoorter		Negative	Third-Party Comments
4	North Carolina Electric Membership Corporation	John Lemire		Affirmative	N/A
4	Oklahoma Municipal Power Authority	Ashley Stringer		None	N/A
4	Public Utility District No. 1 of Snohomish County	John Martinsen		Affirmative	N/A
4	Public Utility District No. 2 of Grant County, Washington	Karla Weaver		None	N/A
4	Sacramento Municipal Utility District	Beth Tincher	Joe Tarantino	Affirmative	N/A

© 2020 - NERC Ver 4.3.0.0 Machine Name: ERODVBSWB02

Segment	Organization	Voter	Designated Proxy	Ballot	NERC Memo
4	Seattle City Light	Hao Li		Negative	Comments Submitted
4	Tacoma Public Utilities (Tacoma, WA)	Hien Ho		Affirmative	N/A
4	Utility Services, Inc.	Brian Evans-Mongeon		Negative	Third-Party Comments
5	AEP	Thomas Foltz		Negative	Comments Submitted
5	AES - AES Corporation	Leo Bernier		Affirmative	N/A
5	Ameren - Ameren Missouri	Sam Dwyer		Affirmative	N/A
5	APS - Arizona Public Service Co.	Kelsi Rigby		Negative	Comments Submitted
5	Associated Electric Cooperative, Inc.	Brad Haralson		Negative	Comments Submitted
5	Austin Energy	Shirley Mathew		Negative	Comments Submitted
5	Avista - Avista Corporation	Glen Farmer		Negative	Comments Submitted
5	Basin Electric Power Cooperative	Mike Kraft		Negative	Comments Submitted
5	Berkshire Hathaway - NV Energy	Kevin Salsbury		Negative	Comments Submitted
5	Black Hills Corporation	George Tatar		Affirmative	N/A
5	Bonneville Power Administration	Scott Winner		Affirmative	N/A
5	Brazos Electric Power Cooperative, Inc.	Shari Heino		Negative	Third-Party Comments
5	Choctaw Generation Limited Partnership, LLLP	Rob Watson		Negative	Third-Party Comments
5	City of Independence, Power and Light Department	Jim Nail		Affirmative	N/A
5	City Water, Light and Power - Springfield	Steve Rose		Affirmative	N/A

Segment	Organization	Voter	Designated Proxy	Ballot	NERC Memo
5	CMS Energy - Consumers Energy Company	David Greyerbiehl		Negative	Comments Submitted
5	Con Ed - Consolidated Edison Co. of New York	William Winters	Daniel Valle	Affirmative	N/A
5	Cowlitz County PUD	Deanna Carlson		Affirmative	N/A
5	Dairyland Power Cooperative	Tommy Drea		Negative	Third-Party Comments
5	Dominion - Dominion Resources, Inc.	Lou Oberski		Negative	Comments Submitted
5	DTE Energy - Detroit Edison Company	Jeffrey DePriest		Affirmative	N/A
5	Duke Energy	Dale Goodwine		Affirmative	N/A
5	Edison International - Southern California Edison Company	Neil Shockey		None	N/A
5	Exelon	Cynthia Lee		Negative	Comments Submitted
5	FirstEnergy - FirstEnergy Solutions	Robert Loy		None	N/A
5	Florida Municipal Power Agency	Chris Gowder	Brandon McCormick	Affirmative	N/A
5	Great Plains Energy - Kansas City Power and Light Co.	Marcus Moor		Negative	Comments Submitted
5	Great River Energy	Preston Walsh		Negative	Third-Party Comments
5	Herb Schrayshuen	Herb Schrayshuen		Affirmative	N/A
5	Imperial Irrigation District	Tino Zaragoza		Negative	Comments Submitted
5	Lakeland Electric	Jim Howard		Affirmative	N/A
5	Lincoln Electric System	Kayleigh Wilkerson		Negative	Comments Submitted
5	Los Angeles Department of Water and Power	Glenn Barry		None	N/A

Segment	Organization	Voter	Designated Proxy	Ballot	NERC Memo
5	Lower Colorado River Authority	Teresa Cantwell		Affirmative	N/A
5	Manitoba Hydro	Yuguang Xiao		Affirmative	N/A
5	Massachusetts Municipal Wholesale Electric Company	David Gordon		Abstain	N/A
5	MGE Energy - Madison Gas and Electric Co.	Steven Schultz		None	N/A
5	National Grid USA	Elizabeth Spivak		None	N/A
5	NaturEner USA, LLC	Eric Smith		Affirmative	N/A
5	NB Power Corporation	Laura McLeod		Affirmative	N/A
5	New York Power Authority	Shivaz Chopra		Negative	Comments Submitted
5	NextEra Energy	Allen Schriver		Negative	Comments Submitted
5	NiSource - Northern Indiana Public Service Co.	Kathryn Tackett		Affirmative	N/A
5	North Carolina Electric Membership Corporation	Robert Beadle		Affirmative	N/A
5	Northern California Power Agency	Marty Hostler		None	N/A
5	OGE Energy - Oklahoma Gas and Electric Co.	Patrick Wells		Negative	Third-Party Comments
5	Oglethorpe Power Corporation	Donna Johnson		Affirmative	N/A
5	Omaha Public Power District	Mahmood Safi		Negative	Third-Party Comments
5	Ontario Power Generation Inc.	Constantin Chitescu		Negative	Comments Submitted
5	Platte River Power Authority	Tyson Archie		Affirmative	N/A
5	PPL - Louisville Gas and Electric Co.	JULIE HOSTRANDER		Affirmative	N/A

Segment	Organization	Voter	Designated Proxy	Ballot	NERC Memo
5	PSEG - PSEG Fossil LLC	Tim Kucey		None	N/A
5	Public Utility District No. 1 of Chelan County	Meaghan Connell		Affirmative	N/A
5	Public Utility District No. 1 of Snohomish County	Sam Nietfeld		Affirmative	N/A
5	Puget Sound Energy, Inc.	Eleanor Ewry		Affirmative	N/A
5	Sacramento Municipal Utility District	Susan Oto	Joe Tarantino	Affirmative	N/A
5	Salt River Project	Kevin Nielsen		Negative	Comments Submitted
5	Santee Cooper	Tommy Curtis		Affirmative	N/A
5	SCANA - South Carolina Electric and Gas Co.	Alyssa Hubbard		Negative	Comments Submitted
5	Seattle City Light	Faz Kasraie		Negative	Comments Submitted
5	Seminole Electric Cooperative, Inc.	James Woodall		Negative	Comments Submitted
5	Sempra - San Diego Gas and Electric	Jennifer Wright		Affirmative	N/A
5	Southern Company - Southern Company Generation	William D. Shultz		Negative	Comments Submitted
5	SunPower	Bradley Collard		Negative	Comments Submitted
5	Tacoma Public Utilities (Tacoma, WA)	Ozan Ferrin		Affirmative	N/A
5	Talen Generation, LLC	Matthew McMillan		Negative	Comments Submitted
5	U.S. Bureau of Reclamation	Wendy Center		Affirmative	N/A
5	Vistra Energy	Dan Roethemeyer		Negative	Comments Submitted
5	WEC Energy Group, Inc.	Linda Horn		Negative	Third-Party Comments

© 2020 - NERC Ver 4.3.0.0 Machine Name: ERODVSWB02

Segment	Organization	Voter	Designated Proxy	Ballot	NERC Memo
5	Westar Energy	Derek Brown	Douglas Webb	Negative	Comments Submitted
5	Xcel Energy, Inc.	Gerry Huitt	Amy Casuscelli	Affirmative	N/A
6	AEP - AEP Marketing	Yee Chou		Negative	Comments Submitted
6	Ameren - Ameren Services	Robert Quinlivan		Affirmative	N/A
6	APS - Arizona Public Service Co.	Chinedu Ochonogor		Negative	Comments Submitted
6	Associated Electric Cooperative, Inc.	Brian Ackermann		Negative	Comments Submitted
6	Berkshire Hathaway - PacifiCorp	Sandra Shaffer		Negative	Comments Submitted
6	Black Hills Corporation	Eric Scherr		Affirmative	N/A
6	Bonneville Power Administration	Andrew Meyers		Affirmative	N/A
6	Cleco Corporation	Robert Hirschak	Louis Guidry	Affirmative	N/A
6	Con Ed - Consolidated Edison Co. of New York	Christopher Overberg		Affirmative	N/A
6	Dominion - Dominion Resources, Inc.	Sean Bodkin		Negative	Comments Submitted
6	Duke Energy	Greg Cecil		None	N/A
6	Edison International - Southern California Edison Company	Kenya Streeter		Negative	Third-Party Comments
6	Exelon	Becky Webb		Negative	Comments Submitted
6	FirstEnergy - FirstEnergy Solutions	Ann Carey		None	N/A
6	Florida Municipal Power Agency	Richard Montgomery	Brandon McCormick	Affirmative	N/A
6	Florida Municipal Power Pool	Tom Reedy	Brandon McCormick	Affirmative	N/A

Segment	Organization	Voter	Designated Proxy	Ballot	NERC Memo
6	Great Plains Energy - Kansas City Power and Light Co.	Jennifer Flandermeyer		Negative	Comments Submitted
6	Great River Energy	Donna Stephenson	Michael Brytowski	Negative	Third-Party Comments
6	Lakeland Electric	Paul Shipps		Affirmative	N/A
6	Lincoln Electric System	Eric Ruskamp		Negative	Comments Submitted
6	Los Angeles Department of Water and Power	Anton Vu		Affirmative	N/A
6	Manitoba Hydro	Blair Mukanik		Affirmative	N/A
6	MGE Energy - Madison Gas and Electric Co.	Robert Thorson		None	N/A
6	Muscatine Power and Water	Ryan Streck		Negative	Third-Party Comments
6	New York Power Authority	Thomas Savin		Negative	Comments Submitted
6	NextEra Energy - Florida Power and Light Co.	Silvia Mitchell		Negative	Comments Submitted
6	NiSource - Northern Indiana Public Service Co.	Joe O'Brien		Affirmative	N/A
6	Northern California Power Agency	Dennis Sismaet		Abstain	N/A
6	OGE Energy - Oklahoma Gas and Electric Co.	Sing Tay		Negative	Third-Party Comments
6	Platte River Power Authority	Sabrina Martz		Affirmative	N/A
6	Portland General Electric Co.	Daniel Mason		Affirmative	N/A
6	Powerex Corporation	Gordon Dobson-Mack		None	N/A
6	PPL - Louisville Gas and Electric Co.	Linn Oelker		None	N/A

Segment	Organization	Voter	Designated Proxy	Ballot	NERC Memo
6	PSEG - PSEG Energy Resources and Trade LLC	Luigi Beretta		Abstain	N/A
6	Public Utility District No. 1 of Chelan County	Davis Jelusich		Affirmative	N/A
6	Public Utility District No. 2 of Grant County, Washington	LeRoy Patterson		None	N/A
6	Sacramento Municipal Utility District	Jamie Cutlip	Joe Tarantino	Affirmative	N/A
6	Santee Cooper	Michael Brown		Affirmative	N/A
6	Seattle City Light	Charles Freeman		Negative	Comments Submitted
6	Seminole Electric Cooperative, Inc.	Trudy Novak		Negative	Comments Submitted
6	Snohomish County PUD No. 1	Franklin Lu		Affirmative	N/A
6	Southern Company - Southern Company Generation	Ron Carlsen		Negative	Comments Submitted
6	Tacoma Public Utilities (Tacoma, WA)	Rick Applegate		Affirmative	N/A
6	Talen Energy Marketing, LLC	Jennifer Hohenshilt		Negative	Comments Submitted
6	Tennessee Valley Authority	Marjorie Parsons		Negative	Comments Submitted
6	WEC Energy Group, Inc.	David Hathaway		Negative	Third-Party Comments
6	Westar Energy	Grant Wilkerson	Douglas Webb	Negative	Comments Submitted
6	Xcel Energy, Inc.	Carrie Dixon		Affirmative	N/A
8	David Kiguel	David Kiguel		Abstain	N/A
9	Commonwealth of Massachusetts Department of Public Utilities	Donald Nelson		Abstain	N/A

Segment	Organization	Voter	Designated Proxy	Ballot	NERC Memo
10	Midwest Reliability Organization	Russel Mountjoy		Negative	Third-Party Comments
10	New York State Reliability Council	ALAN ADAMSON		Abstain	N/A
10	Northeast Power Coordinating Council	Guy V. Zito		Abstain	N/A
10	ReliabilityFirst	Anthony Jablonski		Affirmative	N/A
10	SERC Reliability Corporation	Dave Krueger		None	N/A
10	Texas Reliability Entity, Inc.	Rachel Coyne		Abstain	N/A
10	Western Electricity Coordinating Council	Steven Rueckert		Negative	Comments Submitted

Showing 1 to 301 of 301 entries

Previous 1 Next

BALLOT RESULTS

Ballot Name: 2018-04 Modifications to PRC-024-2 PRC-024-3 Non-binding Poll IN 1 NB

Voting Start Date: 5/22/2019 12:01:00 AM

Voting End Date: 5/31/2019 8:00:00 PM

Ballot Type: NB

Ballot Activity: IN

Ballot Series: 1

Total # Votes: 249

Total Ballot Pool: 284

Quorum: 87.68

Quorum Established Date: 5/31/2019 12:02:36 PM

Weighted Segment Value: 52.48

Segment	Ballot Pool	Segment Weight	Affirmative Votes	Affirmative Fraction	Negative Votes	Negative Fraction	Abstain	No Vote
Segment: 1	68	1	23	0.5	23	0.5	14	8
Segment: 2	7	0.4	4	0.4	0	0	2	1
Segment: 3	72	1	26	0.5	26	0.5	11	9
Segment: 4	17	1	7	0.583	5	0.417	2	3
Segment: 5	66	1	28	0.519	26	0.481	6	6
Segment: 6	46	1	16	0.5	16	0.5	7	7
Segment: 7	0	0	0	0	0	0	0	0
Segment: 8	1	0	0	0	0	0	1	0
Segment: 9	1	0.1	1	0.1	0	0	0	0
Segment: 10	6	0.1	1	0.1	0	0	4	1
Total	284	3.0	166	0.585	96	2.398	47	35

BALLOT POOL MEMBERSShow entriesSearch:

Segment	Organization	Voter	Designated Proxy	Ballot	NERC Memo
1	AEP - AEP Service Corporation	Dennis Sauriol		Negative	Comments Submitted
1	Ameren - Ameren Services	Eric Scott		Abstain	N/A
1	APS - Arizona Public Service Co.	Michelle Amarantos		Negative	Comments Submitted
1	Arizona Electric Power Cooperative, Inc.	John Shaver		Negative	Comments Submitted
1	Associated Electric Cooperative, Inc.	Ryan Ziegler		Negative	Comments Submitted
1	Avista - Avista Corporation	Mike Magruder		None	N/A
1	Balancing Authority of Northern California	Kevin Smith	Joe Tarantino	Affirmative	N/A
1	BC Hydro and Power Authority	Adrian Andreoiu		Abstain	N/A
1	Beaches Energy Services	Don Cuevas	Brandon McCormick	Affirmative	N/A
1	Bonneville Power Administration	Kammy Rogers-Holliday		Affirmative	N/A
1	CenterPoint Energy Houston Electric, LLC	Daniela Hammons		Abstain	N/A
1	Central Electric Power Cooperative (Missouri)	Michael Bax		Negative	Comments Submitted
1	City Utilities of Springfield, Missouri	Michael Buyce		Affirmative	N/A

© 2020 - NERC Ver 4.3.0.0 Machine Name: ERODVSWB02

Segment	Organization	Voter	Designated Proxy	Ballot	NERC Memo
1	CMS Energy - Consumers Energy Company	Donald Lynd		Negative	Comments Submitted
1	Colorado Springs Utilities	Devin Elverdi		Affirmative	N/A
1	Con Ed - Consolidated Edison Co. of New York	Dermot Smyth		Affirmative	N/A
1	Dairyland Power Cooperative	Renee Leidel		Negative	Comments Submitted
1	Dominion - Dominion Virginia Power	Larry Nash		Abstain	N/A
1	Duke Energy	Laura Lee		Affirmative	N/A
1	Edison International - Southern California Edison Company	Steven Mavis		Negative	Comments Submitted
1	Entergy - Entergy Services, Inc.	Oliver Burke		Affirmative	N/A
1	Exelon	Daniel Gacek		Abstain	N/A
1	FirstEnergy - FirstEnergy Corporation	Julie Severino		None	N/A
1	Gainesville Regional Utilities	David Owens	Brandon McCormick	Affirmative	N/A
1	Georgia Transmission Corporation	Greg Davis		Abstain	N/A
1	Glencoe Light and Power Commission	Terry Volkmann		Negative	Comments Submitted
1	Great Plains Energy - Kansas City Power and Light Co.	James McBee		Negative	Comments Submitted
1	Great River Energy	Gordon Pietsch		Negative	Comments Submitted
1	Imperial Irrigation District	Jesus Sammy Alcaraz		Negative	Comments Submitted
1	Lakeland Electric	Larry Watt		None	N/A
1	Lincoln Electric System	Danny Pudenz		Abstain	N/A

© 2020 - NERC Ver 4.3.0.0 Machine Name: ERODVSWB02

Segment	Organization	Voter	Designated Proxy	Ballot	NERC Memo
1	Los Angeles Department of Water and Power	faranak sarbaz		Affirmative	N/A
1	Lower Colorado River Authority	Matthew Lewis		Affirmative	N/A
1	M and A Electric Power Cooperative	William Price		None	N/A
1	Manitoba Hydro	Mike Smith		Affirmative	N/A
1	Muscatine Power and Water	Andy Kurriger		None	N/A
1	N.W. Electric Power Cooperative, Inc.	Mark Ramsey		Negative	Comments Submitted
1	National Grid USA	Michael Jones		Negative	Comments Submitted
1	Nebraska Public Power District	Jamison Cawley		Abstain	N/A
1	New York Power Authority	Salvatore Spagnolo		Negative	Comments Submitted
1	NextEra Energy - Florida Power and Light Co.	Mike O'Neil		Affirmative	N/A
1	NiSource - Northern Indiana Public Service Co.	Steve Toosevich		Affirmative	N/A
1	Northeast Missouri Electric Power Cooperative	Kevin White		Negative	Comments Submitted
1	OGE Energy - Oklahoma Gas and Electric Co.	Terri Pyle		Negative	Comments Submitted
1	Orlando Utilities Commission	Aaron Staley		None	N/A
1	PPL Electric Utilities Corporation	Brenda Truhe		Abstain	N/A
1	PSEG - Public Service Electric and Gas Co.	Joseph Smith		Abstain	N/A
1	Public Utility District No. 1 of Chelan County	Jeff Kimbell		Affirmative	N/A

Segment	Organization	Voter	Designated Proxy	Ballot	NERC Memo
1	Public Utility District No. 1 of Snohomish County	Long Duong		Affirmative	N/A
1	Puget Sound Energy, Inc.	Theresa Rakowsky		Affirmative	N/A
1	Sacramento Municipal Utility District	Arthur Starkovich	Joe Tarantino	Affirmative	N/A
1	Salt River Project	Steven Cobb		Negative	Comments Submitted
1	Santee Cooper	Chris Wagner		Affirmative	N/A
1	SaskPower	Wayne Guttormson		Affirmative	N/A
1	SCANA - South Carolina Electric and Gas Co.	Tom Hanzlik		Negative	Comments Submitted
1	Seattle City Light	Pawel Krupa		Negative	Comments Submitted
1	Seminole Electric Cooperative, Inc.	Mark Churilla		Abstain	N/A
1	Sempra - San Diego Gas and Electric	Mo Derbas		Affirmative	N/A
1	Sho-Me Power Electric Cooperative	Peter Dawson		None	N/A
1	Southern Company - Southern Company Services, Inc.	Adrienne Collins		Negative	Comments Submitted
1	Tacoma Public Utilities (Tacoma, WA)	John Merrell		Affirmative	N/A
1	Tallahassee Electric (City of Tallahassee, FL)	Scott Langston		Negative	Comments Submitted
1	Tennessee Valley Authority	Gabe Kurtz		Abstain	N/A
1	Tri-State G and T Association, Inc.	Tracy Sliman		Abstain	N/A
1	U.S. Bureau of Reclamation	Richard Jackson		Affirmative	N/A
1	Unisource - Tucson Electric Service Co.	John Tolo		None	N/A

© 2020 - NERC Ver 4.0.0 - Ballot Name: ERODVSBSWB02

Segment	Organization	Voter	Designated Proxy	Ballot	NERC Memo
1	Westar Energy	Allen Klassen	Douglas Webb	Negative	Comments Submitted
1	Western Area Power Administration	sean erickson		Abstain	N/A
2	California ISO	Richard Vine		Affirmative	N/A
2	Electric Reliability Council of Texas, Inc.	Brandon Gleason		Affirmative	N/A
2	Independent Electricity System Operator	Leonard Kula		Affirmative	N/A
2	Midcontinent ISO, Inc.	Bobbi Welch		None	N/A
2	New York Independent System Operator	Gregory Campoli		Abstain	N/A
2	PJM Interconnection, L.L.C.	Mark Holman		Affirmative	N/A
2	Southwest Power Pool, Inc. (RTO)	Charles Yeung		Abstain	N/A
3	AEP	Leanna Lamatrice		Negative	Comments Submitted
3	AES - Indianapolis Power and Light Co.	Bette White		Affirmative	N/A
3	Ameren - Ameren Services	David Jendras		Abstain	N/A
3	APS - Arizona Public Service Co.	Vivian Moser		Negative	Comments Submitted
3	Associated Electric Cooperative, Inc.	Todd Bennett		Negative	Comments Submitted
3	Austin Energy	W. Dwayne Preston		Negative	Comments Submitted
3	Avista - Avista Corporation	Scott Kinney		Abstain	N/A
3	BC Hydro and Power Authority	Hootan Jarollahi		Abstain	N/A
3	Beaches Energy Services	Steven Lancaster	Brandon McCormick	Affirmative	N/A

Segment	Organization	Voter	Designated Proxy	Ballot	NERC Memo
3	Berkshire Hathaway Energy - MidAmerican Energy Co.	Darnez Gresham		Negative	Comments Submitted
3	Black Hills Corporation	Eric Egge		Affirmative	N/A
3	Bonneville Power Administration	Rebecca Berdahl		Affirmative	N/A
3	Central Electric Power Cooperative (Missouri)	Adam Weber		Negative	Comments Submitted
3	City Utilities of Springfield, Missouri	Scott Williams		Affirmative	N/A
3	CMS Energy - Consumers Energy Company	Karl Blaszkowski		Negative	Comments Submitted
3	Colorado Springs Utilities	Hillary Dobson		Affirmative	N/A
3	Con Ed - Consolidated Edison Co. of New York	Peter Yost		Affirmative	N/A
3	Cowlitz County PUD	Russell Noble		Affirmative	N/A
3	CPS Energy	James Grimshaw		None	N/A
3	Dominion - Dominion Resources, Inc.	Connie Lowe		Abstain	N/A
3	DTE Energy - Detroit Edison Company	Karie Barczak		Affirmative	N/A
3	Duke Energy	Lee Schuster		Affirmative	N/A
3	Edison International - Southern California Edison Company	Romel Aquino		Negative	Comments Submitted
3	Eversource Energy	Sharon Flannery		None	N/A
3	Exelon	Kinte Whitehead		Abstain	N/A
3	FirstEnergy - FirstEnergy Corporation	Aaron Ghodooshim		None	N/A
3	Florida Municipal Power Agency	Joe McKinney	Brandon McCormick	Affirmative	N/A
3	Gainesville Regional Utilities	Darko Kovac	Brandon McCormick	Affirmative	N/A

Segment	Organization	Voter	Designated Proxy	Ballot	NERC Memo
3	Georgia System Operations Corporation	Scott McGough		Affirmative	N/A
3	Great Plains Energy - Kansas City Power and Light Co.	John Carlson		Negative	Comments Submitted
3	Great River Energy	Brian Glover		Negative	Comments Submitted
3	KAMO Electric Cooperative	Tony Gott		Negative	Comments Submitted
3	Lakeland Electric	Patricia Boody		Affirmative	N/A
3	Lincoln Electric System	Jason Fortik		None	N/A
3	Los Angeles Department of Water and Power	Tony Skourtas		Affirmative	N/A
3	M and A Electric Power Cooperative	Stephen Pogue		Negative	Comments Submitted
3	Manitoba Hydro	Karim Abdel-Hadi		Affirmative	N/A
3	Muscatine Power and Water	Seth Shoemaker		Negative	Comments Submitted
3	National Grid USA	Brian Shanahan		Negative	Comments Submitted
3	Nebraska Public Power District	Tony Eddleman		Abstain	N/A
3	New York Power Authority	David Rivera		Negative	Comments Submitted
3	NiSource - Northern Indiana Public Service Co.	Dmitriy Bazylyuk		Affirmative	N/A
3	North Carolina Electric Membership Corporation	doug white		Negative	Comments Submitted
3	Northeast Missouri Electric Power Cooperative	Skyler Wiegmann		Negative	Comments Submitted
3	NW Electric Power Cooperative, Inc.	John Stickley		Negative	Comments Submitted
3	Ocala Utility Services	Neville Bowen	Brandon McCormick	Affirmative	N/A

Segment	Organization	Voter	Designated Proxy	Ballot	NERC Memo
3	OGE Energy - Oklahoma Gas and Electric Co.	Donald Hargrove		Negative	Comments Submitted
3	Omaha Public Power District	Aaron Smith		Negative	Comments Submitted
3	Owensboro Municipal Utilities	Thomas Lyons		Abstain	N/A
3	Platte River Power Authority	Jeff Landis		Affirmative	N/A
3	PNM Resources - Public Service Company of New Mexico	Trevor Tidwell		None	N/A
3	Portland General Electric Co.	Dan Zollner		Affirmative	N/A
3	PPL - Louisville Gas and Electric Co.	James Frank		None	N/A
3	PSEG - Public Service Electric and Gas Co.	James Meyer		Abstain	N/A
3	Public Utility District No. 1 of Chelan County	Joyce Gundry		Affirmative	N/A
3	Puget Sound Energy, Inc.	Tim Womack		None	N/A
3	Sacramento Municipal Utility District	Nicole Looney	Joe Tarantino	Affirmative	N/A
3	Salt River Project	Zack Heim		Negative	Comments Submitted
3	Santee Cooper	James Poston		Affirmative	N/A
3	SCANA - South Carolina Electric and Gas Co.	Scott Parker		Negative	Comments Submitted
3	Seminole Electric Cooperative, Inc.	James Frauen		Abstain	N/A
3	Sempra - San Diego Gas and Electric	Bridget Silvia		Affirmative	N/A
3	Sho-Me Power Electric Cooperative	Jeff Neas		Negative	Comments Submitted
3	Silicon Valley Power - City of San Jose	Val Ridad		None	N/A

© 2020 - NERC Ver 4.0 City of San Jose Name: ERODVBSWB02

Segment	Organization	Voter	Designated Proxy	Ballot	NERC Memo
3	Snohomish County PUD No. 1	Holly Chaney		Affirmative	N/A
3	Southern Company - Alabama Power Company	Joel Dembowski		Negative	Comments Submitted
3	Tacoma Public Utilities (Tacoma, WA)	Marc Donaldson		Affirmative	N/A
3	TECO - Tampa Electric Co.	Ronald Donahey		None	N/A
3	Tennessee Valley Authority	Ian Grant		Abstain	N/A
3	WEC Energy Group, Inc.	Thomas Breene		Negative	Comments Submitted
3	Westar Energy	Bryan Taggart	Douglas Webb	Negative	Comments Submitted
3	Xcel Energy, Inc.	Michael Ibold		Abstain	N/A
4	Alliant Energy Corporation Services, Inc.	Larry Heckert		None	N/A
4	Austin Energy	Esther Weekes		Negative	Comments Submitted
4	City Utilities of Springfield, Missouri	John Allen		Affirmative	N/A
4	CMS Energy - Consumers Energy Company	Theresa Martinez		Negative	Comments Submitted
4	FirstEnergy - FirstEnergy Corporation	Mark Garza		None	N/A
4	Florida Municipal Power Agency	Carol Chinn	Brandon McCormick	Affirmative	N/A
4	Georgia System Operations Corporation	Andrea Barclay		Affirmative	N/A
4	Indiana Municipal Power Agency	Jack Alvey	Scott Berry	Negative	Comments Submitted
4	Keys Energy Services	Nick Batty	Brandon McCormick	Affirmative	N/A

© 2020 - NERC Ver 4.3.0.0 Machine Name: ERODVSBWB02

Segment	Organization	Voter	Designated Proxy	Ballot	NERC Memo
4	MGE Energy - Madison Gas and Electric Co.	Joseph DePoorter		Abstain	N/A
4	North Carolina Electric Membership Corporation	John Lemire		Negative	Comments Submitted
4	Public Utility District No. 1 of Snohomish County	John Martinsen		Affirmative	N/A
4	Public Utility District No. 2 of Grant County, Washington	Karla Weaver		None	N/A
4	Sacramento Municipal Utility District	Beth Tincher	Joe Tarantino	Affirmative	N/A
4	Seattle City Light	Hao Li		Negative	Comments Submitted
4	Tacoma Public Utilities (Tacoma, WA)	Hien Ho		Affirmative	N/A
4	Utility Services, Inc.	Brian Evans-Mongeon		Abstain	N/A
5	AEP	Thomas Foltz		Negative	Comments Submitted
5	AES - AES Corporation	Leo Bernier		Affirmative	N/A
5	Ameren - Ameren Missouri	Sam Dwyer		Abstain	N/A
5	APS - Arizona Public Service Co.	Kelsi Rigby		Negative	Comments Submitted
5	Associated Electric Cooperative, Inc.	Brad Haralson		Negative	Comments Submitted
5	Austin Energy	Shirley Mathew		Negative	Comments Submitted
5	Avista - Avista Corporation	Glen Farmer		Negative	Comments Submitted
5	Basin Electric Power Cooperative	Mike Kraft		Negative	Comments Submitted
5	Berkshire Hathaway - NV Energy	Kevin Salsbury		Negative	Comments Submitted
5	Black Hills Corporation	George Tatar		Affirmative	N/A

© 2020 - NERC Ver 4.3.0.0 Machine Name: ERODVSWB02

Segment	Organization	Voter	Designated Proxy	Ballot	NERC Memo
5	Bonneville Power Administration	Scott Winner		Affirmative	N/A
5	Brazos Electric Power Cooperative, Inc.	Shari Heino		Negative	Comments Submitted
5	Choctaw Generation Limited Partnership, LLLP	Rob Watson		Negative	Comments Submitted
5	City of Independence, Power and Light Department	Jim Nail		Affirmative	N/A
5	City Water, Light and Power of Springfield, IL	Steve Rose		Affirmative	N/A
5	CMS Energy - Consumers Energy Company	David Greyerbiehl		Negative	Comments Submitted
5	Con Ed - Consolidated Edison Co. of New York	William Winters	Daniel Valle	Affirmative	N/A
5	Cowlitz County PUD	Deanna Carlson		Affirmative	N/A
5	Dairyland Power Cooperative	Tommy Drea		Negative	Comments Submitted
5	Dominion - Dominion Resources, Inc.	Lou Oberski		Negative	Comments Submitted
5	DTE Energy - Detroit Edison Company	Jeffrey DePriest		Affirmative	N/A
5	Duke Energy	Dale Goodwine		Affirmative	N/A
5	Edison International - Southern California Edison Company	Neil Shockey		None	N/A
5	Exelon	Cynthia Lee		Abstain	N/A
5	FirstEnergy - FirstEnergy Solutions	Robert Loy		None	N/A
5	Florida Municipal Power Agency	Chris Gowder	Brandon McCormick	Affirmative	N/A
5	Great Plains Energy - Kansas City Power and Light Co.	Marcus Moor		Negative	Comments Submitted

© 2020 - NERC Ver 4.3.0.0 Machine Name: ERODVBSWB02

Segment	Organization	Voter	Designated Proxy	Ballot	NERC Memo
5	Great River Energy	Preston Walsh		Negative	Comments Submitted
5	Herb Schrayshuen	Herb Schrayshuen		Affirmative	N/A
5	Imperial Irrigation District	Tino Zaragoza		Negative	Comments Submitted
5	Lakeland Electric	Jim Howard		Affirmative	N/A
5	Lincoln Electric System	Kayleigh Wilkerson		Abstain	N/A
5	Los Angeles Department of Water and Power	Glenn Barry		None	N/A
5	Lower Colorado River Authority	Teresa Cantwell		Affirmative	N/A
5	Manitoba Hydro	Yuguang Xiao		Affirmative	N/A
5	Massachusetts Municipal Wholesale Electric Company	David Gordon		Abstain	N/A
5	NaturEner USA, LLC	Eric Smith		Affirmative	N/A
5	NB Power Corporation	Laura McLeod		Affirmative	N/A
5	New York Power Authority	Shivaz Chopra		Negative	Comments Submitted
5	NextEra Energy	Allen Schriver		Negative	Comments Submitted
5	NiSource - Northern Indiana Public Service Co.	Kathryn Tackett		Affirmative	N/A
5	North Carolina Electric Membership Corporation	Robert Beadle		Negative	Comments Submitted
5	Northern California Power Agency	Marty Hostler		None	N/A
5	OGE Energy - Oklahoma Gas and Electric Co.	Patrick Wells		Negative	Comments Submitted
5	Oglethorpe Power Corporation	Donna Johnson		Affirmative	N/A

Segment	Organization	Voter	Designated Proxy	Ballot	NERC Memo
5	Omaha Public Power District	Mahmood Safi		Negative	Comments Submitted
5	Ontario Power Generation Inc.	Constantin Chitescu		Affirmative	N/A
5	Platte River Power Authority	Tyson Archie		Affirmative	N/A
5	PPL - Louisville Gas and Electric Co.	JULIE HOSTRANDER		None	N/A
5	PSEG - PSEG Fossil LLC	Tim Kucey		None	N/A
5	Public Utility District No. 1 of Chelan County	Meaghan Connell		Affirmative	N/A
5	Public Utility District No. 1 of Snohomish County	Sam Nietfeld		Affirmative	N/A
5	Puget Sound Energy, Inc.	Eleanor Ewry		Affirmative	N/A
5	Sacramento Municipal Utility District	Susan Oto	Joe Tarantino	Affirmative	N/A
5	Salt River Project	Kevin Nielsen		Negative	Comments Submitted
5	Santee Cooper	Tommy Curtis		Affirmative	N/A
5	SCANA - South Carolina Electric and Gas Co.	Alyssa Hubbard		Negative	Comments Submitted
5	Seattle City Light	Faz Kasraie		Negative	Comments Submitted
5	Seminole Electric Cooperative, Inc.	James Woodall		Abstain	N/A
5	Sempra - San Diego Gas and Electric	Jennifer Wright		Affirmative	N/A
5	Southern Company - Southern Company Generation	William D. Shultz		Abstain	N/A
5	SunPower	Bradley Collard		Negative	Comments Submitted
5	Tacoma Public Utilities	Ozan Ferrin		Affirmative	N/A

© 2020 - NERC Ver 4.3.00 Machine Name: ERODVBSWB02

Segment	Organization	Voter	Designated Proxy	Ballot	NERC Memo
5	U.S. Bureau of Reclamation	Wendy Center		Affirmative	N/A
5	Vistra Energy	Dan Roethemeyer		Negative	Comments Submitted
5	Westar Energy	Derek Brown	Douglas Webb	Negative	Comments Submitted
6	AEP - AEP Marketing	Yee Chou		Negative	Comments Submitted
6	Ameren - Ameren Services	Robert Quinlivan		Abstain	N/A
6	APS - Arizona Public Service Co.	Chinedu Ochonogor		Negative	Comments Submitted
6	Associated Electric Cooperative, Inc.	Brian Ackermann		Negative	Comments Submitted
6	Berkshire Hathaway - PacifiCorp	Sandra Shaffer		None	N/A
6	Black Hills Corporation	Eric Scherr		Affirmative	N/A
6	Bonneville Power Administration	Andrew Meyers		Affirmative	N/A
6	Cleco Corporation	Robert Hirschak	Louis Guidry	Affirmative	N/A
6	Con Ed - Consolidated Edison Co. of New York	Christopher Overberg		Affirmative	N/A
6	Dominion - Dominion Resources, Inc.	Sean Bodkin		Negative	Comments Submitted
6	Duke Energy	Greg Cecil		None	N/A
6	Edison International - Southern California Edison Company	Kenya Streeter		Negative	Comments Submitted
6	Exelon	Becky Webb		Abstain	N/A
6	FirstEnergy - FirstEnergy Solutions	Ann Carey		None	N/A
6	Florida Municipal Power Agency	Richard Montgomery	Brandon McCormick	Affirmative	N/A
6	Florida Municipal Power Agency	Tom Reedy	Brandon McCormick	Affirmative	N/A

Segment	Organization	Voter	Designated Proxy	Ballot	NERC Memo
6	Great Plains Energy - Kansas City Power and Light Co.	Jennifer Flandermeyer		Negative	Comments Submitted
6	Great River Energy	Donna Stephenson	Michael Brytowski	Negative	Comments Submitted
6	Lakeland Electric	Paul Shipps		Affirmative	N/A
6	Lincoln Electric System	Eric Ruskamp		Abstain	N/A
6	Los Angeles Department of Water and Power	Anton Vu		Affirmative	N/A
6	Manitoba Hydro	Blair Mukanik		Affirmative	N/A
6	MGE Energy - Madison Gas and Electric Co.	Robert Thorson		None	N/A
6	Muscatine Power and Water	Ryan Streck		Negative	Comments Submitted
6	New York Power Authority	Thomas Savin		Negative	Comments Submitted
6	NextEra Energy - Florida Power and Light Co.	Silvia Mitchell		Negative	Comments Submitted
6	NiSource - Northern Indiana Public Service Co.	Joe O'Brien		Affirmative	N/A
6	Northern California Power Agency	Dennis Sismaet		Abstain	N/A
6	OGE Energy - Oklahoma Gas and Electric Co.	Sing Tay		Negative	Comments Submitted
6	Portland General Electric Co.	Daniel Mason		Affirmative	N/A
6	Powerex Corporation	Gordon Dobson-Mack		None	N/A
6	PPL - Louisville Gas and Electric Co.	Linn Oelker		None	N/A
6	PSEG - PSEG Energy Resources and Trade LLC	Luiggi Beretta		Abstain	N/A
6	Public Utility District No. 1 of Cochise County	Davis Jelusich		Affirmative	N/A

Segment	Organization	Voter	Designated Proxy	Ballot	NERC Memo
6	Public Utility District No. 2 of Grant County, Washington	LeRoy Patterson		None	N/A
6	Sacramento Municipal Utility District	Jamie Cutlip	Joe Tarantino	Affirmative	N/A
6	Santee Cooper	Michael Brown		Affirmative	N/A
6	Seattle City Light	Charles Freeman		Negative	Comments Submitted
6	Seminole Electric Cooperative, Inc.	Trudy Novak		Abstain	N/A
6	Snohomish County PUD No. 1	Franklin Lu		Affirmative	N/A
6	Southern Company - Southern Company Generation	Ron Carlsen		Negative	Comments Submitted
6	Tacoma Public Utilities (Tacoma, WA)	Rick Applegate		Affirmative	N/A
6	Talen Energy Marketing, LLC	Jennifer Hohenshilt		Negative	Comments Submitted
6	Tennessee Valley Authority	Marjorie Parsons		Abstain	N/A
6	WEC Energy Group, Inc.	David Hathaway		Negative	Comments Submitted
6	Westar Energy	Grant Wilkerson	Douglas Webb	Negative	Comments Submitted
8	David Kiguel	David Kiguel		Abstain	N/A
9	Commonwealth of Massachusetts Department of Public Utilities	Donald Nelson		Affirmative	N/A
10	Midwest Reliability Organization	Russel Mountjoy		Abstain	N/A
10	New York State Reliability Council	ALAN ADAMSON		Abstain	N/A
10	Northeast Power Coordinating Council	Guy V. Zito		Abstain	N/A

© 2020 - NERC Ver 4.3.0.0 Machine Name: ERODVBSWB02

Segment	Organization	Voter	Designated Proxy	Ballot	NERC Memo
10	ReliabilityFirst	Anthony Jablonski		Affirmative	N/A
10	SERC Reliability Corporation	Dave Krueger		None	N/A
10	Western Electricity Coordinating Council	Steven Rueckert		Abstain	N/A

Showing 1 to 284 of 284 entries

Previous 1 Next

Standards Announcement

Project 2018-04 Modifications to PRC-024-2

45-day Formal Comment Period Open through May 31, 2019
Ballot Pools Forming through May 16, 2019

[Now Available](#)

A 45-day comment period for **PRC-024-3 – Generator Frequency and Voltage Protection Settings** is open until **8 p.m. Eastern, Friday, May 31, 2019**.

The standard drafting team is holding an [Industry Webinar](#) **1:00 to 2:00 p.m. Eastern, Tuesday, April 30, 2019** to review the modifications in proposed PRC-024-3.

Commenting

Use the [Standards Balloting and Commenting System \(SBS\)](#) to submit comments. If you experience issues using the SBS, contact [Wendy Muller](#). An unofficial Word version of the comment form is posted on the [project page](#).

Ballot Pools

Ballot pools are being formed through **8 p.m. Eastern, Thursday, May 16, 2019**. Registered Ballot Body members can join the ballot pools [here](#).

- *If you are having difficulty accessing the SBS due to a forgotten password, incorrect credential error messages, or system lock-out, contact NERC IT support directly at <https://support.nerc.net/> (Monday – Friday, 8 a.m. - 5 p.m. Eastern).*
- *Passwords expire every **6 months** and must be reset.*
- *The SBS is **not** supported for use on mobile devices.*
- *Please be mindful of ballot and comment period closing dates. We ask to **allow at least 48 hours** for NERC support staff to assist with inquiries. Therefore, it is recommended that users try logging into their SBS accounts **prior to the last day** of a comment/ballot period.*

Next Steps

A 10-day initial ballot for the standard and a non-binding poll of the associated Violation Risk Factors and Violation Severity Levels, will be conducted **May 22-31, 2019**.

For information on the Standards Development Process, refer to the [Standard Processes Manual](#).

For more information or assistance, contact Standards Developer, [Mat Bunch](#) (via email) or at (404) 446-9785.

North American Electric Reliability Corporation
3353 Peachtree Rd, NE
Suite 600, North Tower
Atlanta, GA 30326
404-446-2560 | www.nerc.com

Comment Report

Project Name: Project 2018-04 Modifications to PRC-024-2 | PRC-024-3 (Draft 1)
Comment Period Start Date: 4/17/2019
Comment Period End Date: 5/31/2019
Associated Ballots: 2018-04 Modifications to PRC-024-2 PRC-024-3 IN 1 ST

There were 69 sets of responses, including comments from approximately 169 different people from approximately 125 companies representing 10 of the Industry Segments as shown in the table on the following pages.

Questions

1. The standards drafting team (SDT) replaced “protective relays” to “protection” throughout the standard to include relays, settings in applicable control systems, as well as other types of voltage and frequency protection devices. Do you agree with these modifications? If you do not agree, or if you agree but have comments or suggestions, provide your recommendation, explanation, and proposed modification
2. To address confusion regarding “at the point of interconnection,” the team replaced it with the phrase, “at the high side of the generator step-up or collector transformer.” Do you agree with this clarifying change? If not, please provide an alternative suggestion
3. The SDT modified Requirements R1 and R2 to not allow momentary cessation, in addition to tripping, in the “no trip zone.” Do you agree that momentary cessation should not be allowed in the no trip zone? If not, please provide your rationale
4. Do you agree that “momentary cessation” – like “tripping” – is well understood by industry? If not, please provide your rationale
5. The SDT was apprised that, in some instances, the TO may own the GSU or collector transformers. As such, TOs were added to the applicable entity for cases where they may own a GSU or collector transformers with frequency and voltage protection enabled. Do you agree with the addition of TOs who own a GSU or collector transformer to the applicable entities? If not, please provide your rationale
6. Another intent of the facilities section was to clarify that voltage and frequency protection applied to plant auxiliary equipment is not applicable to the standard. Do you agree it is clear that plant aux equipment is out of scope of PRC-024? If not, please provide your rationale and a proposal
7. The SDT made several clarifying changes to the figures and tables (outlined in the SAR) to improve readability and eliminate confusion addressed in the SAR, including: (i) labeling the area outside the “No Trip Zone” as the “May Trip Zone;” (ii) removal of “ride-through” language; (iii) addition of “Minimum Time;” (iv) replacement of “instantaneous” with “0.10” seconds; and (v) clarifying modifications to the Voltage Boundary Clarifications. Do you agree with these modifications? If not, please recommend alternative solution(s)
8. The SDT added Quebec Interconnection-wide Variance to Requirement R2 with more stringent voltage boundaries for the No Trip Zone. Do you agree with this proposed Quebec Variance? If not, please provide your rationale
9. Do you agree with the proposed Implementation Plan? If not, please provide your rationale
10. Do you agree that the proposed modifications provide a cost-effective means of addressing issues in the SAR? If not, please provide an alternative, more cost-effective manner in which to achieve at least an equivalent level of reliability
11. If you have any additional comments on themes that have NOT already been addressed in the proceeding questions on this comment form, please provide them here

Organization Name	Name	Segment(s)	Region	Group Name	Group Member Name	Group Member Organization	Group Member Segment(s)	Group Member Region
Brandon McCormick	Brandon McCormick		FRCC	FMPA	Tim Beyrle	City of New Smyrna Beach Utilities Commission	4	FRCC
					Jim Howard	Lakeland Electric	5	FRCC
					Javier Cisneros	Fort Pierce Utilities Authority	3	FRCC
					Randy Hahn	Ocala Utility Services	3	FRCC
					Don Cuevas	Beaches Energy Services	1	FRCC
					Nick Batty	Keys Energy	4	FRCC
					Tom Reedy	Florida Municipal Power Pool	6	FRCC
					Steven Lancaster	Beaches Energy Services	3	FRCC
					Chris Adkins	City of Leesburg	3	FRCC
					Ginny Beigel	City of Vero Beach	3	FRCC
Southwest Power Pool, Inc. (RTO)	Charles Yeung	2	SPP RE	SRC	Helen Lainis	IESO	2	NPCC
					Greg Campoli	NYISO	2	NPCC
					Lori Spence	MISO	2	MRO
					Mark Holman	PJM	2	RF
					Matt Goldberg	ISONE	1	NPCC
					Ali Miremadi	CAISO	1	WECC
					Nathan Bigbee	ERCOT	1	Texas RE
Santee Cooper	Chris Wagner	1		Santee Cooper	Deborah Schneider	Santee Cooper	1,3,5,6	SERC
					Bridget Coffman	Santee Cooper	1,3,5,6	SERC

					Wesley Brickle	Santee Cooper	1,3,5,6	SERC
					Paul Camilletti	Santee Cooper	1,3,5,6	SERC
MRO	Dana Klem	1,2,3,4,5,6	MRO	MRO NSRF	Joseph DePoorter	Madison Gas & Electric	3,4,5,6	MRO
					Larry Heckert	Alliant Energy	4	MRO
					Amy Casucelli	Xcel Energy	1,3,5,6	MRO
					Michael Brytowski	Great River Energy	1,3,5,6	MRO
					Jodi Jensen	Western Area Power Administration	1,6	MRO
					Kayleigh Wilkerson	Lincoln Electric System	1,3,5,6	MRO
					Mahmood Safi	Omaha Public Power District	1,3,5,6	MRO
					Brad Parret	Minnesota Power	1,5	MRO
					Terry Harbour	MidAmerican Energy Company	1,3	MRO
					Tom Breene	Wisconsin Public Service Corporation	3,5,6	MRO
					Jeremy Voll	Basin Electric Power Cooperative	1	MRO
					Kevin Lyons	Central Iowa Power Cooperative	1	MRO
					Mike Morrow	Midcontinent ISO	2	MRO
Douglas Webb	Douglas Webb		MRO,SPP RE	Westar-KCPL	Doug Webb	Westar	1,3,5,6	MRO
					Doug Webb	KCP&L	1,3,5,6	MRO
ACES Power Marketing	Jodirah Green	1,3,4,5,6	MRO,NA - Not Applicable,RF,SERC,Texas RE,WECC	ACES Standard Collaborations	Bob Solomon	Hoosier Energy Rural Electric Cooperative, Inc.	1	SERC
					Kevin Lyons	Central Iowa Power Cooperative	1	MRO

					Ginger Mercier	Prairie Power , Inc.	1,3	SERC
					Susan Sosbe	Wabash Valley Power Association	3	SERC
					John Shaver	Arizona Electric Power Cooperative, Inc.	1	WECC
					Bill Hutchison	Southern Illinois Power Cooperative	1	SERC
DTE Energy - Detroit Edison Company	Karie Barczak	3		DTE Energy - DTE Electric	Jeffrey Depriest	DTE Energy - DTE Electric	5	RF
					Daniel Herring	DTE Energy - DTE Electric	4	RF
					Karie Barczak	DTE Energy - DTE Electric	3	RF
Lincoln Electric System	Kayleigh Wilkerson	5		Lincoln Electric System	Kayleigh Wilkerson	Lincoln Electric System	5	MRO
					Eric Ruskamp	Lincoln Electric System	6	MRO
					Jason Fortik	Lincoln Electric System	3	MRO
					Danny Pudenz	Lincoln Electric System	1	MRO
Duke Energy	Kim Thomas	1,3,5,6	FRCC,RF,SERC	Duke Energy	Laura Lee	Duke Energy	1	SERC
					Lee Schuster	Duke Energy	3	FRCC
					Dale Goodwine	Duke Energy	5	SERC
					Greg Cecil	Duke Energy	6	RF
Southern Company - Southern Company Services, Inc.	Pamela Hunter	1,3,5,6	SERC	Southern Company	Katherine Prewitt	Southern Company Services, Inc.	1	SERC
					Joel Dembowski	Southern Company - Alabama Power Company	3	SERC

					William D. Shultz	Southern Company Generation	5	SERC
					Jennifer G. Sykes	Southern Company Generation and Energy Marketing	6	SERC
Northeast Power Coordinating Council	Ruida Shu	1,2,3,4,5,6,7,8,9,10	NPCC	RSC no Dominion and Con Ed	Guy V. Zito	Northeast Power Coordinating Council	10	NPCC
					Randy MacDonald	New Brunswick Power	2	NPCC
					Glen Smith	Entergy Services	4	NPCC
					Brian Robinson	Utility Services	5	NPCC
					Alan Adamson	New York State Reliability Council	7	NPCC
					David Burke	Orange & Rockland Utilities	3	NPCC
					Michele Tondalo	UI	1	NPCC
					Helen Lainis	IESO	2	NPCC
					Michael Jones	National Grid	3	NPCC
					Sean Cavote	PSEG	4	NPCC
					Kathleen Goodman	ISO-NE	2	NPCC
					David Kiguel	Independent	NA - Not Applicable	NPCC
					Silvia Mitchell	NextEra Energy - Florida Power and Light Co.	6	NPCC
					Paul Malozewski	Hydro One Networks, Inc.	3	NPCC
					Gregory Campoli	New York Independent	2	NPCC

						System Operator			
						Caroline Dupuis	Hydro Quebec	1	NPCC
						Chantal Mazza	Hydro Quebec	2	NPCC
						Laura McLeod	NB Power Corporation	5	NPCC
						Nick Kowalczyk	Orange and Rockland	1	NPCC
						John Hastings	National Grid	1	NPCC
						Joel Charlebois	AESI - Acumen Engineered Solutions International Inc.	5	NPCC
						Quintin Lee	Eversource Energy	1	NPCC
						Mike Cooke	Ontario Power Generation, Inc.	4	NPCC
						Salvatore Spagnolo	New York Power Authority	1	NPCC
						Shivaz Chopra	New York Power Authority	5	NPCC
Dominion - Dominion Resources, Inc.	Sean Bodkin	6		Dominion	Connie Lowe	Dominion - Dominion Resources, Inc.		3	NA - Not Applicable
					Lou Oberski	Dominion - Dominion Resources, Inc.		5	NA - Not Applicable
					Larry Nash	Dominion - Dominion Virginia Power		1	NA - Not Applicable
Associated Electric Cooperative, Inc.	Todd Bennett	3		AECI	Michael Bax	Central Electric Power Cooperative (Missouri)		1	SERC
					Adam Weber	Central Electric Power		3	SERC

	Cooperative (Missouri)		
Stephen Pogue	M and A Electric Power Cooperative	3	SERC
William Price	M and A Electric Power Cooperative	1	SERC
Jeff Neas	Sho-Me Power Electric Cooperative	3	SERC
Peter Dawson	Sho-Me Power Electric Cooperative	1	SERC
Mark Ramsey	N.W. Electric Power Cooperative, Inc.	1	NPCC
John Stickley	NW Electric Power Cooperative, Inc.	3	SERC
Tony Gott	KAMO Electric Cooperative	3	SERC
Micah Breedlove	KAMO Electric Cooperative	1	SERC
Kevin White	Northeast Missouri Electric Power Cooperative	1	SERC
Skyler Wiegmann	Northeast Missouri Electric Power Cooperative	3	SERC
Ryan Ziegler	Associated Electric Cooperative, Inc.	1	SERC
Brian Ackermann	Associated Electric Cooperative, Inc.	6	SERC
Brad Haralson	Associated Electric	5	SERC

						Cooperative, Inc.		
--	--	--	--	--	--	----------------------	--	--

1. The standards drafting team (SDT) replaced “protective relays” to “protection” throughout the standard to include relays, settings in applicable control systems, as well as other types of voltage and frequency protection devices. Do you agree with these modifications? If you do not agree, or if you agree but have comments or suggestions, provide your recommendation, explanation, and proposed modification

Matthew McMillan - Talen Generation, LLC - 5

Answer No

Document Name

Comment

We do not agree with replacing “protective relays” with “protection,” since it puts mechanical protection in-scope. NERC stated in their 4/30/2019 webinar that this is not the intent of the SDT, but there is no such restriction in PRC-024-3 as presently worded, and it in fact says the opposite. That is, there is a PRC-024-3 violation if a unit trips due to disturbance within the no-trip zone, regardless of reason – could be an under-frequency relay (correct), furnace main flame trip (incorrect), V/Hz relay (correct), motor control center contactor drop-out (incorrect), or any other reason. The original term should be retained. See also our response to question 11 below.

Likes 0

Dislikes 0

Response

Jennifer Hohenshilt - Talen Energy Marketing, LLC - 6

Answer No

Document Name

Comment

We do not agree with replacing "protective relays" with "protection," since it puts mechanical protection in-scope. NERC stated in their 4/30/2019 webinar that this is not the intent of the SDT, but their is no such restriction in PRC-024-3 as presently worded, and it in fact says the opposite. That is, there is a PRC-024-3 violation if a unit trips due to disturbance within the no-trip zone, regardless of reason - could be an under-frequency relay (correct), furnace main flame trip (incorrect), V/Hz relay (correct), motor control center contractor drop-out (incorrect), or any other reason. The original term should be retained. See also our response to question 11 below.

Likes 0

Dislikes 0

Response

Glen Farmer - Avista - Avista Corporation - 5

Answer No

Document Name

Comment

Agree with EEI.

Likes 0

Dislikes 0

Response

Sean Bodkin - Dominion - Dominion Resources, Inc. - 6, Group Name Dominion

Answer No

Document Name

Comment

Dominion Energy recognizes the need to move away from the term “protective relay” used in the currently enforceable version of PRC-024; however, the use of the proposed term “protection” may be too broad to ensure that all applicable entities and industry stakeholders have a common understanding of what is included or required to ensure entity compliance with the proposed Reliability Standard PRC-024-3 Dominion Energy suggests the SDT either develop a proposed definition for the term “protection” or add additional language within the standard to provide context for the meaning of the term.

When the SDT either defines the term or adds additional context within the standard, Dominion Energy recommends that the SDT does not create a conflict with the existing Protection System definition.

Likes 1

SCANA - South Carolina Electric and Gas Co., 1,3,5,6, Shumpert RoLynda

Dislikes 0

Response

Dennis Chastain - Tennessee Valley Authority - 1,3,5,6 - SERC

Answer No

Document Name

Comment

“Protective relays” is an easily understood item and technical term. “Protection” can be interpreted more broadly and easily misconstrued. If the drafting team’s intention is to expand the applicability to include control systems on inverter based generation, then just add them to the scope and requirements and leave the protective relay terminology alone for non-inverter based generation.

Likes 0

Dislikes 0

Response

Kayleigh Wilkerson - Lincoln Electric System - 5, Group Name Lincoln Electric System

Answer No

Document Name

Comment

LES recommends the following change to applicability section 4.2.1 to improve clarity: "Frequency, voltage or volts-per-hertz protection, including frequency or voltage protective functions within **inverter-based** control systems that provide tripping or momentary cessation signals..."

Likes 0

Dislikes 0

Response

Dana Klem - MRO - 1,2,3,4,5,6 - MRO, Group Name MRO NSRF

Answer No

Document Name

Comment

The NSRF believe using the non-capitalized "protection" isn't sufficiently bounded. The drafting team needs to qualify protection with "protection systems that respond to electrical signals and directly trip the generating resource.

Without these qualifications, the entire generating resource including auxiliary equipment is open to interpretation. If a variable frequency drive trips a boiler feed pump on a voltage transient that subsequently trips the plant itself, that should not be the intent. Many plants are large and complicated, so indirect trips should not be in scope.

If the scope isn't contained, regulators after reviewing GADS reporting could ask if auxiliary systems were mapped to the high side GSU point of interconnection.

Likes 0

Dislikes 0

Response

Scott Berry - Scott Berry On Behalf of: Jack Alvey, Indiana Municipal Power Agency, 1, 4; - Scott Berry

Answer No

Document Name

Comment

In the attempt of the SDT to just add solar control systems to the standard, they may have also added control systems for non-solar generating units. For instance, gas turbines have turbine controls and exciter controls that may not consistently react to frequency and voltage excursions. For

example, a combustion turbine governor system (fuel control) may try to chase the over and under event which may lead to combustion cans losing flame and eventually a temperature differential trip. This type of event happen in southern Florida when the first version of PRC-024 happend and was reviewed by the SDT at that time. These control systems may trip off generating units in the "no trip" zone which would be a violation in the current draft of PRC-024-3. In most other conventional units, the exciter and turbine controls may be susceptible to tripping of the generator during voltage and frequency excursions. If these type of system controls are to be exempt, it is not clear in the draft that they are exempt. These type of systems should not be covered under the standard and if the standard wants to just add solar inverters to the standard that the SDT should use those exact words under the applicable Facilities section. The current wording under Facilities section 4.2.1 is too vague.

Likes 0

Dislikes 0

Response

Don Schmit - Nebraska Public Power District - 1,3,5

Answer

No

Document Name

Comment

NPPD supports the comments submitted by the MRO NSRF.

Likes 0

Dislikes 0

Response

Kim Thomas - Duke Energy - 1,3,5,6 - FRCC,SERC,RF, Group Name Duke Energy

Answer

No

Document Name

Comment

The standard's language needs to be more generic. Various IBR control systems and protection systems design features (not just "protection") have demonstrated the ability to cause curtailment of output for perturbations of frequency and voltage. The standard needs to require that none of these design features can cause IBR facilities to curtail output for frequency and voltage deviations within the limits specified in this standard.

Likes 0

Dislikes 0

Response

Jeremy Voll - Basin Electric Power Cooperative - 1,3,5,6

Answer

No

Document Name	
Comment	
Support the MRO NSRF Comments	
Likes 0	
Dislikes 0	
Response	
RoLynda Shumpert - SCANA - South Carolina Electric and Gas Co. - 1,3,5,6 - SERC	
Answer	No
Document Name	
Comment	
SCANA- South Carolina Electric and Gas (Dominion Energy South Carolina) is in agreement with comments form Sean Bodkin (Dominion Energy).	
Likes 0	
Dislikes 0	
Response	
Tom Hanzlik - SCANA - South Carolina Electric and Gas Co. - 1	
Answer	No
Document Name	
Comment	
I agree with the comments submitted by Sean Bodkin-Dominion	
Likes 0	
Dislikes 0	
Response	
Scott Parker - SCANA - South Carolina Electric and Gas Co. - 3	
Answer	No
Document Name	
Comment	

I am in agreement with comments submitted by Sean Bodkin-Dominion.

Likes 0

Dislikes 0

Response

Allen Schriver - NextEra Energy - 5

Answer

No

Document Name

Comment

Comments: This is a Protective Relay Standard which does not include control systems. While the SAR states, "*Clarify if the voltage and frequency protective functions within an inverter control system that trip the inverter are subject to the requirements of PRC-024*", it does not recommend inclusion of control systems. Control systems as designed by control engineers are to ensure required performance while operating within the equipment limits.

Also, based on events data to date, the inclusion of Volts/Hertz relaying on transformers has not been an issue and should not be written into the Standard.

Likes 0

Dislikes 0

Response

Pamela Hunter - Southern Company - Southern Company Services, Inc. - 1,3,5,6 - SERC, Group Name Southern Company

Answer

No

Document Name

Comment

The text "settings in applicable control systems" needs to be revised to "generator frequency and voltage protection settings in applicable control systems" so that not all of the settings within the control system are in the scope.

Likes 0

Dislikes 0

Response

Thomas Savin - New York Power Authority - 6

Answer

No

Document Name

Comment

The scope of “protection” should be defined within the standard regarding protective relay settings and settings in applicable control systems. If “other” types of voltage and frequency protection devices need to be included, then we suggest explaining the scope.

Likes 0

Dislikes 0

Response**Rachel Coyne - Texas Reliability Entity, Inc. - 10**

Answer

No

Document Name

Comment

Texas RE does not agree that using the term “protection” makes it clear that relays, settings in applicable control systems, as well as other types of voltage and frequency protection devices are included in the scope of the standard. Texas RE recommends using the term “protective function”.

Likes 0

Dislikes 0

Response**Alyssa Hubbard - SCANA - South Carolina Electric and Gas Co. - 5**

Answer

No

Document Name

Comment

I am in agreement with comments submitted by Sean Bodkin-Dominion.

Likes 0

Dislikes 0

Response**Jamie Monette - Allete - Minnesota Power, Inc. - 1**

Answer

No

Document Name

Comment

The term "protection" is very broad. The standard should include a footnote stating that "protection" is limited to devices which respond to electrical quantities and directly trip the generating resource.

Likes 0

Dislikes 0

Response

Douglas Webb - Douglas Webb On Behalf of: Allen Klassen, Westar Energy, 6, 3, 1, 5; Bryan Taggart, Westar Energy, 6, 3, 1, 5; Derek Brown, Westar Energy, 6, 3, 1, 5; Grant Wilkerson, Westar Energy, 6, 3, 1, 5; James McBee, Great Plains Energy - Kansas City Power and Light Co., 1, 3, 6, 5; Jennifer Flandermeyer, Great Plains Energy - Kansas City Power and Light Co., 1, 3, 6, 5; John Carlson, Great Plains Energy - Kansas City Power and Light Co., 1, 3, 6, 5; Marcus Moor, Great Plains Energy - Kansas City Power and Light Co., 1, 3, 6, 5; - Douglas Webb, Group Name Westar-KCPL

Answer

No

Document Name

Comment

Comments: Kansas City Power & Light Company and Westar endorses comments submitted by EEI member companies.

Likes 0

Dislikes 0

Response

Sandra Shaffer - Berkshire Hathaway - PacifiCorp - 6

Answer

No

Document Name

Comment

The NSRF believe using the non-capitalized "protection" isn't sufficiently bounded. The drafting team needs to qualify protection with "protection systems that respond to electrical signals and directly trip the generating resource.

Without these qualifications, the entire generating resource including auxiliary equipment is open to interpretation. If a variable frequency drive trips a boiler feed pump on a voltage transient that subsequently trips the plant itself, that should not be the intent. Many plants are large and complicated, so indirect trips should not be in scope.

If the scope isn't contained, regulators after reviewing GADS reporting could ask if auxiliary systems were mapped to the high side GSU point of interconnection.

Likes 0

Dislikes 0

Response

Bette White - AES - Indianapolis Power and Light Co. - 3

Answer

No

Document Name

Comment

IPL agrees with the direction the SDT is going but recommends adding a definitions section such as "Section 6 Definitions Used in This Standard" in PRC-005, to clearly define "protection", "control systems", "momentary cessation", etc. in PRC-024-3.

Likes 0

Dislikes 0

Response

Ruida Shu - Northeast Power Coordinating Council - 1,2,3,4,5,6,7,8,9,10 - NPCC, Group Name RSC no Dominion and Con Ed

Answer

No

Document Name

Comment

The scope of "protection" should be defined within the standard regarding protective relay settings and settings in applicable control systems. If "other" types of voltage and frequency protection devices need to be included, then we suggest explaining the scope.

Likes 0

Dislikes 0

Response

Leo Bernier - AES - AES Corporation - 5

Answer

No

Document Name

Comment

AES agrees with the direction the SDT is going but recommends adding a definitions section such as “Section 6 Definitions Used in This Standard” in PRC-005, to clearly define “protection”, “control systems”, “momentary cessation”, etc. in PRC-024-3.

Likes 0

Dislikes 0

Response

Mark Gray - Edison Electric Institute - NA - Not Applicable - NA - Not Applicable

Answer

No

Document Name

Comment

EI member companies recognize the need to move away from the term “protective relay” used in the currently enforceable version of PRC-024; however, the use of the proposed term “protection” may be too broad to ensure that all applicable entities have a common understanding of what is included or required to ensure entity compliance with the proposed Reliability Standard PRC-024-3. For example, entities may interpret the term to bring into scope mechanical protection issues and equipment that were not intended to be within the scope of this standard. For this reason, we suggest the SDT either develop a proposed definition for the term “protection” or add additional language within the standard to illustrate and clarify the term. To illustrate the type of definition that EEI member companies thinks is appropriate, we offer the following language for consideration:

Protection: Is a term used to describe a protective relay or functionally equivalent device (including multifunctional apparatus, computers or control systems) that provides the same functionality, as a traditional protective relay, when responding to various electrical quantities.

EEI member companies note that it has developed the above definition to ensure that it does not conflict with the existing Protection System definition and suggests that if the SDT decides to define protection, any similar potential for conflict should be avoided.

While EEI has not conducted an exhaustive assessment of where the term “protection” is used within the body of NERC Reliability Standards, we did find its use in the following Reliability Standards:

- Applicability section of most of the CIP Standards.
- FAC-010-3
- FAC-011-3
- PER-003-1
- PER-005-2 (Requirement R4 – protection system not capitalized)
- PRC-004-5(i)
- PRC-010-2
- PRC-015-1 (Within Purpose section – protection system not capitalized)
- PRC-017-1 (Within Purpose section – protection system not capitalized)
- PRC-019-2
- PRC-023-4
- PRC-024-2
- PRC-025-2
- TPL-001-4 (Table 1)

Likes 0

Dislikes 0

Response

Armin Klusman - CenterPoint Energy Houston Electric, LLC - 1 - Texas RE

Answer No

Document Name

Comment

CenterPoint Energy Houston Electric, LLC supports the comments submitted by the Edison Electric Institute.

Likes 0

Dislikes 0

Response

Charles Yeung - Southwest Power Pool, Inc. (RTO) - 2, Group Name SRC

Answer No

Document Name

Comment

While we basically agree with changing protective relays to protection, we also seek clarification for requirement 4.2.1.5 “*Elements utilized in aggregation of the dispersed power producing resources*” of what could be an “elements” for applicability of the PRC-024 requirements. Dispersed power resources which operate in aggregate utilize a controller which has the capability to automatically trip the resources under certain high-side system frequency and voltage conditions. The settings for these controllers should also be considered as being applicable to the PRC-024 requirements regardless of their ownership.

Likes 0

Dislikes 0

Response

Constantin Chitescu - Ontario Power Generation Inc. - 5

Answer No

Document Name

Comment

OPG supports RSC’s comments.

Likes 0

Dislikes 0

Response	
Bradley Collard - SunPower - 5	
Answer	No
Document Name	
Comment	
SunPower believes the term “protection” should be defined in the Glossary of Terms or provide more detail as to what “protection” means in relation to the Standard. Distinguishing between voltage and frequency inverter control protection settings and other protection settings would help clarify this issue. The Standard should not bring in other types of control systems, only those that could trip generation as a direct result of voltage and/or frequency.	
Likes 0	
Dislikes 0	
Response	
Faz Kasraie - Seattle City Light - 5	
Answer	No
Document Name	
Comment	
Likes 0	
Dislikes 0	
Response	
Thomas Foltz - AEP - 5	
Answer	Yes
Document Name	
Comment	
While AEP does not disagree with the concept of replacing “protective relays” with “protection”, more detail and clarity is still needed regarding the scope of control systems.	
Likes 0	
Dislikes 0	

Response

Aaron Cavanaugh - Bonneville Power Administration - 1,3,5,6 - WECC

Answer Yes

Document Name

Comment

None

Likes 0

Dislikes 0

Response

Michelle Amarantos - APS - Arizona Public Service Co. - 1

Answer Yes

Document Name

Comment

AZPS is concerned that the term “protection” is unclear and could potentially expand the included devices and equipment beyond the intent of the Standards Drafting Team (SDT). To ensure clarity and consistency in the application of this term, the SDT could draft a definition or otherwise revise the standard to address the potential ambiguity that could result from use of the term “protection” alone. Further, without additional clarification or a definition, “protection” could be construed broadly by both registered entities and regional entities resulting in inconsistent application of the term and the associated requirements. The inclusion of devices and equipment that were never intended to protect the transmission system from the effects of a generator in obligations and activities intended to meet compliance with PRC-024-3 could be unduly burdensome without benefit to reliability. Finally, AZPS recommends that the SDT review the remaining reliability standards to review other uses of the term “protection” as it evaluates the potential clarifications and/or definitions that could address the ambiguity discussed above.

Likes 0

Dislikes 0

Response

Chris Scanlon - Exelon - 1

Answer Yes

Document Name

Comment

Exelon, Segments 1, 3, 5, 6

Likes 0

Dislikes 0

Response

Scott Langston - Tallahassee Electric (City of Tallahassee, FL) - 1

Answer

Yes

Document Name

Comment

There should be a discussion as to what types of 'protection' that is known to be embedded in generator control systems. This will give those unfamiliar with how these embedded systems are typically setup (or known to be setup).

Likes 0

Dislikes 0

Response

Davis Jelusich - Public Utility District No. 1 of Chelan County - 6

Answer

Yes

Document Name

Comment

It seems the intention of NERC's Standard Authorization Request (SAR) and this change by the SDT is to clarify that protection functions within inverters are included within the scope of the Standard. However, based on the currently drafted language, this proposed change may also have the unintended effect of bringing other types of protections into the scope of this Standard. An example is the exciter protection of hydro generation units.

This potential additional interpretation does not appear to be the intent of the SDT nor warranted. Specific exclusions of protections not intended to be brought into the Standard seems warranted, specifically exciter protection functions.

Likes 0

Dislikes 0

Response

Karie Barczak - DTE Energy - Detroit Edison Company - 3, Group Name DTE Energy - DTE Electric

Answer

Yes

Document Name

Comment

Likes 0

Dislikes 0

Response

Maryanne Darling-Reich - Black Hills Corporation - 1,3,5,6 - MRO,WECC

Answer Yes

Document Name

Comment

Likes 0

Dislikes 0

Response

Leonard Kula - Independent Electricity System Operator - 2

Answer Yes

Document Name

Comment

Likes 0

Dislikes 0

Response

Jeanne Kurzynowski - CMS Energy - Consumers Energy Company - 1,3,4,5 - RF

Answer Yes

Document Name

Comment

Likes 0

Dislikes 0

Response

Chris Wagner - Santee Cooper - 1, Group Name Santee Cooper

Answer	Yes
Document Name	
Comment	
Likes 0	
Dislikes 0	
Response	
Eric Smith - NaturEner USA, LLC - 5	
Answer	Yes
Document Name	
Comment	
Likes 0	
Dislikes 0	
Response	
Amy Casuscelli - Amy Casuscelli On Behalf of: Gerry Huitt, Xcel Energy, Inc., 3, 1, 5; - Amy Casuscelli	
Answer	Yes
Document Name	
Comment	
Likes 0	
Dislikes 0	
Response	
Neil Swearingen - Salt River Project - 1,3,5,6 - WECC	
Answer	Yes
Document Name	
Comment	
Likes 0	

Dislikes 0

Response

Lana Smith - San Miguel Electric Cooperative, Inc. - 5

Answer

Yes

Document Name

Comment

Likes 0

Dislikes 0

Response

David Jendras - Ameren - Ameren Services - 3

Answer

Yes

Document Name

Comment

Likes 0

Dislikes 0

Response

Ozan Ferrin - Tacoma Public Utilities (Tacoma, WA) - 5

Answer

Yes

Document Name

Comment

Likes 0

Dislikes 0

Response

Steven Rueckert - Western Electricity Coordinating Council - 10

Answer

Yes

Document Name	
Comment	
Likes 0	
Dislikes 0	
Response	
Matthew Nutsch - Seattle City Light - 1,3,4,5,6 - WECC	
Answer	Yes
Document Name	
Comment	
Likes 0	
Dislikes 0	
Response	
Alex Chua - Pacific Gas and Electric Company - 1,3,5	
Answer	Yes
Document Name	
Comment	
Likes 0	
Dislikes 0	
Response	
Jesus Sammy Alcaraz - Imperial Irrigation District - 1	
Answer	Yes
Document Name	
Comment	
Likes 0	
Dislikes 0	

Response

Richard Jackson - U.S. Bureau of Reclamation - 1

Answer Yes

Document Name

Comment

Likes 0

Dislikes 0

Response

Andrew Gallo - Austin Energy - 1,3,4,5,6

Answer Yes

Document Name

Comment

Likes 0

Dislikes 0

Response

Shirley Mathew - Austin Energy - 5

Answer Yes

Document Name

Comment

Likes 1 Austin Energy, 3, Preston W. Dwayne

Dislikes 0

Response

Jodirah Green - ACES Power Marketing - 1,3,4,5,6 - MRO,WECC,Texas RE,SERC,RF, Group Name ACES Standard Collaborations

Answer Yes

Document Name

Comment

Likes 0

Dislikes 0

Response

Nick Batty - Keys Energy Services - NA - Not Applicable - FRCC

Answer

Yes

Document Name

Comment

Likes 0

Dislikes 0

Response

Anton Vu - Los Angeles Department of Water and Power - 6

Answer

Yes

Document Name

Comment

Likes 0

Dislikes 0

Response

Greg Davis - Georgia Transmission Corporation - 1

Answer

Yes

Document Name

Comment

Likes 0

Dislikes 0

Response

Brandon McCormick - Brandon McCormick On Behalf of: Carol Chinn, Florida Municipal Power Agency, 6, 4, 3, 5; Chris Gowder, Florida Municipal Power Agency, 6, 4, 3, 5; Darko Kovac, Gainesville Regional Utilities, 1, 5, 3; David Owens, Gainesville Regional Utilities, 1, 5, 3; Don Cuevas, Beaches Energy Services, 1, 3; Joe McKinney, Florida Municipal Power Agency, 6, 4, 3, 5; Neville Bowen, Ocala Utility Services, 3; Nick Batty, Keys Energy Services, 4; Richard Montgomery, Florida Municipal Power Agency, 6, 4, 3, 5; Steven Lancaster, Beaches Energy Services, 1, 3; Tom Reedy, Florida Municipal Power Pool, 6; - Brandon McCormick, Group Name FMPA

Answer Yes

Document Name

Comment

Likes 0

Dislikes 0

Response

Todd Bennett - Associated Electric Cooperative, Inc. - 3, Group Name AECI

Answer

Document Name

Comment

AECI supports the comments submitted by ACES

Likes 0

Dislikes 0

Response

Richard Vine - California ISO - 2

Answer

Document Name

Comment

The California ISO supports the comments as submitted by the ISO/RTO Council Standards Review Committee (SRC)

Likes 0

Dislikes 0

Response

Kagen DelRio - Kagen DelRio On Behalf of: doug white, North Carolina Electric Membership Corporation, 4, 3, 5; John Lemire, North Carolina Electric Membership Corporation, 4, 3, 5; Robert Beadle, North Carolina Electric Membership Corporation, 4, 3, 5; - Kagen DelRio

Answer

Document Name

Comment

NCEMC supports the comments submitted by ACES

Likes 0

Dislikes 0

Response

2. To address confusion regarding “at the point of interconnection,” the team replaced it with the phrase, “at the high side of the generator step-up or collector transformer.” Do you agree with this clarifying change? If not, please provide an alternative suggestion

Charles Yeung - Southwest Power Pool, Inc. (RTO) - 2, Group Name SRC

Answer No

Document Name

Comment

Utilizing “at the high side of the generator step-up or collector transformer” may introduce a planning gap between the location of the generator step-up (GSU) or collector transformer and the true point of interconnection since Transmission Planners utilize the point of interconnection for planning purposes. Miles of transmission line may exist between a GSU or collector transformer and a point of interconnection. Specifying the high side of the GSU or collector transformer could introduce reliability issues and/or change system requirements due to the planning gap. One potential solution to be considered is utilizing “Point of Receipt,” which is defined in the NERC Glossary as “[a] location that the Transmission Service Provider specifies on its transmission system where an Interchange Transaction enters or a Generator delivers its output.”

In addition, the SDT should consider the possibility that a GSU and collector transformer may both be present at a single generating Facility. [\[1\]](#)

[\[1\]](#) IESO and CAISO do not agree to this comment and are not considered as endorsing the SRC position for this response.

Likes 0

Dislikes 0

Response

Armin Klusman - CenterPoint Energy Houston Electric, LLC - 1 - Texas RE

Answer No

Document Name

Comment

CenterPoint Energy Houston Electric, LLC supports the comments submitted by the Edison Electric Institute.

Likes 0

Dislikes 0

Response

Mark Gray - Edison Electric Institute - NA - Not Applicable - NA - Not Applicable

Answer No

Document Name

Comment

While EEI member companies support the substantive improvements made by the SDT through the replacement of the phrase “at the point of interconnection,” with the phrase, “at the high side of the generator step-up or collector transformer,” we continue to have some concerns that these changes may not be sufficiently bounded. For example, the currently proposed language in Section 4.2.1.5 has the potential of expanding the scope of Inclusion 4 since no limits are provided. Therefore, as an alternative suggestion, we ask the SDT to consider the following language for section 4.2.1.5, which we believe both limits the scope and better aligns with Inclusion 4 of the BES Definition:

Elements designed primarily for the delivery of capacity from dispersed power producing resources. (or alternatively utilize the more simplified language provided in question 11)

Likes 0

Dislikes 0

Response

Sandra Shaffer - Berkshire Hathaway - PacifiCorp - 6

Answer No

Document Name

Comment

The NSRF does not agree with the addition of “collector transformer”, since we believe the SDT is referring to <100kV transformers (perhaps used in a collector system) which are out of scope per BES Definition I4. The SDT needs to quantify what transformers are within scope. The NSRF cannot support the use of the term “collector transformer”.

Likes 0

Dislikes 0

Response

Douglas Webb - Douglas Webb On Behalf of: Allen Klassen, Westar Energy, 6, 3, 1, 5; Bryan Taggart, Westar Energy, 6, 3, 1, 5; Derek Brown, Westar Energy, 6, 3, 1, 5; Grant Wilkerson, Westar Energy, 6, 3, 1, 5; James McBee, Great Plains Energy - Kansas City Power and Light Co., 1, 3, 6, 5; Jennifer Flandermeyer, Great Plains Energy - Kansas City Power and Light Co., 1, 3, 6, 5; John Carlson, Great Plains Energy - Kansas City Power and Light Co., 1, 3, 6, 5; Marcus Moor, Great Plains Energy - Kansas City Power and Light Co., 1, 3, 6, 5; - Douglas Webb, Group Name Westar-KCPL

Answer No

Document Name

Comment

Comments: Kansas City Power & Light Company and Westar endorses comments submitted by EEI member companies.

Likes 0

Dislikes 0

Response

Jamie Monette - Allete - Minnesota Power, Inc. - 1

Answer No

Document Name

Comment

An alternative is to use illustrations similar to those found in PRC-025-2 Table 1, page 37 & 38 to show exactly which facilities are being referred to.

Likes 0

Dislikes 0

Response

Pamela Hunter - Southern Company - Southern Company Services, Inc. - 1,3,5,6 - SERC, Group Name Southern Company

Answer No

Document Name

Comment

It is unclear if the generator step-up transformer is the inverter (the ac generator) step up transformer whose HV side is typically around 35kV, or if the generator step-up transformer is the main station transformer whose HV side is typically from 115kV to 345kV. It is also unclear if the "collector transformer" is the same as the main station transformer described in the previous sentence. If the intention is that the point of analysis can be either of the two transformers discussed, then the replaced phrase in the draft version of the standard is fine.

Likes 0

Dislikes 0

Response

Chris Scanlon - Exelon - 1

Answer No

Document Name

Comment

Exelon agrees that the Point of Interconnection may not always be the ideal location to apply the standard requirements, but it is however typically easy to identify. Sites may have multiple step-up or collector transformers. The proposed language while attempting to address confusion may create more uncertainty. As an alternative, Exelon suggests the team consider the following verbiage: "at the high side of the transformer that connects the aggregated generation resource to the transmission system."

Exelon, Segments 1, 3, 5, 6

Likes 0

Dislikes 0

Response

Jeremy Voll - Basin Electric Power Cooperative - 1,3,5,6

Answer

No

Document Name

Comment

Support the MRO NSRF Comments

Likes 0

Dislikes 0

Response

Don Schmit - Nebraska Public Power District - 1,3,5

Answer

No

Document Name

Comment

NPPD supports the comments submitted by the MRO NSRF.

Likes 0

Dislikes 0

Response

Scott Berry - Scott Berry On Behalf of: Jack Alvey, Indiana Municipal Power Agency, 1, 4; - Scott Berry

Answer

No

Document Name

Comment

Some generating units have significant miles of line that connect its step-up transformer to their point of interconnection with their Transmission Owner. Therefore, the point of interconnection would not be the high side of the generator step up side. In FAC-008-3, Generator Owners have to use point of interconnection with its Transmission Owner in Requirement R2. This point should be the same for PRC-024.

Likes 0

Dislikes 0

Response

Alex Chua - Pacific Gas and Electric Company - 1,3,5

Answer

No

Document Name

Comment

Flexibility should be allowed if the original studies were done at the point of interconnection: "at the point of interconnection or the high side of the generator step-up or collector transformer"

Likes 0

Dislikes 0

Response

Dana Klem - MRO - 1,2,3,4,5,6 - MRO, Group Name MRO NSRF

Answer

No

Document Name

Comment

The NSRF does not agree with the addition of "collector transformer", since we believe the SDT is referring to <100kV transformers (perhaps used in a collector system) which are out of scope per BES Definition I4. The SDT needs to quantify what transformers are within scope. The NSRF cannot support the use of the term "collector transformer".

Likes 0

Dislikes 0

Response

Michelle Amarantos - APS - Arizona Public Service Co. - 1

Answer

No

Document Name

Comment

AZPS suggests generator side terminal voltage be used instead of the high-side voltage. Using high-side GSU voltage unnecessarily creates confusion and calculation burden, when there has been no realistic case study or other justification presented that would support using the terminal voltage or that indicates that use of the generator side terminal voltage will not be adequate. In fact, due to AVR, AZPS respectfully asserts that use of the generator terminal voltage is steadier and more appropriate than use of the high-side voltage.

Likes 0

Dislikes 0

Response**Thomas Foltz - AEP - 5****Answer**

No

Document Name**Comment**

While AEP recognizes the SDT is attempting to provide clarification, it should be recognized that “Point of Interconnection” has been used within the standard since its implementation and also within interconnection service agreements. Making the suggested changes could lead to having multiple points of coordination within a facility, which would likely cause even more confusion. It is not always explicitly clear what the terms “generator step up” and “collector transformer” are referring to when referencing different sources of generation and projects involving multiple voltage step-ups or step-downs *prior* to the point of interconnection.

We do not believe it is the drafting team’s intent to change what has historically been understood as the reference point of compliance for existing generation, and urge the SDT to not disrupt what has been recognized as the reference point of compliance.

Likes 0

Dislikes 0

Response**Constantin Chitescu - Ontario Power Generation Inc. - 5****Answer**

Yes

Document Name**Comment**

OPG supports RSC’s comments.

Likes 0

Dislikes 0

Response

Ruida Shu - Northeast Power Coordinating Council - 1,2,3,4,5,6,7,8,9,10 - NPCC, Group Name RSC no Dominion and Con Ed

Answer Yes

Document Name

Comment

The Standard Drafting team should clarify which Transformer a GO should consider when they have multiple Step Up or Collector transformers on line (multiple stages of step up to reach Interconnecting voltage)

Likes 0

Dislikes 0

Response

Alyssa Hubbard - SCANA - South Carolina Electric and Gas Co. - 5

Answer Yes

Document Name

Comment

I am in agreement with comments submitted by Sean Bodkin-Dominion.

Likes 0

Dislikes 0

Response

Rachel Coyne - Texas Reliability Entity, Inc. - 10

Answer Yes

Document Name

Comment

Texas RE agrees this change provides clarity regarding previously incorrect usage of term "point of interconnection".

Likes 0

Dislikes 0

Response

Aaron Cavanaugh - Bonneville Power Administration - 1,3,5,6 - WECC

Answer	Yes
--------	-----

Document Name	
---------------	--

Comment	
---------	--

None

Likes	0
-------	---

Dislikes	0
----------	---

Response	
----------	--

Bradley Collard - SunPower - 5

Answer	Yes
--------	-----

Document Name	
---------------	--

Comment	
---------	--

Likes	0
-------	---

Dislikes	0
----------	---

Response	
----------	--

Leo Bernier - AES - AES Corporation - 5

Answer	Yes
--------	-----

Document Name	
---------------	--

Comment	
---------	--

Likes	0
-------	---

Dislikes	0
----------	---

Response	
----------	--

Bette White - AES - Indianapolis Power and Light Co. - 3

Answer	Yes
--------	-----

Document Name	
---------------	--

Comment	
---------	--

Likes 0

Dislikes 0

Response

Brandon McCormick - Brandon McCormick On Behalf of: Carol Chinn, Florida Municipal Power Agency, 6, 4, 3, 5; Chris Gowder, Florida Municipal Power Agency, 6, 4, 3, 5; Darko Kovac, Gainesville Regional Utilities, 1, 5, 3; David Owens, Gainesville Regional Utilities, 1, 5, 3; Don Cuevas, Beaches Energy Services, 1, 3; Joe McKinney, Florida Municipal Power Agency, 6, 4, 3, 5; Neville Bowen, Ocala Utility Services, 3; Nick Batty, Keys Energy Services, 4; Richard Montgomery, Florida Municipal Power Agency, 6, 4, 3, 5; Steven Lancaster, Beaches Energy Services, 1, 3; Tom Reedy, Florida Municipal Power Pool, 6; - Brandon McCormick, Group Name FMPA

Answer

Yes

Document Name

Comment

Likes 0

Dislikes 0

Response

Greg Davis - Georgia Transmission Corporation - 1

Answer

Yes

Document Name

Comment

Likes 0

Dislikes 0

Response

Anton Vu - Los Angeles Department of Water and Power - 6

Answer

Yes

Document Name

Comment

Likes 0

Dislikes 0

Response

Davis Jelusich - Public Utility District No. 1 of Chelan County - 6

Answer Yes

Document Name

Comment

Likes 0

Dislikes 0

Response

Nick Batty - Keys Energy Services - NA - Not Applicable - FRCC

Answer Yes

Document Name

Comment

Likes 0

Dislikes 0

Response

Thomas Savin - New York Power Authority - 6

Answer Yes

Document Name

Comment

Likes 0

Dislikes 0

Response

Jodirah Green - ACES Power Marketing - 1,3,4,5,6 - MRO,WECC,Texas RE,SERC,RF, Group Name ACES Standard Collaborations

Answer Yes

Document Name

Comment

Likes 0

Dislikes 0

Response**Scott Langston - Tallahassee Electric (City of Tallahassee, FL) - 1****Answer**

Yes

Document Name**Comment**

Likes 0

Dislikes 0

Response**Allen Schriver - NextEra Energy - 5****Answer**

Yes

Document Name**Comment**

Likes 0

Dislikes 0

Response**Scott Parker - SCANA - South Carolina Electric and Gas Co. - 3****Answer**

Yes

Document Name**Comment**

Likes 0

Dislikes 0

Response

Shirley Mathew - Austin Energy - 5

Answer Yes

Document Name

Comment

Likes 1 Austin Energy, 3, Preston W. Dwayne

Dislikes 0

Response

Andrew Gallo - Austin Energy - 1,3,4,5,6

Answer Yes

Document Name

Comment

Likes 0

Dislikes 0

Response

Richard Jackson - U.S. Bureau of Reclamation - 1

Answer Yes

Document Name

Comment

Likes 0

Dislikes 0

Response

Tom Hanzlik - SCANA - South Carolina Electric and Gas Co. - 1

Answer Yes

Document Name

Comment

Likes 0

Dislikes 0

Response

RoLynda Shumpert - SCANA - South Carolina Electric and Gas Co. - 1,3,5,6 - SERC

Answer

Yes

Document Name

Comment

Likes 0

Dislikes 0

Response

Jesus Sammy Alcaraz - Imperial Irrigation District - 1

Answer

Yes

Document Name

Comment

Likes 0

Dislikes 0

Response

Kim Thomas - Duke Energy - 1,3,5,6 - FRCC,SERC,RF, Group Name Duke Energy

Answer

Yes

Document Name

Comment

Likes 0

Dislikes 0

Response

Matthew Nutsch - Seattle City Light - 1,3,4,5,6 - WECC

Answer	Yes
---------------	-----

Document Name	
----------------------	--

Comment	
----------------	--

Likes	0
-------	---

Dislikes	0
----------	---

Response	
-----------------	--

Steven Rueckert - Western Electricity Coordinating Council - 10

Answer	Yes
---------------	-----

Document Name	
----------------------	--

Comment	
----------------	--

Likes	0
-------	---

Dislikes	0
----------	---

Response	
-----------------	--

Ozan Ferrin - Tacoma Public Utilities (Tacoma, WA) - 5

Answer	Yes
---------------	-----

Document Name	
----------------------	--

Comment	
----------------	--

Likes	0
-------	---

Dislikes	0
----------	---

Response	
-----------------	--

David Jendras - Ameren - Ameren Services - 3

Answer	Yes
---------------	-----

Document Name	
----------------------	--

Comment	
----------------	--

Likes 0

Dislikes 0

Response

Lana Smith - San Miguel Electric Cooperative, Inc. - 5

Answer

Yes

Document Name

Comment

Likes 0

Dislikes 0

Response

Neil Swearingen - Salt River Project - 1,3,5,6 - WECC

Answer

Yes

Document Name

Comment

Likes 0

Dislikes 0

Response

Kayleigh Wilkerson - Lincoln Electric System - 5, Group Name Lincoln Electric System

Answer

Yes

Document Name

Comment

Likes 0

Dislikes 0

Response

Amy Casuscelli - Amy Casuscelli On Behalf of: Gerry Huitt, Xcel Energy, Inc., 3, 1, 5; - Amy Casuscelli

Answer	Yes
Document Name	
Comment	
Likes 0	
Dislikes 0	
Response	
Eric Smith - NaturEner USA, LLC - 5	
Answer	Yes
Document Name	
Comment	
Likes 0	
Dislikes 0	
Response	
Dennis Chastain - Tennessee Valley Authority - 1,3,5,6 - SERC	
Answer	Yes
Document Name	
Comment	
Likes 0	
Dislikes 0	
Response	
Chris Wagner - Santee Cooper - 1, Group Name Santee Cooper	
Answer	Yes
Document Name	
Comment	
Likes 0	

Dislikes 0

Response

Sean Bodkin - Dominion - Dominion Resources, Inc. - 6, Group Name Dominion

Answer Yes

Document Name

Comment

Likes 1

SCANA - South Carolina Electric and Gas Co., 1,3,5,6, Shumpert RoLynda

Dislikes 0

Response

Glen Farmer - Avista - Avista Corporation - 5

Answer Yes

Document Name

Comment

Likes 0

Dislikes 0

Response

Jeanne Kurzynowski - CMS Energy - Consumers Energy Company - 1,3,4,5 - RF

Answer Yes

Document Name

Comment

Likes 0

Dislikes 0

Response

Leonard Kula - Independent Electricity System Operator - 2

Answer Yes

Document Name	
Comment	
Likes 0	
Dislikes 0	
Response	
Jennifer Hohenshilt - Talen Energy Marketing, LLC - 6	
Answer	Yes
Document Name	
Comment	
Likes 0	
Dislikes 0	
Response	
Matthew McMillan - Talen Generation, LLC - 5	
Answer	Yes
Document Name	
Comment	
Likes 0	
Dislikes 0	
Response	
Maryanne Darling-Reich - Black Hills Corporation - 1,3,5,6 - MRO,WECC	
Answer	Yes
Document Name	
Comment	
Likes 0	
Dislikes 0	

Response	
Karie Barczak - DTE Energy - Detroit Edison Company - 3, Group Name DTE Energy - DTE Electric	
Answer	Yes
Document Name	
Comment	
Likes	0
Dislikes	0

Response	
Kagen DelRio - Kagen DelRio On Behalf of: doug white, North Carolina Electric Membership Corporation, 4, 3, 5; John Lemire, North Carolina Electric Membership Corporation, 4, 3, 5; Robert Beadle, North Carolina Electric Membership Corporation, 4, 3, 5; - Kagen DelRio	
Answer	
Document Name	
Comment	
NCEMC supports the comments submitted by ACES	
Likes	0
Dislikes	0

Response	
Richard Vine - California ISO - 2	
Answer	
Document Name	
Comment	
The California ISO supports the comments as submitted by the ISO/RTO Council Standards Review Committee (SRC)	
Likes	0
Dislikes	0

Response	
Todd Bennett - Associated Electric Cooperative, Inc. - 3, Group Name AECI	

Answer	
Document Name	
Comment	
AECI supports the comments submitted by ACES	
Likes 0	
Dislikes 0	
Response	

3. The SDT modified Requirements R1 and R2 to not allow momentary cessation, in addition to tripping, in the “no trip zone.” Do you agree that momentary cessation should not be allowed in the no trip zone? If not, please provide your rationale

Glen Farmer - Avista - Avista Corporation - 5

Answer No

Document Name

Comment

Agree with EEI

Likes 0

Dislikes 0

Response

Sergey Kynev - Siemens - Siemens Energy, Inc. - NA - Not Applicable - NA - Not Applicable

Answer No

Document Name

Comment

An exception for FACTS/HVDC devices has to be made. Shunt connected FACTS devices, like STATCOM or SVC do not have any energy source behind the power electronics and require to block (momentary cessation) during close-in fault (e.g. voltage below 0.3pu). This is a technology limitation, which is well understood and accepted in the industry.

This topic has been already addressed by NERC in Reliability Guideline BPS-Connected Inverter-Based Resource Performance App.E

Likes 0

Dislikes 0

Response

Sean Bodkin - Dominion - Dominion Resources, Inc. - 6, Group Name Dominion

Answer No

Document Name

Comment

While Dominion Energy generally supports the concept that resources intended to support BES reliability should not enter into “momentary cessation” within the “no trip zone”; the terms should be defined before using them within Reliability Standards. The meaning of “momentary cessation” may not

be consistently understood among all stakeholders and different organization have defined the term differently, as outlined in our response to question #4 below.

Likes 1

SCANA - South Carolina Electric and Gas Co., 1,3,5,6, Shumpert RoLynda

Dislikes 0

Response

Michelle Amarantos - APS - Arizona Public Service Co. - 1

Answer

No

Document Name

Comment

AZPS submits that the term “momentary cessation” is unclear based on differing definitions circulated in industry and that, as discussed above, ambiguity could create confusion and inconsistency in the application of the term both by registered entities and regional entities. For this reason, AZPS respectfully supports and reiterates EEI’s comments and recommendations regarding definition of “momentary cessation.”

Likes 0

Dislikes 0

Response

Dana Klem - MRO - 1,2,3,4,5,6 - MRO, Group Name MRO NSRF

Answer

No

Document Name

Comment

This question is confusing as R1 and R2 do allow for tripping and or momentary cessation within the “no trip zone” with proper documentation. The NSRF believes the exception in R1 and R2 are needed for older equipment that cannot physically be changed to not trip, within the no trip zone.

Likes 0

Dislikes 0

Response

Don Schmit - Nebraska Public Power District - 1,3,5

Answer

No

Document Name

Comment

NPPD supports the comments submitted by the MRO NSRF.

Likes 0

Dislikes 0

Response

Jeremy Voll - Basin Electric Power Cooperative - 1,3,5,6

Answer

No

Document Name

Comment

Support the MRO NSRF Comments

Likes 0

Dislikes 0

Response

RoLynda Shumpert - SCANA - South Carolina Electric and Gas Co. - 1,3,5,6 - SERC

Answer

No

Document Name

Comment

SCANA- South Carolina Electric and Gas (Dominion Energy South Carolina) is in agreement with comments from Sean Bodkin (Dominion Energy).

Likes 0

Dislikes 0

Response

Tom Hanzlik - SCANA - South Carolina Electric and Gas Co. - 1

Answer

No

Document Name

Comment

I agree with the comments submitted by Sean Bodkin-Dominion

Likes 0

Dislikes 0

Response

Scott Parker - SCANA - South Carolina Electric and Gas Co. - 3

Answer

No

Document Name

Comment

I am in agreement with comments submitted by Sean Bodkin-Dominion.

Likes 0

Dislikes 0

Response

Allen Schriver - NextEra Energy - 5

Answer

No

Document Name

Comment

Comments: Inverters initiate momentary cessation due to voltages measured at their terminals. They initiate momentary cessation to protect the power electronics. The voltages seen at the terminals may be due to switching spikes on the low side of the GSU which may not be reflected in the voltage at the point of interconnection.

Likes 0

Dislikes 0

Response

Pamela Hunter - Southern Company - Southern Company Services, Inc. - 1,3,5,6 - SERC, Group Name Southern Company

Answer

No

Document Name

Comment

In equipment where the implementation of momentary cessation is a control system response to systems conditions for which the controllability of the power conversion is not feasible, which is not a generator protective relay or generator protection system setting, making it out of the scope of the purpose of the standard. Therefore, references to "entering momentary cessation" should not be part of this standard. Further, the first bullet under R1 and the fourth bullet of R2 in the current version of the standard (...*Generating unit(s) may trip if the protective functions (such as out-of-step functions*

or loss-of-field functions) operate due to an impending or actual loss of synchronism or, for asynchronous generating units, due to instability in power conversion control equipment....) should be retained rather than deleted because requiring a generating facility to not trip due to impending loss of synchronism, actual loss of synchronism, or due to instability in power conversion control equipment may exacerbate the system condition which originated the disturbance. That is, not allowing a unit to trip when it needs to trip in those instances can make the situation worse.

Likes 0

Dislikes 0

Response

Alyssa Hubbard - SCANA - South Carolina Electric and Gas Co. - 5

Answer No

Document Name

Comment

I am in agreement with comments submitted by Sean Bodkin-Dominion.

Likes 0

Dislikes 0

Response

Jamie Monette - Allete - Minnesota Power, Inc. - 1

Answer No

Document Name

Comment

This question is confusing because it does not address the exceptions in R1 and R2. Minnesota Power agrees that momentary cessation should not be allowed in the no trip zone, except where the standard allows for exceptions.

Likes 0

Dislikes 0

Response

Douglas Webb - Douglas Webb On Behalf of: Allen Klassen, Westar Energy, 6, 3, 1, 5; Bryan Taggart, Westar Energy, 6, 3, 1, 5; Derek Brown, Westar Energy, 6, 3, 1, 5; Grant Wilkerson, Westar Energy, 6, 3, 1, 5; James McBee, Great Plains Energy - Kansas City Power and Light Co., 1, 3, 6, 5; Jennifer Flandermeyer, Great Plains Energy - Kansas City Power and Light Co., 1, 3, 6, 5; John Carlson, Great Plains Energy - Kansas City Power and Light Co., 1, 3, 6, 5; Marcus Moor, Great Plains Energy - Kansas City Power and Light Co., 1, 3, 6, 5; - Douglas Webb, Group Name Westar-KCPL

Answer No

Document Name	
Comment	
Comments: Kansas City Power & Light Company and Westar endorses comments submitted by EEI member companies.	
Likes 0	
Dislikes 0	
Response	
Sandra Shaffer - Berkshire Hathaway - PacifiCorp - 6	
Answer	No
Document Name	
Comment	
This question is confusing as R1 and R2 do allow for tripping and or momentary cessation within the “no trip zone” with proper documentation. The NSRF believes the exception in R1 and R2 are needed for older equipment that cannot physically be changed to not trip, within the no trip zone.	
Likes 0	
Dislikes 0	
Response	
Mark Gray - Edison Electric Institute - NA - Not Applicable - NA - Not Applicable	
Answer	No
Document Name	
Comment	
EEI member companies generally agree that resources intended to support BES reliability should not enter into “momentary cessation” within the “no trip zone”; however, we believe that the industry must first define the term “momentary cessation” before applying it within Reliability Standards. For this reason, we cannot support its use at this time.	
Likes 0	
Dislikes 0	
Response	
Armin Klusman - CenterPoint Energy Houston Electric, LLC - 1 - Texas RE	
Answer	No

Document Name

Comment

CenterPoint Energy Houston Electric, LLC supports the comments submitted by the Edison Electric Institute.

Likes 0

Dislikes 0

Response

Bradley Collard - SunPower - 5

Answer

No

Document Name

Comment

The question as asked is misleading. SunPower does not feel momentary cessation should be allowed except where it is infeasible to not allow due to equipment technical exceptions as allowed in R1 and R2.

Likes 0

Dislikes 0

Response

Aaron Cavanaugh - Bonneville Power Administration - 1,3,5,6 - WECC

Answer

Yes

Document Name

Comment

None

Likes 0

Dislikes 0

Response

Jeanne Kurzynowski - CMS Energy - Consumers Energy Company - 1,3,4,5 - RF

Answer

Yes

Document Name

Comment

Assuming this question is not contradicting the Requirement R2 exceptions.

Likes 0

Dislikes 0

Response

Matthew Nutsch - Seattle City Light - 1,3,4,5,6 - WECC

Answer

Yes

Document Name

Comment

Likes 0

Dislikes 0

Response

Chris Scanlon - Exelon - 1

Answer

Yes

Document Name

Comment

Exelon interprets momentary cessation as equivalent to a trip and automatic reclose, and agree momentary cessation should not be allowed in the no trip zone.

Exelon, Segments 1, 3, 5, 6

Likes 0

Dislikes 0

Response

Scott Langston - Tallahassee Electric (City of Tallahassee, FL) - 1

Answer

Yes

Document Name

Comment

However, momentary cessation should be defined in the standard, so that the term is clearly understood.

Likes 0

Dislikes 0

Response

Michael Goggin - Grid Strategies - 5 - NA - Not Applicable

Answer

Yes

Document Name

Comment

I generally support the draft standard and believe its requirements are reasonable and achievable for newly installed inverters on a going-forward basis. However, I am concerned that the draft standard does not provide a workable means of compliance for the small share of the existing inverter fleet that cannot readily be updated to eliminate momentary cessation and meet the protection setting requirements in R1 and R2. NERC and others have determined that there is *de minimus* reliability risk from existing inverters that are unable to eliminate momentary cessation, so we strongly advise against imposing a costly retrofit or replacement requirement on those inverters that would not provide any measurable reliability benefit.

Specifically, footnote 5 in Requirement R3 on page 4 clarifies that the permissible exemption from the protection setting requirements in R1 and R2, due to a “known regulatory or equipment limitation,” “Excludes limitations that are caused by the setting capability of the generator frequency and voltage protection itself but does not exclude limitations originating in the equipment that it protects.” This footnote seems to deny the R3 equipment limitation exemption for inverters for which “the setting capability of the generator frequency and voltage protection itself” limits its ability to comply with R1 and R2. Our concern is that this would bar an existing inverter that cannot be updated to eliminate momentary cessation from using the R3 exemption. While we believe this requirement is reasonable for newly installed inverters on a going-forward basis, we do not believe it is a reasonable requirement for existing inverters that cannot be updated to eliminate momentary cessation, as it would likely require their replacement, or at least a costly retrofit.

Data collected through the NERC guideline indicates that of 13.5 GW of existing Bulk Power System solar resources that responded to the survey, only 1.8 GW were unable to fully mitigate the use of momentary cessation, while another 2.6 GW indicated that the use of momentary cessation can be mitigated through settings changes.

I propose that footnote 5 be modified to state “For projects that sign an interconnection agreement after the effective date of the standard, “known regulatory or equipment limitation” excludes limitations that are caused by the setting capability of the generator frequency and voltage protection itself but does not exclude limitations originating in the equipment that it protects. For inverters installed on or before that date, equipment limitations caused by the setting capability of the generator frequency and voltage protection itself is a permissible exemption under R3.” This will ensure that the Planning Coordinator and Transmission Planner is still notified of any equipment limitations, but will not require the costly retrofit of existing inverters than cannot meet the R1 and R2 requirements. We believe this strikes the appropriate balance between reliability concerns and cost.

Likes 0

Dislikes 0

Response

Karie Barczak - DTE Energy - Detroit Edison Company - 3, Group Name DTE Energy - DTE Electric

Answer

Yes

Document Name	
Comment	
Likes 0	
Dislikes 0	
Response	
Maryanne Darling-Reich - Black Hills Corporation - 1,3,5,6 - MRO,WECC	
Answer	Yes
Document Name	
Comment	
Likes 0	
Dislikes 0	
Response	
Matthew McMillan - Talen Generation, LLC - 5	
Answer	Yes
Document Name	
Comment	
Likes 0	
Dislikes 0	
Response	
Jennifer Hohenshilt - Talen Energy Marketing, LLC - 6	
Answer	Yes
Document Name	
Comment	
Likes 0	
Dislikes 0	

Response

Thomas Foltz - AEP - 5

Answer Yes

Document Name

Comment

Likes 0

Dislikes 0

Response

Leonard Kula - Independent Electricity System Operator - 2

Answer Yes

Document Name

Comment

Likes 0

Dislikes 0

Response

Chris Wagner - Santee Cooper - 1, Group Name Santee Cooper

Answer Yes

Document Name

Comment

Likes 0

Dislikes 0

Response

Dennis Chastain - Tennessee Valley Authority - 1,3,5,6 - SERC

Answer Yes

Document Name

Comment

Likes 0

Dislikes 0

Response**Eric Smith - NaturEner USA, LLC - 5****Answer**

Yes

Document Name**Comment**

Likes 0

Dislikes 0

Response**Amy Casuscelli - Amy Casuscelli On Behalf of: Gerry Huitt, Xcel Energy, Inc., 3, 1, 5; - Amy Casuscelli****Answer**

Yes

Document Name**Comment**

Likes 0

Dislikes 0

Response**Neil Swearingen - Salt River Project - 1,3,5,6 - WECC****Answer**

Yes

Document Name**Comment**

Likes 0

Dislikes 0

Response

Lana Smith - San Miguel Electric Cooperative, Inc. - 5

Answer Yes

Document Name

Comment

Likes 0

Dislikes 0

Response

David Jendras - Ameren - Ameren Services - 3

Answer Yes

Document Name

Comment

Likes 0

Dislikes 0

Response

Ozan Ferrin - Tacoma Public Utilities (Tacoma, WA) - 5

Answer Yes

Document Name

Comment

Likes 0

Dislikes 0

Response

Steven Rueckert - Western Electricity Coordinating Council - 10

Answer Yes

Document Name

Comment

Likes 0

Dislikes 0

Response

Alex Chua - Pacific Gas and Electric Company - 1,3,5

Answer

Yes

Document Name

Comment

Likes 0

Dislikes 0

Response

Kim Thomas - Duke Energy - 1,3,5,6 - FRCC,SERC,RF, Group Name Duke Energy

Answer

Yes

Document Name

Comment

Likes 0

Dislikes 0

Response

Jesus Sammy Alcaraz - Imperial Irrigation District - 1

Answer

Yes

Document Name

Comment

Likes 0

Dislikes 0

Response

Richard Jackson - U.S. Bureau of Reclamation - 1**Answer** Yes**Document Name****Comment**

Likes 0

Dislikes 0

Response**Andrew Gallo - Austin Energy - 1,3,4,5,6****Answer** Yes**Document Name****Comment**

Likes 0

Dislikes 0

Response**Shirley Mathew - Austin Energy - 5****Answer** Yes**Document Name****Comment**

Likes 1 Austin Energy, 3, Preston W. Dwayne

Dislikes 0

Response**Jodirah Green - ACES Power Marketing - 1,3,4,5,6 - MRO,WECC,Texas RE,SERC,RF, Group Name ACES Standard Collaborations****Answer** Yes**Document Name****Comment**

Likes 0

Dislikes 0

Response

Thomas Savin - New York Power Authority - 6

Answer

Yes

Document Name

Comment

Likes 0

Dislikes 0

Response

Rachel Coyne - Texas Reliability Entity, Inc. - 10

Answer

Yes

Document Name

Comment

Likes 0

Dislikes 0

Response

Nick Batty - Keys Energy Services - NA - Not Applicable - FRCC

Answer

Yes

Document Name

Comment

Likes 0

Dislikes 0

Response

Davis Jelusich - Public Utility District No. 1 of Chelan County - 6

Answer	Yes
Document Name	
Comment	
Likes 0	
Dislikes 0	
Response	
Anton Vu - Los Angeles Department of Water and Power - 6	
Answer	Yes
Document Name	
Comment	
Likes 0	
Dislikes 0	
Response	
Greg Davis - Georgia Transmission Corporation - 1	
Answer	Yes
Document Name	
Comment	
Likes 0	
Dislikes 0	
Response	
Brandon McCormick - Brandon McCormick On Behalf of: Carol Chinn, Florida Municipal Power Agency, 6, 4, 3, 5; Chris Gowder, Florida Municipal Power Agency, 6, 4, 3, 5; Darko Kovac, Gainesville Regional Utilities, 1, 5, 3; David Owens, Gainesville Regional Utilities, 1, 5, 3; Don Cuevas, Beaches Energy Services, 1, 3; Joe McKinney, Florida Municipal Power Agency, 6, 4, 3, 5; Neville Bowen, Ocala Utility Services, 3; Nick Batty, Keys Energy Services, 4; Richard Montgomery, Florida Municipal Power Agency, 6, 4, 3, 5; Steven Lancaster, Beaches Energy Services, 1, 3; Tom Reedy, Florida Municipal Power Pool, 6; - Brandon McCormick, Group Name FMPPA	
Answer	Yes
Document Name	
Comment	

Likes 0

Dislikes 0

Response

Bette White - AES - Indianapolis Power and Light Co. - 3

Answer

Yes

Document Name

Comment

Likes 0

Dislikes 0

Response

Ruida Shu - Northeast Power Coordinating Council - 1,2,3,4,5,6,7,8,9,10 - NPCC, Group Name RSC no Dominion and Con Ed

Answer

Yes

Document Name

Comment

Likes 0

Dislikes 0

Response

Leo Bernier - AES - AES Corporation - 5

Answer

Yes

Document Name

Comment

Likes 0

Dislikes 0

Response

Charles Yeung - Southwest Power Pool, Inc. (RTO) - 2, Group Name SRC

Answer Yes

Document Name

Comment

Likes 0

Dislikes 0

Response

Constantin Chitescu - Ontario Power Generation Inc. - 5

Answer Yes

Document Name

Comment

Likes 0

Dislikes 0

Response

Todd Bennett - Associated Electric Cooperative, Inc. - 3, Group Name AECI

Answer

Document Name

Comment

AECI supports the comments submitted by ACES

Likes 0

Dislikes 0

Response

Richard Vine - California ISO - 2

Answer

Document Name

Comment

The California ISO supports the comments as submitted by the ISO/RTO Council Standards Review Committee (SRC)

Likes 0

Dislikes 0

Response

Kagen DelRio - Kagen DelRio On Behalf of: doug white, North Carolina Electric Membership Corporation, 4, 3, 5; John Lemire, North Carolina Electric Membership Corporation, 4, 3, 5; Robert Beadle, North Carolina Electric Membership Corporation, 4, 3, 5; - Kagen DelRio

Answer

Document Name

Comment

NCEMC supports the comments submitted by ACES

Likes 0

Dislikes 0

Response

4. Do you agree that “momentary cessation” – like “tripping” – is well understood by industry? If not, please provide your rationale

Bradley Collard - SunPower - 5

Answer No

Document Name

Comment

SunPower believes NERC would do well by defining the term, “momentary cessation” as either part of this Standard or in the Glossary of Terms. As others have pointed out, this term relates primarily to PV Inverters. Is there a difference between “stop injecting current” and “momentary cessation?” Inverters tripping due to voltage or frequency is a function that protects the inverter and takes longer to recover. Momentary cessation may be a very temporary issue.

Likes 0

Dislikes 0

Response

Constantin Chitescu - Ontario Power Generation Inc. - 5

Answer No

Document Name

Comment

OPG supports RSC’s comments.

Likes 0

Dislikes 0

Response

Armin Klusman - CenterPoint Energy Houston Electric, LLC - 1 - Texas RE

Answer No

Document Name

Comment

CenterPoint Energy Houston Electric, LLC supports the comments submitted by the Edison Electric Institute.

Likes 0

Dislikes 0

Response	
Mark Gray - Edison Electric Institute - NA - Not Applicable - NA - Not Applicable	
Answer	No
Document Name	
Comment	
<p>While there is a better understanding of momentary cessation since the Blue Cut and Canyon 2 fires, EEI member companies do not agree that this term is sufficiently and consistently understood by industry. The SDT should define the term in the NERC Glossary of Terms to ensure consistency in application.</p> <p>To assist in this effort, we note that the Inverter-Based Resource Performance Task Force (IRPTF) provided a definition for “momentary cessation” within their assessment titled “Resource Loss Protection Criteria Assessment NERC Inverter-Based Resource Performance Task Force (IRPTF) White Paper – February 2018” (see below):</p> <p>Momentary cessation is defined as an inverter operating mode where the inverter temporarily ceases injection of active and reactive current (“zero current injection”) into the point of connection with the grid. The power electronic firing commands are blocked, and therefore the inverter does not exchange any current (real or reactive) with the grid. Other operating modes where active or reactive power are prioritized based on inverter controls are not considered momentary cessation since the power electronic switches are still firing and current is being exchanged with the grid.</p> <p>Additionally, we note that within IEEE Standard 1547 “momentary cessation” is also defined as:</p> <p>momentary cessation: Temporarily cease to energize an EPS, while connected to the Area EPS, in response to a disturbance of the applicable voltages or the system frequency, with the capability of immediate Restore Output of operation when the applicable voltages and the system frequency return to within defined ranges.</p> <p>Other Related definitions within IEEE 1547 include:</p> <p>cease to energize: Cessation of active power delivery under steady-state and transient conditions and limitation of reactive power exchange.</p> <p>applicable voltage: Electrical quantities that determine the performance of a Local EPS or DER specified with regard to the reference point of applicability, individual phase-to-neutral, phase-to-ground, or phase to-phase combination and time resolution.</p> <p>restore output: Return operation of the DER to the state prior to the abnormal excursion of voltage or frequency that resulted in a ride-through operation of the DER.</p> <p>reference point of applicability (RPA): The location where the interconnection and interoperability performance requirements specified in this standard apply</p>	
Likes	0
Dislikes	0
Response	
Leo Bernier - AES - AES Corporation - 5	
Answer	No

Document Name	
Comment	
A definition of momentary cessation as it applies to PRC-024-3 should be included in the suggested "Definitions" section of the new Standard as stated in AES' response to Question 1.	
Likes 0	
Dislikes 0	
Response	
Ruida Shu - Northeast Power Coordinating Council - 1,2,3,4,5,6,7,8,9,10 - NPCC, Group Name RSC no Dominion and Con Ed	
Answer	No
Document Name	
Comment	
We suggest that the term "momentary cessation" be defined within the standard to avoid misunderstanding.	
Likes 0	
Dislikes 0	
Response	
Bette White - AES - Indianapolis Power and Light Co. - 3	
Answer	No
Document Name	
Comment	
A definition of momentary cessation as it applies to PRC-024-3 should be included in the suggested "Definitions" section of the new Standard as stated in IPL's response to Question 1.	
Likes 0	
Dislikes 0	
Response	
Sandra Shaffer - Berkshire Hathaway - PacifiCorp - 6	
Answer	No
Document Name	

Comment

Comments: Currently, the NSRF can only refer to the February 2018 Modeling Notification: Recommended Practices of Modeling Momentary Cessation. Where Momentary cessation is

an inverter operating state where the power electronic “firing commands” are blocked such that both active current and reactive current go to zero output. Since this is not defined by NERC, we do not know if a Compliance Enforcement Agency would use a different definition for Momentary Cessation. Please consider a definition for Momentary Cessation.

Likes 0

Dislikes 0

Response

Douglas Webb - Douglas Webb On Behalf of: Allen Klassen, Westar Energy, 6, 3, 1, 5; Bryan Taggart, Westar Energy, 6, 3, 1, 5; Derek Brown, Westar Energy, 6, 3, 1, 5; Grant Wilkerson, Westar Energy, 6, 3, 1, 5; James McBee, Great Plains Energy - Kansas City Power and Light Co., 1, 3, 6, 5; Jennifer Flandermeyer, Great Plains Energy - Kansas City Power and Light Co., 1, 3, 6, 5; John Carlson, Great Plains Energy - Kansas City Power and Light Co., 1, 3, 6, 5; Marcus Moor, Great Plains Energy - Kansas City Power and Light Co., 1, 3, 6, 5; - Douglas Webb, Group Name Westar-KCPL

Answer

No

Document Name

Comment

Comments: Kansas City Power & Light Company and Westar endorses comments submitted by EEI member companies.

Likes 0

Dislikes 0

Response

Jamie Monette - Allete - Minnesota Power, Inc. - 1

Answer

No

Document Name

Comment

Even if the term is thought to be well understood, it should be clearly defined either in this standard or in the NERC Glossary of Terms.

Likes 0

Dislikes 0

Response

Greg Davis - Georgia Transmission Corporation - 1

Answer No

Document Name

Comment

This topic is somewhat new to the industry and the growth of the renewable energy requires additional focus and elaboration on this topic by NERC.

Likes 0

Dislikes 0

Response

Davis Jelusich - Public Utility District No. 1 of Chelan County - 6

Answer No

Document Name

Comment

Momentary cessation is not well understood by Entities with no inverter-based generation resources. It would benefit industry if the term was defined or discussed in PRC-024-3, Compliance Guidance, or the Glossary of Terms Used in NERC Reliability Standards.

Likes 0

Dislikes 0

Response

Alyssa Hubbard - SCANA - South Carolina Electric and Gas Co. - 5

Answer No

Document Name

Comment

I am in agreement with comments submitted by Sean Bodkin-Dominion.

Likes 0

Dislikes 0

Response

Rachel Coyne - Texas Reliability Entity, Inc. - 10

Answer	No
Document Name	
Comment	
Texas RE recommends the SDT consider defining the term momentary cessation. While momentary cessation is a familiar term for PV power plants, wind and other renewable generation resources have different terminology for ceasing power injection. If the term is defined, there is a greater chance it will be consistently applied.	
Likes 0	
Dislikes 0	
Response	
Thomas Savin - New York Power Authority - 6	
Answer	No
Document Name	
Comment	
We suggest that the term "momentary cessation" be defined within the NERC Glossary of Terms or the standard to avoid misunderstanding.	
Likes 0	
Dislikes 0	
Response	
Jodirah Green - ACES Power Marketing - 1,3,4,5,6 - MRO,WECC,Texas RE,SERC,RF, Group Name ACES Standard Collaborations	
Answer	No
Document Name	
Comment	
This topic is somewhat new to the industry and the growth of the renewable energy requires additional focus and elaboration on this topic by NERC.	
Likes 1	Associated Electric Cooperative, Inc., 1, Ziegler Ryan
Dislikes 0	
Response	
Pamela Hunter - Southern Company - Southern Company Services, Inc. - 1,3,5,6 - SERC, Group Name Southern Company	
Answer	No

Document Name	
Comment	
<p>Many in the industry incorrectly equate momentary cessation with tripping. Momentary cessation is quite different from tripping. It is a control action rather than a protection system action. Protective relaying systems and schemes trip generating facilities using auxiliary/lockout relays and power circuit breakers, and require manual intervention so that investigation, analysis, reset, and restorative actions may be taken. The action taken by momentary cessation functions, whereby an automatic restoration/return to pre-disturbance conditions is executed, is similar to, and much closer in comparison to, a control system limiter rather than a generator protection system whose action is to trip. The temporary limitations or temporary changes to the mode-of-control performed by the momentary cessation portion of the control system does not trip the unit in the traditional protection system fashion of operation. Including this control system action does not fit the title and purpose of this standard. The inclusion of this control system action requirement transforms this standard into a entire facility ride-thru performance standard. The addition of "continuing to support the BES" as a change in the purpose statement furthers this effort to change the standard from a protection setting standard to a plant performance standard. The original draft versions of PRC-024-1 attempted to establish a plant performance ride-thru standard, and the overwhelming negative industry vote for that version of the standard clearly demonstrated the objection to this type of standard.</p>	
Likes	0
Dislikes	0
Response	
Scott Langston - Tallahassee Electric (City of Tallahassee, FL) - 1	
Answer	No
Document Name	
Comment	
<p>Momentary cessation is a relatively new term , especially to those that do not currently have inverter based generation.</p>	
Likes	0
Dislikes	0
Response	
Allen Schriver - NextEra Energy - 5	
Answer	No
Document Name	
Comment	
<p>Comments: Tripping is associated with a mechanical action and the facility typically goes "off-line". Momentary cessation is only associated with the operation of inverter technology. Technically, when the inverter goes into momentary cessation, it may, or may not, "trip" the facility; thus, it may, or may not, go "off-line".</p>	
Likes	0

Dislikes 0

Response

Scott Parker - SCANA - South Carolina Electric and Gas Co. - 3

Answer No

Document Name

Comment

I am in agreement with comments submitted by Sean Bodkin-Dominion.

Likes 0

Dislikes 0

Response

Shirley Mathew - Austin Energy - 5

Answer No

Document Name

Comment

“Tripping” is associated with opening of an electric circuit via an interrupting device and separating the electrical equipment from the grid. The opening of the circuit will not conduct electricity until the interrupting device is closed back to regain the continuous loop circuit. Tripping of an interrupting device has inherent time delay which includes detection time, computation time, tripping signal transmit time and interrupting device opening time.

“Momentary cessation” is an inverter ‘open state’ of an electronic component. There is no interrupting device disconnecting the electrical equipment. However, the industry considers “momentary cessation” in the same meaning as “tripping”.

Momentary cessation = Active current is not produced

Tripping = Active current is interrupted

Likes 1 Austin Energy, 3, Preston W. Dwayne

Dislikes 0

Response

Andrew Gallo - Austin Energy - 1,3,4,5,6

Answer No

Document Name

Comment

“Tripping” is associated with opening of an electric circuit via an interrupting device and separating the electrical equipment from the grid. The opening of the circuit will not conduct electricity until the interrupting device is closed back to regain the continuous loop circuit. Tripping of an interrupting device has inherent time delay which includes detection time, computation time, tripping signal transmit time and interrupting device opening time.

“Momentary cessation” is an inverter ‘open state’ of an electronic component. There’s no interrupting device disconnecting the electrical equipment. However, the industry considers “momentary cessation” in the same meaning as “tripping”.

Momentary cessation = Active current is not produced

Tripping = Active current is interrupted

Likes 0

Dislikes 0

Response

Richard Jackson - U.S. Bureau of Reclamation - 1

Answer

No

Document Name

Comment

This term is not as well-known as “tripping” to those in the industry who are strictly compliance professionals. Explanation is warranted.

Likes 0

Dislikes 0

Response

Tom Hanzlik - SCANA - South Carolina Electric and Gas Co. - 1

Answer

No

Document Name

Comment

I agree with the comments submitted by Sean Bodkin-Dominion

Likes 0

Dislikes 0

Response

RoLynda Shumpert - SCANA - South Carolina Electric and Gas Co. - 1,3,5,6 - SERC

Answer	No
Document Name	
Comment	
SCANA- South Carolina Electric and Gas (Dominion Energy South Carolina) is in agreement with comments form Sean Bodkin (Dominion Energy).	
Likes 0	
Dislikes 0	
Response	
Jeremy Voll - Basin Electric Power Cooperative - 1,3,5,6	
Answer	No
Document Name	
Comment	
Support the MRO NSRF Comments	
Likes 0	
Dislikes 0	
Response	
Kim Thomas - Duke Energy - 1,3,5,6 - FRCC,SERC,RF, Group Name Duke Energy	
Answer	No
Document Name	
Comment	
Duke Energy believes that issues at IBR facilities such as momentary cessation and tripping due to PLL error, as well as other protection and controls systems design features that can cause facility curtailment, are not well understood by industry. The language of the standard needs to be generic enough to cover any of these design features that can cause facility curtailment for any reason under frequency and voltage disturbances.	
Likes 0	
Dislikes 0	
Response	
Don Schmit - Nebraska Public Power District - 1,3,5	
Answer	No

Document Name

Comment

NPPD supports the comments submitted by the MRO NSRF.

Likes 0

Dislikes 0

Response

Scott Berry - Scott Berry On Behalf of: Jack Alvey, Indiana Municipal Power Agency, 1, 4; - Scott Berry

Answer

No

Document Name

Comment

Momentary cessation is a vague term and can have different meanings in the industry. If the standard keeps this term, it should be defined to eliminate the vagueness of the term.

Likes 0

Dislikes 0

Response

Matthew Nutsch - Seattle City Light - 1,3,4,5,6 - WECC

Answer

No

Document Name

Comment

It would be helpful to define this term, though its meaning can be deduced by it's context and the definition of cessation.

Likes 0

Dislikes 0

Response

Dana Klem - MRO - 1,2,3,4,5,6 - MRO, Group Name MRO NSRF

Answer

No

Document Name

Comment

Currently, the NSRF can only refer to the February 2018 Modeling Notification: Recommended Practices of Modeling Momentary Cessation. Where Momentary cessation is an inverter operating state where the power electronic “firing commands” are blocked such that both active current and reactive current go to zero output. Since this is not defined by NERC, we do not know if a Compliance Enforcement Agency would use a different definition for Momentary Cessation. Please consider a definition for Momentary Cessation.

Likes 0

Dislikes 0

Response

Michelle Amarantos - APS - Arizona Public Service Co. - 1

Answer

No

Document Name

Comment

As discussed above, many different definitions of “momentary cessation” are being advanced in industry. While AZPS subject matter experts have a good understanding of what momentary cessation means to them, the potential for various and varied meanings and applications could reduce the value and benefit of this standard to reliability and create complications and unintended consequences during real-time operations.

Likes 0

Dislikes 0

Response

Ozan Ferrin - Tacoma Public Utilities (Tacoma, WA) - 5

Answer

No

Document Name

Comment

Not everyone in the industry deals with DC power and inverters

Likes 0

Dislikes 0

Response

Lana Smith - San Miguel Electric Cooperative, Inc. - 5

Answer

No

Document Name

Comment

The term, "momentary cessation," may not be well understood by entities that do not own inverter-based resources, and should be explained in PRC-024-3

Likes 0

Dislikes 0

Response

Neil Swearingen - Salt River Project - 1,3,5,6 - WECC

Answer

No

Document Name

Comment

Momentary cessation is used with inverter based resources (solar panels). Those resources are not in everyone's fleet and may not have been studied by protection engineers. Concerns arise as to why there is momentary cessation, exactly when it is triggered, when does it resume, and can those trigger points be changed?

Likes 0

Dislikes 0

Response

Kayleigh Wilkerson - Lincoln Electric System - 5, Group Name Lincoln Electric System

Answer

No

Document Name

Comment

Although the term may be well understood by owners of inverter-based facilities, including time parameters may provide additional clarity for those that do not currently own or operate these types of facilities as well as improve consistency in future enforcement activities.

Likes 0

Dislikes 0

Response

Sergey Kynev - Siemens - Siemens Energy, Inc. - NA - Not Applicable - NA - Not Applicable

Answer

No

Document Name

Comment

“Momentary cessation”, as it is defined in other NERC documents, refers to as "blocking" of inverter. Blocking is well understood term among manufactures of inverters. However, it seems that "momentary cessation" also covers the period after blocking, then current output is recovering to its pre-fault value. Therefore, it is not clear if any limitation of inverter current output is referred as "momentary cessation" or only the one, that involve blocking. For instance, if an inverter reduces its current output to 10% (could be any value) of its original value during a fault, but does not block, would it be considered a "momentary cessation"?

Likes 0

Dislikes 0

Response**Glen Farmer - Avista - Avista Corporation - 5****Answer**

No

Document Name**Comment**

agree with EEI.

Likes 0

Dislikes 0

Response**Jeanne Kurzynowski - CMS Energy - Consumers Energy Company - 1,3,4,5 - RF****Answer**

No

Document Name**Comment**

The concept of “momentary cessation” may be well understood, however it is doubtful that the behavior of existing installed power producing resources is understood. Typical power producing resource documentation does not include the terminology “momentary cessation”.

Likes 0

Dislikes 0

Response**Jennifer Hohenshilt - Talen Energy Marketing, LLC - 6****Answer**

No

Document Name	
Comment	
The Term, "momentary cessation," may not be well understood by entities that do not own inverter-based resources, and should be explained in PRC-024-3.	
Likes 0	
Dislikes 0	
Response	
Matthew McMillan - Talen Generation, LLC - 5	
Answer	No
Document Name	
Comment	
The term, "momentary cessation," may not be well understood by entities that do not own inverter-based resources, and should be explained in PRC-024-3.	
Likes 0	
Dislikes 0	
Response	
Chris Scanlon - Exelon - 1	
Answer	Yes
Document Name	
Comment	
The meaning of Momentary Cessation is becoming more know in the industry. The term as utilized in the Standard should be formally defined in the NERC Glossary of Terms.	
Exelon, Segments 1, 3, 5, 6	
Likes 0	
Dislikes 0	
Response	
Aaron Cavanaugh - Bonneville Power Administration - 1,3,5,6 - WECC	

Answer	Yes
Document Name	
Comment	
None	
Likes 0	
Dislikes 0	
Response	
Leonard Kula - Independent Electricity System Operator - 2	
Answer	Yes
Document Name	
Comment	
In Ontario, momentary cessation – like tripping is well understood.	
Likes 0	
Dislikes 0	
Response	
Charles Yeung - Southwest Power Pool, Inc. (RTO) - 2, Group Name SRC	
Answer	Yes
Document Name	
Comment	
Likes 0	
Dislikes 0	
Response	
Brandon McCormick - Brandon McCormick On Behalf of: Carol Chinn, Florida Municipal Power Agency, 6, 4, 3, 5; Chris Gowder, Florida Municipal Power Agency, 6, 4, 3, 5; Darko Kovac, Gainesville Regional Utilities, 1, 5, 3; David Owens, Gainesville Regional Utilities, 1, 5, 3; Don Cuevas, Beaches Energy Services, 1, 3; Joe McKinney, Florida Municipal Power Agency, 6, 4, 3, 5; Neville Bowen, Ocala Utility Services, 3; Nick Batty, Keys Energy Services, 4; Richard Montgomery, Florida Municipal Power Agency, 6, 4, 3, 5; Steven Lancaster, Beaches Energy Services, 1, 3; Tom Reedy, Florida Municipal Power Pool, 6; - Brandon McCormick, Group Name FMPPA	
Answer	Yes

Document Name	
Comment	
Likes 0	
Dislikes 0	
Response	
Anton Vu - Los Angeles Department of Water and Power - 6	
Answer	Yes
Document Name	
Comment	
Likes 0	
Dislikes 0	
Response	
Nick Batty - Keys Energy Services - NA - Not Applicable - FRCC	
Answer	Yes
Document Name	
Comment	
Likes 0	
Dislikes 0	
Response	
Jesus Sammy Alcaraz - Imperial Irrigation District - 1	
Answer	Yes
Document Name	
Comment	
Likes 0	
Dislikes 0	

Response

Alex Chua - Pacific Gas and Electric Company - 1,3,5

Answer Yes

Document Name

Comment

Likes 0

Dislikes 0

Response

Steven Rueckert - Western Electricity Coordinating Council - 10

Answer Yes

Document Name

Comment

Likes 0

Dislikes 0

Response

David Jendras - Ameren - Ameren Services - 3

Answer Yes

Document Name

Comment

Likes 0

Dislikes 0

Response

Amy Casuscelli - Amy Casuscelli On Behalf of: Gerry Huitt, Xcel Energy, Inc., 3, 1, 5; - Amy Casuscelli

Answer Yes

Document Name

Comment

Likes 0

Dislikes 0

Response**Eric Smith - NaturEner USA, LLC - 5****Answer**

Yes

Document Name**Comment**

Likes 0

Dislikes 0

Response**Dennis Chastain - Tennessee Valley Authority - 1,3,5,6 - SERC****Answer**

Yes

Document Name**Comment**

Likes 0

Dislikes 0

Response**Chris Wagner - Santee Cooper - 1, Group Name Santee Cooper****Answer**

Yes

Document Name**Comment**

Likes 0

Dislikes 0

Response

Thomas Foltz - AEP - 5

Answer Yes

Document Name

Comment

Likes 0

Dislikes 0

Response

Maryanne Darling-Reich - Black Hills Corporation - 1,3,5,6 - MRO,WECC

Answer Yes

Document Name

Comment

Likes 0

Dislikes 0

Response

Karie Barczak - DTE Energy - Detroit Edison Company - 3, Group Name DTE Energy - DTE Electric

Answer Yes

Document Name

Comment

Likes 0

Dislikes 0

Response

Kagen DelRio - Kagen DelRio On Behalf of: doug white, North Carolina Electric Membership Corporation, 4, 3, 5; John Lemire, North Carolina Electric Membership Corporation, 4, 3, 5; Robert Beadle, North Carolina Electric Membership Corporation, 4, 3, 5; - Kagen DelRio

Answer

Document Name

Comment

NCEMC supports the comments submitted by ACES

Likes 0

Dislikes 0

Response**Richard Vine - California ISO - 2****Answer****Document Name****Comment**

The California ISO supports the comments as submitted by the ISO/RTO Council Standards Review Committee (SRC)

Likes 0

Dislikes 0

Response**Todd Bennett - Associated Electric Cooperative, Inc. - 3, Group Name AECI****Answer****Document Name****Comment**

AECI supports the comments submitted by ACES

Likes 0

Dislikes 0

Response**Sean Bodkin - Dominion - Dominion Resources, Inc. - 6, Group Name Dominion****Answer****Document Name****Comment**

While there is a better understanding of momentary cessation since the Blue Cut and Canyon 2 fires, Dominion Energy does not agree that this term is sufficiently and consistently understood by all stakeholders. The SDT should define the term in the NERC Glossary of Terms to ensure consistency in understanding.

To assist in this effort, Dominion Energy has identified that the Inverter-Based Resource Performance Task Force (IRPTF) provided a definition for “momentary cessation” within their assessment titled “Resource Loss Protection Criteria Assessment NERC Inverter-Based Resource Performance Task Force (IRPTF) White Paper – February 2018” (see below):

Momentary cessation is defined as an inverter operating mode where the inverter temporarily ceases injection of active and reactive current (“zero current injection”) into the point of connection with the grid. The power electronic firing commands are blocked, and therefore the inverter does not exchange any current (real or reactive) with the grid. Other operating modes where active or reactive power are prioritized based on inverter controls are not considered momentary cessation since the power electronic switches are still firing and current is being exchanged with the grid.

Additionally, we note that within IEEE Standard 1547 “momentary cessation” is also defined as:

momentary cessation: Temporarily cease to energize an EPS, while connected to the Area EPS, in response to a disturbance of the applicable voltages or the system frequency, with the capability of immediate Restore Output of operation when the applicable voltages and the system frequency return to within defined ranges.

Likes 1

SCANA - South Carolina Electric and Gas Co., 1,3,5,6, Shumpert RoLynda

Dislikes 0

Response

5. The SDT was apprised that, in some instances, the TO may own the GSU or collector transformers. As such, TOs were added to the applicable entity for cases where they may own a GSU or collector transformers with frequency and voltage protection enabled. Do you agree with the addition of TOs who own a GSU or collector transformer to the applicable entities? If not, please provide your rationale

Glen Farmer - Avista - Avista Corporation - 5

Answer No

Document Name

Comment

agree with EEI.

Likes 0

Dislikes 0

Response

Sean Bodkin - Dominion - Dominion Resources, Inc. - 6, Group Name Dominion

Answer No

Document Name

Comment

Dominion Energy does not agree that TOs should be added to the Applicability section of PRC-024-3. PRC-024 is a Reliability Standard that was developed to ensure that protective relay settings were developed and set in a manner that ensure that generating resources remain connected to the BES during defined frequency and voltage excursions. Mere ownership of GSUs or collector transformers does not represent an integral part of the affected relay protection beyond some possible shared devices (i.e., voltage and current sensing devices) providing input to affected protection functions. Dominion Energy is not aware of any TOs that own generator protective relays unless they are also registered as a GO in which case they would be obligated under PRC-024 to comply with the Reliability Standard requirements for these devices as a GO. In addition, such devices are not protection devices and therefore do not warrant making owners of these Facilities applicable entities under this Reliability Standard. Dominion Energy is also unaware of any reliability incident where a BES generating resource failed to perform within the requirements of PRC-024 as a result of a TO owning a GSU or collector transformer, so we are unaware of any reliability risk that might merit such a change.

Likes 1 SCANA - South Carolina Electric and Gas Co., 1,3,5,6, Shumpert RoLynda

Dislikes 0

Response

Dennis Chastain - Tennessee Valley Authority - 1,3,5,6 - SERC

Answer No

Document Name

Comment

The scope of the standard is for generator protection. How does that include transformer protection?

Likes 0

Dislikes 0

Response

Michelle Amarantos - APS - Arizona Public Service Co. - 1

Answer No

Document Name

Comment

While AZPS understands why the TO and aforementioned equipment was added to this proposed revision of PRC-024, AZPS respectfully submits that this equipment is not intended for the protection of the generators and that, to include them in this standard, results in an inappropriate shift of compliance and cost responsibility from the GO to the TO. Further, the TO already has responsibility for relay and other protections associated with its operation of its transmission system. If additional responsibilities were to be added, revisions associated therewith should, for consistency reasons, be applied within the existing standards associated with these obligations. For these reasons, AZPS submits that the SDT should not include TOs or their equipment relative to PRC-024.

Likes 0

Dislikes 0

Response

Tom Hanzlik - SCANA - South Carolina Electric and Gas Co. - 1

Answer No

Document Name

Comment

I agree with the comments submitted by Sean Bodkin-Dominion

Likes 0

Dislikes 0

Response

Scott Parker - SCANA - South Carolina Electric and Gas Co. - 3

Answer No

Document Name	
Comment	
I am in agreement with comments submitted by Sean Bodkin-Dominion.	
Likes 0	
Dislikes 0	
Response	
Allen Schriver - NextEra Energy - 5	
Answer	No
Document Name	
Comment	
Comments: Transmission Owners (TOs) that own asynchronous ties must also be included. Transmission asynchronous interties exhibit the same momentary cessation issues due to voltage and frequency excursions as solar inverters, (see the Pacific DC Intertie information in the WECC May 11, 2018 event report). Any revisions to the Standard should include asynchronous interties in order to properly address the concerns associated with all inverter operations.	
Likes 0	
Dislikes 0	
Response	
Pamela Hunter - Southern Company - Southern Company Services, Inc. - 1,3,5,6 - SERC, Group Name Southern Company	
Answer	No
Document Name	
Comment	
This standard was originally written for generator protective relaying. The proposed scope change make it written for generator protection. Relaying owned by the TO for transformer protection is not in the scope of this standard. The TO does not have protection elements on the GO's generator.	
Likes 0	
Dislikes 0	
Response	
Thomas Savin - New York Power Authority - 6	
Answer	No

Document Name	
Comment	
The focus of the standard should be on the Generator Owner's protective devices. It is not necessary to add Transmission Owners to the applicability of the standard simply because some Transmission Owners may own Elements that are being tripped by the Generator Owner's protective devices.	
Likes 0	
Dislikes 0	
Response	
Alyssa Hubbard - SCANA - South Carolina Electric and Gas Co. - 5	
Answer	No
Document Name	
Comment	
I am in agreement with comments submitted by Sean Bodkin-Dominion.	
Likes 0	
Dislikes 0	
Response	
Douglas Webb - Douglas Webb On Behalf of: Allen Klassen, Westar Energy, 6, 3, 1, 5; Bryan Taggart, Westar Energy, 6, 3, 1, 5; Derek Brown, Westar Energy, 6, 3, 1, 5; Grant Wilkerson, Westar Energy, 6, 3, 1, 5; James McBee, Great Plains Energy - Kansas City Power and Light Co., 1, 3, 6, 5; Jennifer Flandermeyer, Great Plains Energy - Kansas City Power and Light Co., 1, 3, 6, 5; John Carlson, Great Plains Energy - Kansas City Power and Light Co., 1, 3, 6, 5; Marcus Moor, Great Plains Energy - Kansas City Power and Light Co., 1, 3, 6, 5; - Douglas Webb, Group Name Westar-KCPL	
Answer	No
Document Name	
Comment	
Comments: Kansas City Power & Light Company and Westar endorses comments submitted by EEI member companies.	
Likes 0	
Dislikes 0	
Response	
Ruida Shu - Northeast Power Coordinating Council - 1,2,3,4,5,6,7,8,9,10 - NPCC, Group Name RSC no Dominion and Con Ed	

Answer	No
Document Name	
Comment	
<p>The focus of the standard should be on the Generator Owner's protective devices. We believe that it is not necessary to add Transmission Owners to the applicability of the standard simply because some Transmission Owners may own Elements that are being tripped by the Generator Owner's protective devices.</p>	
Likes 0	
Dislikes 0	
Response	
Mark Gray - Edison Electric Institute - NA - Not Applicable - NA - Not Applicable	
Answer	No
Document Name	
Comment	
<p>EI member companies do not agree that TOs should be added to the Applicability section of PRC-024-3. PRC-024 is a Reliability Standard that was developed to ensure that protective relay settings were developed and set in a manner that ensure that generating resources remain connected to the BES during defined frequency and voltage excursions. EI member companies are also not aware of any TOs that own generator protective relays unless they are also registered as a GO in which case they would be obligated under PRC-024 to comply with the Reliability Standard requirements for these devices as a GO. For these reasons, EI member companies do not support the proposed changes in applicability which we believe create new compliance requirements that do not provide any known benefits to reliability.</p>	
Likes 0	
Dislikes 0	
Response	
Armin Klusman - CenterPoint Energy Houston Electric, LLC - 1 - Texas RE	
Answer	No
Document Name	
Comment	
<p>CenterPoint Energy Houston Electric, LLC supports the comments submitted by the Edison Electric Institute.</p>	
Likes 0	
Dislikes 0	
Response	

RoLynda Shumpert - SCANA - South Carolina Electric and Gas Co. - 1,3,5,6 - SERC

Answer No

Document Name

Comment

Likes 0

Dislikes 0

Response

Thomas Foltz - AEP - 5

Answer Yes

Document Name

Comment

While AEP does not object to the TO as specified being brought into applicability, there may be instances where the GSU or collector transformer is owned by one Registered Entity while the protection (as specified in Section 4.2.1) is owned by a different Registered Entity. As currently drafted, the transformer assets in this scenario would not technically be within the scope of the standard.

Likes 0

Dislikes 0

Response

Aaron Cavanaugh - Bonneville Power Administration - 1,3,5,6 - WECC

Answer Yes

Document Name

Comment

None

Likes 0

Dislikes 0

Response

Chris Scanlon - Exelon - 1

Answer	Yes
Document Name	
Comment	
Exelon, Segments 1, 3, 5, 6	
Likes	0
Dislikes	0
Response	
Karie Barczak - DTE Energy - Detroit Edison Company - 3, Group Name DTE Energy - DTE Electric	
Answer	Yes
Document Name	
Comment	
Likes	0
Dislikes	0
Response	
Maryanne Darling-Reich - Black Hills Corporation - 1,3,5,6 - MRO,WECC	
Answer	Yes
Document Name	
Comment	
Likes	0
Dislikes	0
Response	
Matthew McMillan - Talen Generation, LLC - 5	
Answer	Yes
Document Name	
Comment	

Likes 0

Dislikes 0

Response

Jennifer Hohenshilt - Talen Energy Marketing, LLC - 6

Answer

Yes

Document Name

Comment

Likes 0

Dislikes 0

Response

Leonard Kula - Independent Electricity System Operator - 2

Answer

Yes

Document Name

Comment

Likes 0

Dislikes 0

Response

Jeanne Kurzynowski - CMS Energy - Consumers Energy Company - 1,3,4,5 - RF

Answer

Yes

Document Name

Comment

Likes 0

Dislikes 0

Response

Chris Wagner - Santee Cooper - 1, Group Name Santee Cooper

Answer	Yes
Document Name	
Comment	
Likes 0	
Dislikes 0	
Response	
Eric Smith - NaturEner USA, LLC - 5	
Answer	Yes
Document Name	
Comment	
Likes 0	
Dislikes 0	
Response	
Amy Casuscelli - Amy Casuscelli On Behalf of: Gerry Huitt, Xcel Energy, Inc., 3, 1, 5; - Amy Casuscelli	
Answer	Yes
Document Name	
Comment	
Likes 0	
Dislikes 0	
Response	
Kayleigh Wilkerson - Lincoln Electric System - 5, Group Name Lincoln Electric System	
Answer	Yes
Document Name	
Comment	
Likes 0	

Dislikes 0

Response

Neil Swearingen - Salt River Project - 1,3,5,6 - WECC

Answer

Yes

Document Name

Comment

Likes 0

Dislikes 0

Response

Lana Smith - San Miguel Electric Cooperative, Inc. - 5

Answer

Yes

Document Name

Comment

Likes 0

Dislikes 0

Response

David Jendras - Ameren - Ameren Services - 3

Answer

Yes

Document Name

Comment

Likes 0

Dislikes 0

Response

Ozan Ferrin - Tacoma Public Utilities (Tacoma, WA) - 5

Answer

Yes

Document Name	
Comment	
Likes 0	
Dislikes 0	
Response	
Dana Klem - MRO - 1,2,3,4,5,6 - MRO, Group Name MRO NSRF	
Answer	Yes
Document Name	
Comment	
Likes 0	
Dislikes 0	
Response	
Steven Rueckert - Western Electricity Coordinating Council - 10	
Answer	Yes
Document Name	
Comment	
Likes 0	
Dislikes 0	
Response	
Matthew Nutsch - Seattle City Light - 1,3,4,5,6 - WECC	
Answer	Yes
Document Name	
Comment	
Likes 0	
Dislikes 0	

Response

Alex Chua - Pacific Gas and Electric Company - 1,3,5

Answer Yes

Document Name

Comment

Likes 0

Dislikes 0

Response

Don Schmit - Nebraska Public Power District - 1,3,5

Answer Yes

Document Name

Comment

Likes 0

Dislikes 0

Response

Kim Thomas - Duke Energy - 1,3,5,6 - FRCC,SERC,RF, Group Name Duke Energy

Answer Yes

Document Name

Comment

Likes 0

Dislikes 0

Response

Jeremy Voll - Basin Electric Power Cooperative - 1,3,5,6

Answer Yes

Document Name

Comment

Likes 0

Dislikes 0

Response**Jesus Sammy Alcaraz - Imperial Irrigation District - 1****Answer**

Yes

Document Name**Comment**

Likes 0

Dislikes 0

Response**Richard Jackson - U.S. Bureau of Reclamation - 1****Answer**

Yes

Document Name**Comment**

Likes 0

Dislikes 0

Response**Andrew Gallo - Austin Energy - 1,3,4,5,6****Answer**

Yes

Document Name**Comment**

Likes 0

Dislikes 0

Response

Shirley Mathew - Austin Energy - 5

Answer Yes

Document Name

Comment

Likes 1 Austin Energy, 3, Preston W. Dwayne

Dislikes 0

Response

Scott Langston - Tallahassee Electric (City of Tallahassee, FL) - 1

Answer Yes

Document Name

Comment

Likes 0

Dislikes 0

Response

Jodirah Green - ACES Power Marketing - 1,3,4,5,6 - MRO,WECC,Texas RE,SERC,RF, Group Name ACES Standard Collaborations

Answer Yes

Document Name

Comment

Likes 0

Dislikes 0

Response

Rachel Coyne - Texas Reliability Entity, Inc. - 10

Answer Yes

Document Name

Comment

Likes 0

Dislikes 0

Response

Nick Batty - Keys Energy Services - NA - Not Applicable - FRCC

Answer

Yes

Document Name

Comment

Likes 0

Dislikes 0

Response

Davis Jelusich - Public Utility District No. 1 of Chelan County - 6

Answer

Yes

Document Name

Comment

Likes 0

Dislikes 0

Response

Anton Vu - Los Angeles Department of Water and Power - 6

Answer

Yes

Document Name

Comment

Likes 0

Dislikes 0

Response

Greg Davis - Georgia Transmission Corporation - 1

Answer Yes

Document Name

Comment

Likes 0

Dislikes 0

Response

Brandon McCormick - Brandon McCormick On Behalf of: Carol Chinn, Florida Municipal Power Agency, 6, 4, 3, 5; Chris Gowder, Florida Municipal Power Agency, 6, 4, 3, 5; Darko Kovac, Gainesville Regional Utilities, 1, 5, 3; David Owens, Gainesville Regional Utilities, 1, 5, 3; Don Cuevas, Beaches Energy Services, 1, 3; Joe McKinney, Florida Municipal Power Agency, 6, 4, 3, 5; Neville Bowen, Ocala Utility Services, 3; Nick Batty, Keys Energy Services, 4; Richard Montgomery, Florida Municipal Power Agency, 6, 4, 3, 5; Steven Lancaster, Beaches Energy Services, 1, 3; Tom Reedy, Florida Municipal Power Pool, 6; - Brandon McCormick, Group Name FMPA

Answer Yes

Document Name

Comment

Likes 0

Dislikes 0

Response

Jamie Monette - Allete - Minnesota Power, Inc. - 1

Answer Yes

Document Name

Comment

Likes 0

Dislikes 0

Response

Sandra Shaffer - Berkshire Hathaway - PacifiCorp - 6

Answer Yes

Document Name

Comment

Likes 0

Dislikes 0

Response**Bette White - AES - Indianapolis Power and Light Co. - 3****Answer**

Yes

Document Name**Comment**

Likes 0

Dislikes 0

Response**Leo Bernier - AES - AES Corporation - 5****Answer**

Yes

Document Name**Comment**

Likes 0

Dislikes 0

Response**Charles Yeung - Southwest Power Pool, Inc. (RTO) - 2, Group Name SRC****Answer**

Yes

Document Name**Comment**

Likes 0

Dislikes 0

Response

Constantin Chitescu - Ontario Power Generation Inc. - 5

Answer Yes

Document Name

Comment

Likes 0

Dislikes 0

Response

Bradley Collard - SunPower - 5

Answer Yes

Document Name

Comment

Likes 0

Dislikes 0

Response

Todd Bennett - Associated Electric Cooperative, Inc. - 3, Group Name AECI

Answer

Document Name

Comment

AECI supports the comments submitted by ACES

Likes 0

Dislikes 0

Response

Richard Vine - California ISO - 2

Answer

Document Name

Comment

The California ISO supports the comments as submitted by the ISO/RTO Council Standards Review Committee (SRC)

Likes 0

Dislikes 0

Response

Kagen DelRio - Kagen DelRio On Behalf of: doug white, North Carolina Electric Membership Corporation, 4, 3, 5; John Lemire, North Carolina Electric Membership Corporation, 4, 3, 5; Robert Beadle, North Carolina Electric Membership Corporation, 4, 3, 5; - Kagen DelRio

Answer

Document Name

Comment

NCEMC supports the comments submitted by ACES

Likes 0

Dislikes 0

Response

6. Another intent of the facilities section was to clarify that voltage and frequency protection applied to plant auxiliary equipment is not applicable to the standard. Do you agree it is clear that plant aux equipment is out of scope of PRC-024? If not, please provide your rationale and a proposal

Constantin Chitescu - Ontario Power Generation Inc. - 5

Answer No

Document Name

Comment

OPG supports RSC's comments.

Likes 0

Dislikes 0

Response

Charles Yeung - Southwest Power Pool, Inc. (RTO) - 2, Group Name SRC

Answer No

Document Name

Comment

In general, we do not agree with excluding plant auxiliary equipment from the scope of the standard. Auxiliaries critical to maintain plant output must also be considered. For example, loss of primary heat transport supply to primary heat pumps in a CANDU^[1] nuclear design or fuel gas compressors in a gas plant will result in reduced plant output. The supply to other critical auxiliaries like lubricating systems, governing and excitation systems that allow the generating unit to maintain its output level also must meet PRC-024 requirements for reliability. Recognizing the difficulty in determining when auxiliary equipment will trip, it may be appropriate to provide an extended phased in implementation period to determine auxiliary equipment based trip points.^[i]

^[1] Canada Deuterium Uranium, is a Canadian pressurized heavy-water reactor design used to generate electric power. The acronym refers to its deuterium oxide (heavy water) moderator and its use of (originally, natural) uranium fuel.

^[i] ERCOT and CAISO do not agree with this recommendation and do not support this SRC response.

Likes 0

Dislikes 0

Response

Mark Gray - Edison Electric Institute - NA - Not Applicable - NA - Not Applicable

Answer No

Document Name

Comment

EEl member appreciate the efforts made by the SDT to address EEl member company concerns related to the exemption of auxiliary equipment but do not believe the language is clear. For this reason, we have provided alternative language within the Applicability section of PRC-024-3 in our response to Question 11 for SDT consideration.

Likes 0

Dislikes 0

Response

Ruida Shu - Northeast Power Coordinating Council - 1,2,3,4,5,6,7,8,9,10 - NPCC, Group Name RSC no Dominion and Con Ed

Answer

No

Document Name

Comment

Having auxiliaries trip too early on voltage or frequency which cause output to change is by definition an interaction between the plant and the power system. If the tripping auxiliaries do not affect P,Q, or Vt of the units at the plant, then they do not need to be considered.

We suggest an explicit statement be added to the Applicability section of the standard that auxiliary equipment is not applicable to the standard. We also suggest that auxiliary equipment be defined within the standard or examples of auxiliary equipment be provided within the standard.

Likes 0

Dislikes 0

Response

Sandra Shaffer - Berkshire Hathaway - PacifiCorp - 6

Answer

No

Document Name

Comment

Comments: 4.2.1.3 states, High side of the generator-connected **unit auxiliary transformer** installed on BES generating resource(s). Does this mean the aux transformer will be in scope if it is connect up stream of the high side terminals of the generator's GSU? If so, then 4.2.1.3 should read: *Aux transformers that are connected between the high side terminals of the generator's GSU and the BES Interconnection.*

The MRO NSRF suggests the SDT consider adding wording and pictures (such as PRC-025 figures 5,7, and 8) that better define aux transformers for consistency. The SDT could state something like the following in the Facilities section:

Unit auxiliary transformer(s) (UAT) that supply overall auxiliary power necessary to keep generating unit(s) online. These transformers are variably referred to as station power, unit auxiliary transformer(s) (UAT), or station service transformer(s) used to provide overall auxiliary power to the generator station when the generator is running.

Pictures

Likes 0

Dislikes 0

Response

Douglas Webb - Douglas Webb On Behalf of: Allen Klassen, Westar Energy, 6, 3, 1, 5; Bryan Taggart, Westar Energy, 6, 3, 1, 5; Derek Brown, Westar Energy, 6, 3, 1, 5; Grant Wilkerson, Westar Energy, 6, 3, 1, 5; James McBee, Great Plains Energy - Kansas City Power and Light Co., 1, 3, 6, 5; Jennifer Flandermeyer, Great Plains Energy - Kansas City Power and Light Co., 1, 3, 6, 5; John Carlson, Great Plains Energy - Kansas City Power and Light Co., 1, 3, 6, 5; Marcus Moor, Great Plains Energy - Kansas City Power and Light Co., 1, 3, 6, 5; - Douglas Webb, Group Name Westar-KCPL

Answer

No

Document Name

Comment

Comments: Kansas City Power & Light Company and Westar endorses comments submitted by EEI member companies.

Likes 0

Dislikes 0

Response

Greg Davis - Georgia Transmission Corporation - 1

Answer

No

Document Name

Comment

We believe additional clarification is required. This could be met by adding a footnote or clear language stating that the plant auxiliary equipment is out of scope of PRC-024.

Likes 0

Dislikes 0

Response

Alyssa Hubbard - SCANA - South Carolina Electric and Gas Co. - 5

Answer

No

Document Name

Comment

I am in agreement with comments submitted by Sean Bodkin-Dominion.

Likes 0

Dislikes 0

Response

Rachel Coyne - Texas Reliability Entity, Inc. - 10

Answer

No

Document Name

Comment

Texas RE inquires: where it says “all or part of the generating resource” in section 4.2.1, does a derate of a synchronous resource now fall within the applicability of the standard?

Texas RE is concerned Section 4.2 is not clear that voltage and frequency protection applied to plant auxiliary equipment is not applicable to the standard. While auxiliary transformers are not mentioned elsewhere in the standard, section 4.2.1.3 states “high side of the generator connected unit auxiliary transformer installed on BES generation resource(s).” Since this mentions auxiliary transformers, it could lead to confusion.

Additionally, Texas RE is concerned that frequency, voltage or volts per hertz protection identified under “Facilities” in section 4.2.1 is not consistent with the NERC Glossary definition of Facilities which refers to “a set of electrical equipment that operates as a single Bulk Electric System Element”. This could cause confusion with use of the term Facilities throughout the standards and implementation plans.

Furthermore, the wording “within control systems” in section 4.2.1 should be clarified because the term is very broad. For synchronous generators, is the control system limited to the plant DCS, or does it also include the excitation controls, AVR, and boiler control systems? Each of these control

systems may have frequency or voltage protective functions that could trip or derate the generator. This phrase could also unintentionally include balance of plant equipment such as forced draft fans, feed pumps, air compressors, and other equipment that was probably not intended by the SDT.

Likes 0

Dislikes 0

Response

Thomas Savin - New York Power Authority - 6

Answer

No

Document Name

Comment

Having auxiliaries trip too early on voltage or frequency which cause output to change is by definition an interaction between the plant and the power system. If the tripping auxiliaries do not affect P,Q, or Vt of the units at the plant, then they do not need to be considered. We suggest an explicit statement be added to the Applicability section of the standard that auxiliary equipment is not applicable to the standard. We also suggest that auxiliary equipment be defined within the standard or examples of auxiliary equipment be provided within the standard.

Likes 0

Dislikes 0

Response

Jodirah Green - ACES Power Marketing - 1,3,4,5,6 - MRO,WECC,Texas RE,SERC,RF, Group Name ACES Standard Collaborations

Answer

No

Document Name

Comment

We believe additional clarification is required. This could be met by adding a footnote or clear language stating that the plant auxiliary equipment is out of scope of PRC-024.

Likes 0

Dislikes 0

Response

Pamela Hunter - Southern Company - Southern Company Services, Inc. - 1,3,5,6 - SERC, Group Name Southern Company

Answer

No

Document Name

Comment

As written, the facilities section includes much more than the generator protection or generator protective relays. The phrase "all or part of the generating resource" includes all equipment. To make it clear that the applicability does not include the plant auxiliary equipment, Section 4.2 should be rewritten as follows..... 4.2.1 Frequency, voltage or volts per hertz protection, including frequency or voltage protective functions within Individual dispersed power producing resources identified in the BES Definition, Inclusion I4. The expansion of the Facilities section included in this draft of version 3 of the standard is unnecessary. Generator owners required to register as GO's already are aware of the included equipment based on the BES definition. Facilities section 4.2.1.5 expands the scope of the BES definition and should not be included. We also contend that protection systems do not initiate momentary cessation. The control system determination that a condition where "lack of control" ability is what initiates momentary cessation, a strictly control function, not a protective function. In section 4.2.1, "or momentary cessation" should be removed.

Likes 0

Dislikes 0

Response

Scott Parker - SCANA - South Carolina Electric and Gas Co. - 3

Answer

No

Document Name

Comment

I am in agreement with comments submitted by Sean Bodkin-Dominion.

Likes 0

Dislikes 0

Response

Richard Jackson - U.S. Bureau of Reclamation - 1

Answer

No

Document Name

Comment

Reclamation recommends the SDT strive to draft the clearest possible standards. It would be more clear that plant aux equipment is out of scope of PRC-024 if it was specifically stated as being excluded.

Likes 0

Dislikes 0

Response

Tom Hanzlik - SCANA - South Carolina Electric and Gas Co. - 1

Answer	No
Document Name	
Comment	
I agree with the comments submitted by Sean Bodkin-Dominion	
Likes 0	
Dislikes 0	
Response	
Jeremy Voll - Basin Electric Power Cooperative - 1,3,5,6	
Answer	No
Document Name	
Comment	
Support the MRO NSRF Comments	
Likes 0	
Dislikes 0	
Response	
Don Schmit - Nebraska Public Power District - 1,3,5	
Answer	No
Document Name	
Comment	
NPPD supports the comments submitted by the MRO NSRF.	
Likes 0	
Dislikes 0	
Response	
Scott Berry - Scott Berry On Behalf of: Jack Alvey, Indiana Municipal Power Agency, 1, 4; - Scott Berry	
Answer	No
Document Name	

Comment

If plant auxiliary equipment is not applicable to the standard, it should be clearly stated in the standard instead of saying it is not applicable because it is not listed under Facilities. However, it might not be clear what is all included in the category of auxiliary equipment. What one plant views equipment to be auxiliary may not be the same for other generating plants. By making an attempt to only include certain equipment and by not stating the status of specific other equipment (i.e. auxiliary equipment) it may not be clear to an entity or an auditor if the other equipment is included, especially when the included equipment terms are vague and might be more encompassing than intended by the SDT.

In addition, during a frequency or voltage event, auxiliary equipment will likely trip offline and cause the generation to trip offline. If this happens in the no trip zone, the standard does not address if this would be allowed or not.

Likes	0
-------	---

Dislikes	0
----------	---

Response

Alex Chua - Pacific Gas and Electric Company - 1,3,5

Answer	No
---------------	----

Document Name	
----------------------	--

Comment

It is not. Examples of equipment in scope should be detailed in a few examples such as those found in the application guideline for PRC-025-2

Likes	0
-------	---

Dislikes	0
----------	---

Response

Dana Klem - MRO - 1,2,3,4,5,6 - MRO, Group Name MRO NSRF

Answer	No
---------------	----

Document Name	Project 2018-04 PRC-024-3 NSRFI Comment Form 05-29-2019.docx
----------------------	--

Comment

4.2.1.3 states, High side of the generator-connected **unit auxiliary transformer** installed on BES generating resource(s). Does this mean the aux transformer will be in scope if it is connect up stream of the high side terminals of the generator's GSU? If so, then 4.2.1.3 should read: *Aux transformers that are connected between the high side terminals of the generator's GSU and the BES Interconnection.*

The MRO NSRF suggests the SDT consider adding wording and pictures (such as PRC-025 figures 5,7, and 8) that better define aux transformers for consistency. The SDT could state something like the following in the Facilities section:

Unit auxiliary transformer(s) (UAT) that supply overall auxiliary power necessary to keep generating unit(s) online. These transformers are variably referred to as station power, unit auxiliary transformer(s) (UAT), or station service transformer(s) used to provide overall auxiliary power to the generator station when the generator is running.

See illustrations in attachment.

Likes 0

Dislikes 0

Response

Lana Smith - San Miguel Electric Cooperative, Inc. - 5

Answer

No

Document Name

Comment

We believe additional clarification is required. This could be met by adding a footnote or clear language stating that the plant auxiliary equipment is out of scope of PRC-024.

Likes 0

Dislikes 0

Response

Neil Swearingen - Salt River Project - 1,3,5,6 - WECC

Answer

No

Document Name

Comment

There does not appear to be a threshold for an element to be applicable under section 4.2.1.5. Since the definition of Element is vague (Any electrical device with terminals that may be connected to other electrical devices...) and there is no generation level specified to trigger the inclusion of an Element per section 4.2.1.5, additional clarity is needed. The BES Definition Inclusion 4 is referenced in section 4.2.1.6, so it may be interpreted that the aggregate 75 MVA threshold should also be used for section 4.2.1.5, but it is not clear. SRP recommends providing more specific criteria for applicability under section 4.2.1.5.

Likes 0

Dislikes 0

Response

Dennis Chastain - Tennessee Valley Authority - 1,3,5,6 - SERC

Answer	No
Document Name	
Comment	
<p>Please provide a definition for "generating resource" as used in the document. Would a reactor coolant pump motor or a boiler feed pump motor be considered one as they are both "resources" that are required for generation? If not, how can we assure that an auditor won't think so? Without this, we don't see how this answers item "f" in the SAR Project Scope to "Clarify that plant auxiliary equipment protection systems are not subject to the requirements of PRC-024".</p>	
Likes	0
Dislikes	0
Response	
<p>Sean Bodkin - Dominion - Dominion Resources, Inc. - 6, Group Name Dominion</p>	
Answer	No
Document Name	
Comment	
<p>Dominion Energy does not agree that proposed Reliability Standard PRC-024-3 clearly exempts plant auxiliary equipment from the requirements of this standard. While there is some language contained within the Applicability section (4.2.1.3) of proposed Reliability Standard PRC-024-3, we believe it is insufficient to ensure GO's plant auxiliary equipment is exempt from the requirements of this proposed Reliability Standard.</p> <p>Our proposal to address this issue and other concerns within the Applicability section of PRC-024-3 are provided in our response to Question 11.</p>	
Likes	1
Dislikes	0
Response	
<p>Glen Farmer - Avista - Avista Corporation - 5</p>	
Answer	No
Document Name	
Comment	
<p>Agree with EEI.</p>	
Likes	0
Dislikes	0

Response	
Leonard Kula - Independent Electricity System Operator - 2	
Answer	No
Document Name	
Comment	
<p>We do not agree with excluding plant auxiliary equipment from the scope of the standard. Auxiliaries critical to maintain plant output must also be considered. For example, loss of primary heat transport supply to primary heat pumps in a CANDU nuclear design or fuel gas compressors in a gas plant will result in reduced plant output. The supply to other critical auxiliaries like lubricating systems, governing and excitation systems that allow the generating unit to maintain its output level also must meet PRC-024 requirements for reliability.</p> <p>We would like to better understand the rationale for not applying plant auxiliary equipment to the standard. Having auxiliaries trip too early on voltage or frequency which cause output to change is by definition an interaction between the plant and the power system. If the tripping auxiliaries do not affect P,Q, or Vt of the units at the plant, then we agree with they do not need to be considered.</p>	
Likes	0
Dislikes	0
Response	
Thomas Foltz - AEP - 5	
Answer	No
Document Name	
Comment	
<p>It is AEP's conclusion that it is not clear that voltage and frequency protection applied to plant auxiliary equipment is not applicable to the standard, due to the proposed inclusion of high side of the generator-connected auxiliary transformer. This could result in an expansion of scope that is not intended by the revisions proposed by the Standards Drafting Team. In addition, more concerning than whether or not plant auxiliary equipment is clearly out of scope of PRC-024, is the inclusion of "High side of the generator-connected unit auxiliary transformer installed on BES generating resource(s)" within 4.2.1.3. We find no technical justification for its inclusion. AEP objects to this inclusion and seeks clarification and justification for proposing it.</p>	
Likes	0
Dislikes	0
Response	
RoLynda Shumpert - SCANA - South Carolina Electric and Gas Co. - 1,3,5,6 - SERC	
Answer	No

Document Name	
Comment	
Likes 0	
Dislikes 0	
Response	
Armin Klusman - CenterPoint Energy Houston Electric, LLC - 1 - Texas RE	
Answer	Yes
Document Name	
Comment	
CenterPoint Energy Houston Electric, LLC supports the comments submitted by the Edison Electric Institute.	
Likes 0	
Dislikes 0	
Response	
Chris Scanlon - Exelon - 1	
Answer	Yes
Document Name	
Comment	
<p>Exelon agrees that the draft Standard has revised the Applicability to exclude auxiliary equipment from scope; however, Exelon suggests adding further clarification to ensure that there is no potential ambiguity. This could be accomplished in a footnote to the applicability section or noted elsewhere in the Standard. Suggested language is as follows:</p> <p>“Generator trips resulting from auxiliary equipment voltage and frequency protection systems (either directly or via tripping signals) are not included in the scope of PRC-024-3”</p> <p>Exelon, Segments 1, 3, 5, 6</p>	
Likes 0	
Dislikes 0	
Response	
Ozan Ferrin - Tacoma Public Utilities (Tacoma, WA) - 5	

Answer	Yes
Document Name	
Comment	
However, Tacoma Power believes there is still room for improving this clarification	
Likes 0	
Dislikes 0	
Response	
Aaron Cavanaugh - Bonneville Power Administration - 1,3,5,6 - WECC	
Answer	Yes
Document Name	
Comment	
None	
Likes 0	
Dislikes 0	
Response	
Jennifer Hohenshilt - Talen Energy Marketing, LLC - 6	
Answer	Yes
Document Name	
Comment	
Yes, we agree that plant auxiliary equipment should be excluded. the term, "Bulk Elcetric System (BES) generating resource(s)," in para. 4.2.1.1, combined with, "all or part of," in para. 4.2.1, could undo this exclusion, however, especially when considering our response to question 11 below. The proposed new standard could be interpreted as forbidding drop-out of motor control center contractors, for example.	
Likes 0	
Dislikes 0	
Response	
Matthew McMillan - Talen Generation, LLC - 5	
Answer	Yes

Document Name	
Comment	
<p>Yes, we agree that plant auxiliary equipment should be excluded. The term, "Bulk Electric System (BES) generating resource(s)," in para. 4.2.1.1, combined with, "all or part of," in para. 4.2.1, could undo this exclusion, however, especially when considering our response to question 11 below. The proposed new standard could be interpreted as forbidding drop-out of motor control center contactors, for example.</p>	
Likes 0	
Dislikes 0	
Response	
Karie Barczak - DTE Energy - Detroit Edison Company - 3, Group Name DTE Energy - DTE Electric	
Answer	Yes
Document Name	
Comment	
<p>We recommend a footnote that says something to the effect of:</p> <p>"Generator trips resulting from auxiliary equipment protection systems (either directly or via tripping signals) are not included in the scope of PRC-024-3"</p>	
Likes 0	
Dislikes 0	
Response	
Bradley Collard - SunPower - 5	
Answer	Yes
Document Name	
Comment	
Likes 0	
Dislikes 0	
Response	
Leo Bernier - AES - AES Corporation - 5	
Answer	Yes

Document Name	
Comment	
Likes 0	
Dislikes 0	
Response	
Bette White - AES - Indianapolis Power and Light Co. - 3	
Answer	Yes
Document Name	
Comment	
Likes 0	
Dislikes 0	
Response	
Jamie Monette - Allete - Minnesota Power, Inc. - 1	
Answer	Yes
Document Name	
Comment	
Likes 0	
Dislikes 0	
Response	
Brandon McCormick - Brandon McCormick On Behalf of: Carol Chinn, Florida Municipal Power Agency, 6, 4, 3, 5; Chris Gowder, Florida Municipal Power Agency, 6, 4, 3, 5; Darko Kovac, Gainesville Regional Utilities, 1, 5, 3; David Owens, Gainesville Regional Utilities, 1, 5, 3; Don Cuevas, Beaches Energy Services, 1, 3; Joe McKinney, Florida Municipal Power Agency, 6, 4, 3, 5; Neville Bowen, Ocala Utility Services, 3; Nick Batty, Keys Energy Services, 4; Richard Montgomery, Florida Municipal Power Agency, 6, 4, 3, 5; Steven Lancaster, Beaches Energy Services, 1, 3; Tom Reedy, Florida Municipal Power Pool, 6; - Brandon McCormick, Group Name FMPA	
Answer	Yes
Document Name	
Comment	

Likes 0

Dislikes 0

Response

Anton Vu - Los Angeles Department of Water and Power - 6

Answer Yes

Document Name

Comment

Likes 0

Dislikes 0

Response

Davis Jelusich - Public Utility District No. 1 of Chelan County - 6

Answer Yes

Document Name

Comment

Likes 0

Dislikes 0

Response

Nick Batty - Keys Energy Services - NA - Not Applicable - FRCC

Answer Yes

Document Name

Comment

Likes 0

Dislikes 0

Response

Scott Langston - Tallahassee Electric (City of Tallahassee, FL) - 1

Answer	Yes
Document Name	
Comment	
Likes 0	
Dislikes 0	
Response	
Allen Schriver - NextEra Energy - 5	
Answer	Yes
Document Name	
Comment	
Likes 0	
Dislikes 0	
Response	
Shirley Mathew - Austin Energy - 5	
Answer	Yes
Document Name	
Comment	
Likes 1	Austin Energy, 3, Preston W. Dwayne
Dislikes 0	
Response	
Andrew Gallo - Austin Energy - 1,3,4,5,6	
Answer	Yes
Document Name	
Comment	
Likes 0	

Dislikes 0

Response

Jesus Sammy Alcaraz - Imperial Irrigation District - 1

Answer

Yes

Document Name

Comment

Likes 0

Dislikes 0

Response

Kim Thomas - Duke Energy - 1,3,5,6 - FRCC,SERC,RF, Group Name Duke Energy

Answer

Yes

Document Name

Comment

Likes 0

Dislikes 0

Response

Matthew Nutsch - Seattle City Light - 1,3,4,5,6 - WECC

Answer

Yes

Document Name

Comment

Likes 0

Dislikes 0

Response

Steven Rueckert - Western Electricity Coordinating Council - 10

Answer

Yes

Document Name	
Comment	
Likes 0	
Dislikes 0	
Response	
Michelle Amarantos - APS - Arizona Public Service Co. - 1	
Answer	Yes
Document Name	
Comment	
Likes 0	
Dislikes 0	
Response	
David Jendras - Ameren - Ameren Services - 3	
Answer	Yes
Document Name	
Comment	
Likes 0	
Dislikes 0	
Response	
Kayleigh Wilkerson - Lincoln Electric System - 5, Group Name Lincoln Electric System	
Answer	Yes
Document Name	
Comment	
Likes 0	
Dislikes 0	

Response

Amy Casuscelli - Amy Casuscelli On Behalf of: Gerry Huitt, Xcel Energy, Inc., 3, 1, 5; - Amy Casuscelli

Answer Yes

Document Name

Comment

Likes 0

Dislikes 0

Response

Eric Smith - NaturEner USA, LLC - 5

Answer Yes

Document Name

Comment

Likes 0

Dislikes 0

Response

Chris Wagner - Santee Cooper - 1, Group Name Santee Cooper

Answer Yes

Document Name

Comment

Likes 0

Dislikes 0

Response

Jeanne Kurzynowski - CMS Energy - Consumers Energy Company - 1,3,4,5 - RF

Answer Yes

Document Name

Comment

Likes 0

Dislikes 0

Response

Maryanne Darling-Reich - Black Hills Corporation - 1,3,5,6 - MRO,WECC

Answer

Yes

Document Name

Comment

Likes 0

Dislikes 0

Response

Kagen DelRio - Kagen DelRio On Behalf of: doug white, North Carolina Electric Membership Corporation, 4, 3, 5; John Lemire, North Carolina Electric Membership Corporation, 4, 3, 5; Robert Beadle, North Carolina Electric Membership Corporation, 4, 3, 5; - Kagen DelRio

Answer

Document Name

Comment

NCEMC supports the comments submitted by ACES

Likes 0

Dislikes 0

Response

Richard Vine - California ISO - 2

Answer

Document Name

Comment

The California ISO supports the comments as submitted by the ISO/RTO Council Standards Review Committee (SRC)

Likes 0

Dislikes 0

Response

Todd Bennett - Associated Electric Cooperative, Inc. - 3, Group Name AECI

Answer

Document Name

Comment

AECI supports the comments submitted by ACES

Likes 0

Dislikes 0

Response

7. The SDT made several clarifying changes to the figures and tables (outlined in the SAR) to improve readability and eliminate confusion addressed in the SAR, including: (i) labeling the area outside the “No Trip Zone” as the “May Trip Zone;” (ii) removal of “ride-through” language; (iii) addition of “Minimum Time;” (iv) replacement of “instantaneous” with “0.10” seconds; and (v) clarifying modifications to the Voltage Boundary Clarifications. Do you agree with these modifications? If not, please recommend alternative solution(s)

Dan Roethemeyer - Vistra Energy - 5

Answer No

Document Name

Comment

Please clarify why a change is being made from instantaneous to .10 seconds. They will likely require changes to protection systems and generator owners have likely already completed many reviews of their frequency settings and adding the .10 second requirement could require additional time and resources to review again. Recommend leaving as instantaneous.

Likes 0

Dislikes 0

Response

Leonard Kula - Independent Electricity System Operator - 2

Answer No

Document Name

Comment

Most power system analysis is done using a positive-sequence representation on the network. By updating the standard to specify the use of positive sequence voltage will make the standard more practical.

We propose that the RMS signal should be clarified that it pertains to positive-sequence. We propose that Item 5 in the section “Voltage Boundary Clarifications – Eastern, Western, and ERCOT Interconnections, Boundary Details [page 21 of 25] be consistent with that for the Quebec Interconnection and be replaced with:

5. Voltages in the boundaries assume positive-sequence values.

instead of the proposed “Voltages in the boundaries assume RMS fundamental frequency phase-to-ground or phase-to-phase voltage”

Likes 0

Dislikes 0

Response

Jeanne Kurzynowski - CMS Energy - Consumers Energy Company - 1,3,4,5 - RF

Answer No

Document Name	
Comment	
Changes to the curves and tables are very helpful.	
In Attachment 2, Voltage Boundary Clarifications, how does item 2. "The boundaries apply to voltage excursions regardless of the type of initiating event" provide clarification? I understand the curves were developed based on event simulations, but for analysis, the Entity is simply plotting the relay curves using assumed loading conditions to assure these curves and thus tripping are not in the "No Trip Zone". If this statement is attempting to tell the Entity that running a series of event simulations is not enough to ensure compliance, please add more information to the clarification.	
In Attachment 2, Voltage Boundary Clarifications, item 3 is correct, but is redundant as Table 1 already includes the text "Minimum Time (sec). Should item 3 be removed from the document?"	
In Attachment 2, Voltage Boundary Clarifications, item 4 states that the boundary can be adjusted in proportion to frequency. Does this eliminate the possibility of leaving the boundary alone and evaluating the volts per hertz relay at 60Hz?	
In Attachment 2, Voltage Boundary Clarifications, item 6 is correct, but is redundant as Table 1 indicates no limitation in voltage setting after 4 seconds. Should item 6 be removed from the document.	

Likes 0	
Dislikes 0	

Response

Glen Farmer - Avista - Avista Corporation - 5

Answer	No
---------------	----

Document Name

Comment

agree with EEI.

Likes 0	
Dislikes 0	

Response

Sean Bodkin - Dominion - Dominion Resources, Inc. - 6, Group Name Dominion

Answer	No
---------------	----

Document Name

Comment

In general, Dominion Energy supports most of the clarifying changes made to the figures and tables contained in the proposed Reliability Standard PRC-024-3; however, it appears the boundaries curves depicted assume a system frequency is of 60 Hertz. When evaluating volts per hertz

Volts/Hertz protection, you may adjust the magnitude of the high voltage curve boundary which can be adjusted in proportion to deviations of frequency below 60 Hertz. Dominion Energy suggests that the SDT review the curves and make appropriate modifications.

Likes 1 SCANA - South Carolina Electric and Gas Co., 1,3,5,6, Shumpert RoLynda

Dislikes 0

Response

David Jendras - Ameren - Ameren Services - 3

Answer No

Document Name

Comment

If we have a frequency trip point that is right on the boundary i.e trip freq. at 0.1 seconds, how would this be ruled? Is the relay in compliance or should it be reset so that it is away from the boundary. The comment "Not Including the Lines" was removed from Attachment 1 Figure 1. If the intent is now to include the lines (i.e. the "No Trip Zone" includes the boundary) then rather than remove "Not Including Lines" it would be better to change to "Including the lines".

Likes 0

Dislikes 0

Response

Steven Rueckert - Western Electricity Coordinating Council - 10

Answer No

Document Name

Comment

WECC questions the change from "Instantaneous Trip" to 0.10 seconds on the Frequency Boundary Data Points table. Is the 0.10 seconds an intentional delay that must be set on the protection equipment or is it the time that the resource must stay connected. If it is an intentional delay, WECC believes it should be 0.00 seconds. As noted in the Gaps Whitepaper frequency is calculate on a "sliding window" which inherently implements a time delay of 100 ms (6-Cycles). The proposed change stems from an erroneous "perceived system frequency below 57 Hz due inverter-based resources using the Phase Locked Loop logic indicating a near instantaneous frequency during the transient/distorted waveform period as less than 57 Hz" and introduces additional time delay, 6-cycle "sliding window" plus a relay time of 100 ms exposing the units to an effective 12-cycle event. Additionally, this delay could burden industry with unnecessary and time-consuming protection system setting changes to address an erroneous frequency calculation by inverter-based resources. If this is an intentional time delay that must be set, synchronous machine owners may have to reset their protection system setting if it is based on the current version of the standard.

WECC disagrees with the change on the Voltage Boundary Data Points table. Like the frequency tables, where "continuous operation" is specified for frequencies within a certain boundary, WECC believes that "continuous operation" should be specified for voltages between 1.10 pu and 0.90 pu, rather than 4.00 seconds. Why does the no-trip zone end at four seconds? Resource owners could misinterpret this to mean resources may trip or go into momentary cessation after four seconds of operation between 1.10 pu and 0.90 pu. This should also be revised in the Voltage Boundary Clarifications section.

Likes 2	Tarantino Joe On Behalf of: Arthur Starkovich, Sacramento Municipal Utility District, 4, 1, 5, 6, ; JEA, 3, Baker Garry
Dislikes 0	
Response	
Matthew Nutsch - Seattle City Light - 1,3,4,5,6 - WECC	
Answer	No
Document Name	
Comment	
<p>The premise of changing the instantaneous trip points to a minimum delay of .10 sec in Attachment 1 is flawed. Reading the SAR, it is saying that frequency cannot and should not be measured or calculated using an instantaneously sampled value, and that the minimum window that should be used is 6 cycles (.1 seconds). While I agree with this statement, I think that it is flawed to add this delay and make the assumption that the relays are not already operating with an internal delay to calculate frequency and rms voltage. The microprocessor based relay is already adding a delay to sample and calculate frequency over a defined window. By adding .1 seconds, as this new revision is proposing, you are actually adding a time delay on top of a time delay that already exists internally during the calculation of frequency. Frequency and RMS are never measured 'instantaneously', and adding a time delay would not fix a relay that is measuring these signals incorrectly.</p>	
Likes 0	
Dislikes 0	
Response	
Faz Kasraie - Seattle City Light - 5	
Answer	No
Document Name	
Comment	
<p>Seattle City Light has voted No on this standard due to discrepancies with adding an additional time delay to the frequency settings of the protective relays. Seattle City Light has provided full comments on the Project 2018-04 Modifications to PRC-024-2 PRC-024-3 (Draft 1) form explaining our position.</p>	
Likes 0	
Dislikes 0	
Response	
Scott Berry - Scott Berry On Behalf of: Jack Alvey, Indiana Municipal Power Agency, 1, 4; - Scott Berry	
Answer	No
Document Name	

Comment

There is no need to replace instantaneous with 0.10 seconds. If there is a significant event on the system above or below the appropriate set points, the minimum set point should be instantaneous.

Likes 0

Dislikes 0

Response**Don Schmit - Nebraska Public Power District - 1,3,5**

Answer

No

Document Name

Comment

NPPD supports the comments submitted by the LPPC (Large Public Power Council)

Likes 0

Dislikes 0

Response**Jesus Sammy Alcaraz - Imperial Irrigation District - 1**

Answer

No

Document Name

Comment

IID is recommedning that the relay has a minimum delay of 0.08 seconds and adding 0.1 the total time delay will be 0.18 seconds.

Likes 0

Dislikes 0

Response**Tom Hanzlik - SCANA - South Carolina Electric and Gas Co. - 1**

Answer

No

Document Name

Comment

I agree with the comments submitted by Sean Bodkin-Dominion

Likes 0

Dislikes 0

Response

Daniel Mason - Portland General Electric Co. - 6

Answer

No

Document Name

Comment

Recommend that PRC-024 – Attachment 2 Voltage Boundary Data Points table should include high and low voltage limits for the “Continuous operation” zone, as was done for the Quebec Voltage Boundary Data Points and all Frequency Boundary Data Points.

Likes 0

Dislikes 0

Response

Andrew Gallo - Austin Energy - 1,3,4,5,6

Answer

No

Document Name

Comment

Addition of intentional delay for thermal units for the low and high frequency ranges are unnecessary. There are inherent time delays associated with an instantaneous protection system tripping scheme that is close to 6-8 cycles (detection time + computation time+ tripping signal transmit time + interrupting device opening time). Including the ‘minimum time delay’ creates additional burden on the synchronous generator owners to revise the settings and test those settings without additional benefits to the reliability of the BES. The proposed revision will be a compliance burden that does not add reliability benefits.

Likes 0

Dislikes 0

Response

Shirley Mathew - Austin Energy - 5

Answer

No

Document Name

Comment

Addition of intentional delay for thermal units for the low and high frequency ranges are unnecessary. There are inherent time delays associated with an instantaneous protection system tripping scheme which is close to 6-8 cycles (detection time + computation time+ tripping signal transmit time + interrupting device opening time). Including the 'minimum time delay' creates additional burden on the synchronous generator owners to revise the settings and testing those settings without additional benefits to the system. This will be a compliance burden and does not add to reliability benefits.

Likes 1

Austin Energy, 3, Preston W. Dwayne

Dislikes 0

Response**Scott Parker - SCANA - South Carolina Electric and Gas Co. - 3****Answer**

No

Document Name**Comment**

I am in agreement with comments submitted by Sean Bodkin-Dominion.

Likes 0

Dislikes 0

Response**Chris Scanlon - Exelon - 1****Answer**

No

Document Name**Comment**

The revision to Figure 1 to label the area as a "May Trip Zone" is confusing. Exelon suggests explaining that if tripping, trip setpoint(s) need to be set to operate "on or below" the appropriate curve in lieu of labeling the region outside as a "May Trip Zone". This also will provide clarification for settings on the curve are considered compliant.

Exelon, Segments 1, 3, 5, 6

Likes 0

Dislikes 0

Response**Scott Langston - Tallahassee Electric (City of Tallahassee, FL) - 1**

Answer	No
Document Name	
Comment	
<p>It may be clearer that the "May Trip Zone" be shaded. Also, the standard should continue to explain that the lines are not included in the trip zone in words. The boundary details Note 1, should include the verbiage "...nominal operating voltage at the high-side of the GSU or collector transformer" in order to be consistent and absolutely clear. Boundary Details, Note 4 may be better explained with an example.</p>	
Likes 0	
Dislikes 0	
Response	
Pamela Hunter - Southern Company - Southern Company Services, Inc. - 1,3,5,6 - SERC, Group Name Southern Company	
Answer	No
Document Name	
Comment	
<p>Do not completely agree. The 0.1 second delay proposal is included to address an incorrect frequency calculation method used by inverter manufacturers. With a correction to the frequency calculation method already made, it is not clear why this change is needed. Also, the wording of the purpose, facilities, and requirements effectively add plant "ride-through" obligations to the GO and the TO rather than addressing the protection system settings solely. To better express the intention of the "No Trip Zone" in Attachment 2 and 2a, the phrase "...represent the minimum time durations allowed..." in Note 3 of the Voltage Boundary Clarifications section should be "...represent the minimum time duration required for no trip from the protection settings"</p>	
Likes 0	
Dislikes 0	
Response	
Alyssa Hubbard - SCANA - South Carolina Electric and Gas Co. - 5	
Answer	No
Document Name	
Comment	
<p>I am in agreement with comments submitted by Sean Bodkin-Dominion.</p>	
Likes 0	
Dislikes 0	
Response	

Douglas Webb - Douglas Webb On Behalf of: Allen Klassen, Westar Energy, 6, 3, 1, 5; Bryan Taggart, Westar Energy, 6, 3, 1, 5; Derek Brown, Westar Energy, 6, 3, 1, 5; Grant Wilkerson, Westar Energy, 6, 3, 1, 5; James McBee, Great Plains Energy - Kansas City Power and Light Co., 1, 3, 6, 5; Jennifer Flandermeyer, Great Plains Energy - Kansas City Power and Light Co., 1, 3, 6, 5; John Carlson, Great Plains Energy - Kansas City Power and Light Co., 1, 3, 6, 5; Marcus Moor, Great Plains Energy - Kansas City Power and Light Co., 1, 3, 6, 5; - Douglas Webb, Group Name Westar-KCPL

Answer No

Document Name

Comment

Comments: Kansas City Power & Light Company and Westar endorses comments submitted by EEI member companies.

Likes 0

Dislikes 0

Response

Ruida Shu - Northeast Power Coordinating Council - 1,2,3,4,5,6,7,8,9,10 - NPCC, Group Name RSC no Dominion and Con Ed

Answer No

Document Name

Comment

Most power system analysis is done using a positive-sequence representation on the network. By updating the standard to specify the use of positive sequence voltage will make the standard more practical.

We propose that the RMS signal should be clarified that it pertains to positive-sequence. We propose that Item 5 in the section "Voltage Boundary Clarifications – Eastern, Western, and ERCOT Interconnections, Boundary Details [page 21 of 25] be consistent with that for the Quebec Interconnection and be replaced with:

5. *Voltages in the boundaries assume positive-sequence values.*

instead of the proposed "Voltages in the boundaries assume RMS fundamental frequency phase-to-ground or phase-to-phase voltage"

Likes 0

Dislikes 0

Response

Mark Gray - Edison Electric Institute - NA - Not Applicable - NA - Not Applicable

Answer No

Document Name	
Comment	
<p>In general, EEI member companies support most of the clarifying changes made to the figures and tables contained in the proposed Reliability Standard PRC-024-3; however, the changes made to the tables supporting the various graphs contained in Attachment 1 (Frequency No Trip Boundary by Interconnection), as it relates to the change from “Instantaneous trip” to “0.10” seconds may create confusion. While we understand and support what the SDT has attempted to do (i.e., removal of the instantaneous trip label from the table), , we believe that the clarifying changes may be interpreted to mean an additional 0.10 second (i.e., approx. 6 cycle) delay is now required after a measurement of frequency greater than 66Hz or below 55.5Hz has been measured. For this reason, we suggest leaving the Instantaneous trip language within the underlying tables and simply adding a note to explain the 100ms filtering/time window is needed to accurately measure frequency and that no intentional time delay is required. This change would more clearly convey the intent and retain consistency between the frequency tables and the voltage table in Attachment 2, as well as, ensure that both traditional resources and inverter-based resources consistently operate and understand the intent.</p>	
Likes	0
Dislikes	0
Response	
Armin Klusman - CenterPoint Energy Houston Electric, LLC - 1 - Texas RE	
Answer	No
Document Name	
Comment	
<p>CenterPoint Energy Houston Electric, LLC supports the comments submitted by the Edison Electric Institute.</p>	
Likes	0
Dislikes	0
Response	
Charles Yeung - Southwest Power Pool, Inc. (RTO) - 2, Group Name SRC	
Answer	No
Document Name	
Comment	
<p>We suggest changing the “May Trip Zone” to an “Equipment Limitation Zone” to ensure that the generator will remain connected to the system for the longest time allowed by the equipment capabilities that are outside the “No Trip Zone”. In addition, the SDT should consider and specify what is required after four seconds. As currently drafted, the Voltage No-Trip Boundary chart on page 19 ends at four seconds. Transient conditions may last longer than four seconds. What should the requirement be after four seconds, and for how long? There should be some certainty beyond four seconds – what is continuous rating (i.e.- the Quebec chart)?</p>	

Since most power system analysis is done using a positive-sequence representation on the network, updating the standard to specify the use of positive sequence voltage will make the standard more practical.

We propose that the RMS signal should be clarified that it pertains to positive-sequence. We propose that Item 5 in the section “Voltage Boundary Clarifications – Eastern, Western, and ERCOT Interconnections, Boundary Details [page 21 of 25] be consistent with that for the Quebec Interconnection and be replaced with:

“5. Voltages in the boundaries assume positive-sequence values.”

Rather than the proposed “Voltages in the boundaries assume RMS fundamental frequency phase-to-ground or phase-to-phase voltage”

If the language is to remain as is then please correct a typo in the Eastern Interconnection Boundaries chart on page 15—“May Trip” Zone should be “May Trip Zone” in order to be consistent with the use of the phrase elsewhere in the proposed Standard.

Likes 0

Dislikes 0

Response

Constantin Chitescu - Ontario Power Generation Inc. - 5

Answer

No

Document Name

Comment

OPG supports RSC's comments.

Likes 0

Dislikes 0

Response

Bradley Collard - SunPower - 5

Answer

No

Document Name

Comment

SunPower believes the SDT may want to revisit the frequency and voltage protective relay functions found in their documentation. Removing the term “Instantaneous trip” with “0.10” will require many protective relay functions to be changed on relays across all Interconnections that are not the real issue at the core of the SAR.

Also, provide language that allows instantaneous tripping of inverter control protection if any protection relay has operated separating the inverter from the system.

Likes 0

Dislikes 0

Response

RoLynda Shumpert - SCANA - South Carolina Electric and Gas Co. - 1,3,5,6 - SERC

Answer No

Document Name

Comment

Likes 0

Dislikes 0

Response

Karie Barczak - DTE Energy - Detroit Edison Company - 3, Group Name DTE Energy - DTE Electric

Answer Yes

Document Name

Comment

The revision to Figure 1 to label the area as a “May Trip Zone” is confusing. Suggest explaining that trips need to be set to operate “on or below” the appropriate curve in lieu of labeling the region outside as a “May Trip Zone”. This also will provide clarification for settings on the curve are considered compliant.

Likes 0

Dislikes 0

Response

Aaron Cavanaugh - Bonneville Power Administration - 1,3,5,6 - WECC

Answer Yes

Document Name

Comment	
None	
Likes 0	
Dislikes 0	
Response	
Amy Casuscelli - Amy Casuscelli On Behalf of: Gerry Huitt, Xcel Energy, Inc., 3, 1, 5; - Amy Casuscelli	
Answer	Yes
Document Name	
Comment	
<p>We also submit the following modifications to Chart Attachment 1:</p> <p>Y axis (Time) should continue below 0.1 second down to 0 seconds. The drafting team is aware of this shortcoming due to the logarithmic chart. Consider using a chart with a discontinuity symbol to allow for an axis break on the Y axis so that a portion of the chart ranges from 0 to 0.1 second and a portion ranges from 0.1 to 10,000 seconds. The associated table should reflect the changes to the chart and should clarify acceptable trips below 0.1 seconds.</p>	
Likes 1	JEA, 3, Baker Garry
Dislikes 0	
Response	
Davis Jelusich - Public Utility District No. 1 of Chelan County - 6	
Answer	Yes
Document Name	
Comment	
<p>It may be beneficial for the Voltage No-Trip Boundary to show a vertical line at 4 seconds to indicate the end of the “No Trip Zone” of the Voltage No-Trip Boundary – Eastern, Western, and ERCOT Interconnections. This change would align with bullet point 6 in the Voltage Boundary Clarifications – Eastern, Western, and ERCOT Interconnections.</p> <p>Regarding the implementation period associated with the proposed 0.1-second time delay, given the current instantaneous trip has been in place for several years with no identified impact on the bulk power system it is suggested that the SDT consider a longer implementation period for any necessary changes that are less than the proposed time delay of 0.1-seconds. Since the instantaneous settings has been in place and implemented for several years (20+ years) the proposed 18-month period may be problematic for some as it requires changes to the trip settings and any necessary testing associated with that proposed change.</p>	

Likes 0

Dislikes 0

Response

Maryanne Darling-Reich - Black Hills Corporation - 1,3,5,6 - MRO,WECC

Answer Yes

Document Name

Comment

Likes 0

Dislikes 0

Response

Matthew McMillan - Talen Generation, LLC - 5

Answer Yes

Document Name

Comment

Likes 0

Dislikes 0

Response

Jennifer Hohenshilt - Talen Energy Marketing, LLC - 6

Answer Yes

Document Name

Comment

Likes 0

Dislikes 0

Response

Thomas Foltz - AEP - 5

Answer	Yes
Document Name	
Comment	
Likes 0	
Dislikes 0	
Response	
Chris Wagner - Santee Cooper - 1, Group Name Santee Cooper	
Answer	Yes
Document Name	
Comment	
Likes 0	
Dislikes 0	
Response	
Dennis Chastain - Tennessee Valley Authority - 1,3,5,6 - SERC	
Answer	Yes
Document Name	
Comment	
Likes 0	
Dislikes 0	
Response	
Eric Smith - NaturEner USA, LLC - 5	
Answer	Yes
Document Name	
Comment	
Likes 0	

Dislikes 0

Response

Kayleigh Wilkerson - Lincoln Electric System - 5, Group Name Lincoln Electric System

Answer Yes

Document Name

Comment

Likes 0

Dislikes 0

Response

Neil Swearingen - Salt River Project - 1,3,5,6 - WECC

Answer Yes

Document Name

Comment

Likes 0

Dislikes 0

Response

Lana Smith - San Miguel Electric Cooperative, Inc. - 5

Answer Yes

Document Name

Comment

Likes 0

Dislikes 0

Response

Ozan Ferrin - Tacoma Public Utilities (Tacoma, WA) - 5

Answer Yes

Document Name	
Comment	
Likes 0	
Dislikes 0	
Response	
Michelle Amarantos - APS - Arizona Public Service Co. - 1	
Answer	Yes
Document Name	
Comment	
Likes 0	
Dislikes 0	
Response	
Dana Klem - MRO - 1,2,3,4,5,6 - MRO, Group Name MRO NSRF	
Answer	Yes
Document Name	
Comment	
Likes 0	
Dislikes 0	
Response	
Alex Chua - Pacific Gas and Electric Company - 1,3,5	
Answer	Yes
Document Name	
Comment	
Likes 0	
Dislikes 0	

Response

Kim Thomas - Duke Energy - 1,3,5,6 - FRCC,SERC,RF, Group Name Duke Energy

Answer Yes

Document Name

Comment

Likes 0

Dislikes 0

Response

Jeremy Voll - Basin Electric Power Cooperative - 1,3,5,6

Answer Yes

Document Name

Comment

Likes 0

Dislikes 0

Response

Richard Jackson - U.S. Bureau of Reclamation - 1

Answer Yes

Document Name

Comment

Likes 0

Dislikes 0

Response

Allen Schriver - NextEra Energy - 5

Answer Yes

Document Name

Comment

Likes 0

Dislikes 0

Response**Jodirah Green - ACES Power Marketing - 1,3,4,5,6 - MRO,WECC,Texas RE,SERC,RF, Group Name ACES Standard Collaborations****Answer**

Yes

Document Name**Comment**

Likes 0

Dislikes 0

Response**Thomas Savin - New York Power Authority - 6****Answer**

Yes

Document Name**Comment**

Likes 0

Dislikes 0

Response**Rachel Coyne - Texas Reliability Entity, Inc. - 10****Answer**

Yes

Document Name**Comment**

Likes 0

Dislikes 0

Response

Nick Batty - Keys Energy Services - NA - Not Applicable - FRCC

Answer Yes

Document Name

Comment

Likes 0

Dislikes 0

Response

Anton Vu - Los Angeles Department of Water and Power - 6

Answer Yes

Document Name

Comment

Likes 0

Dislikes 0

Response

Greg Davis - Georgia Transmission Corporation - 1

Answer Yes

Document Name

Comment

Likes 0

Dislikes 0

Response

Brandon McCormick - Brandon McCormick On Behalf of: Carol Chinn, Florida Municipal Power Agency, 6, 4, 3, 5; Chris Gowder, Florida Municipal Power Agency, 6, 4, 3, 5; Darko Kovac, Gainesville Regional Utilities, 1, 5, 3; David Owens, Gainesville Regional Utilities, 1, 5, 3; Don Cuevas, Beaches Energy Services, 1, 3; Joe McKinney, Florida Municipal Power Agency, 6, 4, 3, 5; Neville Bowen, Ocala Utility Services, 3; Nick Batty, Keys Energy Services, 4; Richard Montgomery, Florida Municipal Power Agency, 6, 4, 3, 5; Steven Lancaster, Beaches Energy Services, 1, 3; Tom Reedy, Florida Municipal Power Pool, 6; - Brandon McCormick, Group Name FMPPA

Answer Yes

Document Name	
Comment	
Likes 0	
Dislikes 0	
Response	
Jamie Monette - Allete - Minnesota Power, Inc. - 1	
Answer	Yes
Document Name	
Comment	
Likes 0	
Dislikes 0	
Response	
Sandra Shaffer - Berkshire Hathaway - PacifiCorp - 6	
Answer	Yes
Document Name	
Comment	
Likes 0	
Dislikes 0	
Response	
Bette White - AES - Indianapolis Power and Light Co. - 3	
Answer	Yes
Document Name	
Comment	
Likes 0	
Dislikes 0	

Response

Leo Bernier - AES - AES Corporation - 5

Answer Yes

Document Name

Comment

Likes 0

Dislikes 0

Response

Todd Bennett - Associated Electric Cooperative, Inc. - 3, Group Name AECI

Answer

Document Name

Comment

AECI supports the comments submitted by ACES

Likes 0

Dislikes 0

Response

Richard Vine - California ISO - 2

Answer

Document Name

Comment

The California ISO supports the comments as submitted by the ISO/RTO Council Standards Review Committee (SRC)

Likes 0

Dislikes 0

Response

Kagen DelRio - Kagen DelRio On Behalf of: doug white, North Carolina Electric Membership Corporation, 4, 3, 5; John Lemire, North Carolina Electric Membership Corporation, 4, 3, 5; Robert Beadle, North Carolina Electric Membership Corporation, 4, 3, 5; - Kagen DelRio

Answer	
Document Name	
Comment	
NCEMC supports the comments submitted by ACES	
Likes 0	
Dislikes 0	
Response	

8. The SDT added Quebec Interconnection-wide Variance to Requirement R2 with more stringent voltage boundaries for the No Trip Zone. Do you agree with this proposed Quebec Variance? If not, please provide your rationale

Pamela Hunter - Southern Company - Southern Company Services, Inc. - 1,3,5,6 - SERC, Group Name Southern Company

Answer No

Document Name

Comment

We believe that the variance language can be sufficiently and effectively handled in the Quebec Interconnect specific figure similar to the frequency "no trip zone" Quebec specific chart and that a separate variance section is not required.

Likes 0

Dislikes 0

Response

Alyssa Hubbard - SCANA - South Carolina Electric and Gas Co. - 5

Answer Yes

Document Name

Comment

I am in agreement with comments submitted by Sean Bodkin-Dominion.

Likes 0

Dislikes 0

Response

Chris Scanlon - Exelon - 1

Answer Yes

Document Name

Comment

Exelon does not own any facilities in the Quebec Interconnection so has no opinion on this revision.

Exelon, Segments 1, 3, 5, 6

Likes 0

Dislikes 0

Response

Aaron Cavanaugh - Bonneville Power Administration - 1,3,5,6 - WECC

Answer Yes

Document Name

Comment

None

Likes 0

Dislikes 0

Response

Constantin Chitescu - Ontario Power Generation Inc. - 5

Answer Yes

Document Name

Comment

Likes 0

Dislikes 0

Response

Charles Yeung - Southwest Power Pool, Inc. (RTO) - 2, Group Name SRC

Answer Yes

Document Name

Comment

Likes 0

Dislikes 0

Response

Armin Klusman - CenterPoint Energy Houston Electric, LLC - 1 - Texas RE

Answer Yes

Document Name	
Comment	
Likes 0	
Dislikes 0	
Response	
Mark Gray - Edison Electric Institute - NA - Not Applicable - NA - Not Applicable	
Answer	Yes
Document Name	
Comment	
Likes 0	
Dislikes 0	
Response	
Ruida Shu - Northeast Power Coordinating Council - 1,2,3,4,5,6,7,8,9,10 - NPCC, Group Name RSC no Dominion and Con Ed	
Answer	Yes
Document Name	
Comment	
Likes 0	
Dislikes 0	
Response	
Douglas Webb - Douglas Webb On Behalf of: Allen Klassen, Westar Energy, 6, 3, 1, 5; Bryan Taggart, Westar Energy, 6, 3, 1, 5; Derek Brown, Westar Energy, 6, 3, 1, 5; Grant Wilkerson, Westar Energy, 6, 3, 1, 5; James McBee, Great Plains Energy - Kansas City Power and Light Co., 1, 3, 6, 5; Jennifer Flandermeyer, Great Plains Energy - Kansas City Power and Light Co., 1, 3, 6, 5; John Carlson, Great Plains Energy - Kansas City Power and Light Co., 1, 3, 6, 5; Marcus Moor, Great Plains Energy - Kansas City Power and Light Co., 1, 3, 6, 5; - Douglas Webb, Group Name Westar-KCPL	
Answer	Yes
Document Name	
Comment	

Likes 0

Dislikes 0

Response

Greg Davis - Georgia Transmission Corporation - 1

Answer Yes

Document Name

Comment

Likes 0

Dislikes 0

Response

Davis Jelusich - Public Utility District No. 1 of Chelan County - 6

Answer Yes

Document Name

Comment

Likes 0

Dislikes 0

Response

Nick Batty - Keys Energy Services - NA - Not Applicable - FRCC

Answer Yes

Document Name

Comment

Likes 0

Dislikes 0

Response

Thomas Savin - New York Power Authority - 6

Answer	Yes
Document Name	
Comment	
Likes 0	
Dislikes 0	
Response	
Jodirah Green - ACES Power Marketing - 1,3,4,5,6 - MRO,WECC,Texas RE,SERC,RF, Group Name ACES Standard Collaborations	
Answer	Yes
Document Name	
Comment	
Likes 0	
Dislikes 0	
Response	
Scott Langston - Tallahassee Electric (City of Tallahassee, FL) - 1	
Answer	Yes
Document Name	
Comment	
Likes 0	
Dislikes 0	
Response	
Allen Schriver - NextEra Energy - 5	
Answer	Yes
Document Name	
Comment	
Likes 0	

Dislikes 0

Response

Scott Parker - SCANA - South Carolina Electric and Gas Co. - 3

Answer

Yes

Document Name

Comment

Likes 0

Dislikes 0

Response

Shirley Mathew - Austin Energy - 5

Answer

Yes

Document Name

Comment

Likes 1

Austin Energy, 3, Preston W. Dwayne

Dislikes 0

Response

Andrew Gallo - Austin Energy - 1,3,4,5,6

Answer

Yes

Document Name

Comment

Likes 0

Dislikes 0

Response

Richard Jackson - U.S. Bureau of Reclamation - 1

Answer

Yes

Document Name	
Comment	
Likes 0	
Dislikes 0	
Response	
Tom Hanzlik - SCANA - South Carolina Electric and Gas Co. - 1	
Answer	Yes
Document Name	
Comment	
Likes 0	
Dislikes 0	
Response	
RoLynda Shumpert - SCANA - South Carolina Electric and Gas Co. - 1,3,5,6 - SERC	
Answer	Yes
Document Name	
Comment	
Likes 0	
Dislikes 0	
Response	
Jesus Sammy Alcaraz - Imperial Irrigation District - 1	
Answer	Yes
Document Name	
Comment	
Likes 0	
Dislikes 0	

Response

Matthew Nutsch - Seattle City Light - 1,3,4,5,6 - WECC

Answer Yes

Document Name

Comment

Likes 0

Dislikes 0

Response

Michelle Amarantos - APS - Arizona Public Service Co. - 1

Answer Yes

Document Name

Comment

Likes 0

Dislikes 0

Response

David Jendras - Ameren - Ameren Services - 3

Answer Yes

Document Name

Comment

Likes 0

Dislikes 0

Response

Lana Smith - San Miguel Electric Cooperative, Inc. - 5

Answer Yes

Document Name

Comment

Likes 0

Dislikes 0

Response**Neil Swearingen - Salt River Project - 1,3,5,6 - WECC****Answer**

Yes

Document Name**Comment**

Likes 0

Dislikes 0

Response**Amy Casuscelli - Amy Casuscelli On Behalf of: Gerry Huitt, Xcel Energy, Inc., 3, 1, 5; - Amy Casuscelli****Answer**

Yes

Document Name**Comment**

Likes 0

Dislikes 0

Response**Eric Smith - NaturEner USA, LLC - 5****Answer**

Yes

Document Name**Comment**

Likes 0

Dislikes 0

Response

Sean Bodkin - Dominion - Dominion Resources, Inc. - 6, Group Name Dominion

Answer Yes

Document Name

Comment

Likes 1 SCANA - South Carolina Electric and Gas Co., 1,3,5,6, Shumpert RoLynda

Dislikes 0

Response

Glen Farmer - Avista - Avista Corporation - 5

Answer Yes

Document Name

Comment

Likes 0

Dislikes 0

Response

Leonard Kula - Independent Electricity System Operator - 2

Answer Yes

Document Name

Comment

Likes 0

Dislikes 0

Response

Maryanne Darling-Reich - Black Hills Corporation - 1,3,5,6 - MRO,WECC

Answer Yes

Document Name

Comment

Likes 0

Dislikes 0

Response

Karie Barczak - DTE Energy - Detroit Edison Company - 3, Group Name DTE Energy - DTE Electric

Answer

Yes

Document Name

Comment

Likes 0

Dislikes 0

Response

Kagen DelRio - Kagen DelRio On Behalf of: doug white, North Carolina Electric Membership Corporation, 4, 3, 5; John Lemire, North Carolina Electric Membership Corporation, 4, 3, 5; Robert Beadle, North Carolina Electric Membership Corporation, 4, 3, 5; - Kagen DelRio

Answer

Document Name

Comment

NCEMC supports the comments submitted by ACES

Likes 0

Dislikes 0

Response

Richard Vine - California ISO - 2

Answer

Document Name

Comment

The California ISO supports the comments as submitted by the ISO/RTO Council Standards Review Committee (SRC)

Likes 0

Dislikes 0

Response

Leo Bernier - AES - AES Corporation - 5

Answer

Document Name

Comment

AES is not part of the Quebec Variance so has no comment.

Likes 0

Dislikes 0

Response

Bette White - AES - Indianapolis Power and Light Co. - 3

Answer

Document Name

Comment

IPL is not part of the Quebec region

Likes 0

Dislikes 0

Response

Todd Bennett - Associated Electric Cooperative, Inc. - 3, Group Name AECI

Answer

Document Name

Comment

AECI supports the comments submitted by ACES

Likes 0

Dislikes 0

Response

Jamie Monette - Allete - Minnesota Power, Inc. - 1

Answer

Document Name

Comment

NA

Likes 0

Dislikes 0

Response

Anton Vu - Los Angeles Department of Water and Power - 6

Answer

Document Name

Comment

No comment, as this Variance does not apply to LDWP.

Likes 0

Dislikes 0

Response

Rachel Coyne - Texas Reliability Entity, Inc. - 10

Answer

Document Name

Comment

Texas RE does not have comments on the question.

Likes 0

Dislikes 0

Response

Kim Thomas - Duke Energy - 1,3,5,6 - FRCC,SERC,RF, Group Name Duke Energy

Answer

Document Name	
Comment	
Abstain.	
Likes 0	
Dislikes 0	
Response	
Ozan Ferrin - Tacoma Public Utilities (Tacoma, WA) - 5	
Answer	
Document Name	
Comment	
N/A	
Likes 0	
Dislikes 0	
Response	
Dennis Chastain - Tennessee Valley Authority - 1,3,5,6 - SERC	
Answer	
Document Name	
Comment	
We have no opinion on the Quebec Variance.	
Likes 0	
Dislikes 0	
Response	
Jennifer Hohenshilt - Talen Energy Marketing, LLC - 6	
Answer	
Document Name	
Comment	

Abstain.

Likes 0

Dislikes 0

Response

Matthew McMillan - Talen Generation, LLC - 5

Answer

Document Name

Comment

Abstain – we are not in the Quebec Region.

Likes 0

Dislikes 0

Response

9. Do you agree with the proposed Implementation Plan? If not, please provide your rationale

Thomas Foltz - AEP - 5

Answer No

Document Name

Comment

AEP disagrees with the proposed revisions which expand the scope of this standard. We believe that 18 months is insufficient, especially in regards to impacts associated with a) changing, albeit unintentionally, the historically recognized "Point of Interconnection" as the reference point of compliance and b) the inclusion of applicable functions on the high-side of generator-connected auxiliary transformers. AEP suggests that the proposed implementation plan be increased to 36 months as the proposed changes would redefine the entire scope of the work performed to date.

Likes 0

Dislikes 0

Response

Jeanne Kurzynowski - CMS Energy - Consumers Energy Company - 1,3,4,5 - RF

Answer No

Document Name

Comment

With the current lack of understanding of the behavior of existing installed equipment with regard to "momentary cessation", and the resulting required interaction with manufacturers and then implementing any necessary changes, 18 months does not seem to be a sufficient amount of time.

Likes 0

Dislikes 0

Response

Dennis Chastain - Tennessee Valley Authority - 1,3,5,6 - SERC

Answer No

Document Name

Comment

What is the basis for the Compliance Dates in the Implementation Plan, i.e. 18-months for GOs and 60-months (18-months plus 42-months) for TOs? If changes are required, many facilities can't make them that quickly as they have to 1) obtain funding for and perform an analysis to see if they have compliance gaps and, if so, 2) obtain funding for the change(s), 3) complete a design for the change(s), and 4) implement the changes which will likely require an outage that can be as much as two years in the future. The original dates for version 1 (and 2) were

phased in over a longer period. Please provide a longer time for compliance along the lines of the earlier versions or, at least, give the GOs the same 60-month time frame as the TOs.

Likes 1

Tarantino Joe On Behalf of: Arthur Starkovich, Sacramento Municipal Utility District, 4, 1, 5, 6,

Dislikes 0

Response

Lana Smith - San Miguel Electric Cooperative, Inc. - 5

Answer

No

Document Name

Comment

We believe 18 months may not be sufficient for GOs to verify the setting based upon to the proposed changes in the SAR. As an example, replacing "instantaneous" language with "0.10 second" requires entities to verify the existing setting to meet this requirement. Cost Impacts are an important aspect to be studied. Considerations of estimated time-extensions cost impacts and company budget cycles is requested to be measured in the time-extension decisions.

Likes 0

Dislikes 0

Response

Dana Klem - MRO - 1,2,3,4,5,6 - MRO, Group Name MRO NSRF

Answer

No

Document Name

Comment

There may be substantial retesting and replacements to comply with this proposed Standard. The NSRF recommends a 24 month implementation plan as this will give Entities planning time for maintenance outages and for budget forecasting purposes.

Likes 0

Dislikes 0

Response

Alex Chua - Pacific Gas and Electric Company - 1,3,5

Answer

No

Document Name

Comment

A longer implementation plan should be provided when relay replacements or control upgrades are required.

Likes 0

Dislikes 0

Response

Scott Berry - Scott Berry On Behalf of: Jack Alvey, Indiana Municipal Power Agency, 1, 4; - Scott Berry

Answer

No

Document Name

Comment

The way the current draft is written and the possible inclusion of new equipment and systems, entities should be given more time. Generator Owners should be given 36 months from the time the standard is approved by FERC to become compliant with the current drafted requirements. This would allow for communication with the appropriate parties to see how systems would react to the current proposed set points and maybe allow any applicable modeling that may be required. If the standard was truly just adding solar plant inverters, the current proposed implementation plan would be sufficient.

Likes 0

Dislikes 0

Response

Don Schmit - Nebraska Public Power District - 1,3,5

Answer

No

Document Name

Comment

NPPD supports the comments submitted by the MRO NSRF.

Likes 0

Dislikes 0

Response

Kim Thomas - Duke Energy - 1,3,5,6 - FRCC,SERC,RF, Group Name Duke Energy

Answer

No

Document Name

Comment

Duke Energy recommends a 24 month implementation timeframe that would allow sites to better plan their outages, costs and resources for this change.

Likes 0

Dislikes 0

Response

Jeremy Voll - Basin Electric Power Cooperative - 1,3,5,6

Answer

No

Document Name

Comment

Support the MRO NSRF Comments

Likes 0

Dislikes 0

Response

Andrew Gallo - Austin Energy - 1,3,4,5,6

Answer

No

Document Name

Comment

Propose to change the implementation plan time to 42 months.

The current instantaneous trip allowance for Synchronous generator has been in place for several years with no identified impact on the bulk power system. Austin Energy suggests the SDT consider a longer implementation period than 18 months for the necessary protection scheme changes, implementation and testing of the protection systems associated with the new requirement.

Likes 0

Dislikes 0

Response

Shirley Mathew - Austin Energy - 5

Answer

No

Document Name

Comment

Propose to change the implementation time to 42 months.

The current instantaneous trip allowance for Synchronous generator has been in place for several years with no identified adverse impact on the bulk power system. It is suggested that the SDT consider longer implementation period than 18 months for the necessary protection scheme changes, implementation and testing of the protection systems associated with the new requirement.

Likes 1

Austin Energy, 3, Preston W. Dwayne

Dislikes 0

Response**Allen Schriver - NextEra Energy - 5**

Answer

No

Document Name

Comment

Comments: As stated in the response to question #5, transmission asynchronous inerties exhibit the same momentary cessation issues due to voltage and frequency excursions as solar inverters, (see the Pacific DC Intertie information in the WECC May 11, 2018 event report). This is no less an issue for protecting reliability, but transmission owners will be provided approximately 60 months to fully comply. The costs associated with implementation can be incorporated into their tariff rates; therefore, transmission owner will not be effected economically.

Likes 0

Dislikes 0

Response**Chris Scanlon - Exelon - 1**

Answer

No

Document Name

Comment

Nuclear generating units typically run continuously and therefore implementation would have to be done during a scheduled refueling outage (typically 2 years for a boiling water reactor and 18 months for a pressurized water reactor). The scheduling to implement design changes during refueling outages is typically scoped at least 24 months in advance. The current draft of the PRC-024-3 implementation plan states that the Standard shall become effective on the first day of the first calendar quarter that is eighteen (18) months after the effective date of the applicable governmental authority's order approving the Standard. The original dates for Version 1 (and 2) were phased in over five calendar years. Exelon requests that the effective date for Generator Owners be extended to the same 60-month time frame afforded the Transmission Owners to allow reasonable time for a nuclear generating unit to evaluate and implement any necessary design changes during a planned refueling outage.

Exelon, Segments 1, 3, 5, 6

Likes 0

Dislikes 0

Response

Scott Langston - Tallahassee Electric (City of Tallahassee, FL) - 1

Answer

No

Document Name

Comment

Eighteen months is relatively short duration to make changes to embedded protection systems for GO when considering an entire fleet. Often these changes may need to follow unit outage schedules. The implementation plan should provide additional time for this requirement as a result of fleet size and the need for scheduled outages. GO/TO timelines should be similar.

Likes 0

Dislikes 0

Response

Pamela Hunter - Southern Company - Southern Company Services, Inc. - 1,3,5,6 - SERC, Group Name Southern Company

Answer

No

Document Name

Comment

Do not agree with the implementation plan since we do not agree completely with the modified purpose, applicability, facilities, and requirements of this draft version.

Likes 0

Dislikes 0

Response

Jodirah Green - ACES Power Marketing - 1,3,4,5,6 - MRO,WECC,Texas RE,SERC,RF, Group Name ACES Standard Collaborations

Answer

No

Document Name

Comment

We believe 18 months is not sufficient for GOs to verify the setting based upon to the proposed changes in the SAR. As an example, replacing "instantaneous" language with "0.10 second" requires entities to verify the existing setting to meet this requirement. Cost Impacts are an important aspect to be studied. Considerations of estimated time-extensions cost impacts and company budget cycles is requested to be measured in the time-extension decisions.

Likes 0

Dislikes 0

Response

Davis Jelusich - Public Utility District No. 1 of Chelan County - 6

Answer

No

Document Name

Comment

Replacing the term "protective relays" with "protection" triggers a review of generating resource protection devices, specifically exciter protection functions. While it does not appear to be the intention of the SAR and the SDT's current draft, other types of voltage and frequency protection devices associated with each generating unit or resource could also potentially fall within scope of PRC-024-3. Consideration should be given to the time required to identify these protections and, if needed, implement appropriate protection setting modifications within the PRC-024-3 Implementation Plan, especially if exclusions of these other protection systems are not provided.

Likes 0

Dislikes 0

Response

Anton Vu - Los Angeles Department of Water and Power - 6

Answer

No

Document Name

Comment

It is suggested that the Implementation Plan allow the Generator Owner an additional six months after the effective date to implement the revised Standard.

Likes 0

Dislikes 0

Response

Greg Davis - Georgia Transmission Corporation - 1

Answer	No
Document Name	
Comment	
<p>We believe 18 months is not sufficient for GOs to verify the setting based upon to the proposed changes in the SAR. As an example, replacing "instantaneous" language with "0.10 second" requires entities to verify the existing setting to meet this requirement. Cost Impacts are an important aspect to be studied. Considerations of estimated time-extensions cost impacts and company budget cycles is requested to be measured in the time-extension decisions.</p>	
Likes	0
Dislikes	0
Response	
<p>Douglas Webb - Douglas Webb On Behalf of: Allen Klassen, Westar Energy, 6, 3, 1, 5; Bryan Taggart, Westar Energy, 6, 3, 1, 5; Derek Brown, Westar Energy, 6, 3, 1, 5; Grant Wilkerson, Westar Energy, 6, 3, 1, 5; James McBee, Great Plains Energy - Kansas City Power and Light Co., 1, 3, 6, 5; Jennifer Flandermeyer, Great Plains Energy - Kansas City Power and Light Co., 1, 3, 6, 5; John Carlson, Great Plains Energy - Kansas City Power and Light Co., 1, 3, 6, 5; Marcus Moor, Great Plains Energy - Kansas City Power and Light Co., 1, 3, 6, 5; - Douglas Webb, Group Name Westar-KCPL</p>	
Answer	No
Document Name	
Comment	
<p>Comments: Kansas City Power & Light Company and Westar endorses comments submitted by EEI member companies. In order to better accommodate nuclear power plant refueling and maintenance outages, EEI recommended extension to 18 to 24 months. In some cases depending on the where an entity is in the cycle, this may extend to 36 months. The Implementation plan will need to account for this nuance.</p>	
Likes	0
Dislikes	0
Response	
<p>Sandra Shaffer - Berkshire Hathaway - PacifiCorp - 6</p>	
Answer	No
Document Name	
Comment	
<p>Comments: There may be substantial retesting and replacements to comply with this proposed Standard. The NSRF recommends a 24 month implementation plan as this will give Entities planning time for maintenance outages and for budget forecasting purposes.</p>	

Likes	0
Dislikes	0
Response	
Mark Gray - Edison Electric Institute - NA - Not Applicable - NA - Not Applicable	
Answer	No
Document Name	
Comment	
EEI member companies suggest that the implementation plan be extended from 18 months to 24 months in order to better accommodate nuclear power plant refueling and maintenance outages which generally occur on 18 to 24 month intervals.	
Likes	0
Dislikes	0
Response	
Armin Klusman - CenterPoint Energy Houston Electric, LLC - 1 - Texas RE	
Answer	No
Document Name	
Comment	
CenterPoint Energy Houston Electric, LLC supports the comments submitted by the Edison Electric Institute.	
Likes	0
Dislikes	0
Response	
Karie Barczak - DTE Energy - Detroit Edison Company - 3, Group Name DTE Energy - DTE Electric	
Answer	Yes
Document Name	
Comment	
For a nuclear generating unit implementation would have to be during a scheduled refueling outage (typically 2 years for a boiling water reactor and 18 months for a pressurized water reactor). The scheduling for such outages is typically scoped at least 6 months in advance. The current draft of the PRC-024-3 implementation plan states that the Standard shall become effective on the first day of the first calendar quarter that is eighteen (18) months after the effective date of the applicable governmental authority's order approving the Standard. We request that this effective date be extended to 24	

months following the effective date to allow reasonable time for a nuclear generating unit to evaluate and implement any necessary design changes during a planned refueling outage.

Likes 0

Dislikes 0

Response

Aaron Cavanaugh - Bonneville Power Administration - 1,3,5,6 - WECC

Answer

Yes

Document Name

Comment

None

Likes 0

Dislikes 0

Response

Matthew Nutsch - Seattle City Light - 1,3,4,5,6 - WECC

Answer

Yes

Document Name

Comment

Likes 0

Dislikes 0

Response

Bette White - AES - Indianapolis Power and Light Co. - 3

Answer

Yes

Document Name

Comment

The changes in the implementation plan do not affect IPL.

Likes 0

Dislikes 0

Response

Bradley Collard - SunPower - 5

Answer

Yes

Document Name

Comment

Yes, but with some reservation. Depending on changes that must be done on inverters and the availability of inverter manufacturer resources to make those changes, coupled with the amount of work that may apply to protective relays with the new 0.10 trip setting, the Requirement may present challenges. The time allowed to conduct an analysis, budget the work, and schedule the work with the appropriate resources could push the bulk of the work in the last 12 to 6 months of the timeline. That may present scheduling challenges with limited industry resources. Consider allowing 24 months if both protective functions and inverter functions need to be changed.

Likes 0

Dislikes 0

Response

Maryanne Darling-Reich - Black Hills Corporation - 1,3,5,6 - MRO,WECC

Answer

Yes

Document Name

Comment

Likes 0

Dislikes 0

Response

Matthew McMillan - Talen Generation, LLC - 5

Answer

Yes

Document Name

Comment

Likes 0

Dislikes 0

Response

Jennifer Hohenshilt - Talen Energy Marketing, LLC - 6

Answer Yes

Document Name

Comment

Likes 0

Dislikes 0

Response

Leonard Kula - Independent Electricity System Operator - 2

Answer Yes

Document Name

Comment

Likes 0

Dislikes 0

Response

Sean Bodkin - Dominion - Dominion Resources, Inc. - 6, Group Name Dominion

Answer Yes

Document Name

Comment

Likes 1

SCANA - South Carolina Electric and Gas Co., 1,3,5,6, Shumpert RoLynda

Dislikes 0

Response

Chris Wagner - Santee Cooper - 1, Group Name Santee Cooper

Answer Yes

Document Name

Comment

Likes 0

Dislikes 0

Response

Eric Smith - NaturEner USA, LLC - 5

Answer

Yes

Document Name

Comment

Likes 0

Dislikes 0

Response

Amy Casuscelli - Amy Casuscelli On Behalf of: Gerry Huitt, Xcel Energy, Inc., 3, 1, 5; - Amy Casuscelli

Answer

Yes

Document Name

Comment

Likes 0

Dislikes 0

Response

Neil Swearingen - Salt River Project - 1,3,5,6 - WECC

Answer

Yes

Document Name

Comment

Likes 0

Dislikes 0

Response

David Jendras - Ameren - Ameren Services - 3

Answer Yes

Document Name

Comment

Likes 0

Dislikes 0

Response

Ozan Ferrin - Tacoma Public Utilities (Tacoma, WA) - 5

Answer Yes

Document Name

Comment

Likes 0

Dislikes 0

Response

Michelle Amarantos - APS - Arizona Public Service Co. - 1

Answer Yes

Document Name

Comment

Likes 0

Dislikes 0

Response

Jesus Sammy Alcaraz - Imperial Irrigation District - 1

Answer Yes

Document Name

Comment

Likes 0

Dislikes 0

Response

Richard Jackson - U.S. Bureau of Reclamation - 1

Answer

Yes

Document Name

Comment

Likes 0

Dislikes 0

Response

Thomas Savin - New York Power Authority - 6

Answer

Yes

Document Name

Comment

Likes 0

Dislikes 0

Response

Nick Batty - Keys Energy Services - NA - Not Applicable - FRCC

Answer

Yes

Document Name

Comment

Likes 0

Dislikes 0

Response

Brandon McCormick - Brandon McCormick On Behalf of: Carol Chinn, Florida Municipal Power Agency, 6, 4, 3, 5; Chris Gowder, Florida Municipal Power Agency, 6, 4, 3, 5; Darko Kovac, Gainesville Regional Utilities, 1, 5, 3; David Owens, Gainesville Regional Utilities, 1, 5, 3; Don Cuevas, Beaches Energy Services, 1, 3; Joe McKinney, Florida Municipal Power Agency, 6, 4, 3, 5; Neville Bowen, Ocala Utility Services, 3; Nick Batty, Keys Energy Services, 4; Richard Montgomery, Florida Municipal Power Agency, 6, 4, 3, 5; Steven Lancaster, Beaches Energy Services, 1, 3; Tom Reedy, Florida Municipal Power Pool, 6; - Brandon McCormick, Group Name FMMPA

Answer

Yes

Document Name

Comment

Likes 0

Dislikes 0

Response

Jamie Monette - Allele - Minnesota Power, Inc. - 1

Answer

Yes

Document Name

Comment

Likes 0

Dislikes 0

Response

Ruida Shu - Northeast Power Coordinating Council - 1,2,3,4,5,6,7,8,9,10 - NPCC, Group Name RSC no Dominion and Con Ed

Answer

Yes

Document Name

Comment

Likes 0

Dislikes 0

Response

Charles Yeung - Southwest Power Pool, Inc. (RTO) - 2, Group Name SRC

Answer

Yes

Document Name

Comment	
Likes 0	
Dislikes 0	
Response	
Constantin Chitescu - Ontario Power Generation Inc. - 5	
Answer	Yes
Document Name	
Comment	
Likes 0	
Dislikes 0	
Response	
Joe Tarantino - Joe Tarantino On Behalf of: Arthur Starkovich, Sacramento Municipal Utility District, 4, 1, 5, 6, 3; Beth Tincher, Sacramento Municipal Utility District, 4, 1, 5, 6, 3; Jamie Cutlip, Sacramento Municipal Utility District, 4, 1, 5, 6, 3; Kevin Smith, Balancing Authority of Northern California, 1; Nicole Looney, Sacramento Municipal Utility District, 4, 1, 5, 6, 3; Susan Oto, Sacramento Municipal Utility District, 4, 1, 5, 6, 3; - Joe Tarantino	
Answer	
Document Name	
Comment	
<p><i>Regarding the implementation period associated with the proposed 0.1-second time delay, given the current instantaneous trip has been in place for several years with no identified impact on the bulk power system it is suggested that the SDT consider a longer implementation period for any necessary changes that are less than the proposed time delay of 0.1-seconds. Since the instantaneous settings has been in place and implemented for several years (20+ years) the proposed 18-month period may be problematic for some as it requires changes to the trip settings and any necessary testing associated with that proposed change.</i></p>	
Likes 2	Snohomish County PUD No. 1, 3, Chaney Holly; Public Utility District No. 1 of Snohomish County, 1, Duong Long
Dislikes 0	
Response	
Rachel Coyne - Texas Reliability Entity, Inc. - 10	
Answer	

Document Name

Comment

Texas RE requests justification for timeframe described in the Implementation Plan.

Likes 0

Dislikes 0

Response

Alyssa Hubbard - SCANA - South Carolina Electric and Gas Co. - 5

Answer

Document Name

Comment

I am in agreement with comments submitted by Sean Bodkin-Dominion.

Likes 0

Dislikes 0

Response

Todd Bennett - Associated Electric Cooperative, Inc. - 3, Group Name AECI

Answer

Document Name

Comment

AECI supports the comments submitted by ACES

Likes 0

Dislikes 0

Response

Richard Vine - California ISO - 2

Answer

Document Name

Comment

The California ISO supports the comments as submitted by the ISO/RTO Council Standards Review Committee (SRC)

Likes 0

Dislikes 0

Response

Kagen DelRio - Kagen DelRio On Behalf of: doug white, North Carolina Electric Membership Corporation, 4, 3, 5; John Lemire, North Carolina Electric Membership Corporation, 4, 3, 5; Robert Beadle, North Carolina Electric Membership Corporation, 4, 3, 5; - Kagen DelRio

Answer

Document Name

Comment

NCEMC supports the comments submitted by ACES

Likes 0

Dislikes 0

Response

10. Do you agree that the proposed modifications provide a cost-effective means of addressing issues in the SAR? If not, please provide an alternative, more cost-effective manner in which to achieve at least an equivalent level of reliability

Bradley Collard - SunPower - 5

Answer No

Document Name

Comment

SunPower does not understand how the longstanding frequency and voltage protective relay functions are now a concern and must be changed from "instantaneous trip" to "0.10" seconds. It seems it will cost many generators extra money for something that is not a concern. If the desire is to have inverters base their tripping in 6 cycles, then say so. Do not add extra work and costs to other generators that is not causing a reliability issue.

SunPower also would like to point out that changes in any protective relay function and/or voltage/frequency control functions on inverters will require additional costs to industry adjusting dynamic models to meet MOD-032 requirements.

NERC should consider older technology that is incapable of making the changes to be grandfathered and to allow for technical exceptions in order to avoid replacement costs of some equipment.

Likes 0

Dislikes 0

Response

Sandra Shaffer - Berkshire Hathaway - PacifiCorp - 6

Answer No

Document Name

Comment

The NSRF believes there may be substantial cost associated with this Standard but cannot state exactly what those cost are as this is the first interaction of the proposed Standard. See question 9.

Likes 0

Dislikes 0

Response

Douglas Webb - Douglas Webb On Behalf of: Allen Klassen, Westar Energy, 6, 3, 1, 5; Bryan Taggart, Westar Energy, 6, 3, 1, 5; Derek Brown, Westar Energy, 6, 3, 1, 5; Grant Wilkerson, Westar Energy, 6, 3, 1, 5; James McBee, Great Plains Energy - Kansas City Power and Light Co., 1, 3, 6, 5; Jennifer Flandermeyer, Great Plains Energy - Kansas City Power and Light Co., 1, 3, 6, 5; John Carlson, Great Plains Energy - Kansas City Power and Light Co., 1, 3, 6, 5; Marcus Moor, Great Plains Energy - Kansas City Power and Light Co., 1, 3, 6, 5; - Douglas Webb, Group Name Westar-KCPL

Answer No

Document Name	
Comment	
<p>Comments: Kansas City Power & Light Company and Westar finds the issues being addressed in this revision to add undue administrative burden to entities to prove compliance where the circumstances do not exist. The basis need for these changes is not widely applicable.</p>	
Likes 0	
Dislikes 0	
Response	
Greg Davis - Georgia Transmission Corporation - 1	
Answer	No
Document Name	
Comment	
<p>It is unclear how the cost assessment has been evaluated. We believe the SAR should provide additional clarification on how much cost will be potentially associated with the implementation of the proposed changes in the SAR. As an example, revising "instantaneous" language to "0.10 second" requires entities to verify their existing settings to ensure the accuracy of this timing. Has this been evaluated in the cost assessment? Cost Impacts are an important aspect to be studied. Considerations of estimated time-extensions cost impacts and company budget cycles is requested to be measured in the time-extension decisions.</p>	
Likes 0	
Dislikes 0	
Response	
Jodirah Green - ACES Power Marketing - 1,3,4,5,6 - MRO,WECC,Texas RE,SERC,RF, Group Name ACES Standard Collaborations	
Answer	No
Document Name	
Comment	
<p>It is unclear how the cost assessment has been evaluated. We believe the SAR should provide additional clarification on how much cost will be potentially associated with the implementation of the proposed changes in the SAR. As an example, revising "instantaneous" language to "0.10 second" requires entities to verify their existing settings to ensure the accuracy of this timing. Has this been evaluated in the cost assessment? Cost Impacts are an important aspect to be studied. Considerations of estimated time-extensions cost impacts and company budget cycles is requested to be measured in the time-extension decisions.</p>	

Likes 0

Dislikes 0

Response

Pamela Hunter - Southern Company - Southern Company Services, Inc. - 1,3,5,6 - SERC, Group Name Southern Company

Answer No

Document Name

Comment

The work being done on industry standards (IEEE P2800) to provide inverter manufacturers with the desired operation of inverter based generating plants will cause new equipment to be supplied with the ride through characteristics that are desirable. This, coupled with the fact that at least two major events of the past (referenced in the introductory paragraph of this proposed modification) did not cause significant impacts to the western interconnect. We believe that these two facts will unduly cause generator to have to retrofit or modify existing equipment at a significant cost in order to meet the requirements as currently written, where there is not a clear and present danger of the reduction of system reliability.

Likes 0

Dislikes 0

Response

Allen Schriver - NextEra Energy - 5

Answer No

Document Name

Comment

Comments: The SDT is assuming that the inverters at older solar facilities can be easily reprogrammed to meet the proposed requirements in an 18-month time period, if at all. There should be a provision for grandfathering, or at least allowing for a phased-in implementation for older solar inverters that have been in operation for a number of years.

Likes 0

Dislikes 0

Response

Shirley Mathew - Austin Energy - 5

Answer No

Document Name

Comment

It is not cost effective for Synchronous generator owners to revise, implement and test the relays with the intentional time delay proposed in the standard. Propose not to change the instantaneous trip criteria from the standard.

Likes 1 Austin Energy, 3, Preston W. Dwayne

Dislikes 0

Response

Andrew Gallo - Austin Energy - 1,3,4,5,6

Answer No

Document Name

Comment

It is not cost effective for Synchronous generator owners to revise, implement and test the relays with the intentional time delay proposed in the standard. Austin Energy proposes not changing the instantaneous trip criteria from the standard.

Likes 0

Dislikes 0

Response

Jeremy Voll - Basin Electric Power Cooperative - 1,3,5,6

Answer No

Document Name

Comment

Support the MRO NSRF Comments

Likes 0

Dislikes 0

Response

Don Schmit - Nebraska Public Power District - 1,3,5

Answer No

Document Name

Comment

NPPD supports the comments submitted by the MRO NSRF.

Likes 0

Dislikes 0

Response

Steven Rueckert - Western Electricity Coordinating Council - 10

Answer

No

Document Name

Comment

The potential need for synchronous generator owner to have to reset their protections system settings to address erroneous actions by inverter-based resource owner is not cost effective.

Likes 1

Tarantino Joe On Behalf of: Arthur Starkovich, Sacramento Municipal Utility District, 4, 1, 5, 6,

Dislikes 0

Response

Dana Klem - MRO - 1,2,3,4,5,6 - MRO, Group Name MRO NSRF

Answer

No

Document Name

Comment

The NSRF believes there may be substantial cost associated with this Standard but cannot state exactly what those cost are as this is the first interaction of the proposed Standard. See question 9.

Likes 0

Dislikes 0

Response

Lana Smith - San Miguel Electric Cooperative, Inc. - 5

Answer

No

Document Name

Comment

It is unclear how the cost assessment has been evaluated. We believe the SAR should provide additional clarification on how much cost will be potentially associated with the implementation of the proposed changes in the SAR. As an example, revising "instantaneous" language to "0.10 second" requires entities to verify their existing settings to ensure the accuracy of this timing. Has this been evaluated in the cost assessment? Cost Impacts are an important aspect to be studied. Considerations of estimated time-extensions cost impacts and company budget cycles is requested to be measured in the time-extension decisions.

Likes 0

Dislikes 0

Response

Dennis Chastain - Tennessee Valley Authority - 1,3,5,6 - SERC

Answer No

Document Name

Comment

Put in specific wording on auxiliary equipment not being within scope. Remove the requirements for transformer protection as their addition is not within the scope of the SAR.

Likes 0

Dislikes 0

Response

Sean Bodkin - Dominion - Dominion Resources, Inc. - 6, Group Name Dominion

Answer No

Document Name

Comment

Until the draft standard is on a final form Dominion Energy cannot comment on the proposed cost effectiveness.

Likes 1

SCANA - South Carolina Electric and Gas Co., 1,3,5,6, Shumpert RoLynda

Dislikes 0

Response

Jennifer Hohenshilt - Talen Energy Marketing, LLC - 6

Answer No

Document Name

Comment

Confusion caused by the concerns we are stating could render PRC-024-3 non-cost-effective.

Likes 0

Dislikes 0

Response**Matthew McMillan - Talen Generation, LLC - 5**

Answer

No

Document Name

Comment

No. Confusion caused by the concerns we are stating could render PRC-024-3 non-cost-effective.

Likes 0

Dislikes 0

Response**Chris Scanlon - Exelon - 1**

Answer

Yes

Document Name

Comment

Exelon, Segments 1, 3, 5, 6

Likes 0

Dislikes 0

Response**Michelle Amarantos - APS - Arizona Public Service Co. - 1**

Answer

Yes

Document Name

Comment

As discussed above, AZPS respectfully notes that the proposed modifications shift both cost and compliance responsibility for generator protection to TOs without explanation or justification. For this reason, AZPS is concerned that the modifications would not be cost-effective.

Likes 0

Dislikes 0

Response

Constantin Chitescu - Ontario Power Generation Inc. - 5

Answer

Yes

Document Name

Comment

Likes 0

Dislikes 0

Response

Leo Bernier - AES - AES Corporation - 5

Answer

Yes

Document Name

Comment

Likes 0

Dislikes 0

Response

Ruida Shu - Northeast Power Coordinating Council - 1,2,3,4,5,6,7,8,9,10 - NPCC, Group Name RSC no Dominion and Con Ed

Answer

Yes

Document Name

Comment

Likes 0

Dislikes 0

Response

Bette White - AES - Indianapolis Power and Light Co. - 3

Answer Yes

Document Name

Comment

Likes 0

Dislikes 0

Response

Jamie Monette - Allete - Minnesota Power, Inc. - 1

Answer Yes

Document Name

Comment

Likes 0

Dislikes 0

Response

Anton Vu - Los Angeles Department of Water and Power - 6

Answer Yes

Document Name

Comment

Likes 0

Dislikes 0

Response

Davis Jelusich - Public Utility District No. 1 of Chelan County - 6

Answer Yes

Document Name

Comment

Likes 0

Dislikes 0

Response**Thomas Savin - New York Power Authority - 6****Answer**

Yes

Document Name**Comment**

Likes 0

Dislikes 0

Response**Scott Langston - Tallahassee Electric (City of Tallahassee, FL) - 1****Answer**

Yes

Document Name**Comment**

Likes 0

Dislikes 0

Response**Richard Jackson - U.S. Bureau of Reclamation - 1****Answer**

Yes

Document Name**Comment**

Likes 0

Dislikes 0

Response

Jesus Sammy Alcaraz - Imperial Irrigation District - 1

Answer Yes

Document Name

Comment

Likes 0

Dislikes 0

Response

Kim Thomas - Duke Energy - 1,3,5,6 - FRCC,SERC,RF, Group Name Duke Energy

Answer Yes

Document Name

Comment

Likes 0

Dislikes 0

Response

Alex Chua - Pacific Gas and Electric Company - 1,3,5

Answer Yes

Document Name

Comment

Likes 0

Dislikes 0

Response

Ozan Ferrin - Tacoma Public Utilities (Tacoma, WA) - 5

Answer Yes

Document Name

Comment

Likes 0

Dislikes 0

Response

David Jendras - Ameren - Ameren Services - 3

Answer

Yes

Document Name

Comment

Likes 0

Dislikes 0

Response

Neil Swearingen - Salt River Project - 1,3,5,6 - WECC

Answer

Yes

Document Name

Comment

Likes 0

Dislikes 0

Response

Amy Casuscelli - Amy Casuscelli On Behalf of: Gerry Huitt, Xcel Energy, Inc., 3, 1, 5; - Amy Casuscelli

Answer

Yes

Document Name

Comment

Likes 0

Dislikes 0

Response

Eric Smith - NaturEner USA, LLC - 5**Answer** Yes**Document Name****Comment**

Likes 0

Dislikes 0

Response**Chris Wagner - Santee Cooper - 1, Group Name Santee Cooper****Answer** Yes**Document Name****Comment**

Likes 0

Dislikes 0

Response**Leonard Kula - Independent Electricity System Operator - 2****Answer** Yes**Document Name****Comment**

Likes 0

Dislikes 0

Response**Maryanne Darling-Reich - Black Hills Corporation - 1,3,5,6 - MRO,WECC****Answer** Yes**Document Name****Comment**

Likes 0

Dislikes 0

Response

Karie Barczak - DTE Energy - Detroit Edison Company - 3, Group Name DTE Energy - DTE Electric

Answer

Yes

Document Name

Comment

Likes 0

Dislikes 0

Response

Charles Yeung - Southwest Power Pool, Inc. (RTO) - 2, Group Name SRC

Answer

Document Name

Comment

The IRC SRC submits no response to this question.

Likes 0

Dislikes 0

Response

Kagen DelRio - Kagen DelRio On Behalf of: doug white, North Carolina Electric Membership Corporation, 4, 3, 5; John Lemire, North Carolina Electric Membership Corporation, 4, 3, 5; Robert Beadle, North Carolina Electric Membership Corporation, 4, 3, 5; - Kagen DelRio

Answer

Document Name

Comment

NCEMC supports the comments submitted by ACES

Likes 0

Dislikes 0

Response

Richard Vine - California ISO - 2

Answer

Document Name

Comment

The California ISO supports the comments as submitted by the ISO/RTO Council Standards Review Committee (SRC)

Likes 0

Dislikes 0

Response

Todd Bennett - Associated Electric Cooperative, Inc. - 3, Group Name AECI

Answer

Document Name

Comment

AECI supports the comments submitted by ACES

Likes 0

Dislikes 0

Response

Alyssa Hubbard - SCANA - South Carolina Electric and Gas Co. - 5

Answer

Document Name

Comment

I am in agreement with comments submitted by Sean Bodkin-Dominion.

Likes 0

Dislikes 0

Response

Rachel Coyne - Texas Reliability Entity, Inc. - 10

Answer	
Document Name	
Comment	
Texas RE does not have comments on the question.	
Likes 0	
Dislikes 0	
Response	
Tom Hanzlik - SCANA - South Carolina Electric and Gas Co. - 1	
Answer	
Document Name	
Comment	
I agree with the comments submitted by Sean Bodkin-Dominion	
Likes 0	
Dislikes 0	
Response	
RoLynda Shumpert - SCANA - South Carolina Electric and Gas Co. - 1,3,5,6 - SERC	
Answer	
Document Name	
Comment	
SCANA- South Carolina Electric and Gas (Dominion Energy South Carolina) is in agreement with comments form Sean Bodkin (Dominion Energy).	
Likes 0	
Dislikes 0	
Response	
Matthew Nutsch - Seattle City Light - 1,3,4,5,6 - WECC	
Answer	
Document Name	

Comment

With the exception of the removal of instantaneous tripping, I agree. If there is a concern with how the industry is measuring RMS, frequency, filtering, and other time varying signals that require filtering and a sample window, then we should possibly be mandating minimum specification requirements for protective relaying equipment, or standardizing how we are testing the relay elements to ensure they performing as expected.

Likes 0

Dislikes 0

Response

Jeanne Kurzynowski - CMS Energy - Consumers Energy Company - 1,3,4,5 - RF

Answer

Document Name

Comment

As we progress with new site development, we've been adding AVR options such as voltage droop, WindFREE (no load VAR generation) and WindRESERVE (production on units above nameplate, but will aggregate no more than GIA/power curtailment limit). How does this play into relay settings? Particularly from a dispersed generator perspective.

Likes 0

Dislikes 0

Response

11. If you have any additional comments on themes that have NOT already been addressed in the proceeding questions on this comment form, please provide them here

Karie Barczak - DTE Energy - Detroit Edison Company - 3, Group Name DTE Energy - DTE Electric

Answer

Document Name

Comment

none at this time.

Likes 0

Dislikes 0

Response

Matthew McMillan - Talen Generation, LLC - 5

Answer

Document Name

Comment

Supplemental issue #1 - The original draft of PRC-024-1 included, "shall not trip," language, which was replaced by, "set its protective relaying," after GOs pointed-out that we can control our relay settings, but no one knows what might happen to take units offline for the massive disturbances of PRC-024 Att. 1 and 2 (High/low drum level? High/low furnace pressure? CTG flame-out). PRC-024-3 has undone this pivotally important clarification by requiring that protection be set, "such that the generating resource does not trip." Units may trip regardless of how we set the protection for reasons that are out of scope for the standard and beyond our control. Many CTG protectives in particular are set by the OEM, and often can't be viewed by plant personnel much less adjusted. The, "set its protective relaying," language of PRC-024-2 should be retained.

Supplemental issue #2 - The new Voltage Boundary Detail #4 statement, "The boundaries assume a system frequency of 60 Hertz. When evaluating volts per hertz protection, magnitude of the high voltage boundary can be adjusted in proportion to deviations of frequency below 60 Hertz," is self-contradictory. How can we adjust the voltage boundary for frequency changes, per the second sentence, if the frequency is fixed at 60 Hertz per the first sentence?

Likes 0

Dislikes 0

Response

Jennifer Hohenshilt - Talen Energy Marketing, LLC - 6

Answer

Document Name

Comment

Supplemental Issue #1 - The original draft of PRC-024-1 included, "shall not trip," language, which was replaced by, "set its protective relaying," after GOs pointed out that we can control our relay settings, but no one knows what might happen to take units offline for the massive disturbances of PRC-024 Att.1 and 2 (High/low drum level? High/low furnace pressure? CTG flame-out). PRC-024-3 has undone this pivotally important clarification by requiring that protection be set, "such that the generating resource does not trip." Units may trip regardless of how we set the protection for reasons that are out of scope for the standard and beyond our control. Many CTG protectives in particular are set by the OEM, and often can't be viewed by plant personnel much less adjusted. The, "set its protective relaying," language of PRC-024-2 should be retained.

Supplemental Issue #2 - The new Voltage Boundary Detail #4 statement, "The boundaries assume a system frequency of 60 Hertz. When evaluating volts per hertz protection, magnitude of the high voltage boundary can be adjusted in proportion to deviations of frequency below 60 Hertz," is self-contradictory. How can we adjust the voltage boundary for frequency changes, per the second sentence, if the frequency is fixed at 60 Hertz per the first sentence?

Likes 0

Dislikes 0

Response

Jonathan Robbins - Seminole Electric Cooperative, Inc. - 1,3,4,5,6 - FRCC

Answer

Document Name

Comment

1.

- i. In section 4.2.1.3, can the drafting team more clearly describe a generator-connected unit auxiliary transformer? Is this merely a unit auxiliary transformer that has a high-side connection at the same voltage of a BES generator located at the same plant?
- ii. If a start-up transformer can support station load during times when the unit auxiliary becomes inoperable, e.g., emergencies, is this Standard applicable to the start-up transformer?
- iii. NERC has provided a definition of a Protection System that appears to not include control systems. Seminole requests that the team review the impact of modifying the definition of Protection System to potentially include control systems and provide potential changes to all impacted Standards as a unified initiative.
- iv. It's unclear in Attachments 1 and 2 whether the lines are in the No Trip Zone of the May Trip Zone. Can the Standard Drafting Team (SDT) please clarify?
- v. Seminole reads Attachment 1, Table 1, to not apply to any protection system settings less than 0.10 seconds. For example if we had a setting at .08 sec. that was in the no trip zone, this would not be applicable to this standard, Is this correct?
- vi. In Attachment 1, the low frequency (Hz) values are less than or equal signs until the final frequency. For Attachment 2, the low voltage (pu) points are less than signs with the final voltage being less than or equal. Why is this different? Should we be treating the boundary lines differently between attachments?
- vii. In the PRC-024-3 Summary of Key Changes document, in the Applicability Section, the second bullet states that voltage and frequency protection should be applied to both GSU and collector transformers. Can this be modified to state something more akin to that if frequency and/or voltage protection is enabled, this protection is applicable? The way it reads is that an entity may be required to enable all applicable frequency and voltage protection on this equipment.

- viii. The “Evaluating Protection Settings” section should be modified to coincide with the operating conditions of the generator. The power factor designation should be adjusted to align with whether the generator is underexcited or overexcited. Also, the language should be modified so that it clearly states that an entity may use steady state analysis for a dynamic situation.
- ix. PRC-024-2 footnote 1 specifically instructed entities to evaluate the V/Hz protection at nominal frequency (60 Hz). In the PRC-024-3 version, this detail was lost the translation of the footnotes into the facilities/requirements section. This will create ambiguity and may cause entities to believe they have to perform dynamic simulations to show compliance with V/Hz protection schemes.

Likes 0

Dislikes 0

Response

Thomas Foltz - AEP - 5

Answer

Document Name

Comment

AEP appreciates the work of the Standards Drafting Team and believes much of the proposed revisions to the Attachments would be very beneficial, however we have chosen to cast Negative ballots on the proposed revisions due to our concerns as expressed above. Chief among these concerns are replacing “at the point of interconnection,” with “at the high side of the generator step-up or collector transformer” as well as the inclusion of “High side of the generator-connected unit auxiliary transformer installed on BES generating resource(s)” within 4.2.1.3.

Comments Regarding Summary of Key Changes Document:

Regarding the bullet point “Specifies that voltage and frequency protection should be applied to both generator step-up (GSU) and collector transformers,” AEP recommends this bullet point be reworded to refer to **any** voltage or frequency protection that may happen to exist rather than prescriptively stating that voltage and frequency protection should be applied. As currently written, it appears too much like a recommendation to apply V and Hz protection. We suggest revising this key changes document to benefit future comment and balloting periods, as necessary.

Additional Comments Regarding Revised Standard:

Suggest revising Purpose from “To set generator protection such that generating resource(s) remain connected, continuing to support the BES during defined frequency and voltage excursions” to instead state “To ensure generator protection **is set** such that generating resource(s) remain connected **and continue to support** the BES during defined **durations of off-nominal frequency and voltage.**”

Suggested revisions to Voltage Boundary Clarifications Attachment:

Section Title: Change from to “Voltage Boundary Clarifications” to instead state “Voltage **and Frequency** Boundary Clarifications”

Item 2: Change from “The boundaries apply to voltage excursions regardless of the type of initiating event” to instead state “The boundaries apply to **off-nominal** voltage **and frequency durations** regardless of the type of initiating event.”

Item 3: Change from “The values in the tables represent the minimum time durations allowed for specified voltage excursion thresholds” to instead state “The values in the tables represent the minimum time durations **required** for specified voltage thresholds.” It may still be advantageous to retain the example here because it is too easy to misconstrue the boundaries as meaning no trip for excursions that remain within the boundaries rather than no trip for time durations at the defined levels.

Item 4: Change from “The boundaries assume a system frequency of 60 Hertz” to instead state “The boundaries assume a system **base** frequency of 60 Hertz.” Also, please add a “the “to the second sentence to state “When evaluating volts per hertz protection, **the** magnitude of the high voltage boundary can be adjusted in proportion to deviations of frequency below 60 Hertz.”

Item 5: Change “Voltages in the boundaries assume RMS fundamental frequency phase-to-ground or phase-to-phase voltage” to instead state “Voltage boundaries assume **per unit** RMS fundamental frequency phase-to-ground or phase-to-phase voltage.”

Likes 0

Dislikes 0

Response

Leonard Kula - Independent Electricity System Operator - 2

Answer

Document Name

Comment

We congratulate the SDT on making practical improvements, like replacing POI with the high side of the main output transformers, to this standard. We believe that the standard can improve reliability by including plant auxiliary equipment in the scope (please see Comment #6).

Likes 0

Dislikes 0

Response

Aaron Cavanaugh - Bonneville Power Administration - 1,3,5,6 - WECC

Answer

Document Name

Comment

BPA supports USBR's comments regarding R3 and R4:

"In the interest of developing completely clear, unambiguous, grammatically correct Requirements, R3 could be better stated as:

Each Generator Owner or Transmission Owner shall document each known regulatory or equipment limitation¹ that prevents an applicable generating resource(s) (unit) with generator frequency or voltage protection from meeting the protection setting criteria in Requirements R1 or R2. Documentation includes (but is not limited to) study results, experience from an actual event, or manufacturer's advice

The comment above can also be applied to R4. R4 is not very clear and may be providing an opportunity for entities to manipulate information to avoid complying. Recommend rewriting to clear up when and what processes allow for deviation from transmitting the setting information."

Likes 0

Dislikes 0

Response

Jeanne Kurzynowski - CMS Energy - Consumers Energy Company - 1,3,4,5 - RF

Answer

Document Name

Comment

The Title is "Generator Frequency and Voltage Protection Settings", yet the Facilities include GSU and collector transformers and Elements utilized in aggregation of dispersed power producing resources. Should the Title provide some indication that the Standard addresses more than just relaying at the generator? Note that not all voltage or frequency relaying at the Facilities is for the purpose of protecting the generator. For example, Volts per Hertz may be applied at the transformer high voltage side to protect the transformer. Operation of the V/Hz relay would remove the transformer and the connected generator(s) from service.

The Purpose is "To set generator protection, such that generating resource(s) remain connected...". The Facilities include GSU and collector transformers and Elements utilized in aggregation of dispersed power producing resources. Should the Purpose provide some indication that the Standard addresses more than just relaying at the generator? Also, the Facilities include more than just generating resource(s). Should the Purpose include dispersed power producing resources?

Facilities 4.2.1 includes "Frequency, voltage or volts per hertz protection including frequency or voltage protective functions within control systems". This specifically calls out volts per hertz protection, but then assumes the reader will understand that the exciter volts per hertz protective function (tripping) is a voltage protective function. Would it be better to specifically mention the volts per hertz protective function within control systems?

Facilities 4.2.1 states "...that provide tripping or momentary cessation signals to all or part of the generating resource". Currently only 4.2.1.1 is identified as being a generating resource. Should the statement be modified to include all or part of the dispersed power producing resources?

Facilities 4.2.1.5 makes reference to "the dispersed power producing resources". Is it clear that this is referring to the dispersed power producing resources of Facilities 4.2.1.4? Would it be better to provide a complete description of the applicable dispersed power producing resources in 4.2.1.5?

In Attachment 2, Evaluating Protection Settings, item 1. d. includes the assumption "The automatic voltage regulator is in automatic voltage control mode". If calculations are on the static case for steady state initial conditions, how does the automatic voltage regulator control mode come into play? Should item 1. d. be removed from the document?

Likes 0

Dislikes 0

Response

Sergey Kynev - Siemens - Siemens Energy, Inc. - NA - Not Applicable - NA - Not Applicable

Answer

Document Name

Comment

Likes 0

Dislikes 0

Response

Sean Bodkin - Dominion - Dominion Resources, Inc. - 6, Group Name Dominion

Answer

Document Name

Comment

Dominion Energy finds the Applicability section of proposed Reliability Standard PRC-024-2 to be confusing and overly complex. While we appreciate SDT efforts to be thorough, we do not believe that that references to the BES definition inclusions or exclusions are needed. We also do not see a need for the inclusion of underlying facilities associated with the applicable protection systems (e.g., GSUs, generating resources, auxiliary transformers, dispersed power producing resources, and collector transformers). For this reason, we offer the following as an alternative for SDT consideration, which we believe accomplishes the same goal more efficiently.

4. Applicability

4.1. Functional Entities

4.1.1 Generator Owners

(Dominion Energy disagrees with including TOs)

4.2 Exemptions

4.2.1 Plant auxiliary equipment protection systems

4.3 Facilities

4.3.1 Generator frequency protective relays (or functionally equivalent devices contained within a generating resource's control system)

4.3.1 Generator voltage protective relays (or functionally equivalent devices contained within a generating resource's control system)

Likes 1

SCANA - South Carolina Electric and Gas Co., 1,3,5,6, Shumpert RoLynda

Dislikes 0

Response

Dennis Chastain - Tennessee Valley Authority - 1,3,5,6 - SERC

Answer

Document Name

Comment

The title of the standard is “Generator Frequency and Voltage Protection Settings” and the Purpose is "To set generator protection..." Based on this, what is the basis for expanding the scope to include GSUs and unit auxiliary transformers as shown in 4.2.1.2 and 4.2.1.3? We don't see anything in the SAR that includes adding their protection.

Likes 0

Dislikes 0

Response

Neil Swearingen - Salt River Project - 1,3,5,6 - WECC

Answer

Document Name

Comment

SRP requests some additional clarification for R1. Originally PRC-024-2 listed exceptions were it is permissible to trip in the “no trip zone”(out of step or loss of field functions). Why were some exceptions removed and only the documented and communicated equipment limitations remain?

Likes 0

Dislikes 0

Response

Lana Smith - San Miguel Electric Cooperative, Inc. - 5

Answer

Document Name

Comment

SMEC appreciates the efforts of the SDT and the opportunity to comment.

Likes 0

Dislikes 0

Response

Michelle Amarantos - APS - Arizona Public Service Co. - 1

Answer

Document Name

Comment

Please modify Attachment 2, Evaluation Protection Settings, number 1. c. as follows, because there is no realistic scenario where the high side voltage will be 1.1 pu or higher and the generator voltage will be at 0.95 pf lagging. It is most realistic to use lagging pf for low voltage conditions and leading pf for high voltage conditions.

For low voltage protection use Power factor is 0.95 lagging (i.e. supplying reactive power to the system) as measured at the generator terminals. For high voltage settings use Power factor is 0.95 leading (i.e. taking reactive power from the system) as measured at the generator terminals.

AZPS also reiterates concern with the addition of the TO as an applicable entity shifting compliance and cost responsibility from the GO/GOPs to TO/TOPs, which are distinct, separate entities.

Likes 0

Dislikes 0

Response

Dana Klem - MRO - 1,2,3,4,5,6 - MRO, Group Name MRO NSRF

Answer

Document Name

Comment

The NSRF has the following recommendations:

The SDT could consider the following modification to Section 4.2 to add clarity (strikethrough is deleted text while italics is added text):

4.2. Facilities:

4.2.1 Frequency, voltage or volts per hertz protection *relays, software controls, firmware controls*, including frequency or voltage protective functions within control systems that provide tripping or momentary cessation signals to all or part of the generating resource, applied to the following:

4.2.1.1 Bulk Electric System (BES) generating resource(s).

4.2.1.2 BES GSU transformer(s).

4.2.1.3 High side of the generator-connected unit auxiliary transformer installed on BES generating resource(s). *Aux transformers that are connected between the high side terminals of the generator's GSU and the BES Interconnection. Unit auxiliary transformer(s) (UAT) that supply overall auxiliary power necessary to keep generating unit(s) online. These transformers are variably referred to as station power, unit auxiliary transformer(s) (UAT), or station service transformer(s) used to provide overall auxiliary power to the generator station when the generator is running.*

4.2.1.4 Individual d Dispersed power producing resources identified in the BES Definition, Inclusion I4.

4.2.1.5 Elements utilized in aggregation of the dispersed power producing resources. (Rationale comment - covered in 4.2.1.4).

4.2.1.6 Collector transformer of resources identified in the BES Definition, Inclusion I4. (Rationale comment - What transformers are these? If they are part of the <100kV collector system then they are out of scope. Per I4, there is no indication of "collector transformer(s)". If this is the GSU then it is covered in 4.2.1.2.)

Proposed requirement R4: In keeping with the intent of the current Standards Efficiency Review Project, R4 is not required within the proposed Standard as the capturing of data is redundant. The NSRF believes this can be captured under currently enforceable MOD-032-1, R2 which requests data developed by the PC and TP in R1.

Per the webinar, the SDT stated that Facilities 4.2.1.5 "Elements utilized in aggregation of the dispersed power producing resources" reads the same as PRC-025-2. The NSRF disagrees with this statement. This SDT is now expanding both PRC-025-2 and proposed PRC-024-3 to include items that make up the "collector systems", which is directly against the FERC Approved definition of Inclusion I4. When the SDT states 4.2.1.5 is directly related to PRC-025-2 and has the same intentions, the NSRF strongly disagrees. When applying the FERC approved definition of Inclusion I4 and 4.2.1.5 of PRC-024-3 (or PRC-025-2) collector system items ARE NOT applicable to either Standard.

Likes 0

Dislikes 0

Response

Steven Rueckert - Western Electricity Coordinating Council - 10

Answer

Document Name

Comment

It may have been the intent of the drafting team to make changes so that the standard was technology neutral, but the potential requirement for synchronous generator owner to have to make change that were never necessary in the past, to address an issue with the inverter-based resources does not seem technology neutral.

Likes 1

Tarantino Joe On Behalf of: Arthur Starkovich, Sacramento Municipal Utility District, 4, 1, 5, 6,

Dislikes 0

Response

Alex Chua - Pacific Gas and Electric Company - 1,3,5

Answer

Document Name**Comment**

Footnote 5 : "Excludes limitations that are caused by the setting capability of the generator frequency and voltage protection relays themselves but does not exclude limitations originating in the equipment that they protect"

An older generator uses an electromechanical auxiliary relay for undervoltage protection. It is original equipment installed with the facility more than 30 years ago. There are no settings available on this relay. Similar to other auxiliary relays, when voltage dips below the drop out voltage, contacts would latch and trip the unit. The dropout characteristic of his relay does not meet PRC-024.

Would this case be considered an equipment limitation for PRC-024? We believe it does as it is original equipment with the plant and there is no language in the existing standard stating that new equipment needs to be installed. When new equipment is required (e.g. PRC-002 and PRC-025), a longer implementation period is accounted for.

Likes 0

Dislikes 0

Response

Scott Berry - Scott Berry On Behalf of: Jack Alvey, Indiana Municipal Power Agency, 1, 4; - Scott Berry

Answer**Document Name****Comment**

The two bullets points under Requirement R1 in the current approved standard for PRC-024 should not be deleted. These should be legit reasons to trip off the unit in the "no-trip" zone.

-Generating unit(s) may trip if the protective functions (such as out-of-step functions or loss-of-field functions) operate due to an impending or actual loss of synchronism or, for asynchronous generating units, due to instability in power conversion control equipment.

-Generating unit(s) may trip if clearing a system fault necessitates disconnecting (a) generating unit(s).

For this standard to be more than just about relay setpoints or maybe inverter setpoints, entities may be forced to model their plants. This is a very expensive item and there is no guarantees that even the model will be accurate. The standard should only be about relay setpoints and if the SDT wants to add solar inverters then it needs to be very specific about what control systems and setpoints in those control systems.

Likes 0

Dislikes 0

Response

Don Schmit - Nebraska Public Power District - 1,3,5

Answer

Document Name

Comment

NPPD supports MRO NSRF comments.

Likes 0

Dislikes 0

Response

Kim Thomas - Duke Energy - 1,3,5,6 - FRCC,SERC,RF, Group Name Duke Energy

Answer

Document Name

Comment

No.

Likes 0

Dislikes 0

Response

Jeremy Voll - Basin Electric Power Cooperative - 1,3,5,6

Answer

Document Name

Comment

Support the MRO NSRF Comments

Likes 0

Dislikes 0

Response

RoLynda Shumpert - SCANA - South Carolina Electric and Gas Co. - 1,3,5,6 - SERC

Answer

Document Name

Comment

SCANA- South Carolina Electric and Gas (Dominion Energy South Carolina) is in agreement with comments from Sean Bodkin (Dominion Energy).

Likes 0

Dislikes 0

Response

Tom Hanzlik - SCANA - South Carolina Electric and Gas Co. - 1

Answer

Document Name

Comment

I agree with the comments submitted by Sean Bodkin-Dominion

Likes 0

Dislikes 0

Response

Richard Jackson - U.S. Bureau of Reclamation - 1

Answer

Document Name

Comment

Reclamation requests clarification of the rationale in allowing the Transmission Planner to make less stringent voltage settings than those required by Attachment 2.

In the interest of developing completely clear, unambiguous, grammatically correct Requirements, R3 could be better stated as:

Each Generator Owner or Transmission Owner shall document each known regulatory or equipment limitation that prevents an applicable generating resource(s) (unit) with generator frequency or voltage protection from meeting the protection setting criteria in Requirements R1 or R2. Documentation includes (but is not limited to) study results, experience from an actual event, or manufacturer's advice.

The comment above can also be applied to R4. R4 is not very clear and may be providing an opportunity for entities to manipulate information to avoid complying. Recommend rewriting to clear up when and what processes allow for deviation from transmitting the setting information.

Likes 0

Dislikes 0

Response

Shirley Mathew - Austin Energy - 5**Answer****Document Name****Comment**

None

Likes 1

Austin Energy, 3, Preston W. Dwayne

Dislikes 0

Response**Allen Schriver - NextEra Energy - 5****Answer****Document Name****Comment**

Comments: The SDT should also consider the following:

- Control systems are not calibrated like protective relays, nor are they stand-alone discrete devices.

- The industry has been successfully working with the manufacturers to make programming changes to resolve the issue per the NERC Alerts.

- The first issue of miscalculating frequency has been resolved by the industry, and there have been no instances of reoccurrence.

- Following the second alert, when inverters were tripping in the “no trip” zone, control changes were implemented for those inverters capable of being changed.

- Inverter control systems sense the voltage and frequency at the inverter terminals and will initiate momentary cessation to protect the inverter. While the POI voltage may be within the PRC-024 curve, inverters can still be impacted by voltage spikes due to switching on the low side of the GSU.

- The IRPTF is currently writing a Reliability Guideline: Improvements to Interconnection Requirements for BPS Connected Inverter-Based Resources (IBRs) which will detail the performance requirements per the PRC-024 curves and cover all IBRs above distribution level. Recommendations from this guideline should be taken into consideration as part of the Standard’s requirements.

Likes 0

Dislikes 0

Response**Chris Scanlon - Exelon - 1****Answer****Document Name**

Comment

The proposed PRC-024-3, Section 4.2.1.5 language, "Elements utilized in aggregation of the dispersed power producing resources.", is a broad statement. The statement appears to be bringing the non-BES components of Inclusion 4, previously included as PRC-024-2 Footnote 2, into the scope of this standard. If this is the intention Exelon suggests:

"Elements utilized in the aggregation of the dispersed power producing resources, as identified in BES Definition I4, from the individual BES resource to the point of aggregation, as identified in BES Definition I4.

Section 4.2.1.5 as currently proposed is sufficiently broad to potentially include rooftop solar and other similar distribution systems resources. Exelon suggests the more narrow statement based on BES Definition I4 to avoid confusion.

Exelon, Segments 1, 3, 5, 6

Likes 0

Dislikes 0

Response

Scott Langston - Tallahassee Electric (City of Tallahassee, FL) - 1

Answer

Document Name

Comment

Regarding embedded frequency protection, it is not clear if generator speed signals that result in the trip of a unit are included. TAL believes this question should be addressed in the standard given that speed is directly related to frequency.

Likes 0

Dislikes 0

Response

Pamela Hunter - Southern Company - Southern Company Services, Inc. - 1,3,5,6 - SERC, Group Name Southern Company

Answer

Document Name

Comment

The elimination of footnote 1 implies that GOs are are required to activate frequency and voltage protective relaying or protection systems where they currently may not be doing so. The footnote made it clear that the standard did not require these elements to be installed or activated on the generating unit. Additionally, the associated documents listed in section E are unnecessarily referened in the standard. The two NERC alerts resulting from the Blue Cut and Canyon fire investigations have issued many recommendations to GO's for addressing the undesired behavior of the solar powered inverter based resources. Southern Company is implementing each of the inverter parameter adjustments recommended where the hardware allows,

and believes that a national reliability standard is not necessary to accomplish the desired changes to the plant configurations to minimize the undesirable and unnecessary power production interruptions.

Likes 0

Dislikes 0

Response

Jodirah Green - ACES Power Marketing - 1,3,4,5,6 - MRO,WECC,Texas RE,SERC,RF, Group Name ACES Standard Collaborations

Answer

Document Name

Comment

Thank you for the opportunity to comment.

Likes 0

Dislikes 0

Response

Rachel Coyne - Texas Reliability Entity, Inc. - 10

Answer

Document Name

Comment

Texas RE has the following additional comments:

- Texas RE requests clarification on Footnote 5 question regarding equipment limitations for wind turbines: do wind turbines equipment limitations include “smart crowbar” equipment limitations, UPS for the turbine control system, and tower vibration limits?
- Including the phrase “experience from an actual event” as allowable evidence in Measure M3 for a regulatory or equipment limitation could imply that the limitation could occur during the event. The intent of the standards is that limitations shall be documented prior to an event occurring.
- Regarding VSLs - Although the wording is clear, this reviewer is uncertain how the Severe VSL for R3 can be enforced: “...failed to document any known non-protection system equipment limitation...” There would have to be documentation to demonstrate that the entity knows about the limitation.

Likes 0

Dislikes 0

Response

Alyssa Hubbard - SCANA - South Carolina Electric and Gas Co. - 5

Answer

Document Name

Comment

I am in agreement with comments submitted by Sean Bodkin-Dominion.

Likes 0

Dislikes 0

Response

Douglas Webb - Douglas Webb On Behalf of: Allen Klassen, Westar Energy, 6, 3, 1, 5; Bryan Taggart, Westar Energy, 6, 3, 1, 5; Derek Brown, Westar Energy, 6, 3, 1, 5; Grant Wilkerson, Westar Energy, 6, 3, 1, 5; James McBee, Great Plains Energy - Kansas City Power and Light Co., 1, 3, 6, 5; Jennifer Flandermeyer, Great Plains Energy - Kansas City Power and Light Co., 1, 3, 6, 5; John Carlson, Great Plains Energy - Kansas City Power and Light Co., 1, 3, 6, 5; Marcus Moor, Great Plains Energy - Kansas City Power and Light Co., 1, 3, 6, 5; - Douglas Webb, Group Name Westar-KCPL

Answer

Document Name

Comment

Comments: Kansas City Power & Light Company and Westar endorses comments submitted by EEI member companies.

Likes 0

Dislikes 0

Response

Todd Bennett - Associated Electric Cooperative, Inc. - 3, Group Name AECI

Answer

Document Name

Comment

AECI supports the comments submitted by ACES

Likes 0

Dislikes 0

Response

Answer

Document Name

Comment

The NSRF has the following recommendations:

The SDT could consider the following modification to Section 4.2 to add clarity (strikethrough is deleted text while italics is added text):

4.2. Facilities:

4.2.1 Frequency, voltage or volts per hertz protection *relays, software controls, firmware controls*, including frequency or voltage protective functions within control systems that provide tripping or momentary cessation signals to all or part of the generating resource, applied to the following:

4.2.1.1 Bulk Electric System (BES) generating resource(s).

4.2.1.2 BES GSU transformer(s).

4.2.1.3 High side of the generator-connected unit auxiliary transformer installed on BES generating resource(s). *Aux transformers that are connected between the high side terminals of the generator's GSU and the BES Interconnection. Unit auxiliary transformer(s) (UAT) that supply overall auxiliary power necessary to keep generating unit(s) online. These transformers are variably referred to as station power, unit auxiliary*

{C}1. with more stringent voltage boundaries for the No Trip Zone. Do you agree with this proposed Quebec Variance? If not, please provide your rationale.

Yes

No

Comments: N/A for the NSRF members.

{C}2. Do you agree with the proposed Implementation Plan? If not, please provide your rationale.

Yes

No

Comments: There may be substantial retesting and replacements to comply with this proposed Standard. The NSRF recommends a 24 month implementation plan as this will give Entities planning time for maintenance outages and for budget forecasting purposes.

{C}3. Do you agree that the proposed modifications provide a cost-effective means of addressing issues in the SAR? If not, please provide an alternative, more cost-effective manner in which to achieve at least an equivalent level of reliability.

Yes

No

Comments: The NSRF believes there may be substantial cost associated with this Standard but cannot state exactly what those cost are as this is the first interaction of the proposed Standard. See question 9.

{C}4. If you have any additional comments on themes that have NOT already been addressed in the proceeding questions on this comment form, please provide them here.

Comments:

The NSRF has the following recommendations:

The SDT could consider the following modification to Section 4.2 to add clarity (strikethrough is deleted text while italics is added text):

4.2. Facilities:

4.2.1 Frequency, voltage or volts per hertz protection *relays, software controls, firmware controls*, including frequency or voltage protective functions within control systems that provide tripping or momentary cessation signals to all or part of the generating resource, applied to the following:

4.2.1.1 Bulk Electric System (BES) generating resource(s).

4.2.1.2 BES GSU transformer(s).

4.2.1.3 High side of the generator-connected unit auxiliary transformer installed on BES generating resource(s). *Aux transformers that are connected between the high side terminals of the generator's GSU and the BES Interconnection. Unit auxiliary transformer(s) (UAT) that supply overall auxiliary power necessary to keep generating unit(s) online. These transformers are variably referred to as station power, unit auxiliary transformer(s) (UAT), or station service transformer(s) used to provide overall auxiliary power to the generator station when the generator is running.*

4.2.1.4 Individual d Dispersed power producing resources identified in the BES Definition, Inclusion I4.

4.2.1.5 Elements utilized in aggregation of the dispersed power producing resources. (Rationale comment - covered in 4.2.1.4).

4.2.1.6 Collector transformer of resources identified in the BES Definition, Inclusion I4. (Rationale comment - What transformers are these? If they are part of the <100kV collector system then they are out of scope. Per I4, there is no indication of "collector transformer(s)". If this is the GSU then it is covered in 4.2.1.2.)

Proposed requirement R4: In keeping with the intent of the current Standards Efficiency Review Project, R4 is not required within the proposed Standard as the capturing of data is redundant. The NSRF believes this can be captured under currently enforceable MOD-032-1, R2 which requests data developed by the PC and TP in R1.

Per the webinar, the SDT stated that Facilities 4.2.1.5 “Elements utilized in aggregation of the dispersed power producing resources” reads the same as PRC-025-2. The NSRF disagrees with this statement. This SDT is now expanding both PRC-025-2 and proposed PRC-024-3 to include items that make up the “collector systems”, which is directly against the FERC Approved definition of Inclusion I4. When the SDT states 4.2.1.5 is directly related to PRC-025-2 and has the same intentions, the NSRF strongly disagrees. When applying the FERC approved definition of Inclusion I4 and 4.2.1.5 of PRC-024-3 (or PRC-025-2) collector system items ARE NOT applicable to either Standard.

Likes 0

Dislikes 0

Response

Bette White - AES - Indianapolis Power and Light Co. - 3

Answer

Document Name

Comment

IPL has no other comments

Likes 0

Dislikes 0

Response

Ruida Shu - Northeast Power Coordinating Council - 1,2,3,4,5,6,7,8,9,10 - NPCC, Group Name RSC no Dominion and Con Ed

Answer

Document Name

Comment

We congratulate the SDT on making practical improvements, like replacing POI with the high side of the main output transformers, to this standard.

The Facilities section can be consolidated. There are currently redundancies in section 4.2.1. The following Facilities can be struck:

4.2.1.2 BES GSU transformer(s). This is part of the BES Generating resource so it is captured in 4.2.1.1.

4.2.1.4. Individual dispersed power producing resources identified in the BES Definition, Inclusion I4. This is a BES generating resource so it is captured in 4.2.1.1.

4.2.1.6 Collector transformer of resources identified in the BES Definition, Inclusion I4. This is part of the BES generating resource in Inclusion I4, so for the same reasons as striking, 4.2.1.2 and 4.2.1.4., it is captured in 4.2.1.1

We suggest that the Facilities section could be simplified. We do not believe that it is necessary to include the BES applicability language within the standard, since the standard should only be applicable to the BES.

We suggest adding the NPCC Region's Frequency No Trip Boundary "Thresholds for Setting Underfrequency Trip Protection for Generators" to the Supplemental Material section of the standard. Please see PRC-006-NPCC for reference.

Likes 0

Dislikes 0

Response

Richard Vine - California ISO - 2

Answer

Document Name

Comment

The California ISO supports the comments as submitted by the ISO/RTO Council Standards Review Committee (SRC)

Likes 0

Dislikes 0

Response

Mark Gray - Edison Electric Institute - NA - Not Applicable - NA - Not Applicable

Answer

Document Name

Comment

EI member companies find the Applicability section of proposed Reliability Standard PRC-024-2 to be confusing and complex. While we appreciate SDT efforts to be thorough, we do not believe that that references to the BES definition inclusions or exclusions are needed and may even expand meaning of some parts of the BES definition. For example, Section 4.2.1.5 state that "[e]lements utilized in aggregation of the dispersed power producing resources" would be in scope, which we believe is an inappropriate expansion of the BES definition. We also do not see a need for the

inclusion of underlying facilities associated with the applicable protection systems (e.g., GSUs, generating resources, auxiliary transformers, dispersed power producing resources, and collector transformers). For this reason, we offer the following as an alternative for SDT consideration.

4. Applicability

4.1. Functional Entities

4.1.1 Generator Owners

4.1.2 Transmission Owners (*EEl disagrees with including TOs, see EEl's comments to Question 5 above*)

4.2 Exemptions

4.2.1 Plant auxiliary equipment protection systems

4.3 Facilities

4.3.1 Generator frequency protective relays (or functionally equivalent devices contained within a generating resource's control system)

4.3.2 Generator voltage protective relays (or functionally equivalent devices contained within a generating resource's control system)

Likes 0

Dislikes 0

Response

Armin Klusman - CenterPoint Energy Houston Electric, LLC - 1 - Texas RE

Answer

Document Name

Comment

CenterPoint Energy Houston Electric, LLC supports the comments submitted by the Edison Electric Institute.

Likes 0

Dislikes 0

Response

Kagen DelRio - Kagen DelRio On Behalf of: doug white, North Carolina Electric Membership Corporation, 4, 3, 5; John Lemire, North Carolina Electric Membership Corporation, 4, 3, 5; Robert Beadle, North Carolina Electric Membership Corporation, 4, 3, 5; - Kagen DelRio

Answer

Document Name

Comment

NCEMC supports the comments submitted by ACES

Likes 0

Dislikes 0

Response

Charles Yeung - Southwest Power Pool, Inc. (RTO) - 2, Group Name SRC

Answer

Document Name

Comment

Evaluating Protection Settings

It is unclear whether the Evaluating Protection Settings section on page 21 of the redline proposed Standard constitutes one or more requirements in connection with the evaluation of voltage protection settings. Are these additional compliance requirements that should therefore be referred to in or made a part of the main body of the proposed Standard? Is a study being required in connection with Requirement R2? If so, the SDT should incorporate a specific requirement in the proposed standard in order to eliminate confusion and ambiguity. The specific requirement should articulate (1) Responsible Entities shall perform a study and (2) the mandatory components of the study.

Use of the term “generating resource”

The SDT should use “generator” or “generating Facility” instead of “generating resource” throughout the proposed Standard in order to conform to common usage in the standard.

Breadth of Requirement R3

We believe the equipment limitation exception to Requirements R1 and R2 that is contained in Requirement R3 is too broad and can be misapplied. As currently worded, the proposed Standard allows generating Facilities to be designed to be exempt from Requirements R1 and R2, thereby eliminating any compliance obligation to PRC-024. We suggest adding an implementation period to allow all facilities to meet the protection setting criteria.

Likes 0

Dislikes 0

Response

Constantin Chitescu - Ontario Power Generation Inc. - 5

Answer

Document Name

Comment

OPG supports RSC’s comments, and has the following additional comments:

As per PRC-024-3 requirement R1 the Eastern Interconnection Generator Owner shall set the generator frequency protections in accordance with Eastern Interconnection Boundaries (Attachment 1)

As per PRC-006-NpCC-1 Requirement R13 Each Generator Owner shall set each generator underfrequency trip relay, if so equipped, below the appropriate generator underfrequency trip protection settings threshold curve in Figure 1.

It appears that there is a gap between the compliance requirements of these two standards with respect to underfrequency protection settings that warrants SDT discrepancy review.

Likes 0

Dislikes 0

Response

NERC

NORTH AMERICAN ELECTRIC
RELIABILITY CORPORATION

PRC-024-3 Draft 1 Summary Comment Responses

Project 2018-04 Modifications to PRC-024-2

RELIABILITY | RESILIENCE | SECURITY



3353 Peachtree Road NE
Suite 600, North Tower
Atlanta, GA 30326
404-446-2560 | www.nerc.com

Table of Contents

Preface	iii
Executive Summary.....	iv
Introduction	v
Background.....	v
Chapter 1 : Responses to Protection Modification.....	1
Question # 1	1
Chapter 2 : Point of Interconnection	3
Question # 2	3
Chapter 3 : Momentary Cessation in the No Trip Zone	4
Question # 3	4
Chapter 4 : Momentary Cessation – General.....	6
Question # 4	6
Chapter 5 : Transmission Owners that Own/Apply Protection	8
Question # 5	8
Chapter 6 : Plant Auxiliary Protection Systems.....	9
Question # 6	9
Chapter 7 : Modifications to Charts and Figures	11
Question # 7	11
Chapter 8 : Quebec Interconnection Variance	13
Question # 8	13
Chapter 9 : Implementation Plan.....	14
Question # 9	14
Chapter 10 : Cost Effectiveness.....	15
Question # 10	15
Chapter 11 : Miscellaneous Comments	16
Question # 11	16

Preface

Electricity is a key component of the fabric of modern society and the Electric Reliability Organization (ERO) Enterprise serves to strengthen that fabric. The vision for the ERO Enterprise, which is comprised of the North American Electric Reliability Corporation (NERC) and the six Regional Entities (REs), is a highly reliable and secure North American bulk power system (BPS). Our mission is to assure the effective and efficient reduction of risks to the reliability and security of the grid.

Reliability | Resilience | Security
Because nearly 400 million citizens in North America are counting on us

The North American BPS is divided into six RE boundaries as shown in the map and corresponding table below. The multicolored area denotes overlap as some load-serving entities participate in one Region while associated Transmission Owners/Operators participate in another.

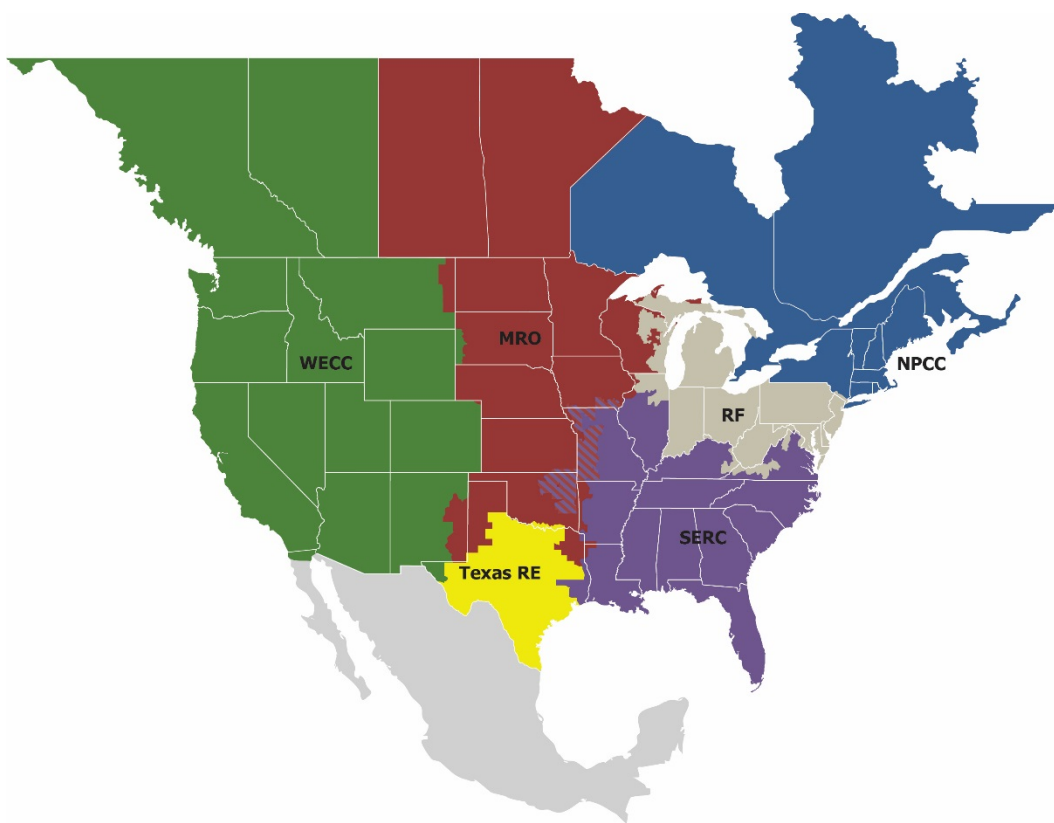

MRO	Midwest Reliability Organization
NPCC	Northeast Power Coordinating Council
RF	ReliabilityFirst
SERC	SERC Reliability Corporation
Texas RE	Texas Reliability Entity
WECC	Western Electricity Coordinating Council

Executive Summary

On November 27, 2018, the NERC Operating Committee (OC) and Planning Committee (PC) submitted a Standard Authorization Request (SAR) prepared by the Inverter-Based Resource Performance Task Force (IRPTF), which reports to the OC and PC.

Based off the analyses of the [Blue Cut Fire](#) and [Canyon 2 Fire](#) disturbances in southern California along with the development of the [PRC-024-2 Gaps Whitepaper](#), the IRPTF identified potential modifications to PRC-024-2 to ensure that inverter-based generator owners, operators, developers, and equipment manufacturers understand the intent of the standard in order for their plants to respond to grid disturbances in a manner that contributes to the reliable operation of the BPS.

Reliability Standard PRC-024-3 contains a series of revisions and clarifications intended to help ensure that inverter-based resources respond to grid disturbances in a manner that contributes to the reliable operation of the Bulk-Power System.

In addition, the standard includes a Regional Variance for the Quebec Interconnection and related revisions to clarify the applicability of the standard in that Interconnection.

Introduction

Background

Project Name:	2018-04 Modifications to PRC-024-2 PRC-024-3 (Draft 1)
Comment Period Start Date:	4/17/2019
Comment Period End Date:	5/31/2019
Associated Ballots:	2018-04 Modifications to PRC-024-2 PRC-024-3 IN 1 ST

There were 69 sets of responses, including comments from approximately 169 different people from approximately 125 companies representing 10 of the Industry Segments as shown in the table on the following pages.

All comments submitted can be reviewed in their original format on the [project page](#).

If you feel that your comment has been overlooked, please let us know immediately. Our goal is to give every comment serious consideration in this process. If you feel there has been an error or omission, you can contact Senior Director of Engineering and Standards [Howard Gugel](#) (via email) or at (404) 446-9693.

Chapter 1: Responses to Protection Modification

Question # 1

The standard drafting team (SDT) replaced “protective relays” to “protection” throughout the standard to include relays, settings in applicable control systems, as well as other types of voltage and frequency protection devices. Do you agree with these modifications? If you do not agree, or if you agree but have comments or suggestions, provide your recommendation, explanation, and proposed modification

Summary

Several commenters requested an official NERC definition for a “protection”. Many commenters suggested that protection functions within control systems (e.g. excitation system, governor control system, inverter control system, etc.) should not be included within the standard. Also, we received various comments on protection systems in plant auxiliary loads indirectly tripping generation resources. Also some commented that protection should only respond to electrical signals and directly trip the generating resource.

Response

The SDT agrees that this standard should only apply to measured electrical quantities and should exclude devices that respond to mechanical measurements. The SDT modified the Facilities section to include this exclusion. The SDT has modified the Facilities Section to adequately describe “protection” meant to be included and has added footnotes with specific language to Requirements R1 and R2 to further clarify.

Summary

The standard’s language needs to be more generic. Various Inverter Based Resource control systems and protection systems design features (not just “protection”) have demonstrated the ability to cause curtailment of output for perturbations of frequency and voltage. The standard needs to require that none of these design features can cause Inverter Based Resource facilities to curtail output for frequency and voltage deviations within the limits specified in this standard.

Response

Regulations of power output is geared towards a performance-based standard. PRC-024 is not a performance-based standard. Therefore, this is outside the scope of the standard.

Summary

A comment stated that this is a Protective Relay Standard which should not include control systems. It is believed that the SAR does not recommend inclusion of control systems. It is also believed that control systems are designed by control engineers are to ensure required performance while operating within the equipment limits.

Response

The SDT believes that portions of control systems act like protection by tripping the generating resource or causing it to cease injecting current and therefore needs to be addressed by this Standard. The PRC family of Standards apply to protection and control. These controls are already in scope via PRC-024-2, Footnote

1

Summary

A comment sought clarification for requirement 4.2.1.5 “Elements utilized in aggregation of the dispersed power producing resources” of what could be an “elements” for applicability of the PRC-024 requirements. Dispersed power resources which operate in aggregate utilize a controller which has the capability to automatically trip the resources under certain high-side system frequency and voltage conditions. The settings for these controllers should also be considered as being applicable to the PRC-024 requirements regardless of their ownership.

Response

The SDT agrees that the protection on the elements up to the generating resource’s connection to the BES should be included in the scope of PRC-024-3 and be set to not trip the generating resource within the “No Trip Zone”.

Chapter 2: Point of Interconnection

Question # 2

To address confusion regarding “at the point of interconnection,” the team replaced it with the phrase, “at the high side of the generator step-up or collector transformer.” Do you agree with this clarifying change? If not, please provide an alternative suggestion

Summary

Several commenters noted that they do not consider the high side of the GSU or collector transformer to always be the correct location to consider a voltage excursion when setting voltage protection. They believe that either the generator side terminal or end of the generator tie line would be more appropriate.

Response

The SDT did not make a substantive change to the existing Standard but rather reorganized language for clarity. The previous version of the Standard stated that the voltage excursion occurred at the point of interconnection and then later defined the point of interconnection as the high side of the GSU in a footnote. The SDT does not have technical justification to change that location of the voltage excursion.

Summary

Several commenters noted that sites may have multiple stages of generator step up or collector transformers and that the way that the draft is currently written, it is unclear which transformer should be used when analyzing voltage relay settings.

Response

The SDT agrees with the comments that the way the Standard is currently written, it is unclear. The SDT has clarified that for the purposes of this standard, for generating resources with multiple stages of step up to reach interconnecting voltage, this is the high side of the transformer with a low side below 100kv and a high side 100kv or above.

Summary

Several commenters noted that it was unclear what was meant by collector transformer and generator step up transformer and if they applied to non-BES equipment identified in Applicability Section 4.2.1.5. Commenters suggested that they may benefit from an illustration.

Response

While the SDT only moved language from a footnote to the requirement language, they did agree that clarity can be added to specifically identify what transformers are meant. This can be accomplished by the same solution to the previous set of comments above about sites that have multiple stages of step up prior to interconnecting voltage.

Chapter 3: Momentary Cessation in the No Trip Zone

Question # 3

The SDT modified Requirements R1 and R2 to not allow momentary cessation, in addition to tripping, in the “no trip zone.” Do you agree that momentary cessation should not be allowed in the no trip zone? If not, please provide your rationale.

Summary

Many responders recommended that the SDT define the term Momentary Cessation before using it in a Standard. Many also noted that this term is not in the NERC Glossary

Response

The SDT agrees that clarity is required around the term Momentary Cessation. The term has been eliminated from the standard and replaced with “or cease injecting current.”

Summary

One entity responded that the SDT needs to consider that momentary cessation is required for certain FACTS devices, e.g. STATCOMs or SVCs because unlike solar PV, there is no source behind the STATCOM.

Response

This standard is applicable to generating resources, which does not include FACTS devices such as STATCOMs, etc.

Summary

One entity referenced the proposed revision to footnote 5 and stated that it could preclude the exemption of legacy inverters not capable of meeting the proposed revisions to the standard.

Response

The SDT recognizes that this might cause confusion and has modified the footnote accordingly.

Summary

Several respondents expressed concern that there was no exemption for older equipment that was not able to meet the proposed new requirements. There is concern that inverters initiate momentary cessation due to voltages measured at their terminals. They initiate momentary cessation to protect the power electronics. The voltages seen at the terminals may be due to switching spikes on the low side of the GSU which may not be reflected in the voltage at the point of interconnection.

Response

The SDT notes that existing R3 in the standard provides for exemptions, and that this has not been eliminated in the proposed revisions.

Summary

Two respondents indicated that momentary cessation is a controls system response and not a protection system response, and therefore out of the scope of the proposed revisions to the standard.

Response

The SDT notes that the existing footnote 1 specified that protective relaying, “ including multi-function protective devices or protective functions within control systems that directly trip or provide tripping signals...” is within the scope of the standard. The SDT moved the requirements already imbedded in the existing footnote into the body of the standard for clarity purposes.

Summary

There was a concern that requiring a generating facility to not trip due to impending loss of synchronism, actual loss of synchronism, or due to instability in power conversion control equipment may exacerbate the system condition which originated the disturbance. That is, not allowing a unit to trip when it needs to trip in those instances can make the situation worse.

Response

The SDT notes that this standard is a generating resource protection setting standard and not a generating resource performance standard. Tripping or ceasing to inject current for the listed events is allowed.

Summary

Several respondents indicated that the momentary cessation question is confusing because it does not address the exceptions in R1 and R2.

Response

The SDT notes that existing R3 in the standard provides for exemptions, and that this has not been eliminated in the proposed revisions.

Summary

One respondent commented that momentary cessation is necessary to protect the inverter power electronics.

Response

The SDT notes that based on input from two inverter manufacturers, present inverter technology and control is such that the need for inverters to cease injecting current within the “No Trip Zone” is no longer a design requirement.

Summary

One respondent suggested using the effective date of the generator Interconnection Agreement as the basis for determining which inverters should be subject to exemption under R3.

Response

The SDT believes that older legacy inverters are covered under the R3 exemption and that this is implementation provides more flexibility for the generator as opposed to imposing an effective date for the Interconnection Agreement.

Chapter 4: Momentary Cessation – General

Question # 4

Do you agree that “momentary cessation” – like “tripping” – is well understood by industry? If not, please provide your rationale

Summary

Several commenters noted that momentary cessation is not a term sufficiently and consistently understood by industry. Many commenters suggested that the SDT define the term in the standard or NERC Glossary of Terms to ensure consistency in application.

Three commenters noted that momentary cessation is not well understood and are concerned how future compliance enforcement will interpret momentary cessation. Commenters suggested that the SDT draft a definition for momentary cessation in order to improve consistency in future compliance enforcement activities. Other commenters noted that momentary cessation is not the same as tripping. Tripping is associated with a mechanical action that will disconnect the generator resource from the grid via an interrupting device. Momentary cessation is an inverter “open state” of an electronic component where the inverter is not producing current and there is no interrupting device disconnecting the generator resource.

One commenter noted that momentary cessation is not well understood, and language in the standard needs to be generic enough to cover any design features that can cause facility curtailment for any reason during frequency and voltage disturbances. Another commenter noted that although the term momentary cessation may be well understood by entities that own inverter-based resources, including time parameter may provide additional clarity for those that do not currently these resources. It’s not clear if a reduction in current for any reason is considered “momentary cessation” or only when it involves blocking.

Response

In reviewing the comments, the SDT determined that rather than create a define term for momentary cessation, a description could be included in the requirement. For example, “...shall set its setting such that the generating resource does not trip OR cease injecting current within the No Trip Zone...” The SDT agrees that momentary cessation is illustrated as a period where an inverter ceases to inject current (no current injected), which is also referred to as “blocking”.

Summary

One commenter noted that momentary cessation is not the same as tripping and is much closer in comparison to a control system limiter rather than a generator protection system. Including this control system action does not fit the title and purpose of this standard, and would transform the standard from a protection setting standard to a ride-through or plant performance standard. One commenter noted that blocking is well understood term among IBR manufactures, however it seems that momentary cessation also covers the period after blocking. It’s not clear if a reduction in current for any reason is considered “momentary cessation” or only when it involves blocking.

Response

In reviewing the comments, the SDT believes that protection function within a control system that can potentially trip or cause a resource to cease injecting current, based on frequency and voltage excursions

does fit the purpose of this standard. Also, protective functions within a control system were in scope in the original version of the standard as part of footnote 1, and was added in the body of the standard by the SDT for clarity and to add emphasis. The SDT has modified the Facilities Section to adequately describe the “protection” meant to be included and has added footnotes with specific language to Requirements to further clarify.

Chapter 5: Transmission Owners that Own/Apply Protection

Question # 5

The SDT was apprised that, in some instances, the TO may own the GSU or collector transformers. As such, TOs were added to the applicable entity for cases where they may own a GSU or collector transformers with frequency and voltage protection enabled. Do you agree with the addition of TOs who own a GSU or collector transformer to the applicable entities? If not, please provide your rationale.

Summary

Many commenters noted that PRC-024 was developed to ensure that protective relay settings were established such that generator resources remain connected to the grid during defined voltage and frequency transients and that mere ownership of a GSU or collector transformer does not constitute an integral part of the affected relay protection. Many commenters noted that TOs, even if they own GSUs or collector transformers, do not own generator protection relays unless they are already registered as a GO. Many commenters noted that they were unaware of any events where a BES generator failed to meet the requirements of PRC-024 because of GSU or collector transformer owned by a TO. Several other commenters similarly stated that this standard is for generator protection and questioned why protection of any transformers is included in scope. Similarly, one commenter noted that protection for TO owned GSUs or collector transformers is not intended for the protection of generators and including them in scope for this standard results in a shift of compliance burden from the GO to the TO. Finally, two commenters noted the focus should be on generator protection it is unnecessary to include TOs just because they own elements tripped by GO's protective devices.

Response

In response to these comments and the comments received during the PRC-024-3 Supplemental SAR posting, the SDT is no longer proposing to include TOs as an applicable entity in the continent-wide version of the standard. At the request of entities within the Quebec Interconnection, Transmission Owners will be included as an applicable entity for the Quebec Interconnection. The Supplemental SAR did provide for voltage, frequency and Volts/Hz applied on GSUs and UATs to be included in the scope of the standard.

Summary

One commenter stated that TOs that own asynchronous tie lines should also be included in the standard as they also exhibit momentary cessation due to voltage and frequency excursions.

Response

Asynchronous tie lines are outside the scope for applicability of PRC-024. Also, TOs have been removed from the continent-wide version of the standard.

Summary

One commenter noted that there may be instances where one entity owns the transformer and another entity owns the protection and as the standard is currently written, the transformer assets might not be within the scope of the standard.

Response

NERC writes standards to ensure reliable operation of the bulk electric system (BES), and the SDT asserts that if these situations exist, they would be rare and would not pose an impact to the BES.

Chapter 6: Plant Auxiliary Protection Systems

Question # 6

Another intent of the facilities section was to clarify that voltage and frequency protection applied to plant auxiliary equipment is not applicable to the standard. Do you agree it is clear that plant aux equipment is out of scope of PRC-024? If not, please provide your rationale and a proposal.

Summary

Numerous commenters stated that the changes made to the Facilities section did not make it sufficiently clear that plant auxiliary equipment is excluded from the scope of the standard and offered alternative wording for the Facilities section or recommended the inclusion of figures to clarify the scope of equipment to be included in the standard. Numerous commenters requested that an explicit statement of the exclusion of plant auxiliary equipment be added to the Facilities section. One commenter noted that the lack of specificity regarding the inclusion of voltage, frequency, and V/Hz protective functions implemented within control systems could inadvertently include balance of plant equipment such as forced draft fans or boiler feed pumps within the scope of the standard as these components may have such protection enabled within their control system and the trip of which may result in a trip or de-rate of the plant.

Response

In response to these comments, the SDT has added section 4.2.2 which provides a specific exemption of all auxiliary equipment and associated protection from the Applicability of PRC-024-3. Additionally, the SDT has changed the wording of the applicability section to note that only voltage or frequency protection that trips the generating resource directly or provides signals to trip the generating resource or cause it to cease injecting current are in scope.

Summary

Several commenters were confused by section 4.2.1.3 of the Facilities and asked if auxiliary transformers connected between the high side of the GSU and the point of connection to the BES are meant to be included in scope and offered suggested wording comparable to that contained in PRC-025 for clarification for auxiliary transformers to be included as in scope.

Response

In response to these comments the SDT has rephrased that portion of the Facilities section and added a footnote to clarify that only auxiliary transformers connected on the generator bus between the low side of the GSU and the generator terminals are in scope.

Summary

Several commenters questioned the use of the phrase “all or part of a generating resource” in Facilities section 4.2.1. One commenter asked if this meant that de-rates of synchronous resources now falls within the applicability of the standard. Two other commenters noted that the use of “all or part of a generating resource” in section 4.2.1 could be interpreted as including plant auxiliary systems as in scope.

Response

In response to these comments, the SDT rephrased the Applicability Section to eliminate the use of the phrase “all or part of a generating resource” and has added language explicitly stating that plant auxiliary systems are not in scope of PRC-024-3.

Summary

One commenter stated that the proposed inclusion of the high side of unit auxiliary transformer made the exclusion of plant auxiliary equipment unclear and asked for the technical justification for including voltage and frequency protection applied on the high side of UATs within the scope of the standard.

Response

The technical justification for inclusion of voltage and frequency protection provided on the high side of the UAT is that typically there is no breaker provided between the high side of the UAT and the generator bus to which it is connected. As such, any actuation of voltage or frequency protection applied on the high side of the UAT will necessitate tripping the generator and GSU to which it is connected. Most modern microprocessor based transformer protection relays are equipped with voltage, frequency, and volts/Hz elements and these could be set separately from those applied on the generator or GSU and could result in a loss of the generating resource during a voltage or frequency excursion if so applied on the high side of the UAT.

Summary

Several commenters disagreed with the exclusion of plant auxiliary equipment from the scope of the standard if the loss of the specific piece of auxiliary equipment affects the P, Q or V_t output of the plant.

Response

The SAR for PRC-024-3 was to clarify that auxiliary equipment is excluded from the scope of the standard and, therefore, it would be in direct conflict with the SAR to change the standard to include plant auxiliary equipment as in scope.)

Chapter 7: Modifications to Charts and Figures

Question # 7

The SDT made several clarifying changes to the figures and tables (outlined in the SAR) to improve readability and eliminate confusion addressed in the SAR, including: (i) labeling the area outside the “No Trip Zone” as the “May Trip Zone;” (ii) removal of “ride-through” language; (iii) addition of “Minimum Time;” (iv) replacement of “instantaneous” with “0.10” seconds; and (v) clarifying modifications to the Voltage Boundary Clarifications. Do you agree with these modifications? If not, please recommend alternative solution(s)

Summary

Replacement of « instantaneous » with a 0.1 second minimum time - Several commenters interpreted this change as adding an intentional time delay to the protection relays and argued that it would require changing the settings of the generating resources in order to comply with the standard, which would create an unnecessary burden for the GOs.

Response

Changes to the tables supporting the Frequency No Trip Boundary Charts were made by the SDT in order to avoid using the term « instantaneous » and ensure that a minimum time of 100ms is allowed to account for the accurate frequency measurement (especially for IBRs where frequency is derived from PLL). SDT does not intend to introduce any additional delay in where a protective relay is tasked with frequency tripping, since such a device will act on an accurate frequency measurement. The 100ms in Table will ensure such delay, whether actual latency due to relay action or allowing enough time to derive accurate frequency from PLL, is modeled explicitly on modeling world...to be discussed

Summary

Some commenters expressed that the voltages depicted in the No-Trip Boundaries should assume positive-sequence voltage rather than RMS fundamental frequency phase-to-ground or phase-to-phase voltage.

Response

A significant portion of protective relays measure RMS and do not measure positive sequence. The SDT contends that since this is a protection settings standard, RMS is the appropriate voltage to measure. Additionally, the values in the Attachment 2 tables were based on the analyses and studies conducted by WECC on phased quantities and not on positive sequence.

Summary

Many commenters noted that the addition of the phrase “May Trip Zone” may cause more confusion than clarity. One commenter suggested “equipment limitation zone” Other commenters suggested shading the region on the figure. One commenter noted that the drafting team is aware of this shortcoming due to the logarithmic chart.

Response

The SDT has removed the “May Trip” label and has added the following note to the figure: * *The area outside the “No Trip Zone” is not a “Must Trip Zone.”* The SDT asserts that the boundaries and charts are

sufficient and that equipment limitations do not need to be addressed. The SDT believes that the for readability, the chart should remain logarithmic.

Summary

Many commenters noted that The Voltage No-Trip Boundary graph for the Eastern, Western and ERCOT Interconnections stops after 4 seconds and the corresponding table with the data points does not include a « continuous » Minimum Time like in the Frequency Boundary Data Points tables. Commenters have suggested that the graph be expanded beyond 4 seconds to clearly show continuous operation limits.

Response

For the purpose of PRC-024, the voltage curves stop at 4 seconds. PRC-024 is only intended to address voltage excursions up to 4 seconds for the Eastern, Western and ERCOT Interconnections. At that point, the voltage excursion has ended for applicability to PRC-024. Other NERC Reliability Standards address generator voltage operating requirements beyond 4 seconds.

Comment

In Attachment 2, Voltage Boundary Clarifications, item 4 states that the boundary can be adjusted in proportion to frequency. Does this eliminate the possibility of leaving the boundary alone and evaluating the volts per hertz relay at 60Hz?

Response

While the boundary can be adjusted, it is not required.

Comment

In Attachment 2, Voltage Boundary Clarifications, how does item 2. “The boundaries apply to voltage excursions regardless of the type of initiating event” provide clarification? I understand the curves were developed based on event simulations, but for analysis, the Entity is simply plotting the relay curves using assumed loading conditions to assure these curves and thus tripping are not in the “No Trip Zone”. If this statement is attempting to tell the Entity that running a series of event simulations is not enough to ensure compliance, please add more information to the clarification.

Response

The SDT has removed the statement to avoid confusion.

Comment

In Attachment 2, Voltage Boundary Clarifications, item 4 states that the boundary can be adjusted in proportion to frequency. Does this eliminate the possibility of leaving the boundary alone and evaluating the volts per hertz relay at 60Hz?

Response

The SDT has revised Boundary Detail #3 for frequency assumptions to further clarity.

Comment

In Attachment 2, Voltage Boundary Clarifications, item 6 is correct, but is redundant as Table 1 indicates no limitation in voltage setting after 4 seconds. Should item 6 be removed from the document.

Response

The SDT chose to leave the statements to clarify confusion.

Chapter 8: Quebec Interconnection Variance

Question # 8

The SDT added Quebec Interconnection-wide Variance to Requirement R2 with more stringent voltage boundaries for the No Trip Zone. Do you agree with this proposed Quebec Variance? If not, please provide your rationale

Summary

One commenter stated that they believe that the variance language can be sufficiently and effectively handled in the Quebec Interconnect specific figure similar to the frequency "no trip zone" Quebec specific chart and that a separate variance section is not required. Other commenters noted that they did not own facilities in Quebec and therefore had no opinion on the Variance.

Response

The motivation for including the Quebec specific figure in a Regional Variance is indeed related to the different language that is used in Quebec. But it also goes beyond the language. For example, in the Quebec Interconnection, the voltage no trip boundary, in overvoltage, allows Momentary Cessation under specified conditions, which is not allowed in the continent-wide proposed requirement.

Chapter 9: Implementation Plan

Question # 9

Do you agree with the proposed Implementation Plan? If not, please provide your rationale

Summary

Many commenters asserted that 18 months was insufficient. More time was requested for the following reasons:

- The current lack of understanding of the behavior of existing installed equipment with regard to “momentary cessation”
- The original dates for version 1 (and 2) were phased in over a longer period.
- More time needed to (i) obtain funding for and perform an analysis to see if they have compliance gaps and, if so, (ii) obtain funding for the change(s); (iii) complete a design for the change(s); and (iv) implement the changes
- As an example, replacing "instantaneous" language with "0.10 second" requires entities to verify the existing setting to meet this requirement.
- There may be substantial retesting and replacements to comply with this proposed Standard. The NSRF recommends a 24 month implementation plan as this will give Entities planning time for maintenance outages and for budget forecasting purposes.
- More time would allow for communication with the appropriate parties to see how systems would react to the current proposed set points and maybe allow any applicable modeling that may be required. If the standard was truly just adding solar plant inverters, the current proposed implementation plan would be sufficient.
- Consider a longer implementation period than 18 months for the necessary protection scheme changes, implementation and testing of the protection systems associated with the new requirement.
- Transmission asynchronous inerties exhibit the same momentary cessation issues due to voltage and frequency excursions as solar inverters
- Nuclear generating units typically run continuously and therefore implementation would have to be done during a scheduled refueling outage (typically 2 years for a boiling water reactor and 18 months for a pressurized water reactor). The scheduling to implement design changes during refueling outages is typically scoped at least 24 months in advance.

For these reasons, commenters suggested 36, 42, 60, etc. months for the implantation dates; however, many commenters agreed that 24 months would be sufficient.

Response

The SDT has modified the Implementation Plan to include a 24-month compliance date for GOs. The SDT has removed the reference to TOs given the fact that TOs are no longer applicable entities in the continent-wide version of the standard. The SDT has replaced the “.1 second minimum time” value back to “instantaneous.” Also, the term momentary cessation is no longer used in the standard, and the team agrees that industry should understand “cease injecting current” to be functionally equivalent.

Summary

One commenter noted that changes in any protective relay function and/or voltage/frequency control functions on inverters will require additional costs to industry adjusting dynamic models to meet MOD-032 requirements. The

SDT should consider older technology that is incapable of making the changes to be grandfathered and to allow for technical exceptions in order to avoid replacement costs of some equipment.

Response

These equipment limitations are covered under Requirement R3 with the exception of protective relays.

Footnote #4: *"Excludes limitations caused by the setting capability of the frequency and voltage protective relays for the generating resource(s) but does not exclude limitations originating in the equipment that the relays protect or the frequency and voltage protection imbedded in control systems."*

Chapter 10: Cost Effectiveness

Question # 10

Do you agree that the proposed modifications provide a cost-effective means of addressing issues in the SAR? If not, please provide an alternative, more cost-effective manner in which to achieve at least an equivalent level of reliability

Summary

One commenter is concerned that the term "protection" is unclear and could potentially expand the included devices and equipment beyond the intent. Several commenters believe there may be substantial cost associated with this Standard.

Response

The SDT has modified the Facilities Section to adequately describe the "protection" meant to be included and has added footnotes with specific language to Requirements to further clarify. The SDT has also removed TOs from the applicability and has extended the implementation timeline from 18 to 24 months.

Chapter 11: Miscellaneous Comments

Question # 11

If you have any additional comments on themes that have NOT already been addressed in the proceeding questions on this comment form, please provide them here

Summary

Several commenters expressed the need for diagrams like those used in other standards which shown the equipment the standard applies to.

Response

The SDT had chosen to use the BES definition to describe the equipment included in the scope of the standard and has clarified the Facilities section.

Summary

Several commenters expressed that the exclusion of plant auxiliary equipment from the standard is still not clear.

Response

The SDT attempted to exclude the plant auxiliary equipment by adding the Facilities section and limiting the standard to the high side terminals of the UAT; however, an Exclusion section has be added to exclusively exclude the plant auxiliary equipment from the standard.

Summary

Several commenters stated the phrase “Elements utilized in aggregation of the dispersed power producing resources” is too broad and misunderstood. Furthermore, the mixing of this phrase and the BES I4 definition are contradictory

Response

The SDT moved footnote 2 up into the Facilities section. There is no change in the equipment covered in footnote 4 in PRC-024-2 and that described in PRC-024-3 facilities section.

Summary

Some commenters expressed that the standard applies to generator protection only and has no place for inclusion of the GSU or UAT.

Response

The SDT agrees that PRC-024-2 applies specifically to conventional synchronous generators. The inclusion of the IBR in footnote 4 clearly indicates that the generation resource is inclusive of the IBR and all equipment up to the POI (exclusive of plant auxiliary systems). It is in the opinion of the SDT that inclusion of the synchronous generator GSU and HS of the UAT better aligns with the intent of the standard and would remove any gaps where a voltage, frequency or V/Hz protection is applied exclusively to the GSU or HS of the UAT transformer. This intent is already assumed by most protection and control engineers as the damage curves for the GSU, UAT and generator are being considered when setting the V/Hz protection on the generator and coordination between independent V/Hz protection relays or control systems as in AVRs.

In most all cases, the generator is more susceptible to damage than the transformers and by default will protect the GSU and UAT.

Summary

One commenter noted that the listing of voltage, frequency, and volts/hertz relays in the Facilities section is inconsistent with the NERC defined term “Facilities” which refers to “a set of electrical equipment that operates as a single Bulk Electric System Element” and stated this could cause confusion. Another commenter stated that Facilities section 4.2.1.5 expands the BES definition and should not be included. One commenter stated that Momentary Cessation is not a protection function and should not be included within the applicability of the standard.

Response

The SDT does not intend to use the NERC Glossary term of Facilities. Many NERC standards have “Facilities” sections. The only reason Facilities is capitalized is due to the fact that it is a specific section of the Standard. The SDT contends that expanding the BES definition is not in scope of Project 2018-04. The SDT addressed Momentary Cessation issue in questions 3 and 4 above.

Summary

The original draft of PRC-024-1 included, "shall not trip," language, which was replaced by, "set its protective relaying," after GOs pointed out that we can control our relay settings, but no one knows what might happen to take units offline for the massive disturbances of PRC-024 Att.1 and 2 (High/low drum level? High/low furnace pressure? CTG flame-out). PRC-024-3 has undone this pivotally important clarification by requiring that protection be set, "such that the generating resource does not trip." Units may trip regardless of how we set the protection for reasons that are out of scope for the standard and beyond our control. Many CTG protectives in particular are set by the OEM, and often can't be viewed by plant personnel much less adjusted. The, "set its protective relaying," language of PRC-024-2 should be retained.

Response

The SDT believes that it is the entities responsibility to understand their resource’s control system and how it will react to voltage and frequency excursions. The SDT recommends that an entity contact their generator/control system OEM for information about their settings or adjustments to existing settings. Also, see Requirement R3 for more information regarding equipment limitations.

Comment

If a start-up transformer can support station load during times when the unit auxiliary becomes inoperable, e.g., emergencies, is this Standard applicable to the start-up transformer?

Response

The UAT is the only auxiliary transformer in the scope of the standard. Startup transformers are usually fed from the transmission system. If the startup transformer were connected to another units generator bus, it would be considered a UAT and then would be in the scope of the standard.

Comment

It’s unclear in Attachments 1 and 2 whether the lines are in the No Trip Zone of the May Trip Zone. Can the Standard Drafting Team (SDT) please clarify?

Response

The tables specify whether inclusion or exclusion of the boundary lines.

Comment

Seminole reads Attachment 1, Table 1, to not apply to any protection system settings less than 0.10 seconds. For example if we had a setting at .08 sec. that was in the no trip zone, this would not be applicable to this standard, Is this correct?

Response

The SDT has replaced the .1 minimum time to “instantaneous,” so .08 seconds is applicable to the standard.

Comment

In Attachment 1, the low frequency (Hz) values are less than or equal signs until the final frequency. For Attachment 2, the low voltage (pu) points are less than signs with the final voltage being less than or equal. Why is this different? Should we be treating the boundary lines differently between attachments?

Response

There have been no changes from the currently enforceable standard, and the SDT does not have technical justification to make modifications at this time.

Comment

The “Evaluating Protection Settings” section should be modified to coincide with the operating conditions of the generator. The power factor designation should be adjusted to align with whether the generator is underexcited or overexcited. Also, the language should be modified so that it clearly states that an entity may use steady state analysis for a dynamic situation.

Response

The SDT has re-written the “Evaluating Protection Settings” section.

Comment

PRC-024-2 footnote 1 specifically instructed entities to evaluate the V/Hz protection at nominal frequency (60 Hz). In the PRC-024-3 version, this detail was lost the translation of the footnotes into the facilities/requirements section. This will create ambiguity and may cause entities to believe they have to perform dynamic simulations to show compliance with V/Hz protection schemes.

Response

The SDT has added this back into Attachment 2.

Comment

Suggest revising Purpose from “To set generator protection such that generating resource(s) remain connected, continuing to support the BES during defined frequency and voltage excursions” to instead state “To ensure generator protection *is set* such that generating resource(s) remain connected *and continue to support* the BES during defined *durations of off-nominal frequency and voltage.*”

Response

The SDT has modified the purpose statement. “To set protection such that generating resource(s) remain connected during defined frequency and voltage excursions in support of the Bulk Electric System (BES).”

Comment

Section Title: Change from to “Voltage Boundary Clarifications” to instead state “Voltage *and Frequency* Boundary Clarifications” Change from “The boundaries apply to voltage excursions regardless of the type of initiating event” to instead state “The boundaries apply to *off-nominal* voltage *and frequency durations* regardless of the type of initiating event.”

Response

The information in the “Voltage Boundary Clarifications” does not apply to frequency. The SDT does not believe there is a need for clarification in Attachment 1 for frequency.

Comment

Change from “The values in the tables represent the minimum time durations allowed for specified voltage excursion thresholds” to instead state “The values in the tables represent the minimum time durations *required* for specified voltage thresholds.” It may still be advantageous to retain the example here because it is too easy to misconstrue the boundaries as meaning no trip for excursions that remain within the boundaries rather than no trip for time durations at the defined levels.

Response

The SDT believes that the language is clear.

Comment

Change from “The boundaries assume a system frequency of 60 Hertz” to instead state “The boundaries assume a system *base* frequency of 60 Hertz.” Also, please add a “the “to the second sentence to state “When evaluating volts per hertz protection, *the* magnitude of the high voltage boundary can be adjusted in proportion to deviations of frequency below 60 Hertz.”

Response

The SDT has revised Boundary Detail #3 for frequency assumptions to further clarity.

Comment

Change “Voltages in the boundaries assume RMS fundamental frequency phase-to-ground or phase-to-phase voltage” to instead state “Voltage boundaries assume *per unit* RMS fundamental frequency phase-to-ground or phase-to-phase voltage.”

Response

The SDT has made the suggested language edits regarding the per unit voltage.

Comment

“In the interest of developing completely clear, unambiguous, grammatically correct Requirements, R3 could be better stated as:

Each Generator Owner or Transmission Owner shall document each known regulatory or equipment limitation¹ that prevents an applicable generating resource(s) (unit) with generator frequency or voltage protection from meeting the protection setting criteria in Requirements R1 or R2. Documentation includes (but is not limited to) study results, experience from an actual event, or manufacturer’s advice

The comment above can also be applied to R4. R4 is not very clear and may be providing an opportunity for entities to manipulate information to avoid complying. Recommend rewriting to clear up when and what processes allow for deviation from transmitting the setting information.”

Response

The SDT reviewed the proposed grammatical changes and has chosen to retain the current language.

Comment

Many commenters requested clarifying changes to the Facilities Section. Specifically, Facilities 4.2.1 includes “Frequency, voltage or volts per hertz protection including frequency or voltage protective functions within control systems”. This specifically calls out volts per hertz protection, but then assumes the reader will understand that the exciter volts per hertz protective function (tripping) is a voltage protective function. Would it be better to specifically mention the volts per hertz protective function within control systems?

Facilities 4.2.1 states “...that provide tripping or momentary cessation signals to all or part of the generating resource”. Currently only 4.2.1.1 is identified as being a generating resource. Should the statement be modified to include all or part of the dispersed power producing resources?

Facilities 4.2.1.5 makes reference to “the dispersed power producing resources”. Is it clear that this is referring to the dispersed power producing resources of Facilities 4.2.1.4? Would it be better to provide a complete description of the applicable dispersed power producing resources in 4.2.1.5?

In Attachment 2, Evaluating Protection Settings, item 1. d. includes the assumption “The automatic voltage regulator is in automatic voltage control mode”. If calculations are on the static case for steady state initial conditions, how does the automatic voltage regulator control mode come into play? Should item 1. d. be removed from the document?

Please modify Attachment 2, Evaluation Protection Settings, number 1. c. as follows, because there is no realistic scenario where the high side voltage will be 1.1 pu or higher and the generator voltage will be at 0.95 pf lagging. It is most realistic to use lagging pf for low voltage conditions and leading pf for high voltage conditions.

For low voltage protection use Power factor is 0.95 lagging (i.e. supplying reactive power to the system) as measured at the generator terminals. For high voltage settings use Power factor is 0.95 leading (i.e. taking reactive power from the system) as measured at the generator terminals.

Proposed requirement R4: In keeping with the intent of the current Standards Efficiency Review Project, R4 is not required within the proposed Standard as the capturing of data is redundant. The NSRF believes this can be captured under currently enforceable MOD-032-1, R2 which requests data developed by the PC and TP in R1.

Per the webinar, the SDT stated that Facilities 4.2.1.5 “Elements utilized in aggregation of the dispersed power producing resources” reads the same as PRC-025-2. The NSRF disagrees with this statement. This SDT is now expanding both PRC-025-2 and proposed PRC-024-3 to include items that make up the “collector systems”, which is directly against the FERC Approved definition of Inclusion I4. When the SDT states 4.2.1.5 is directly related to PRC-025-2 and has the same intentions, the NSRF strongly disagrees. When applying the FERC approved definition of Inclusion I4 and 4.2.1.5 of PRC-024-3 (or PRC-025-2) collector system items ARE NOT applicable to either Standard.

Response

The SDT has re-written the Facilities section to clarify the protection as well as on which equipment the protection applies; this includes moving, to the Facilities section, protection on equipment that was previously referenced in footnotes to PRC-024-2 requirements. The SDT's intent is that generating resource(s) (per BES Definition, 12/14) includes the generator terminal through the high side of the GSU/MPT. The Facilities Section of PRC-024-3 is consistent with footnotes #2 and #4 from PRC-024-2; the SDT has not changed the scope of the applicable facilities. The SDT has also modified Attachment 2, Evaluating Protection Settings to allow the use of most probable loading condition. The Standards Efficiency Review Phase 2 Team is tasked with addressing any additional requirements that may be redundant.

Comment

Footnote 5 : "Excludes limitations that are caused by the setting capability of the generator frequency and voltage protection relays themselves but does not exclude limitations originating in the equipment that they protect"

An older generator uses an electromechanical auxiliary relay for undervoltage protection. It is original equipment installed with the facility more than 30 years ago. There are no settings available on this relay. Similar to other auxiliary relays, when voltage dips below the drop out voltage, contacts would latch and trip the unit. The dropout characteristic of his relay does not meet PRC-024.

Would this case be considered an equipment limitation for PRC-024? We believe it does as it is original equipment with the plant and there is no language in the existing standard stating that new equipment needs to be installed. When new equipment is required (e.g. PRC-002 and PRC-025), a longer implementation period is accounted for.

Response

The SDT is not proposing substantive revisions to the PRC-024-2 language cited by the commenter. Questions regarding compliance with currently effective PRC-024-2 should be directed to ERO compliance staff.

Comment

Reclamation requests clarification of the rationale in allowing the Transmission Planner to make less stringent voltage settings than those required by Attachment 2.

Response

That rationale was determined by the drafting team for version 1 of PRC-024. Please see NERC's petition to FERC for approval of PRC-024-1, Exhibit E. This drafting team has made no changes to the standard regarding this matter.

Summary

Some commenters asserted that the issues being addressed in PRC-024-3 were taken care of by the NERC Alert and IRPTF and, therefore, PRC-024-2 does not need to be modified.

Response

The Standards Committee accepted the SARs to modify PRC-024-2, and the SDT is bound by the scope as outlined in the SAR.

Comment

Section 4.2.1.5 as currently proposed is sufficiently broad to potentially include rooftop solar and other similar distribution systems resources. Exelon suggests the more narrow statement based on BES Definition I4 to avoid confusion.

Response

The SDT has clarified Section 4.2.1.5 by referencing the BES Definition, I4

Comment

Regarding embedded frequency protection, it is not clear if generator speed signals that result in the trip of a unit are included. TAL believes this question should be addressed in the standard given that speed is directly related to frequency.

Response

Although it is possible to derive the mechanical rotational speed of the turbine/generator with an AC waveform from the generator bus instrument potential transformer, turbine/generator mechanical over/under speed protection is not in the scope of PRC-024-3 from a BES reliability perspective. The primary protection for turbine overspeed resides in the turbine controls and is extremely secure.

Comment

The elimination of footnote 1 implies that GOs are required to activate frequency and voltage protective relaying or protection systems where they currently may not be doing so. The footnote made it clear that the standard did not require these elements to be installed or activated on the generating unit. Another commenter asked about the associated documents and whether they are necessary.

Response

Footnote 1 has been reinstated in draft 2 of PRC-024-3. The SDT reviewed the associated documents and has determined that the references are not necessary; as such, they have been removed from the standard.

Comment

Texas RE requests clarification on Footnote 5 question regarding equipment limitations for wind turbines: do wind turbines equipment limitations include “smart crowbar” equipment limitations, UPS for the turbine control system, and tower vibration limits?

Response

Compliance determinations are facts-specific and should be reviewed on a case by case basis.

Comment

Including the phrase “experience from an actual event” as allowable evidence in Measure M3 for a regulatory or equipment limitation could imply that the limitation could occur during the event. The intent of the standards is that limitations shall be documented prior to an event occurring.

Response

The SDT discussed this matter and contends that the intent of the Measure and the Requirement is clear. No changes made.

Comment

Regarding VSLs - Although the wording is clear, this reviewer is uncertain how the Severe VSL for R3 can be enforced: "...failed to document any known non-protection system equipment limitation..." There would have to be documentation to demonstrate that the entity knows about the limitation.

Response

The SDT asserts that the Requirement R3 Severe VSL reflects the requirement language and is effective as written. For example, the Severe VSL could come into consideration for determining a penalty in the following scenario: During a compliance engagement, it is determined that an entity should have followed Requirement R1 for a particular setting. The entity verbally responds that it did not violate Requirement R1 because it relied on an equipment limitation. This reply indicates the entity knew about the limitation but this knowledge was indicated verbally. In this scenario, the entity was mentioning the knowledge of the equipment limitation to show that the entity did not need to comply with Requirement R1 for that setting. If it was determined that the entity did not violate Requirement R1 but did violate Requirement R3 because the entity did not document the known equipment limitation, then the Requirement R3 Severe VSL could be considered in the penalty calculation.

Comment

The Facilities section can be consolidated. There are currently redundancies in section 4.2.1. The following Facilities can be struck:

4.2.1.2 BES GSU transformer(s). This is part of the BES Generating resource so it is captured in 4.2.1.1.

4.2.1.4. Individual dispersed power producing resources identified in the BES Definition, Inclusion I4. This is a BES generating resource so it is captured in 4.2.1.1.

4.2.1.6 Collector transformer of resources identified in the BES Definition, Inclusion I4. This is part of the BES generating resource in Inclusion I4, so for the same reasons as striking, 4.2.1.2 and 4.2.1.4., it is captured in 4.2.1.1

We suggest that the Facilities section could be simplified. We do not believe that it is necessary to include the BES applicability language within the standard, since the standard should only be applicable to the BES.

Response

The BES definition includes equipment that would not be considered applicable under PRC-024-3. Therefore, to be clear, the exact equipment under the scope of PRC-024-3 has been intentionally called out in this manner.

Summary

Several commenters stated that there is a potential conflict between PRC-024 and PRC-006-NPCC-1

Response

Revising the regional standard is beyond the scope of this project. NERC will ensure the appropriate entities are made aware of the possible conflict so that any required changes to the regional standard may be pursued through the regional standard development process.

Comment

It is unclear whether the Evaluating Protection Settings section on page 21 of the redline proposed Standard

constitutes one or more requirements in connection with the evaluation of voltage protection settings. Are these additional compliance requirements that should therefore be referred to in or made a part of the main body of the proposed Standard? Is a study being required in connection with Requirement R2? If so, the SDT should incorporate a specific requirement in the proposed standard in order to eliminate confusion and ambiguity. The specific requirement should articulate (1) Responsible Entities shall perform a study and (2) the mandatory components of the study.

Response

The SDT has modified Evaluating Protection Settings and Requirement R2 for clarity.

Summary

Several commenters stated that the term “generating resources” should not be used and suggested using the term “generator” or “generating Facility”

Response

"Generating resource" is terminology consistently used in the BES Definition.

Summary

Several commenters stated that the equipment limitation exception to Requirements R1 and R2 that is contained in Requirement R3 is too broad and can be misapplied. We suggest adding an implementation period to allow all facilities to meet the protection setting criteria.

Response

There has been no change from the currently enforceable version of the standard. NERC writes standards to ensure reliable operation of the BES, and the SDT asserts that if these situations exist, they would be rare and would not pose an impact to the BES.

Standard Authorization Request (SAR)

Complete and please email this form, with attachment(s) to: sarcomm@nerc.net

The North American Electric Reliability Corporation (NERC) welcomes suggestions to improve the reliability of the bulk power system through improved Reliability Standards.

Requested information	
SAR Title:	Supplemental SAR for Project 2018-04 Modifications to PRC-024-2
Date Submitted:	6/14/2019
SAR Requester	
Name:	Jason Espinosa
Organization:	Seminole Electric Cooperative, Inc.
Telephone:	321-604-8619
Email:	jespinosa@seminole-electric.com
SAR Type (Check as many as apply)	
<input type="checkbox"/> New Standard <input checked="" type="checkbox"/> Revision to Existing Standard <input type="checkbox"/> Add, Modify or Retire a Glossary Term <input type="checkbox"/> Withdraw/retire an Existing Standard	<input type="checkbox"/> Imminent Action/ Confidential Issue (SPM Section 10) <input type="checkbox"/> Variance development or revision <input type="checkbox"/> Other (Please specify)
Justification for this proposed standard development project (Check all that apply to help NERC prioritize development)	
<input type="checkbox"/> Regulatory Initiation <input type="checkbox"/> Emerging Risk (Reliability Issues Steering Committee) Identified <input type="checkbox"/> Reliability Standard Development Plan	<input type="checkbox"/> NERC Standing Committee Identified <input type="checkbox"/> Enhanced Periodic Review Initiated <input checked="" type="checkbox"/> Industry Stakeholder Identified
Industry Need (What Bulk Electric System (BES) reliability benefit does the proposed project provide?):	
<p>During its discussions, the SDT identified two issues within PRC-024 that must be addressed to ensure the reliability intent of the standard is achieved.</p> <ol style="list-style-type: none"> In the currently enforceable standard, Requirements R1 and R2 refer only to "generator protective relaying" which seems to exclude the setting of voltage and frequency protection relays on the Generator Step-Up Transformer (GSU) associated with synchronous generators. Because the GSU and the generator are connected to the same bus and have the same source (the generator), they see the same voltage (and frequency). Consequently, the voltage and frequency protection settings applied to the relays on the GSU must be included in the standard as the operation of those relays would result in tripping the generator. Note: This situation does not exist in the standard for dispersed power producing resources because the associated collector transformer and its voltage and frequency protection is included via Inclusion I4 of the BES definition and in the standard through footnotes 2, 3, and 4. 	

Requested information

- 2. The existing standard is applicable only to Generator Owners which excludes instances where the Transmission Owner is the Registered Entity that owns the GSU or collector transformer and the associated voltage and frequency protective relays.

The Supplemental SAR expands the scope of the project to eliminate the identified reliability issues by: (1) requiring all voltage and frequency protection up to the point of interconnection (the high voltage side of the GSU or collector transformer) to adhere to the voltage and frequency boundary curves of PRC-024, and (2) requiring those Transmission Owners that own the GSU or collector transformer and the associated voltage and frequency protective relays to be compliant with the standard.

Closing these gaps increases reliability by ensuring all of the Registered Entities and facilities relevant to achieving the reliability intent of this standard are included in the Applicability Section and requirement language of the revised standard.

Purpose or Goal (How does this proposed project provide the reliability-related benefit described above?):

Ensure the voltage and frequency protection on all applicable equipment (including the GSU or collector transformer) up to the point of interconnection that could cause a generating resource to trip or cease to inject current meets the voltage and frequency ride-through requirements of PRC-024, thus enabling the generating resource to support grid stability during defined system voltage and frequency excursions.

Project Scope (Define the parameters of the proposed project):

Revise the Applicability to include all relevant Registered Entities and facilities to make the standard more comprehensive, and revise the requirement language to improve the clarity and completeness of the standard.

Requested information

Detailed Description (Describe the proposed deliverable(s) with sufficient detail for a drafting team to execute the project. If you propose a new or substantially revised Reliability Standard or definition, provide: (1) a technical justification¹ which includes a discussion of the reliability-related benefits of developing a new or revised Reliability Standard or definition, and (2) a technical foundation document (e.g. research paper) to guide development of the Standard or definition):

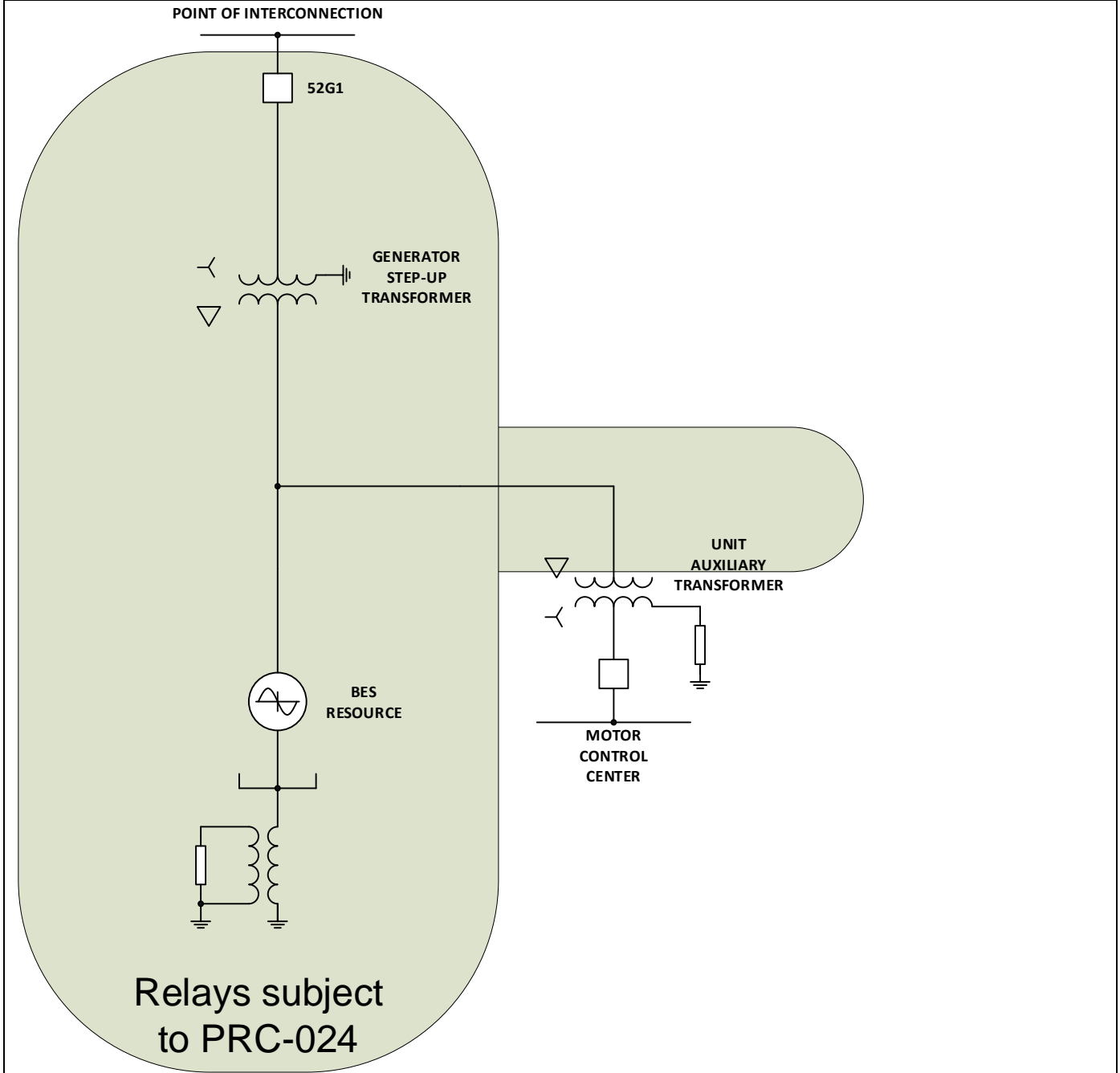

¹ The NERC Rules of Procedure require a technical justification for new or substantially revised Reliability Standards. Please attach pertinent information to this form before submittal to NERC.

Requested information

Referring to the figure above, all voltage and frequency protection relays in the shaded area would not be considered "generator protective relaying" and would therefore not be subject to the existing PRC-024-2 standard. However, the operation of any of these voltage and frequency protections results in the disconnection of the generating resource. If these relays are getting their voltage and frequency inputs from the terminals of the generator, then they are seeing the same voltage and frequency as the "generator protective relaying". Because the generator, GSU, and Unit Auxiliary Transformer (UAT) all see the same voltage and frequency since they are connected to the same bus (the generator being the source), the settings applied to the voltage and frequency protection on the GSU and the high side of the UAT must also comply with the PRC-024 frequency and voltage curves to ensure the generator remains connected during defined frequency and voltage excursions.

To avoid having to comply with PRC-024, an entity could remove (disable) the voltage and frequency protective functionality from the "generator protective relaying" and place it (enable) in either the GSU or UAT protection. Alternatively, an entity could enable voltage protective functions in both the "generator protective relaying" and the GSU relaying. If the generator voltage protective function is set outside of the no trip zone and the GSU relay voltage protective function is set within the no trip zone; then for a voltage excursion condition (within the no trip zone), the generator protection would not initiate a trip but the GSU relay would initiate a trip. This would not qualify as a violation of PRC-024 according to the existing language but it would conflict with the intent of the standard since the generation would be taken off-line without the generator protection initiating the trip.

The SDT asserts that all frequency and voltage protective functions from the generator up to the point of interconnection should have to comply with the requirements of PRC-024. This would ensure the reliability intent of the standard is achieved, enabling the generator to ride through defined frequency and voltage excursions at the point of interconnection.

Cost Impact Assessment, if known (Provide a paragraph describing the potential cost impacts associated with the proposed project):

Please describe any unique characteristics of the BES facilities that may be impacted by this proposed standard development project (e.g. Dispersed Generation Resources):

Frequency and voltage protective functions on GSUs/collector transformers owned by transmission entities, synchronous generation, and inverter-based resources may be impacted by the revisions.

To assist the NERC Standards Committee in appointing a drafting team with the appropriate members, please indicate to which Functional Entities the proposed standard(s) should apply (e.g. Transmission Operator, Reliability Coordinator, etc. See the most recent version of the NERC Functional Model for definitions):

All Generator Owners and only those Transmission Owners that own a GSU or collector transformer and associated voltage and frequency protection.

Do you know of any consensus building activities ² in connection with this SAR? If so, please provide any recommendations or findings resulting from the consensus building activity.
Project 2018-04 Modifications to PRC-024-2
Are there any related standards or SARs that should be assessed for impact as a result of this proposed project? If so which standard(s) or project number(s)?
No
Are there alternatives (e.g. guidelines, white paper, alerts, etc.) that have been considered or could meet the objectives? If so, please list the alternatives.
No

Reliability Principles	
Does this proposed standard development project support at least one of the following Reliability Principles (Reliability Interface Principles)? Please check all those that apply.	
<input checked="" type="checkbox"/>	1. Interconnected bulk power systems shall be planned and operated in a coordinated manner to perform reliably under normal and abnormal conditions as defined in the NERC Standards.
<input checked="" type="checkbox"/>	2. The frequency and voltage of interconnected bulk power systems shall be controlled within defined limits through the balancing of real and reactive power supply and demand.
<input type="checkbox"/>	3. Information necessary for the planning and operation of interconnected bulk power systems shall be made available to those entities responsible for planning and operating the systems reliably.
<input type="checkbox"/>	4. Plans for emergency operation and system restoration of interconnected bulk power systems shall be developed, coordinated, maintained and implemented.
<input type="checkbox"/>	5. Facilities for communication, monitoring and control shall be provided, used and maintained for the reliability of interconnected bulk power systems.
<input type="checkbox"/>	6. Personnel responsible for planning and operating interconnected bulk power systems shall be trained, qualified, and have the responsibility and authority to implement actions.
<input type="checkbox"/>	7. The security of the interconnected bulk power systems shall be assessed, monitored and maintained on a wide area basis.
<input type="checkbox"/>	8. Bulk power systems shall be protected from malicious physical or cyber attacks.

Market Interface Principles	
Does the proposed standard development project comply with all of the following Market Interface Principles ?	Enter (yes/no)
1. A reliability standard shall not give any market participant an unfair competitive advantage.	Yes
2. A reliability standard shall neither mandate nor prohibit any specific market structure.	Yes
3. A reliability standard shall not preclude market solutions to achieving compliance with that standard.	Yes

² Consensus building activities are occasionally conducted by NERC and/or project review teams. They typically are conducted to obtain industry inputs prior to proposing any standard development project to revise, or develop a standard or definition.

Market Interface Principles	
4. A reliability standard shall not require the public disclosure of commercially sensitive information. All market participants shall have equal opportunity to access commercially non-sensitive information that is required for compliance with reliability standards.	Yes

Identified Existing or Potential Regional or Interconnection Variances	
Region(s)/ Interconnection	Explanation
None	None

For Use by NERC Only

SAR Status Tracking (Check off as appropriate)	
<input type="checkbox"/> Draft SAR reviewed by NERC Staff	<input type="checkbox"/> Final SAR endorsed by the SC
<input type="checkbox"/> Draft SAR presented to SC for acceptance	<input type="checkbox"/> SAR assigned a Standards Project by NERC
<input type="checkbox"/> DRAFT SAR approved for posting by the SC	<input type="checkbox"/> SAR denied or proposed as Guidance document

Version History

Version	Date	Owner	Change Tracking
1	June 3, 2013		Revised
1	August 29, 2014	Standards Information Staff	Updated template
2	January 18, 2017	Standards Information Staff	Revised
2	June 28, 2017	Standards Information Staff	Updated template

Unofficial Comment Form

Project 2018-04 Modifications to PRC-024-2

Do not use this form for submitting comments. Use the [Standards Balloting and Commenting System \(SBS\)](#) to submit comments on the **Project 2018-04 Modifications to PRC-024-2 Supplemental Standard Authorization Request (SAR)**. Comments must be submitted by **8 p.m. Eastern, Friday, July 26, 2019**.

Additional information is available on the [project page](#). If you have questions, contact Standards Developer, [Mat Bunch](#) (via email) or at (404) 446-9785.

Background Information

On November 27, 2018, the NERC Operating Committee (OC) and Planning Committee (PC) submitted a SAR prepared by the Inverter-Based Resource Performance Task Force (IRPTF), which reports to the OC and PC. Based off the disturbance analyses and development of the [PRC-024-2 Gaps Whitepaper](#), the IRPTF identified potential modifications to PRC-024-2 to help ensure inverter-based generator owners, operators, developers, and equipment manufacturers understand the intent of the standard for their plants to respond to grid disturbances to contribute to the reliable operation of the Bulk Power System. The initial [SAR](#) proposed to revise PRC-024-2 to address those identified issues regarding inverter-based resources and to address ambiguities, inconsistencies, and technical errors within the existing standard. The SAR was posted from December 19, 2018 – January 18, 2019, and during that posting, NERC solicited volunteers to serve on the project drafting team. The Standards Committee accepted the SAR and appointed the drafting team on February 20, 2019.

During its discussions, the standard drafting team (SDT) identified two issues within PRC-024 that must be addressed to ensure the reliability intent of the standard is achieved.

1. The existing standard refers only to "generator protective relaying" which seems to exclude the setting of voltage and frequency protection relays on the Generator Step-Up Transformer (GSU) associated with synchronous generators. Because the GSU and the generator are connected to the same bus and have the same source (the generator), they see the same voltage (and frequency). Consequently, the voltage and frequency protection settings applied to the relays on the GSU must be included in the standard as the operation of those relays would result in tripping the generator, thus defeating the reliability intent of the standard. Note: This situation does not exist for dispersed power producing resources because the associated collector transformer is included via Inclusion I4 of the BES definition and in the standard through footnotes 2, 3, and 4. The Supplemental SAR expands the scope of the project to include the setting of voltage and frequency protective relays (if applied) on GSUs.
2. The existing standard is applicable only to Generator Owners which excludes instances where the Transmission Owner is the Registered Entity that owns the GSU or collector transformer and the associated voltage and frequency protective relays. This exclusion defeats the reliability intent of the standard.

The Supplemental SAR expands the scope of the project to allow the inclusion of Transmission Owners that own the GSU or collector transformer with the applicable voltage and frequency protection activated.

Because of the change to the Applicability Section of the standard, NERC staff will provide notice to stakeholders that the ballot pool for Project 2018-04 Modifications to PRC-024-2 (page linked above) will be reopened for the first 30 days of the next comment and ballot period so that anyone not currently in the ballot pool can join.

Questions

1. Do you agree with the scope of the Supplemental SAR to include the setting of voltage and frequency protective relays (if applied) on GSUs or collector transformers? If you do not agree, or if you agree but have comments or suggestions, provide your recommendation or proposed modification below.

- Yes
 No

Comments:

2. Are you aware of any organizations registered as a Transmission Owner (but not registered as Generator Owner) that own a GSU or collector transformer and apply the applicable protection listed above? If so, please provide an example and any relevant technical information.

- Yes
 No

Comments:

3. If you have any other comments on this SAR that you haven't already mentioned above, provide them here.

- Yes
 No

Standards Announcement

Project 2018-04 Modifications to PRC-024-2

Informal Comment Period Open through July 26, 2019

[Now Available](#)

An informal comment period for the **Project 2018-04 Modifications to PRC-024-2 Supplemental Standard Authorization Request** is open through **8 p.m. Eastern, Friday, July 26, 2019**.

Commenting

Use the [Standards Balloting and Commenting System \(SBS\)](#) to submit comments. If you experience issues using the SBS, contact [Wendy Muller](#). An unofficial Word version of the comment form is posted on the [project page](#).

- *If you are having difficulty accessing the SBS due to a forgotten password, incorrect credential error messages, or system lock-out, contact NERC IT support directly at <https://support.nerc.net/> (Monday – Friday, 8 a.m. - 5 p.m. Eastern).*
- *Passwords expire every **6 months** and must be reset.*
- *The SBS **is not** supported for use on mobile devices.*
- *Please be mindful of ballot and comment period closing dates. We ask to **allow at least 48 hours** for NERC support staff to assist with inquiries. Therefore, it is recommended that users try logging into their SBS accounts **prior to the last day**.*

Next Steps

The drafting team will review all responses received during the comment period and determine the next steps of the project.

For information on the Standards Development Process, refer to the [Standard Processes Manual](#).

For more information or assistance, contact Standards Developer, [Mat Bunch](#) (via email) or at (404) 446-9785.

North American Electric Reliability Corporation
3353 Peachtree Rd, NE
Suite 600, North Tower
Atlanta, GA 30326
404-446-2560 | www.nerc.com

Comment Report

Project Name: 2018-04 Modifications to PRC-024-2 | Supplemental SAR
Comment Period Start Date: 6/27/2019
Comment Period End Date: 7/26/2019
Associated Ballots:

There were 39 sets of responses, including comments from approximately 97 different people from approximately 77 companies representing 10 of the Industry Segments as shown in the table on the following pages.

Questions

1. Do you agree with the scope of the Supplemental SAR to include the setting of voltage and frequency protective relays (if applied) on GSUs or collector transformers? If you do not agree, or if you agree but have comments or suggestions, provide your recommendation or proposed modification below.

2. Are you aware of any organizations registered as a Transmission Owner (but not registered as Generator Owner) that own a GGU or collector transformer and apply the applicable protection listed above? If so, please provide an example and any relevant technical information.

3. If you have any other comments on this SAR that you haven't already mentioned above, provide them here

Organization Name	Name	Segment(s)	Region	Group Name	Group Member Name	Group Member Organization	Group Member Segment(s)	Group Member Region
Southwest Power Pool, Inc. (RTO)	Charles Yeung	2	SPP RE	SRC	Helen Lainis	IESO	2	NPCC
					Greg Campoli	NYISO	2	NPCC
					Dave Zwergel	MISO	2	MRO
					Mark Holman	PJM	2	RF
					Matt Goldberg	ISONE	1	NPCC
					Ali Miremadi	CAISO	1	WECC
					Nathan Bigbee	ERCOT	1	Texas RE
Great Plains Energy - Kansas City Power and Light Co.	Douglas Webb	1,3,5,6	MRO,SPP RE	Westar-KCPL	Doug Webb	Westar	1,3,5,6	MRO
					Doug Webb	KCP&L	1,3,5,6	MRO
ACES Power Marketing	Jodirah Green	1,3,4,5,6	MRO,NA - Not Applicable,RF,SERC,Texas RE,WECC	ACES Standard Collaborations	Bob Solomon	Hoosier Energy Rural Electric Cooperative, Inc.	1	SERC
					Kevin Lyons	Central Iowa Power Cooperative	1	MRO
					Jennifer Bray	Arizona Electric Power Cooperative	1	WECC
					Bill Hutchison	Southern Illinois Power Cooperative	1	SERC
					Shari Heino	Brazos Electric Power Cooperative, Inc.	5	Texas RE
Southern Company - Alabama Power Company	Joel Dembowski	3		Southern Company	Adrienne Collins	Southern Company Services, Inc.	1	SERC
					Bill Shultz	Southern Company Generation	5	SERC

					Ron Carlsen	Southern Company Generation and Energy Marketing	6	SERC
					Joel Dembowski	Alabama Power Company	3	SERC
DTE Energy - Detroit Edison Company	Karie Barczak	3,4,5		DTE Energy - DTE Electric	Jeffrey Depriest	DTE Energy - DTE Electric	5	RF
					Daniel Herring	DTE Energy - DTE Electric	4	RF
					Karie Barczak	DTE Energy - DTE Electric	3	RF
Duke Energy	Katherine Street	1,3,5,6	FRCC,RF,SERC	Duke Energy	Laura Lee	Duke Energy	1	SERC
					Dale Goodwine	Duke Energy	5	SERC
					Greg Cecil	Duke Energy	6	RF
					Lee Schuster	Duke Energy	3	SERC
Northeast Power Coordinating Council	Ruida Shu	1,2,3,4,5,6,7,8,9,10	NPCC	RSC no Dominion and HQ	Guy V. Zito	Northeast Power Coordinating Council	10	NPCC
					Randy MacDonald	New Brunswick Power	2	NPCC
					Glen Smith	Entergy Services	4	NPCC
					Brian Robinson	Utility Services	5	NPCC
					Alan Adamson	New York State Reliability Council	7	NPCC
					David Burke	Orange & Rockland Utilities	3	NPCC
					Michele Tondalo	UI	1	NPCC
					Helen Lainis	IESO	2	NPCC
					Michael Jones	National Grid	3	NPCC
					Sean Cavote	PSEG	4	NPCC

Kathleen Goodman	ISO-NE	2	NPCC
David Kiguel	Independent	NA - Not Applicable	NPCC
Silvia Mitchell	NextEra Energy - Florida Power and Light Co.	6	NPCC
Paul Malozewski	Hydro One Networks, Inc.	3	NPCC
Gregory Campoli	New York Independent System Operator	2	NPCC
Laura McLeod	NB Power Corporation	5	NPCC
Nick Kowalczyk	Orange and Rockland	1	NPCC
John Hastings	National Grid	1	NPCC
Joel Charlebois	AESI - Acumen Engineered Solutions International Inc.	5	NPCC
Quintin Lee	Eversource Energy	1	NPCC
Mike Cooke	Ontario Power Generation, Inc.	4	NPCC
Salvatore Spagnolo	New York Power Authority	1	NPCC
Shivaz Chopra	New York Power Authority	5	NPCC
Mike Forte	Con Ed - Consolidated Edison	4	NPCC
Dermot Smyth	Con Ed - Consolidated Edison Co. of New York	1	NPCC

					Peter Yost	Con Ed - Consolidated Edison Co. of New York	3	NPCC
					Ashmeet Kaur	Con Ed - Consolidated Edison	5	NPCC
Dominion - Dominion Resources, Inc.	Sean Bodkin	3,5,6		Dominion	Connie Lowe	Dominion - Dominion Resources, Inc.	3	NA - Not Applicable
					Lou Oberski	Dominion - Dominion Resources, Inc.	5	NA - Not Applicable
					Larry Nash	Dominion - Dominion Virginia Power	1	NA - Not Applicable
Lower Colorado River Authority	Teresa Cantwell	1,5		LCRA Compliance	Michael Shaw	LCRA	6	Texas RE
					Dixie Wells	LCRA	5	Texas RE
					Teresa Cantwell	LCRA	1	Texas RE

1. Do you agree with the scope of the Supplemental SAR to include the setting of voltage and frequency protective relays (if applied) on GSUs or collector transformers? If you do not agree, or if you agree but have comments or suggestions, provide your recommendation or proposed modification below.

Thomas Foltz - AEP - 3,5

Answer No

Document Name

Comment

AEP has no objections to altering the scope and direction of this project as proposed in the most recent SAR, however we do object to the manner in which it is being pursued. It appears that this "supplemental SAR" would be applied to Project 2018-04 along with the existing SAR, bringing the total number of SARs for this project to two. AEP is not aware of any precedent of multiple, concurrent SARs governing a NERC project at a single point in time. A SAR helps set a project's direction and scope, and while a project's SAR may be revised over time, AEP does not believe Appendix 3A of the Standards Process Manual provides an allowance for multiple, concurrent SARs to govern a single NERC project. Rather, the SPM allows a project's existing SAR to be revised to accommodate any changes believed to be necessary. If this project's scope or direction needs to be revised, the current and governing SAR should be revised accordingly rather than developing an additional SAR to somehow expand upon its predecessor.

Likes 0

Dislikes 0

Response

Allen Schriver - NextEra Energy - 5

Answer No

Document Name

Comment

The Supplemental SAR is attempting to expand the scope of the PRC-024 changes beyond the intent of providing clarity for inverter response.

Likes 0

Dislikes 0

Response

Michelle Amarantos - APS - Arizona Public Service Co. - 1,3,5,6

Answer No

Document Name

Comment

AZPS suggests generator side terminal voltage be used instead of the high-side voltage. Using high-side GSU voltage unnecessarily creates confusion and calculation burden, when there has been no realistic case study or other justification presented that would support using the terminal voltage or that indicates that use of the generator side terminal voltage will not be adequate. In fact, due to AVR, AZPS respectfully asserts that use of the generator terminal voltage is steadier and more appropriate than use of the high-side voltage. AZPS suggests generator side terminal voltage be used instead of the high-side voltage. Using high-side GSU voltage unnecessarily creates confusion and calculation burden, when there has been no realistic case study or other justification presented that would support using the terminal voltage or that indicates that use of the generator side terminal voltage will not be adequate. In fact, due to AVR, AZPS respectfully asserts that use of the generator terminal voltage is steadier and more appropriate than use of the high-side voltage.

Likes 0

Dislikes 0

Response

Mark Gray - Edison Electric Institute - NA - Not Applicable - NA - Not Applicable

Answer

No

Document Name

Comment

EI Member companies do not support the proposed Supplemental SAR because it does not provide a technical justification that describes a reliability gap that needs to be addressed. The Supplemental SAR also does not provide a technical basis for adding new obligations to Transmission Owners (TOs) who may own Generator Step-up (GSUs) and collector transformers.

Likes 0

Dislikes 0

Response

Douglas Webb - Great Plains Energy - Kansas City Power and Light Co. - 1,3,5,6 - MRO, Group Name Westar-KCPL

Answer

No

Document Name

Comment

Westar Energy and Kansas City Power & Light Company endorse the Edison Electric Institute's response to Question 1.

Likes 0

Dislikes 0

Response

Joel Dembowski - Southern Company - Alabama Power Company - 3, Group Name Southern Company

Answer	No
Document Name	
Comment	
The protection elements on main station transformers have not been reported to have been nor are known to have been the cause of plant tripping due to transmission system voltage or frequency disturbances. No established need exists relative to system reliability improvement. The scope expansion is not needed. The SAR fails to clearly and sufficiently identify a gap in BES reliability.	
Likes 0	
Dislikes 0	
Response	
Armin Klusman - CenterPoint Energy Houston Electric, LLC - 1 - Texas RE	
Answer	No
Document Name	
Comment	
CenterPoint Energy Houston Electric, LLC agrees with the comments submitted on behalf of The Edison Electrical Institute.	
Likes 0	
Dislikes 0	
Response	
Sean Bodkin - Dominion - Dominion Resources, Inc. - 3,5,6, Group Name Dominion	
Answer	No
Document Name	
Comment	
Dominion Energy does not agree that a reliability gap was identified in the proposed SAR. The original scope of the SAR is appropriate to address the identified and substantiated issue related to inverters during system events. The equipment mentioned in the SAR (GSUs and collector transformers) have never been part of PRC-024. The mention in a foot note of this equipment is ONLY in reference to defining point of interconnection within the standard and inclusion 4 of the BES definition does not include or even mentions these pieces of equipment. The scope of the project should NOT be expanded to an issue that has not been substantiated and reliability risk identified.	
Likes 0	
Dislikes 0	
Response	

Katherine Street - Duke Energy - 1,3,5,6 - SERC,RF, Group Name Duke Energy

Answer Yes

Document Name

Comment

As the terms 'GSU' and 'collector transformer' appear to be used inconsistently across the industry--clarification within the Reliability Standard or definitions may be necessary to achieve consistency.

Likes 0

Dislikes 0

Response

Leonard Kula - Independent Electricity System Operator - 2

Answer Yes

Document Name

Comment

We agree with including the setting of voltage and frequency protective relays (if applied) on GSUs or collector transformers, however, there still remains a reliability gap in the scope. The scope should also include auxiliaries critical to maintain plant output. The supply to other critical auxiliaries like lubricating systems, governing and excitation systems that allow the generating unit to maintain its output level must also meet PRC-024 requirements for reliability.

Having auxiliaries trip too early on voltage or frequency which cause output to change is by definition an interaction between the plant and the power system. The diagram in the Supplemental SAR should be amended to show the Motor Control Center (MCC) handling a critical load be subject to PRC-024 (within the shaded area), as the operation of this would result in tripping and defeat the reliability intent of the standard. The diagram can also show a non-critical load handled by the MCC not subject to the PRC-024 (outside the shaded area) to highlight that if the tripping auxiliary does not affect that would be P,Q, or Vt of the units, then they do not need to be included.

Likes 0

Dislikes 0

Response

David Jendras - Ameren - Ameren Services - 1,3,6

Answer Yes

Document Name

Comment

Ameren agrees with revising the Applicability to include all relevant Registered Entities and facilities to make the standard more comprehensive, and revise the requirement language to improve the clarity and completeness of the standard. Ameren supports this effort to ensure the voltage and frequency protection on all applicable equipment (including the GSU or collector transformer) up to the point of interconnection that could cause a generating resource to trip or cease to inject current meets the voltage and frequency ride-through requirements of PRC-024, thus enabling the generating resource to support grid stability during defined system voltage and frequency excursions.

Likes 0

Dislikes 0

Response

Chris Scanlon - Exelon - 1,3,5,6

Answer

Yes

Document Name

Comment

Exelon might agree to the scope of the SAR if the Standard Drafting Team provides sufficient technical basis. At this point in time, Exelon does not believe that sufficient technical basis has been provided to move forward with the supplemental SAR.

Likes 0

Dislikes 0

Response

John Bee - Exelon - 1,3,5,6

Answer

Yes

Document Name

Comment

Exelon might agree to the scope of the SAR if the Standard Drafting Team provides sufficient technical basis. At this point in time, Exelon does not believe that sufficient technical basis has been provided to move forward with the supplemental SAR.

Likes 0

Dislikes 0

Response

Ruth Miller - Exelon - 1,3,5,6

Answer

Yes

Document Name

Comment

Exelon might agree to the scope of the SAR if the Standard Drafting Team provides sufficient technical basis. At this point in time, Exelon does not believe that sufficient technical basis has been provided to move forward with the supplemental SAR.

Likes 0

Dislikes 0

Response**Becky Webb - Exelon - 1,3,5,6**

Answer

Yes

Document Name

Comment

Exelon might agree to the scope of the SAR if the Standard Drafting Team provides sufficient technical basis. At this point in time, Exelon does not believe that sufficient technical basis has been provided to move forward with the supplemental SAR.

Likes 0

Dislikes 0

Response**Richard Jackson - U.S. Bureau of Reclamation - 1,5**

Answer

Yes

Document Name

Comment

Reclamation supports the scope clarification of the Supplemental SAR and recommends the figure on page 3 of the Supplemental SAR be included in the Guidelines and Technical Basis of the revised standard.

Likes 0

Dislikes 0

Response**Michael Godbout - Hydro-Quebec TransEnergie - 1 - NPCC**

Answer

Yes

Document Name

Comment

We consider it important to subject the appropriate relays regardless of the owner. This approach is consistent with NERC's approach in other standards that require the applicability to facilities necessary to reliability, for example, FAC-008, PRC-005, PRC-025. These standards all apply to both TO and GO as function and specify the facilities subject to the standards, regardless of ownership, and there is no gap.

The extension of the applicability to the TO is justified on its technical merits and the impact to a TO without GSU would be, at worse, a bit of paperwork. If a Regional Entity were to audit a TO that does not own GSU for a version of PRC-024 that applies to TO that own GSU, which seems a bit senseless to us, the TO can fill in an RSAW easily, saying, "Not applicable because we do not own a GSU."

As a technical quibble, we note that the Supplemental SAR defines the "point of interconnection" as the high-side of the step-up transformer (with a parenthetical remark). We think that, like in FAC-008, the standard (and the supplemental SAR) need not introduce and use the POI term. It can just use the term "high-side of the step-up transformer" directly. That said, with the parenthetical remark and the graphic, it is quite clear what is intended in the supplemental SAR.

Likes 0

Dislikes 0

Response

Aaron Cavanaugh - Bonneville Power Administration - 1,3,5,6 - WECC

Answer

Yes

Document Name

Comment

None

Likes 0

Dislikes 0

Response

Bruce Reimer - Manitoba Hydro - 1,3,5,6

Answer

Yes

Document Name

Comment

V/Hz protective relay setting requirement for the GSUs or collector transformers should be added to the standard (V/Hz ride through curve).

Likes 0

Dislikes 0

Response

Charles Yeung - Southwest Power Pool, Inc. (RTO) - 2, Group Name SRC

Answer Yes

Document Name

Comment

The PRC-024 was developed at a time when generators and generator step-up transformers were more often than not owned by the same asset owner. As such coordination between generator protection schemes and associated transmission equipment may not have required any explicit requirements and the PRC-024 applicability to only the generator side of the interconnection was sufficient. Today, with the separation of ownership of assets at the generator point of interconnection, NERC must ensure the intent of PRC-024 is met through adding explicit requirements which may or may not fall within the original construct of the standard.

Likes 0

Dislikes 0

Response

Joshua Andersen - Salt River Project - 1,3,5,6 - WECC

Answer Yes

Document Name

Comment

SRP recommends the scope to only include phase over/under voltages that are enabled and not 3VO overvoltage like in the case of a zero sequence over voltage.

Likes 0

Dislikes 0

Response

Jodirah Green - ACES Power Marketing - 1,3,4,5,6 - MRO,WECC,Texas RE,SERC,RF, Group Name ACES Standard Collaborations

Answer Yes

Document Name

Comment

We would like to request that the drafting team provide industry the opportunity to address and clarify some of the concerns with the existing draft of the PRC-024-3 language at a later time.

Likes 0

Dislikes 0

Response

Constantin Chitescu - Ontario Power Generation Inc. - 5

Answer Yes

Document Name

Comment

OPG agrees with closing the reliability gap. Suggestion is made to consider the use of Main Output Transformers (MOT) instead of GSU.

Likes 0

Dislikes 0

Response

Matthew Nutsch - Seattle City Light - 1,3,4,5,6 - WECC

Answer Yes

Document Name

Comment

Likes 0

Dislikes 0

Response

Karie Barczak - DTE Energy - Detroit Edison Company - 3,4,5, Group Name DTE Energy - DTE Electric

Answer Yes

Document Name

Comment

Likes 0

Dislikes 0

Response

Bette White - AES - Indianapolis Power and Light Co. - 3

Answer	Yes
--------	-----

Document Name	
---------------	--

Comment	
---------	--

Likes	0
-------	---

Dislikes	0
----------	---

Response	
----------	--

Maryanne Darling-Reich - Black Hills Corporation - 1,3,5,6 - MRO,WECC

Answer	Yes
--------	-----

Document Name	
---------------	--

Comment	
---------	--

Likes	0
-------	---

Dislikes	0
----------	---

Response	
----------	--

faranak sarbaz - Los Angeles Department of Water and Power - 1,3,5,6

Answer	Yes
--------	-----

Document Name	
---------------	--

Comment	
---------	--

Likes	0
-------	---

Dislikes	0
----------	---

Response	
----------	--

Rachel Coyne - Texas Reliability Entity, Inc. - 10

Answer	Yes
--------	-----

Document Name	
---------------	--

Comment	
---------	--

Likes 0

Dislikes 0

Response

Anthony Jablonski - ReliabilityFirst - 10

Answer Yes

Document Name

Comment

Likes 0

Dislikes 0

Response

Sandra Kennedy - CMS Energy - Consumers Energy Company - 1,3,4,5 - RF

Answer Yes

Document Name

Comment

Likes 0

Dislikes 0

Response

Kjersti Drott - Tri-State G and T Association, Inc. - 1,3,5

Answer Yes

Document Name

Comment

Likes 0

Dislikes 0

Response

Jamie Monette - Allete - Minnesota Power, Inc. - 1

Answer	Yes
Document Name	
Comment	
Likes 0	
Dislikes 0	
Response	
Neil Swearingen - Salt River Project - 1,3,5,6 - WECC	
Answer	Yes
Document Name	
Comment	
Likes 0	
Dislikes 0	
Response	
Teresa Cantwell - Lower Colorado River Authority - 1,5, Group Name LCRA Compliance	
Answer	Yes
Document Name	
Comment	
Likes 0	
Dislikes 0	
Response	
Steven Rueckert - Western Electricity Coordinating Council - 10	
Answer	Yes
Document Name	
Comment	
Likes 0	

Dislikes 0

Response

Amy Casuscelli - Xcel Energy, Inc. - 1,3,5,6 - MRO,WECC

Answer

Yes

Document Name

Comment

Likes 0

Dislikes 0

Response

Richard Vine - California ISO - 2

Answer

Document Name

Comment

The California ISO supports the comments submitted by the ISO/RTO Council Standards Review Committee (SRC)

Likes 0

Dislikes 0

Response

2. Are you aware of any organizations registered as a Transmission Owner (but not registered as Generator Owner) that own a GSU or collector transformer and apply the applicable protection listed above? If so, please provide an example and any relevant technical information.

Sean Bodkin - Dominion - Dominion Resources, Inc. - 3,5,6, Group Name Dominion

Answer No

Document Name

Comment

Dominion Energy does not have any of these assets that are owned by our Transmission Owner registration (we are also separately registered as a GO). We are also unaware of any other entities in the United States that fit this criteria.

Likes 0

Dislikes 0

Response

Armin Klusman - CenterPoint Energy Houston Electric, LLC - 1 - Texas RE

Answer No

Document Name

Comment

CenterPoint Energy Houston Electric, LLC agrees with the comments submitted on behalf of The Edison Electrical Institute.

Likes 0

Dislikes 0

Response

Constantin Chitescu - Ontario Power Generation Inc. - 5

Answer No

Document Name

Comment

OPG is not aware of such cases.

Likes 0

Dislikes 0

Response

Joel Dembowski - Southern Company - Alabama Power Company - 3, Group Name Southern Company

Answer No

Document Name

Comment

The number of TO owned main generating station transformers is believed to be very few. In Southern Company, the number of TO owned generator step up transformers is zero.

Likes 0

Dislikes 0

Response

Douglas Webb - Great Plains Energy - Kansas City Power and Light Co. - 1,3,5,6 - MRO, Group Name Westar-KCPL

Answer No

Document Name

Comment

Westar Energy and Kansas City Power & Light Company incorporate by reference the Edison Electric Institute's response to Question 2.

Likes 0

Dislikes 0

Response

Teresa Cantwell - Lower Colorado River Authority - 1,5, Group Name LCRA Compliance

Answer No

Document Name

Comment

As an organization, LCRA is registered as both TO and GO.

Likes 0

Dislikes 0

Response

Charles Yeung - Southwest Power Pool, Inc. (RTO) - 2, Group Name SRC**Answer** No**Document Name****Comment**

We are aware there are entities that are concerned that including the generator step up transformer as part of a generator protection standard may be inappropriate because the original intent of PRC-024 is to apply to generator protection systems. However, the importance to coordinate the protection schemes for inverter based resources and the transmission grid cannot and should not be limited to what registered entity a standard is applicable to.

Likes 0

Dislikes 0

Response**Mark Gray - Edison Electric Institute - NA - Not Applicable - NA - Not Applicable****Answer** No**Document Name****Comment**

EI is not aware of any instances, among member companies, of the situation described in Question 2 that exists based on readily available information.

Likes 0

Dislikes 0

Response**Aaron Cavanaugh - Bonneville Power Administration - 1,3,5,6 - WECC****Answer** No**Document Name****Comment**

None

Likes 0

Dislikes 0

Response

Michelle Amarantos - APS - Arizona Public Service Co. - 1,3,5,6

Answer No

Document Name

Comment

While there may be instances of a Transmission Owner owning a GSU or collector transformer, these are more likely to be exceptional cases or anomalies, which do not justify modifying the applicability of the standard or adding additional burden to Transmission Owners to assess applicability.

Likes 0

Dislikes 0

Response

Becky Webb - Exelon - 1,3,5,6

Answer No

Document Name

Comment

Exelon supports EEI's comments that this question alone may be insufficient to gather the data needed to identify the magnitude of this issue because all relevant parties may not choose to respond.

Likes 0

Dislikes 0

Response

Ruth Miller - Exelon - 1,3,5,6

Answer No

Document Name

Comment

Exelon supports EEI's comments that this question alone may be insufficient to gather the data needed to identify the magnitude of this issue because all relevant parties may not choose to respond.

Likes 0

Dislikes 0

Response

John Bee - Exelon - 1,3,5,6**Answer** No**Document Name****Comment**

Exelon supports EEI's comments that this question alone may be insufficient to gather the data needed to identify the magnitude of this issue because all relevant parties may not choose to respond.

Likes 0

Dislikes 0

Response**Chris Scanlon - Exelon - 1,3,5,6****Answer** No**Document Name****Comment**

Exelon supports EEI's comments that this question alone may be insufficient to gather the data needed to identify the magnitude of this issue because all relevant parties may not choose to respond.

Likes 0

Dislikes 0

Response**Maryanne Darling-Reich - Black Hills Corporation - 1,3,5,6 - MRO,WECC****Answer** No**Document Name****Comment**

Not aware of others, not applicable to BHC

Likes 0

Dislikes 0

Response**Amy Casuscelli - Xcel Energy, Inc. - 1,3,5,6 - MRO,WECC**

Answer	No
Document Name	
Comment	
Likes 0	
Dislikes 0	
Response	
Steven Rueckert - Western Electricity Coordinating Council - 10	
Answer	No
Document Name	
Comment	
Likes 0	
Dislikes 0	
Response	
Jodirah Green - ACES Power Marketing - 1,3,4,5,6 - MRO,WECC,Texas RE,SERC,RF, Group Name ACES Standard Collaborations	
Answer	No
Document Name	
Comment	
Likes 0	
Dislikes 0	
Response	
Neil Swearingen - Salt River Project - 1,3,5,6 - WECC	
Answer	No
Document Name	
Comment	
Likes 0	

Dislikes 0

Response

Bruce Reimer - Manitoba Hydro - 1,3,5,6

Answer

No

Document Name

Comment

Likes 0

Dislikes 0

Response

Jamie Monette - Allete - Minnesota Power, Inc. - 1

Answer

No

Document Name

Comment

Likes 0

Dislikes 0

Response

Kjersti Drott - Tri-State G and T Association, Inc. - 1,3,5

Answer

No

Document Name

Comment

Likes 0

Dislikes 0

Response

Richard Jackson - U.S. Bureau of Reclamation - 1,5

Answer

No

Document Name	
Comment	
Likes 0	
Dislikes 0	
Response	
Sandra Kennedy - CMS Energy - Consumers Energy Company - 1,3,4,5 - RF	
Answer	No
Document Name	
Comment	
Likes 0	
Dislikes 0	
Response	
David Jendras - Ameren - Ameren Services - 1,3,6	
Answer	No
Document Name	
Comment	
Likes 0	
Dislikes 0	
Response	
Leonard Kula - Independent Electricity System Operator - 2	
Answer	No
Document Name	
Comment	
Likes 0	
Dislikes 0	

Response

Katherine Street - Duke Energy - 1,3,5,6 - SERC,RF, Group Name Duke Energy

Answer No

Document Name

Comment

Likes 0

Dislikes 0

Response

Anthony Jablonski - ReliabilityFirst - 10

Answer No

Document Name

Comment

Likes 0

Dislikes 0

Response

Allen Schriver - NextEra Energy - 5

Answer No

Document Name

Comment

Likes 0

Dislikes 0

Response

faranak sarbaz - Los Angeles Department of Water and Power - 1,3,5,6

Answer No

Document Name

Comment

Likes 0

Dislikes 0

Response**Bette White - AES - Indianapolis Power and Light Co. - 3****Answer**

No

Document Name**Comment**

Likes 0

Dislikes 0

Response**Thomas Foltz - AEP - 3,5****Answer**

No

Document Name**Comment**

Likes 0

Dislikes 0

Response**Karie Barczak - DTE Energy - Detroit Edison Company - 3,4,5, Group Name DTE Energy - DTE Electric****Answer**

No

Document Name**Comment**

Likes 0

Dislikes 0

Response

Matthew Nutsch - Seattle City Light - 1,3,4,5,6 - WECC

Answer No

Document Name

Comment

Likes 0

Dislikes 0

Response

Joshua Andersen - Salt River Project - 1,3,5,6 - WECC

Answer Yes

Document Name

Comment

If a Generator Owner owns the generator and a Transmission Owner the GSU, they should both have PRC-024 and PRC-025 compliance responsibility of their assets and coordinate via PRC-001. This has become a gray area in the industry of who has the compliance obligation. For example, the GO doesn't share or update the generator capability and characteristics so the TO can properly verify the associated coordination. And, it's difficult for the TO to be responsible for tracking the GO's generator information since it's not their asset.

In a different example, if the GO owns the generator and the GSU, because the standard doesn't dictate that the TO has PRC-024 or PRC-025 obligation on the inertia, this exclusion of language in the standard defeats the reliability intent.

Likes 0

Dislikes 0

Response

Michael Godbout - Hydro-Québec TransÉnergie - 1 - NPCC

Answer Yes

Document Name

Comment

Hydro-Québec TransÉnergie is a TO that owns the GSU associated with about 37 GW of generation which we do not own. We are not registered as a GO since we do not own any generators.

Likes 0

Dislikes 0

Response	
Richard Vine - California ISO - 2	
Answer	
Document Name	
Comment	
The California ISO supports the comments submitted by the ISO/RTO Council Standards Review Committee (SRC)	
Likes 0	
Dislikes 0	
Response	
Rachel Coyne - Texas Reliability Entity, Inc. - 10	
Answer	
Document Name	
Comment	
Texas RE does not have comments on this question.	
Likes 0	
Dislikes 0	
Response	

3. If you have any other comments on this SAR that you haven't already mentioned above, provide them here

Matthew Nutsch - Seattle City Light - 1,3,4,5,6 - WECC

Answer

Document Name

Comment

No other comments.

Likes 0

Dislikes 0

Response

Karie Barczak - DTE Energy - Detroit Edison Company - 3,4,5, Group Name DTE Energy - DTE Electric

Answer

Document Name

Comment

no.

Likes 0

Dislikes 0

Response

Bette White - AES - Indianapolis Power and Light Co. - 3

Answer

Document Name

Comment

None.

Likes 0

Dislikes 0

Response

faranak sarbaz - Los Angeles Department of Water and Power - 1,3,5,6

Answer

Document Name

Comment

NA

Likes 0

Dislikes 0

Response

Rachel Coyne - Texas Reliability Entity, Inc. - 10

Answer

Document Name

Comment

Texas RE recommends the SDT add "TO that owns synchronous condenser(s)" to the applicability of PRC-024, with "Synchronous condenser greater than 20 MVA (gross nameplate rating) directly connected to the Bulk Electric System" as an "applicable Facility." This addition would make the applicability of PRC-024 consistent with PRC-019-2 and MOD-025-2, and increase the reliability of the BES by requiring large Reactive Resources remain connected during voltage excursions.

Additionally, Texas RE recommends the SDT consider adding any dynamic Reactive Power resource (SVC, STATCOM, D-VAR) that meet a capability threshold as "applicable Facilities", as the loss of these resources during a voltage excursion can lead voltage instability on the BES.

Likes 0

Dislikes 0

Response

Anthony Jablonski - ReliabilityFirst - 10

Answer

Document Name

Comment

ReliabilityFirst supports the changes. We believe they address the issues in the "White Paper" and remove ambiguity and add clarity.

Likes 0

Dislikes 0

Response

Leonard Kula - Independent Electricity System Operator - 2

Answer

Document Name

Comment

The proposed standard requires to use the nominal voltages (e.g. 230 kV) as 1 pu for the voltage boundary curves that define No Trip Zone. The operating voltages boundaries can vary significantly around the nominal voltages. For example, there are entities that operate continuously at 250 kV facilities that have the nominal voltage of 230 kV. If the nominal voltage value is used in this case, there is a risk of tripping, considering that the overvoltage settings based on the nominal voltage might not provide enough margin to cover measuring errors.

We propose that the scope of the Supplemental SAR is expanded to allow for some margin to be added to the defined setting points when the continuous operating voltages exceed or are below the nominal voltages (e.g., by more than 5%).

There is also an error in the Table on Voltage Boundary Data Points in Attachment-2 (Voltage No-Trip Boundary – Eastern, Western, and ERCOT Interconnection) of the proposed standard.

The last line in the table currently shows the high voltage at less than or equal to 1.10 pu with a minimum time 4 seconds and the low voltage at greater than or equal to 0.90 pu with a minimum time 4 seconds:

“High Voltage at < 1.10 pu at Minimum Time 4.00 sec and Low Voltage at > 0.90 at Minimum Time 4.00 sec”.

However, consistent with the lines above, the high voltage should be at greater than or equal to 1.10 pu with a minimum time 4 seconds and the low voltage should be at less than or equal to 0.90 pu a minimum time 4 seconds. We propose the last line in the table be modified as follows:

“High Voltage at > 1.10 pu at Minimum Time 4.00 sec and Low Voltage at < 0.90 at Minimum Time 4.00 sec”.

Likes 0

Dislikes 0

Response

Sandra Kennedy - CMS Energy - Consumers Energy Company - 1,3,4,5 - RF

Answer

Document Name

Comment

None.

Likes 0

Dislikes 0

Response

Richard Jackson - U.S. Bureau of Reclamation - 1,5

Answer

Document Name

Comment

None

Likes 0

Dislikes 0

Response

Michelle Amarantos - APS - Arizona Public Service Co. - 1,3,5,6

Answer

Document Name

Comment

AZPS would like to reiterate its previous comments that were submitted in regards to Draft 1 of PRC-023-3. Please modify Attachment 2, Evaluation Protection Settings, number 1. c. as follows, because there is no realistic scenario where the high side voltage will be 1.1 pu or higher and the generator voltage will be at 0.95 pf lagging. It is most realistic to use lagging pf for low voltage conditions and leading pf for high voltage conditions.

For low voltage protection use Power factor is 0.95 lagging (i.e. supplying reactive power to the system) as measured at the generator terminals. For high voltage settings use Power factor is 0.95 leading (i.e. taking reactive power from the system) as measured at the generator terminals.

AZPS also reiterates concern with the addition of the TO as an applicable entity shifting compliance and cost responsibility from the GO/GOPs to TO/TOPs, which are distinct, separate entities.

Likes 0

Dislikes 0

Response

Michael Godbout - Hydro-Quebec TransEnergie - 1 - NPCC

Answer

Document Name

Comment

We were surprised that the SDT felt it needed to use a supplemental SAR to resolve the interpretative issue the SDT ran into regarding the scope of the SAR . That said, we strongly support this approach. The use of a supplemental SAR to clarify the scope of the project already underway seems to us an efficient way of raising this issue with industry and resolving it, rather than shipping it a few years down the road into a future project.

Likes 0

Dislikes 0

Response

Aaron Cavanaugh - Bonneville Power Administration - 1,3,5,6 - WECC

Answer

Document Name

Comment

None

Likes 0

Dislikes 0

Response

Bruce Reimer - Manitoba Hydro - 1,3,5,6

Answer

Document Name

Comment

In the Voltage Boundary Clarifications – Eastern, Western, and ERCOT Interconnections section; what does “The ‘no trip zone’ ends at 4 seconds” mean? Does it mean that there is not a standard concern if the relay trips beyond the 4 second time? Why was the 4 seconds chosen?

Likes 0

Dislikes 0

Response

Mark Gray - Edison Electric Institute - NA - Not Applicable - NA - Not Applicable

Answer

Document Name

Comment

EEl member companies believe that NERC has more effective methods and tools available that they could use to collect data and identify technical justifications for reliability gaps.

Likes 0

Dislikes 0

Response

Richard Vine - California ISO - 2

Answer

Document Name

Comment

The California ISO supports the comments submitted by the ISO/RTO Council Standards Review Committee (SRC)

Likes 0

Dislikes 0

Response

Charles Yeung - Southwest Power Pool, Inc. (RTO) - 2, Group Name SRC

Answer

Document Name

Comment

We ask what the rationale is for using the nominal voltage and not the operating voltage for the voltage boundary curves. The operating voltages boundaries can vary significantly around the nominal voltages (e.g. 230 kV as 1 p.u.) that define the No Trip Zone. For example, if an entity operates facilities continuously at 250 kV and the nominal voltage of 230 kV 1 p.u. is used in this case, there is a risk of premature tripping considering that the overvoltage settings based on the nominal voltage might not provide enough margin to cover measuring errors.

Likes 0

Dislikes 0

Response

Jodirah Green - ACES Power Marketing - 1,3,4,5,6 - MRO,WECC,Texas RE,SERC,RF, Group Name ACES Standard Collaborations

Answer

Document Name

Comment

Thank you for the opportunity to comment.

Likes 0

Dislikes 0

Response

Teresa Cantwell - Lower Colorado River Authority - 1,5, Group Name LCRA Compliance

Answer

Document Name

Comment

None.

Likes 0

Dislikes 0

Response

Amy Casuscelli - Xcel Energy, Inc. - 1,3,5,6 - MRO,WECC

Answer

Document Name

Comment

Xcel Energy believes the reliability or compliance gaps described in the Requested Information section of the SAR exist for all synchronous machines GSU transformers which have microprocessor based transformer protection relays applied that have the capability to provide voltage, frequency and volts/Hz protection functions. Virtually all major transformer protection manufacturers provide relays with these functions available. As such, the gaps described in the SAR are wide spread throughout the industry. While there is likely a very small population of GSUs owned by TOs for which this type

of protection is enabled, there is a very high portion of GO owned GSU which will continue to have the these reliability and compliance gaps if GSU transformer protection is excluded from the standard.

Likes 0

Dislikes 0

Response

Douglas Webb - Great Plains Energy - Kansas City Power and Light Co. - 1,3,5,6 - MRO, Group Name Westar-KCPL

Answer

Document Name

Comment

None.

Likes 0

Dislikes 0

Response

Joel Dembowski - Southern Company - Alabama Power Company - 3, Group Name Southern Company

Answer

Document Name

Comment

The use of a supplemental SAR for the stated purpose is not clearly aligned with guidance in the Standards Process Manual.

Likes 0

Dislikes 0

Response

Constantin Chitescu - Ontario Power Generation Inc. - 5

Answer

Document Name

[PRC-024-3 Outreach Questions.docx](#)

Comment

The Supplemental SAR section “Purpose or Goal (How does this proposed project provide the reliability-related benefit described above?):” states the following:

“Ensure the voltage and frequency protection on all applicable equipment (including the GSU or collector transformer) up to the point of interconnection that could cause a generating resource to trip or cease to inject current meets the voltage and frequency ride-through requirements of PRC-024, thus enabling the generating resource to support grid stability during defined system voltage and frequency excursions. Project”

PRC-024-2 does not have frequency ride through requirements, and merely sets the requirements for the generator frequency protective relays settings. Ride through implies performance criteria.

Also generating resources can negatively impact the grids reliability not only by ceasing to inject current, but also through a sensible reduction of the amount of current being injected. This is not currently covered by the existing standard nor by the proposed draft.

Consideration should be given also to revising the existing SAR (i.e. add to the parameters of the proposed project).

Please see attached the OPG comments for the SDT outreach questions.

Likes 0

Dislikes 0

Response

Ruida Shu - Northeast Power Coordinating Council - 1,2,3,4,5,6,7,8,9,10 - NPCC, Group Name RSC no Dominion and HQ

Answer

Document Name

Comment

A Standard Authorization Request (SAR) comment form should not be used to collect data needed to justify the SAR. If data needs to be collected, then a Section 1600 data request could be considered. After data is collected, then a determination can be made regarding next steps. The applicability of PRC-024 should remain as Generator Owners, at this time.

Likes 0

Dislikes 0

Response

Armin Klusman - CenterPoint Energy Houston Electric, LLC - 1 - Texas RE

Answer

Document Name

Comment

No

Likes 0

Dislikes 0

Response

Standard Development Timeline

This section is maintained by the drafting team during the development of the standard and will be removed when the standard is adopted by the NERC Board of Trustees (Board).

Description of Current Draft

PRC-024-3 is posted for a 45-day formal comment period with additional ballot.

Completed Actions	Date
Standards Committee approved Standard Authorization Request (SAR) for posting	December 2018
SAR posted for comment	December 2018 – January 2019
Standards Committee accepted the revised SAR	February 2019
45-day formal comment period with ballot	April – May 2019

Anticipated Actions	Date
45-day formal or informal comment period with additional ballot	September – November 2019
10-day final ballot	November 2019
Board adoption	February 2020

A. Introduction

1. **Title:** Frequency and Voltage Protection Settings for Generating Resources
2. **Number:** PRC-024-3
3. **Purpose:** To set protection such that generating resource(s) remain connected during defined frequency and voltage excursions in support of the Bulk Electric System (BES).
4. **Applicability:**
 - 4.1. **Functional Entities:**
 - 4.1.1. Generator Owners that apply protection listed in Section 4.2.1.
 - 4.1.2. Transmission Owners (in the Quebec Interconnection only) that own a BES generator step-up (GSU) transformer or main power transformer (MPT) and apply protection listed in Section 4.2.1.
 - 4.1.3. Planning Coordinators (in the Quebec Interconnection only)
 - 4.2. **Facilities¹:**
 - 4.2.1 Frequency, voltage, and volts per hertz protection (whether provided by relaying or functions within associated control systems) that respond to electrical signals and: (i) directly trip the generating resource(s); or (ii) provide signals to the generating resource(s) to either trip or cease injecting current; and are applied to the following:
 - 4.2.1.1 BES generating resource(s).
 - 4.2.1.2 BES GSU transformer(s).
 - 4.2.1.3 High side of the generator-connected unit auxiliary transformer² (UAT) installed on BES generating resource(s).
 - 4.2.1.4 Individual dispersed power producing resource(s) identified in the BES Definition, Inclusion I4.
 - 4.2.1.5 Elements that are designed primarily for the delivery of capacity from the individual dispersed power producing resources identified in the BES Definition, Inclusion I4, to the point where those resources aggregate to greater than 75 MVA.

¹ It is not required to install or activate the protections described in Facilities Section 4.2.

² These transformers are variably referred to as station power UAT, or station service transformer(s) used to provide overall auxiliary power to the generating resource(s). This UAT is the transformer connected on the generator bus between the low side of the GSU and the generator terminal.

4.2.1.6 MPT of resource(s) identified in the BES Definition, Inclusion I4.

4.2.2 Exemptions: Protection on all auxiliary equipment within the generating Facility.

5. Effective Date: See Implementation Plan for PRC-024-3

B. Requirements and Measures

- R1.** Each Generator Owner shall set its applicable frequency protection³ in accordance with PRC-024 Attachment 1 such that the applicable protection does not cause the generating resource to trip or cease injecting current within the “no trip zone” during a frequency excursion with the following exception: *[Violation Risk Factor: Medium] [Time Horizon: Long-term Planning]*
- Applicable frequency protection may be set to trip or cease injecting current within a portion of the “no trip zone” for documented and communicated regulatory or equipment limitations in accordance with Requirement R3.
- M1.** Each Generator Owner shall have evidence that the applicable frequency protection has been set in accordance with Requirement R1, such as dated setting sheets, calibration sheets, calculations, or other documentation.
- R2.** Each Generator Owner shall set its applicable voltage protection³ in accordance with PRC-024 Attachment 2, such that the applicable protection does not cause the generating resource to trip or cease injecting current within the “no trip zone” during a voltage excursion at the high side of the GSU or MPT, subject to the following exceptions: *[Violation Risk Factor: Medium] [Time Horizon: Long-term Planning]*
- If the Transmission Planner allows less stringent voltage protection settings than those required to meet PRC-024 Attachment 2, then the Generator Owner may set its protection within the voltage recovery characteristics of a location-specific Transmission Planner’s study.
 - Applicable voltage protection may be set to trip or cease injecting current during a voltage excursion within a portion of the “no trip zone” for documented and communicated regulatory or equipment limitations in accordance with Requirement R3.
- M2.** Each Generator Owner shall have evidence that applicable voltage protection has been set in accordance with Requirement R2, such as dated setting sheets, voltage-time boundaries, calibration sheets, coordination plots, dynamic simulation studies, calculations, or other documentation.
- R3.** Each Generator Owner shall document each known regulatory or equipment limitation⁴ that prevents an applicable generating resource(s) with frequency or voltage protection from meeting the protection setting criteria in Requirements R1 or R2, including (but not limited to) study results, experience from an actual event, or

³ Frequency, voltage, and volts per hertz protection (whether provided by relaying or functions within associated control systems) that respond to electrical signals and: (i) directly trip the generating resource(s); or (ii) provide signals to the generating resource(s) to either trip or cease injecting current.

⁴ Excludes limitations caused by the setting capability of the frequency and voltage protective relays for the generating resource(s) but does not exclude limitations originating in the equipment that the relays protect or frequency and voltage protection embedded in control systems.

manufacturer's advice. *[Violation Risk Factor: Lower] [Time Horizon: Long-term Planning]*

- 3.1.** The Generator Owner shall communicate the documented regulatory or equipment limitation, or the removal of a previously documented regulatory or equipment limitation, to its Planning Coordinator and Transmission Planner within 30 calendar days of any of the following:
- Identification of a regulatory or equipment limitation.
 - Repair of the equipment causing the limitation that removes the limitation.
 - Replacement of the equipment causing the limitation with equipment that removes the limitation.
 - Creation or adjustment of an equipment limitation caused by consumption of the cumulative turbine life-time frequency excursion allowance.
- M3.** Each Generator Owner shall have evidence that it has documented and communicated any known regulatory or equipment limitations that resulted in an exception to Requirements R1 or R2 in accordance with Requirement R3, such as a dated email or letter that contains such documentation as study results, experience from an actual event, or manufacturer's advice.
- R4.** Each Generator Owner shall provide its applicable protection settings associated with Requirements R1 and R2 to the Planning Coordinator or Transmission Planner that models the associated generating resource(s) within 60 calendar days of receipt of a written request for the data and within 60 calendar days of any change to those previously requested settings unless directed by the requesting Planning Coordinator or Transmission Planner that the reporting of protection setting changes is not required. *[Violation Risk Factor: Lower] [Time Horizon: Operations Planning]*
- M4.** Each Generator Owner shall have evidence that it communicated applicable protection settings in accordance with Requirement R4, such as dated e-mails, correspondence or other evidence and copies of any requests it has received for that information.

C. Compliance

1. Compliance Monitoring Process

1.1. Compliance Enforcement Authority: “Compliance Enforcement Authority” means NERC or the Regional Entity, or any entity as otherwise designated by an Applicable Governmental Authority, in their respective roles of monitoring and/or enforcing compliance with mandatory and enforceable Reliability Standards in their respective jurisdictions.

1.2. Evidence Retention: The following evidence retention period(s) identify the period of time an entity is required to retain specific evidence to demonstrate compliance. For instances where the evidence retention period specified below is shorter than the time since the last audit, the Compliance Enforcement Authority may ask an entity to provide other evidence to show that it was compliant for the full-time period since the last audit.

The applicable entity shall keep data or evidence to show compliance as identified below unless directed by its Compliance Enforcement Authority to retain specific evidence for a longer period of time as part of an investigation.

- The Generator Owner shall keep data or evidence of Requirements R1 through R4 for 3 years or until the next audit, whichever is longer.
- If a Generator Owner is found non-compliant, the Generator Owner or Transmission Owner shall keep information related to the non-compliance until mitigation is complete and approved for the time period specified above, whichever is longer.

1.3. Compliance Monitoring and Enforcement Program: As defined in the NERC Rules of Procedure, “Compliance Monitoring and Enforcement Program” refers to the identification of the processes that will be used to evaluate data or information for the purpose of assessing performance or outcomes with the associated Reliability Standard.

Violation Severity Levels

R #	Violation Severity Levels			
	Lower VSL	Moderate VSL	High VSL	Severe VSL
R1.	N/A	N/A	N/A	The Generator Owner failed to set its applicable frequency protection so that it does not trip or enter momentary cessation according to Requirement R1.
R2.	N/A	N/A	N/A	The Generator Owner failed to set its applicable voltage protection so that it does not trip or enter momentary cessation according to Requirement R2.
R3.	The Generator Owner documented the known non-protection system equipment limitation that prevented it from meeting the criteria in Requirement R1 or R2 and communicated the documented limitation to its Planning Coordinator and Transmission Planner more than 30 calendar days but less than or equal to 60	The Generator Owner documented the known non-protection system equipment limitation that prevented it from meeting the criteria in Requirement R1 or R2 and communicated the documented limitation to its Planning Coordinator and Transmission Planner more than 60 calendar days but less than or equal to 90	The Generator Owner documented the known non-protection system equipment limitation that prevented it from meeting the criteria in Requirement R1 or R2 and communicated the documented limitation to its Planning Coordinator and Transmission Planner more than 90 calendar days but less than or equal to 120	The Generator Owner failed to document any known non-protection system equipment limitation that prevented it from meeting the criteria in Requirement R1 or R2. OR The Generator Owner failed to communicate the documented limitation to its Planning Coordinator and Transmission Planner within

R #	Violation Severity Levels			
	Lower VSL	Moderate VSL	High VSL	Severe VSL
	calendar days of identifying the limitation.	calendar days of identifying the limitation.	calendar days of identifying the limitation.	120 calendar days of identifying the limitation.
R4.	<p>The Generator Owner provided its protection settings more than 60 calendar days but less than or equal to 90 calendar days of any change to those settings.</p> <p>OR</p> <p>The Generator Owner provided protection settings more than 60 calendar days but less than or equal to 90 calendar days of a written request.</p>	<p>The Generator Owner provided its protection settings more than 90 calendar days but less than or equal to 120 calendar days of any change to those settings.</p> <p>OR</p> <p>The Generator Owner provided protection settings more than 90 calendar days but less than or equal to 120 calendar days of a written request.</p>	<p>The Generator Owner provided its protection settings more than 120 calendar days but less than or equal to 150 calendar days of any change to those settings.</p> <p>OR</p> <p>The Generator Owner or provided protection settings more than 120 calendar days but less than or equal to 150 calendar days of a written request.</p>	<p>The Generator Owner failed to provide its protection settings within 150 calendar days of any change to those settings.</p> <p>OR</p> <p>The Generator Owner failed to provide protection settings within 150 calendar days of a written request.</p>

D. Regional Variances

D.A. Variance for the Quebec Interconnection

This Variance extends the applicability of Requirements R1, R3, and R4 to Transmission Owners in the Quebec Interconnection that own a BES GSU or MPT and apply protection listed in Section 4.2.1, Facilities. This Variance also replaces Requirement R2 of the continent-wide standard in its entirety and adds a new requirement, Requirement D.A.5., applicable to Planning Coordinators in the Quebec Interconnection.

In Requirements R1, R3, and R4, all references to “Generator Owner” are replaced with “Generator Owner and Transmission Owner.”

This Variance replaces continent-wide Requirement R2 in its entirety with the following:

D.A.2. Each Generator Owner and Transmission Owner shall set its applicable voltage protection³ in accordance with PRC-024 Attachment 2a, such that the applicable protection does not cause the generating resource to trip or cease injecting current during a voltage excursion within the “no trip zone” at the high side of the GSU or MPT, subject to the following exceptions: *[Violation Risk Factor: Medium] [Time Horizon: Long-term Planning]*

- For newly designated strategic power plants, applicable protections must comply with the high voltage durations for such plants within 48 calendar months of the notification made pursuant to Requirement D.A.5. During this transition period, voltage protections must at least comply with the high voltage durations for “all power plants”.
- The generating resource(s) are permitted to be set to trip or to cease injecting current during a voltage excursion bounded by the “no trip zone” of PRC-024 Attachment 2a for documented and communicated regulatory or equipment limitations in accordance with Requirement R3.
- If the Transmission Planner allows less stringent voltage protection settings than those required to meet PRC-024 Attachment 2a, then the Generator Owner or Transmission Owner may set its protection within the voltage recovery characteristics of a location-specific Transmission Planner’s study.
- Inverter-based resources voltage protection settings may be set to cease injecting current momentarily during a voltage excursion at the high side of the MPT, bounded by the “no trip zone” of PRC-024 Attachment 2a, under the following conditions:

- After a minimum delay of 0.022 s, when the positive-sequence voltage exceeds 1.25 per unit (p.u.) Normal operation must resume once the voltage drops back below 1.25 p.u at the high side of the MPT.
- After a minimum delay of 0.022 s, when the phase-to-ground root mean square (RMS) voltages exceeds 1.4 p.u., as measured at generator terminals, on one or multiple phases. Normal operation must resume once the positive-sequence voltage drops back below the 1.25 p.u. at the high side of the MPT.

M.D.A.2. Each Generator Owner and Transmission Owner shall have evidence that applicable voltage protection has been set in accordance with Requirement R2, such as dated setting sheets, voltage-time boundaries, calibration sheets, coordination plots, dynamic simulation studies, calculations, or other documentation.

This Variance adds the following Requirement:

- D.A.5** Each Planning Coordinator shall designate, at least once every five calendar years, the strategic power plants that must comply with Attachment 2a and notify, within 30 calendar days of its designation, each Generator Owner or Transmission Owner that owns facilities⁵ in the strategic power plants. *[Violation Risk Factor: Medium] [Time Horizon: Long-term planning]*
- M.D.A.5** Each Planning Coordinator shall have evidence that it designated, at least once every five calendar years, strategic power plants in accordance with Requirement D.A.5, Part 5 and shall have dated evidence that each Generator Owner or Transmission Owner has been notified in accordance with Requirement D.A.5, part 5.2. Evidence may include, but is not limited to: letters, emails, electronic files, or hard copy records demonstrating transmittal of information.

⁵ Facilities in the strategic power plants include facilities from the generator up to and including the MPT or GSU.

Violation Severity Levels

This Variance adds a VSL for D.A.5 and modifies the VSL for R2 as follows:

R #	Violation Severity Levels			
	Lower VSL	Moderate VSL	High VSL	Severe VSL
D.A.2.	N/A	N/A	N/A	<p>The Generator Owner or Transmission Owner failed to set its applicable voltage protection so that it does not trip or enter momentary cessation in accordance with Requirement D.A.2.</p> <p>OR</p> <p>The Generator Owner or Transmission Owner set its applicable voltage protection in accordance with Requirement D.A.2 but, for strategic power plants, failed to do so within 48 months of notification.</p>
D.A.5.	N/A	The Planning Coordinator designated strategic power plants at least once every five calendar years but notified each Generator Owner or Transmission Owner that owns	The Planning Coordinator designated strategic power plants at least once every five calendar years but notified each Generator Owner or Transmission Owner that owns	The Planning Coordinator failed to designate, at least once every five years, the strategic power plants that must comply with Attachment 2a.

R #	Violation Severity Levels			
	Lower VSL	Moderate VSL	High VSL	Severe VSL
		facilities in the strategic power plants between 31 days and 45 days after its designation.	facilities in the strategic power plants between 46 days and 60 days after its designation.	OR The Planning Coordinator failed to notify, each Generator Owner or Transmission Owner that owns facilities in the strategic power plants or notified them more than 60 days after the its designation.

E. Associated Documents

Implementation Plan

Version History

Version	Date	Action	Change Tracking
1	May 9, 2013	Adopted by the NERC Board of Trustees	
1	March 20, 2014	FERC Order issued approving PRC-024-1. (Order becomes effective on 7/1/16.)	
2	February 12, 2015	Adopted by the NERC Board of Trustees	Standard revised in Project 2014-01: Applicability revised to clarify application of requirements to BES dispersed power producing resources
2	May 29, 2015	FERC Letter Order in Docket No. RD15-3-000 approving PRC-024-2	Modifications to adjust the applicability to owners of dispersed generation resources.

Attachment 1 (Frequency No Trip Boundaries by Interconnection⁶)

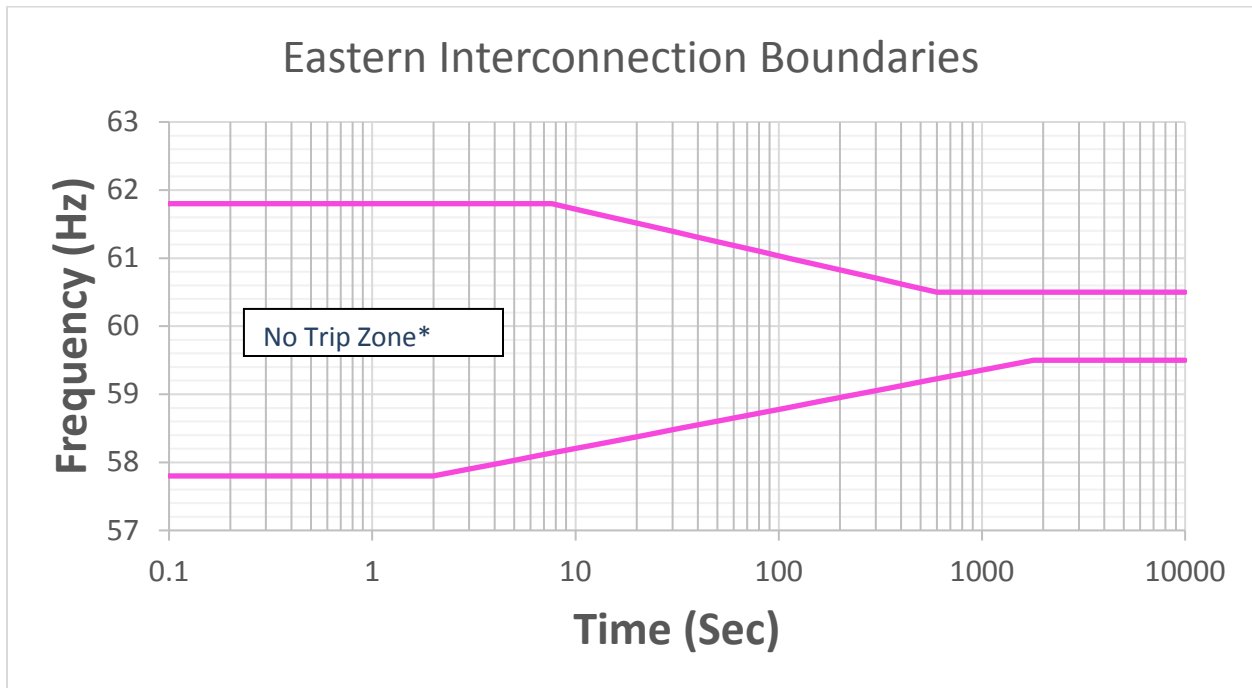

Figure 1

** The area outside the "No Trip Zone" is not a "Must Trip Zone."*

Frequency Boundary Data Points – Eastern Interconnection

High Frequency Duration		Low Frequency Duration	
Frequency (Hz)	Minimum Time (Sec)	Frequency (Hz)	Minimum Time (sec)
≥61.8	Instantaneous ⁷	≤57.8	Instantaneous ⁷
≥60.5	$10^{(90.935-1.45713*f)}$	≤59.5	$10^{(1.7373*f-100.116)}$
<60.5	Continuous operation	> 59.5	Continuous operation

Table 1

⁶ The figures do not visually represent the “no trip zone” boundaries before 0.1 seconds and after 10,000 seconds. The Frequency Boundary Data Points Table defines the entirety of the “no trip zone” boundaries.

⁷ Frequency is calculated over a window of time. While the frequency boundaries include the option to trip instantaneously for frequencies outside the specified range, this calculation should occur over a time window. Typical window/filtering lengths are three to six cycles (50 – 100 milliseconds). Instantaneous trip settings based on instantaneously calculated frequency measurement is not permissible.

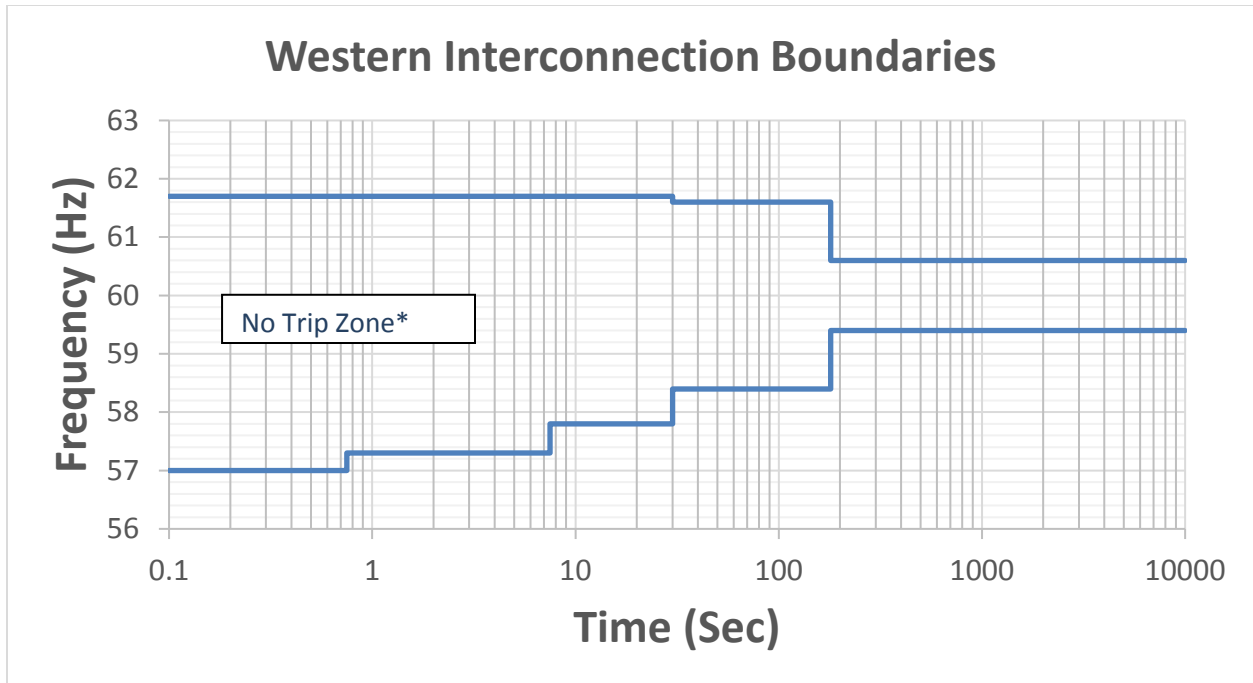

Figure 2

* The area outside the "No Trip Zone" is not a "Must Trip Zone."

Frequency Boundary Data Points – Western Interconnection

High Frequency Duration		Low Frequency Duration	
Frequency (Hz)	Minimum Time (Sec)	Frequency (Hz)	Minimum Time (sec)
≥61.7	Instantaneous ⁷	≤57.0	Instantaneous ⁷
≥61.6	30	≤57.3	0.75
≥60.6	180	≤57.8	7.5
<60.6	Continuous operation	≤58.4	30
		≤59.4	180
		>59.4	Continuous operation

Table 2

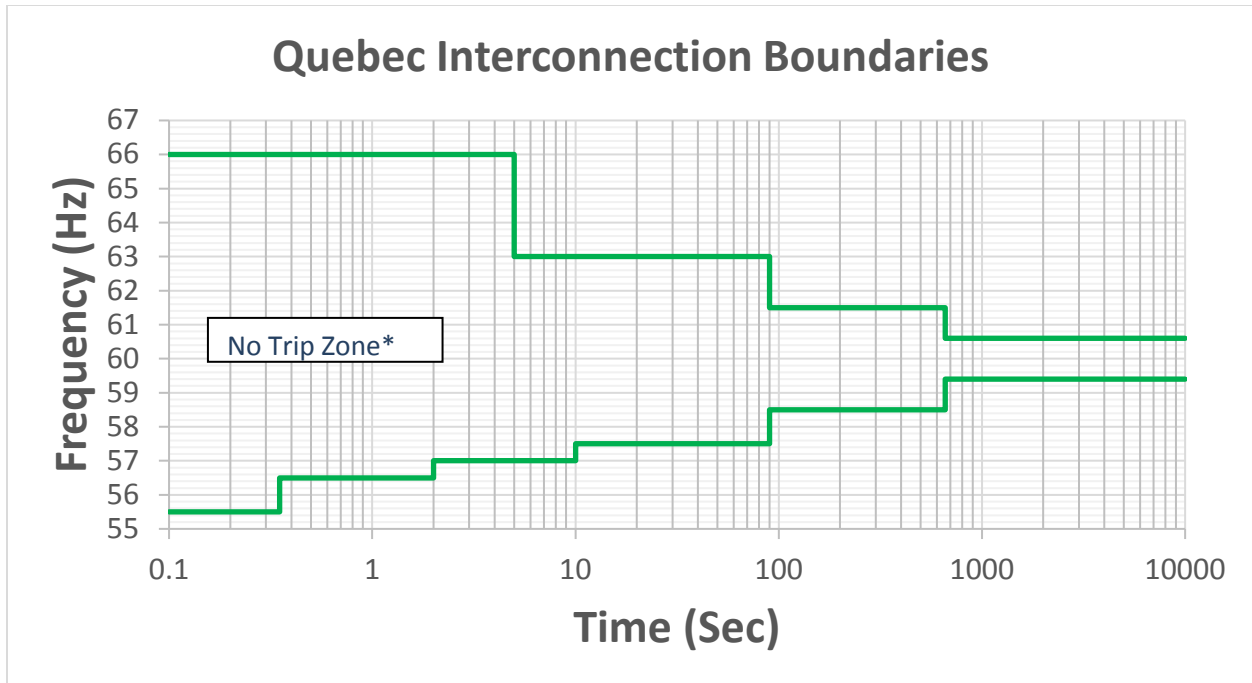

Figure 3

* The area outside the "No Trip Zone" is not a "Must Trip Zone."

Frequency Boundary Data Points – Quebec Interconnection

High Frequency Duration		Low Frequency Duration	
Frequency (Hz)	Minimum Time (Sec)	Frequency (Hz)	Minimum Time (Sec)
>66.0	Instantaneous ⁷	<55.5	Instantaneous ⁷
≥63.0	5	≤56.5	0.35
≥61.5	90	≤57.0	2
≥60.6	660	≤57.5	10
<60.6	Continuous operation	≤58.5	90
		≤59.4	660
		>59.4	Continuous operation

Table 3

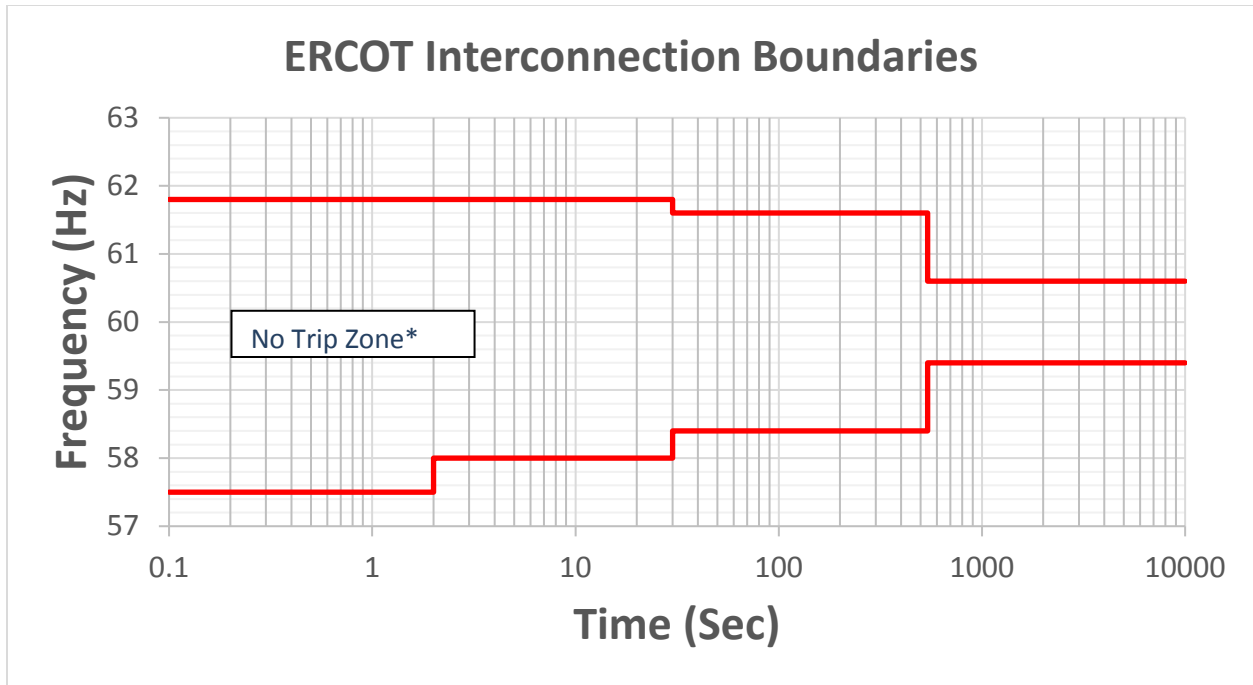

Figure 4

* The area outside the "No Trip Zone" is not a "Must Trip Zone."

Frequency Boundary Data Points – ERCOT Interconnection

High Frequency Duration		Low Frequency Duration	
Frequency (Hz)	Minimum Time (Sec)	Frequency (Hz)	Minimum Time (sec)
≥61.8	Instantaneous ⁷	≤57.5	Instantaneous ⁷
≥61.6	30	≤58.0	2
≥60.6	540	≤58.4	30
<60.6	Continuous operation	≤59.4	540
		>59.4	Continuous operation

Table 4

PRC-024 — Attachment 2

(Voltage No-Trip Boundaries – Eastern, Western, and ERCOT Interconnections)

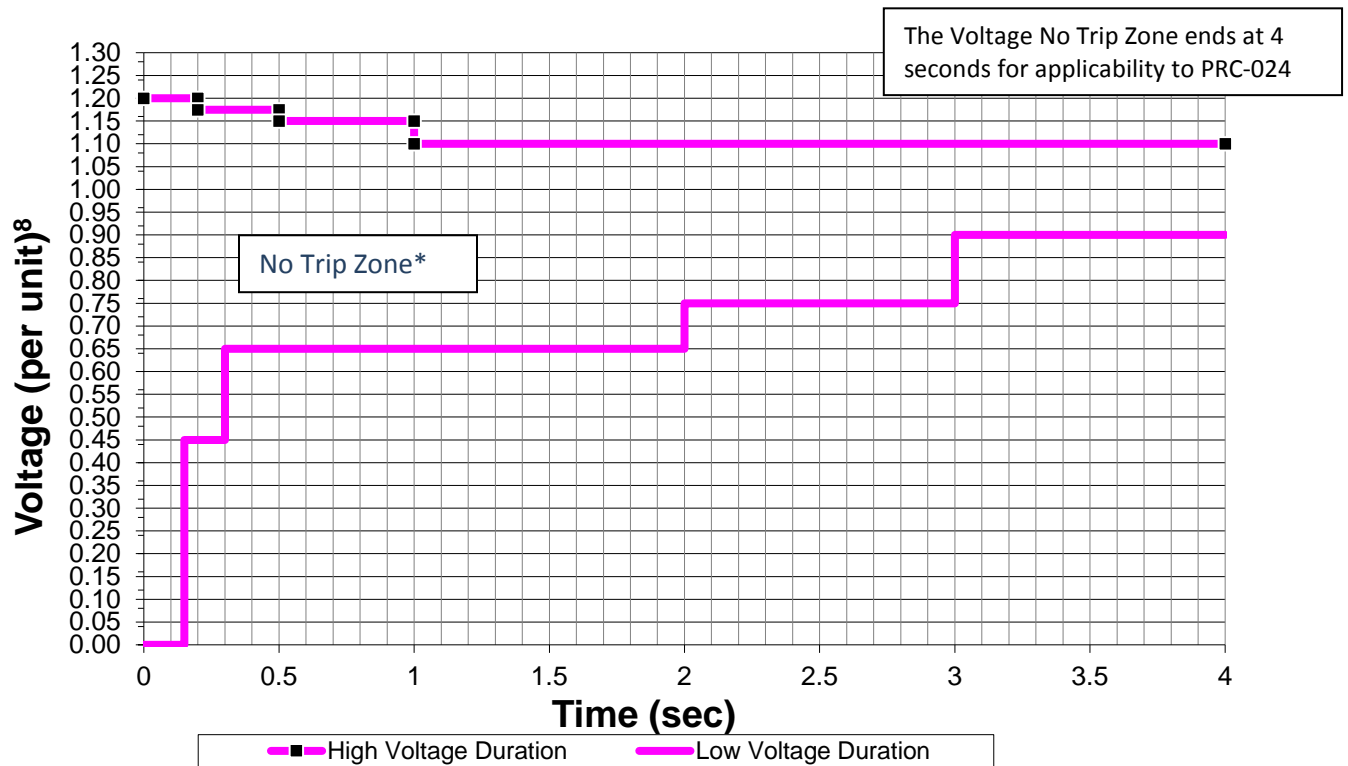

Figure 1

** The area outside the "No Trip Zone" is not a "Must Trip Zone."*

Voltage Boundary Data Points

High Voltage Duration		Low Voltage Duration	
Voltage (pu)	Minimum Time (sec)	Voltage (pu)	Minimum Time (sec)
≥1.200	0.00	<0.45	0.15
≥1.175	0.20	<0.65	0.30
≥1.15	0.50	<0.75	2.00
≥1.10	1.00	<0.90	3.00
<1.10	4.00	≥ 0.90	4.00

Table 1

⁸Voltage at the high-side of the GSU or MPT.

Attachment 2: Voltage Boundary Clarifications – Eastern, Western, and ERCOT Interconnections

Boundary Details:

1. Unless otherwise specified by the Transmission Planner, the per unit voltage base for these boundaries is the nominal transmission system voltage (e.g., 100 kV, 115 kV, 138 kV, 161 kV, 230 kV, 345 kV, 400 kV, 500 kV, 765 kV, etc.).
2. The values in the table represent the minimum time durations allowed for specified voltage excursion thresholds.
3. When evaluating volts per hertz protection, either assume a system frequency of 60 Hertz or the magnitude of the high voltage boundary can be adjusted in proportion to deviations of frequency below 60 Hertz.
4. Voltages in the boundaries assume RMS fundamental frequency phase-to-ground or phase-to-phase per unit voltage.
5. For applicability to PRC-024, the “no trip zone” ends at 4 seconds.

Evaluating Protection Settings:

The voltage values in the Attachment 2 voltage boundaries are voltages at the high side of the GSU/MPT. For generating resources with multiple stages of step up to reach interconnecting voltage, this is the high side of the transformer with a low side below 100kV and a high side 100kV or above. When evaluating protection settings, consider the voltage differences between where the protection is measuring voltage and the high side of the GSU/MPT. A steady state calculation or dynamic simulation may be used.

If using a steady state calculation or dynamic simulation, use the following conditions when evaluating protection settings:

- a. The most probable real and reactive loading conditions for the unit under study.
- b. All installed generating plant reactive support (e.g., static VAR compensators, synchronous condensers, capacitors) equipment is available and operating normally.
- c. Account for the actual tap settings of transformers between the generator terminals and the high side of the GSU/MPT.
- d. For dynamic simulations, the automatic voltage regulator is in automatic voltage control mode with associated limiters in service.

PRC-024— Attachment 2a (Voltage No-Trip Boundaries – Quebec Interconnection)

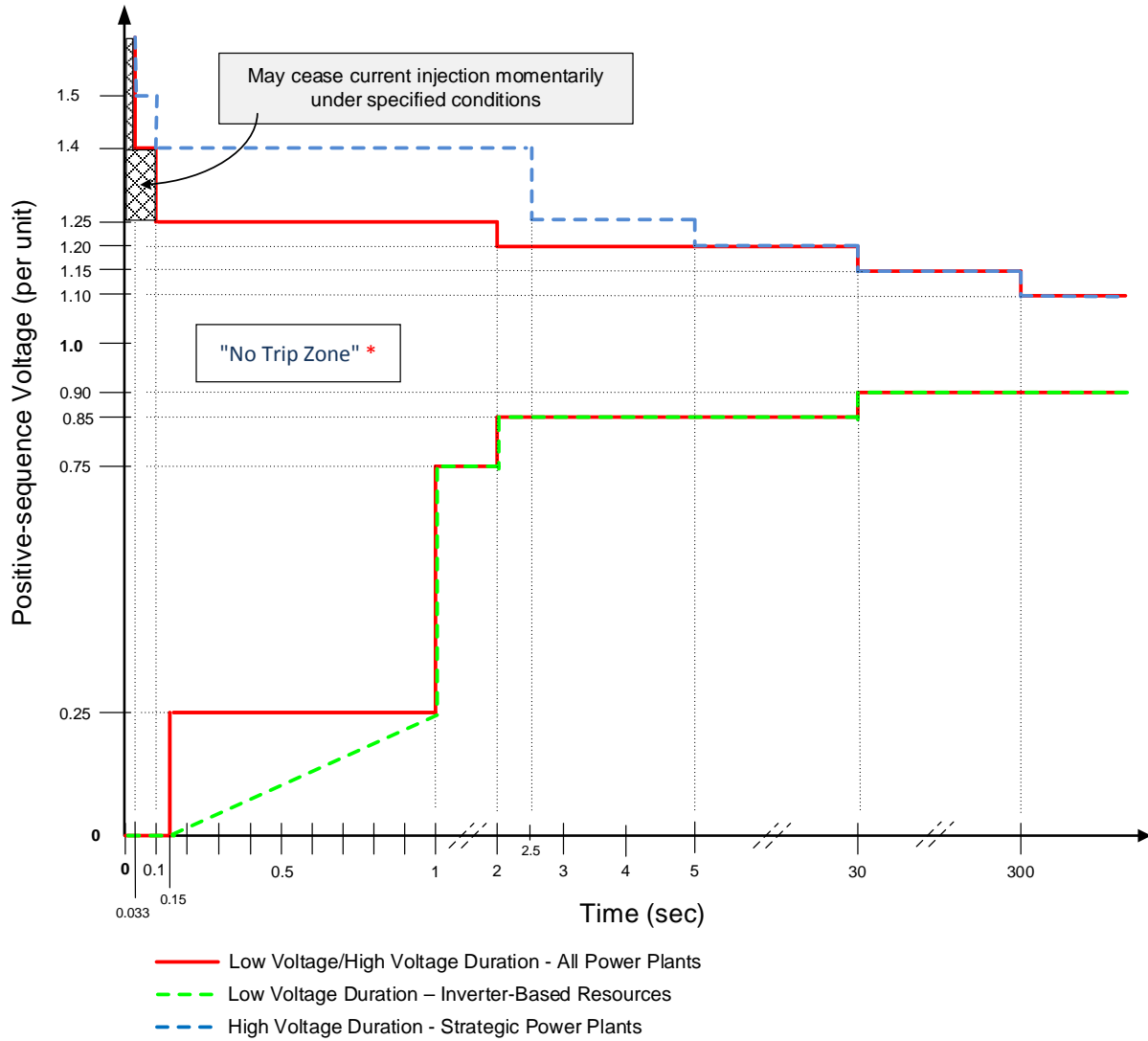

Figure 1

*** The area outside the "No Trip Zone" is not a "Must Trip Zone."**

Voltage Boundary Data Points – Quebec Interconnection

High Voltage Duration for all Power Plants		High Voltage Duration for strategic ¹ Power Plants	
Voltage (pu)	Minimum Time (sec)	Voltage (pu)	Minimum Time (sec)
---	---	>1.50	0.033
>1.40	0.033	>1.40	0.10
>1.25	0.10	>1.25	2.50
>1.20	2.00	>1.20	5.00
>1.15	30	>1.15	30
>1.10	300	>1.10	300
≤1.10	continuous	≤1.10	continuous

Table 1

Voltage Boundary Data Points – Quebec Interconnection

Low Voltage Duration for all Power Plants		Low Voltage Duration for Inverter-Based Resources	
Voltage (pu)	Minimum Time (sec)	Voltage (pu)	Minimum Time (sec)
<0.25	0.15	<0.25	$3.4 * V(\text{pu}) + 0.15$
<0.75	1.00	<0.75	1.00
<0.85	2.00	<0.85	2.00
<0.90	30	<0.90	30
≥0.90	continuous	≥0.90	continuous

Table 2

Attachment 2a: Voltage Boundary Clarifications – Quebec Interconnection

Boundary Details:

1. The per unit voltage base for these boundaries is the nominal operating voltage (e.g., 120 kV, 161 kV, 230 kV, 315 kV, 735 kV, etc.).
2. The values in the table represent the minimum time durations allowed for specified voltage excursion thresholds.
3. When evaluating volts per hertz protection, either assume a system frequency of 60 Hertz or the magnitude of the high voltage boundary can be adjusted in proportion to deviations of frequency below 60 Hertz.
4. Voltages in the Quebec Interconnection boundaries assume positive-sequence values.

Evaluating Protection Settings:

The voltage values in the Attachment 2a voltage boundaries are voltages at the high side of the GSU/MPT. For generating resources with multiple stages of step up to reach interconnecting voltage, this is the high side of the transformer that connects to the interconnecting voltage. When evaluating protection settings, consider the voltage differences between where the protection is measuring voltage and the high side of the GSU/MPT. A steady state calculation or dynamic simulation may be used.

If using a steady state calculation or dynamic simulation, use the following conditions when evaluating protection settings:

- a. The most probable real and reactive loading conditions for the unit under study.
- b. All installed generating plant reactive support (e.g., static VAR compensators, synchronous condensers, capacitors) equipment is available and operating normally.
- c. Account for the actual tap settings of transformers between the generator terminals and the high side of the GSU/MPT.
- d. For dynamic simulations, the automatic voltage regulator is in automatic voltage control mode with associated limiters in service.

Standard Development Timeline

This section is maintained by the drafting team during the development of the standard and will be removed when the standard is adopted by the NERC Board of Trustees (Board).

Description of Current Draft

PRC-024-3 is posted for a 45-day formal comment period with additional ballot.

Completed Actions	Date
Standards Committee approved Standard Authorization Request (SAR) for posting	December 2018
SAR posted for comment	December 2018 – January 2019
Standards Committee accepted the revised SAR	February 2019
45-day formal comment period with ballot	April – May 2019

Anticipated Actions	Date
45-day formal or informal comment period with additional ballot	September – November 2019
10-day final ballot	November 2019
Board adoption	February 2020

A. Introduction

1. **Title:** ~~Generator~~ Frequency and Voltage Protection Settings for Generating Resources
2. **Number:** PRC-024-3
3. **Purpose:** To set ~~generator~~ protection, such that generating resource(s) remain ~~connected, continuing to support the BES~~ during defined frequency and ~~voltage excursions in support of the Bulk Electric System (BES).~~ voltage excursions in support of the Bulk Electric System (BES).

4. **Applicability:**

- 4.1. **Functional Entities:**

- 4.1.1. Generator Owners that apply protection listed in Section 4.2.1.

- 4.1.2. Transmission Owners (in the Quebec Interconnection only) that own a BES generator step-up (GSU) transformer or ~~collector transformer~~ main power transformer (MPT) and apply protection listed in Section 4.2.1.

- 4.1.2.4.1.3. Planning Coordinators (in the Quebec Interconnection only).

- 4.2. **Facilities¹:**

- 4.2.1 Frequency, voltage, ~~or and~~ volts per hertz protection (whether provided by relaying or, including frequency or voltage protective functions within associated control systems) that provide tripping or momentary cessation signals to all or part of the generating resource, that respond to electrical signals and: (i) directly trip the generating resource(s); or (ii) provide signals to the generating resource(s) to either trip or cease injecting current; and are applied to the following:

- 4.2.1.1 ~~Bulk Electric System (BES)~~ generating resource(s).

- 4.2.1.2 BES GSU transformer(s).

- 4.2.1.3 High side of the generator-connected unit auxiliary transformer² (UAT) installed on BES generating resource(s).

- 4.2.1.4 Individual dispersed power producing resource(s) identified in the BES Definition, Inclusion I4.

- 4.2.1.5 Elements ~~utilized in aggregation of that are designed primarily for the delivery of capacity from the individual~~ the dispersed power producing resources identified in the BES Definition,

¹ It is not required to install or activate the protections described in Facilities Section 4.2.

² These transformers are variably referred to as station power UAT, or station service transformer(s) used to provide overall auxiliary power to the generating resource(s). This UAT is the transformer connected on the generator bus between the low side of the GSU and the generator terminal.

PRC-024-3 — ~~Generator~~ Frequency and Voltage Protection Settings **for Generating Resources**

Inclusion I4, to the point where those resources aggregate to greater than 75 MVA.

4.2.1.6 ~~Collector transformer~~MPT of resource(s) identified in the BES Definition, Inclusion I4.

4.2.2 Exemptions: Protection on all auxiliary equipment within the generating Facility.

5. Effective Date: See Implementation Plan for PRC-024-3

B. Requirements and Measures

- R1.** Each Generator Owner ~~or Transmission Owner~~ shall set its applicable frequency protection³ in accordance with PRC-024 Attachment 1 such that the applicable protection does not cause the generating resource ~~does not~~ trip or ~~enter momentary cessation- cease injecting current during a frequency excursion~~ within the “no trip zone” ~~of PRC-024 Attachment 1, subject with to~~ the following exception: *[Violation Risk Factor: Medium] [Time Horizon: Long-term Planning]*
- Applicable frequency protection ~~Generating resource(s)~~ may be set to trip or ~~enter momentary cessation- cease injecting current~~ within a portion of the “no trip zone” ~~of PRC-024 Attachment 1~~ for documented and communicated regulatory or equipment limitations in accordance with Requirement R3.
- M1.** Each Generator Owner ~~or Transmission Owner~~ shall have evidence that the applicable frequency protection has been set in accordance with Requirement R1, such as dated setting sheets, calibration sheets, calculations, or other documentation.
- R2.** Each Generator Owner ~~or Transmission Owner~~ shall set its applicable voltage protection³ in accordance with PRC-024 Attachment 2, such that the applicable protection does not cause the generating resource ~~to does not~~ trip or ~~cease injecting current enter momentary cessation~~ within the “no trip zone” ~~of PRC-024 Attachment 2~~ during a voltage excursion ~~at the high side of the GSU or collector transformer/MPT,~~ subject to the following exceptions: *[Violation Risk Factor: Medium] [Time Horizon: Long-term Planning]*
- If the Transmission Planner allows less stringent voltage protection settings than those required to meet PRC-024 Attachment 2, then the Generator Owner ~~or Transmission Owner~~ may set its protection within the voltage recovery characteristics of a location-specific Transmission Planner’s study.
 - Applicable voltage protection ~~Generating resource(s)~~ may be set to trip or ~~cease injecting current during a voltage excursion enter momentary cessation~~ within a portion of the “no trip zone” ~~of PRC-024 Attachment 2~~ for documented and communicated regulatory or equipment limitations in accordance with Requirement R3.
- M2.** Each Generator Owner ~~or Transmission Owner~~ shall have evidence that applicable voltage protection has been set in accordance with Requirement R2, such as dated setting sheets, voltage-time boundaries, calibration sheets, coordination plots, dynamic simulation studies, calculations, or other documentation.

³ Frequency, voltage, and volts per hertz protection (whether provided by relaying or functions within associated control systems) that respond to electrical signals and: (i) directly trip the generating resource(s); or (ii) provide signals to the generating resource(s) to either trip or cease injecting current.

PRC-024-3 — ~~Generator~~ Frequency and Voltage Protection Settings for Generating Resources

R3. Each Generator Owner ~~or Transmission Owner~~ shall document each known regulatory or equipment limitation⁴ that prevents an applicable generating resource(s) with ~~generator~~ frequency or voltage protection from meeting the protection setting criteria in Requirements R1 or R2, including (but not limited to) study results, experience from an actual event, or manufacturer's advice. *[Violation Risk Factor: Lower] [Time Horizon: Long-term Planning]*

3.1. The Generator Owner ~~or Transmission Owner~~ shall communicate the documented regulatory or equipment limitation, or the removal of a previously documented regulatory or equipment limitation, to its Planning Coordinator and Transmission Planner within 30 calendar days of any of the following:

- Identification of a regulatory or equipment limitation.
- Repair of the equipment causing the limitation that removes the limitation.
- Replacement of the equipment causing the limitation with equipment that removes the limitation.
- Creation or adjustment of an equipment limitation caused by consumption of the cumulative turbine life-time frequency excursion allowance.

M3. Each Generator Owner ~~or Transmission Owner~~ shall have evidence that it has documented and communicated any known regulatory or equipment limitations that resulted in an exception to Requirements R1 or R2 in accordance with Requirement R3, such as a dated email or letter that contains such documentation as study results, experience from an actual event, or manufacturer's advice.

R4. Each Generator Owner ~~or Transmission Owner~~ shall provide its applicable ~~generator~~ protection settings associated with Requirements R1 and R2 to the Planning Coordinator or Transmission Planner that models the associated generating resource(s) within 60 calendar days of receipt of a written request for the data and within 60 calendar days of any change to those previously requested settings unless directed by the requesting Planning Coordinator or Transmission Planner that the reporting of protection setting changes is not required. *[Violation Risk Factor: Lower] [Time Horizon: Operations Planning]*

M4. Each Generator Owner ~~or Transmission Owner~~ shall have evidence that it communicated applicable ~~generator~~ protection settings in accordance with Requirement R4, such as dated e-mails, correspondence or other evidence and copies of any requests it has received for that information.

⁴ Excludes limitations ~~that are~~ caused by the setting capability of the ~~generator~~ frequency and voltage ~~protective relays for the generating resource(s) protection itself~~ but does not exclude limitations originating in the equipment that ~~the relays protect~~ or frequency and voltage protection imbedded in control systems.

C. Compliance

1. Compliance Monitoring Process

- 1.1. Compliance Enforcement Authority:** “Compliance Enforcement Authority” means NERC or the Regional Entity, or any entity as otherwise designated by an Applicable Governmental Authority, in their respective roles of monitoring and/or enforcing compliance with mandatory and enforceable Reliability Standards in their respective jurisdictions.
- 1.2. Evidence Retention:** The following evidence retention period(s) identify the period of time an entity is required to retain specific evidence to demonstrate compliance. For instances where the evidence retention period specified below is shorter than the time since the last audit, the Compliance Enforcement Authority may ask an entity to provide other evidence to show that it was compliant for the full-time period since the last audit.

The applicable entity shall keep data or evidence to show compliance as identified below unless directed by its Compliance Enforcement Authority to retain specific evidence for a longer period of time as part of an investigation.

- The Generator Owner ~~or Transmission Owner~~ shall keep data or evidence of Requirements R1 through R4 for 3 years or until the next audit, whichever is longer.
 - If a Generator Owner ~~or Transmission Owner~~ is found non-compliant, the Generator Owner or Transmission Owner shall keep information related to the non-compliance until mitigation is complete and approved for the time period specified above, whichever is longer.
- 1.3. Compliance Monitoring and Enforcement Program:** As defined in the NERC Rules of Procedure, “Compliance Monitoring and Enforcement Program” refers to the identification of the processes that will be used to evaluate data or information for the purpose of assessing performance or outcomes with the associated Reliability Standard.

Violation Severity Levels

R #	Violation Severity Levels			
	Lower VSL	Moderate VSL	High VSL	Severe VSL
R1.	N/A	N/A	N/A	The Generator Owner or Transmission Owner failed to set its applicable frequency protection so that it does not trip or enter momentary cessation <u>cease injecting current</u> according to Requirement R1.
R2.	N/A	N/A	N/A	The Generator Owner or Transmission Owner failed to set its applicable voltage protection so that it does not trip or <u>cease injecting current</u> enter momentary cessation according to Requirement R2.
R3.	The Generator Owner or Transmission Owner documented the known non-protection system equipment limitation that prevented it from meeting the criteria in Requirement R1 or R2 and communicated the documented limitation to its Planning Coordinator	The Generator Owner or Transmission Owner documented the known non-protection system equipment limitation that prevented it from meeting the criteria in Requirement R1 or R2 and communicated the documented limitation to its Planning Coordinator	The Generator Owner or Transmission Owner documented the known non-protection system equipment limitation that prevented it from meeting the criteria in Requirement R1 or R2 and communicated the documented limitation to its Planning Coordinator	The Generator Owner or Transmission Owner failed to document any known non-protection system equipment limitation that prevented it from meeting the criteria in Requirement R1 or R2. OR

R #	Violation Severity Levels			
	Lower VSL	Moderate VSL	High VSL	Severe VSL
	and Transmission Planner more than 30 calendar days but less than or equal to 60 calendar days of identifying the limitation.	and Transmission Planner more than 60 calendar days but less than or equal to 90 calendar days of identifying the limitation.	and Transmission Planner more than 90 calendar days but less than or equal to 120 calendar days of identifying the limitation.	The Generator Owner or Transmission Owner failed to communicate the documented limitation to its Planning Coordinator and Transmission Planner within 120 calendar days of identifying the limitation.
R4.	<p>The Generator Owner or Transmission Owner provided its generator protection settings more than 60 calendar days but less than or equal to 90 calendar days of any change to those settings.</p> <p>OR</p> <p>The Generator Owner or Transmission Owner provided generator protection settings more than 60 calendar days but less than or equal to 90 calendar days of a written request.</p>	<p>The Generator Owner or Transmission Owner provided its generator protection settings more than 90 calendar days but less than or equal to 120 calendar days of any change to those settings.</p> <p>OR</p> <p>The Generator Owner or Transmission Owner provided generator protection settings more than 90 calendar days but less than or equal to 120 calendar days of a written request.</p>	<p>The Generator Owner or Transmission Owner provided its generator protection settings more than 120 calendar days but less than or equal to 150 calendar days of any change to those settings.</p> <p>OR</p> <p>The Generator Owner or Transmission Owner provided generator protection settings more than 120 calendar days but less than or equal to 150 calendar days of a written request.</p>	<p>The Generator Owner or Transmission Owner failed to provide its generator protection settings within 150 calendar days of any change to those settings.</p> <p>OR</p> <p>The Generator Owner or Transmission Owner failed to provide generator protection settings within 150 calendar days of a written request.</p>

D. Regional Variances

D.A. Variance for the Quebec Interconnection

~~This Interconnection-wide Variance shall be applicable in the Quebec Interconnection and replaces, in its entirety, continent-wide Requirement R2 with the following:~~

This Variance extends the applicability of Requirements R1, R3, and R4 to Transmission Owners in the Quebec Interconnection that own a BES GSU or MPT and apply protection listed in Section 4.2.1, Facilities. This Variance also replaces Requirement R2 of the continent-wide standard in its entirety and adds a new requirement, Requirement D.A.2, applicable to Planning Coordinators in the Quebec Interconnection.

In Requirements R1, R3, and R4, all references to “Generator Owner” are replaced with “Generator Owner and Transmission Owner.”

This Variance replaces continent-wide Requirement R2 in its entirety with the following:

- D.A.2.** Each Generator Owner ~~or and~~ Transmission Owner shall set its applicable voltage protection³ in accordance with PRC-024 Attachment 2a, such that the applicable protection does not cause the generating resource ~~does not to~~ trip or cease injecting current ~~enter momentary cessation~~ within the “no trip zone” ~~of PRC-024 Attachment 2a~~ during a voltage excursion at the high side of the GSU or ~~collector transformer~~ MPT, subject to the following exceptions: *[Violation Risk Factor: Medium] [Time Horizon: Long-term Planning]*
- For newly designated strategic power plants, applicable protections must comply with the high voltage durations for such plants within 48 calendar months of the notification made pursuant to Requirement D.A.5. During this transition period, voltage protections must at least comply with the high voltage durations for “all power plants”.
 - The generating resource(s) are permitted to be set to trip or to cease injecting current during a voltage excursion bounded by the “no trip zone” of PRC-024 Attachment 2a for documented and communicated regulatory or equipment limitations in accordance with Requirement R3.
 - If the Transmission Planner allows less stringent voltage protection settings than those required to meet PRC-024 Attachment 2a, then the Generator Owner or Transmission Owner may set its protection within the voltage recovery characteristics of a location-specific Transmission Planner’s study.

PRC-024-3 — ~~Generator~~ Frequency and Voltage Protection Settings for Generating Resources

- ~~Generating resource(s) may trip or enter momentary cessation within a portion of the “no trip zone” of PRC-024 Attachment 2a for documented and communicated regulatory or equipment limitations in accordance with Requirement R3.~~
- Inverter-based resources voltage protection settings may be set to ~~cease injecting current momentarily enter momentary cessation within the “no trip zone” of PRC-024 Attachment 2a~~ during a voltage excursion at the high side of the MPT, bounded by the “no trip zone” of PRC-024 Attachment 2a, under the following conditions:
 - After a minimum delay of 0.022 s, when the positive-sequence voltage exceeds 1.25 per unit (p.u.) Normal operation must resume once the voltage drops back below 1.25 p.u. at the high side of the MPT.
 - After a minimum delay of 0.022 s, when the phase-to-ground root mean square (RMS) voltages exceeds 1.4 p.u., as measured at generator terminals, on one or multiple phases. Normal operation must resume once the positive-sequence voltage drops back below the 1.25 p.u. at the high side of the MPT.

M.D.A.2. Each Generator Owner ~~or and~~ Transmission Owner shall have evidence that applicable voltage protection has been set in accordance with Requirement R2, such as dated setting sheets, voltage-time boundaries, calibration sheets, coordination plots, dynamic simulation studies, calculations, or other documentation.

This Variance adds the following Requirement:

D.A.5 Each Planning Coordinator shall designate, at least once every five calendar years, the strategic power plants that must comply with Attachment 2a and notify, within 30 calendar days of its designation, each Generator Owner or Transmission Owner that owns facilities⁵ in the strategic power plants. [Violation Risk Factor: High] [Time Horizon: Long-term planning]

M.D.A.5 Each Planning Coordinator shall have evidence that it designated, at least once every five calendar years, strategic power plants in accordance with Requirement D.A.5, Part 5 and shall have dated evidence that each Generator Owner or Transmission Owner has been notified in accordance with Requirement D.A.5, part 5.2. Evidence may include, but is not limited to: letters, emails, electronic files, or hard copy records demonstrating transmittal of information.

⁵ Facilities in the strategic power plants include facilities from the generator up to and including the MPT or GSU.

Violation Severity Levels

This Variance adds a VSL for D.A.5. and modifies the VSL for R2 as follows:

<u>R.#</u>	<u>Violation Severity Levels</u>			
	<u>Lower VSL</u>	<u>Moderate VSL</u>	<u>High VSL</u>	<u>Severe VSL</u>
<u>D.A.2.</u>	<u>N/A</u>	<u>N/A</u>	<u>N/A</u>	<p><u>The Generator Owner or Transmission Owner failed to set its applicable voltage protection so that it does not trip or cease injecting current in accordance with Requirement D.A.2.</u></p> <p><u>OR</u></p> <p><u>The Generator Owner or Transmission Owner set its applicable voltage protection in accordance with Requirement D.A.2 but, for strategic power plants, failed to do so within 48 months of notification.</u></p>
<u>D.A.5.</u>	<u>N/A</u>	<u>The Planning Coordinator designated strategic power plants at least once every five calendar years but notified each Generator Owner or</u>	<u>The Planning Coordinator designated strategic power plants at least once every five calendar years but notified each Generator Owner or</u>	<u>The Planning Coordinator failed to designate, at least once every five years, the strategic</u>

<u>R.#</u>	<u>Violation Severity Levels</u>			
	<u>Lower VSL</u>	<u>Moderate VSL</u>	<u>High VSL</u>	<u>Severe VSL</u>
		<u>Transmission Owner that owns facilities in the strategic power plants between 31 days and 45 days after its designation.</u>	<u>Transmission Owner that owns facilities in the strategic power plants between 46 days and 60 days after its designation.</u>	<u>power plants that must comply with Attachment 2a.</u> <u>OR</u> <u>The Planning Coordinator failed to notify, each Generator Owner or Transmission Owner that owns facilities in the strategic power plants or notified them more than 60 days after the its designation.</u>

E. Associated Documents

Implementation Plan

~~Industry Recommendation I — Loss of Solar Resources during Transmission Disturbances Due to Inverter Settings~~

~~Industry Recommendation II — Loss of Solar Resources during Transmission Disturbances due to Inverter Settings~~

~~Blue Cut Fire Disturbance~~

~~Canyon 2 Fire Disturbance~~

~~“Protective Relaying For Power Generation Systems”, Boca Raton, FL, Taylor & Francis, 2006, Reimert, Donald~~

~~“IEEE C37.102 IEEE Guide for AC Generator Protection”~~

~~“IEEE C50.13 IEEE Standard for Cylindrical Rotor 50 Hz and 60 Hz Synchronous Generators Rated 10 MVA and Above”~~

~~“IEEE C37.106 IEEE Guide for Abnormal Frequency Protection for Power Generating Plants”~~

Version History

Version	Date	Action	Change Tracking
1	May 9, 2013	Adopted by the NERC Board of Trustees	
1	March 20, 2014	FERC Order issued approving PRC-024-1. (Order becomes effective on 7/1/16.)	
2	February 12, 2015	Adopted by the NERC Board of Trustees	Standard revised in Project 2014-01: Applicability revised to clarify application of requirements to BES dispersed power producing resources
2	May 29, 2015	FERC Letter Order in Docket No. RD15-3-000 approving PRC-024-2	Modifications to adjust the applicability to owners of dispersed generation resources.

Attachment 1
 (Frequency No Trip ~~Boundary~~ Boundaries by Interconnection⁶)

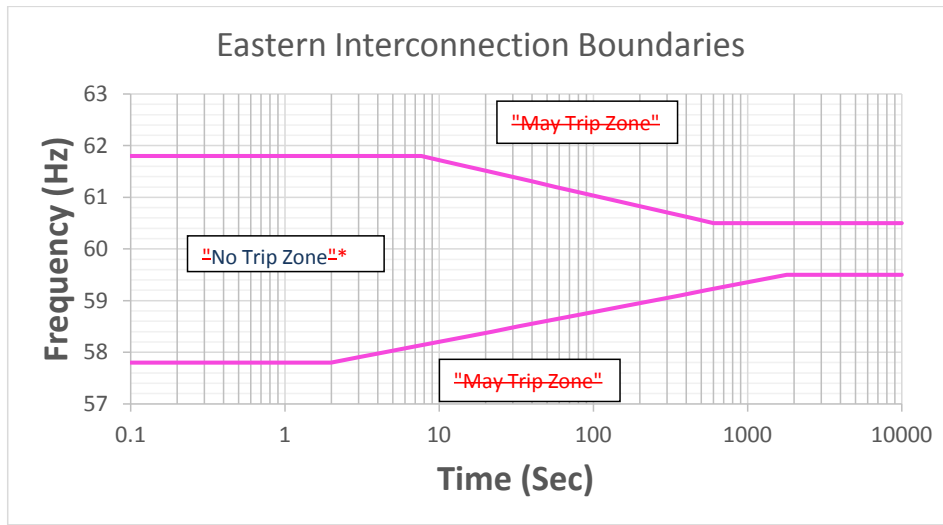

Figure 1

** The area outside the "No Trip Zone" is not a "Must Trip Zone."*

Frequency Boundary Data Points – Eastern Interconnection

High Frequency Duration		Low Frequency Duration	
Frequency (Hz)	Minimum Time (Sec)	Frequency (Hz)	Minimum Time (sec)
≥61.8	Instantaneous⁷0-10	≤57.8	Instantaneous⁷0-10
≥60.5	$10^{(90.935-1.45713*f)}$	≤59.5	$10^{(1.7373*f-100.116)}$
<60.5	Continuous operation	> 59.5	Continuous operation

Table 1

⁶ The figures do not visually represent the "no trip zone" boundaries before 0.1 seconds and after 10,000 seconds. The Frequency Boundary Data Points Table defines the entirety of the "no trip zone" boundaries.

⁷ Frequency is calculated over a window of time. While the frequency boundaries include the option to trip instantaneously for frequencies outside the specified range, this calculation should occur over a time window. Typical window/filtering lengths are three to six cycles (50 – 100 milliseconds). Instantaneous trip settings based on instantaneously calculated frequency measurement is not permissible.

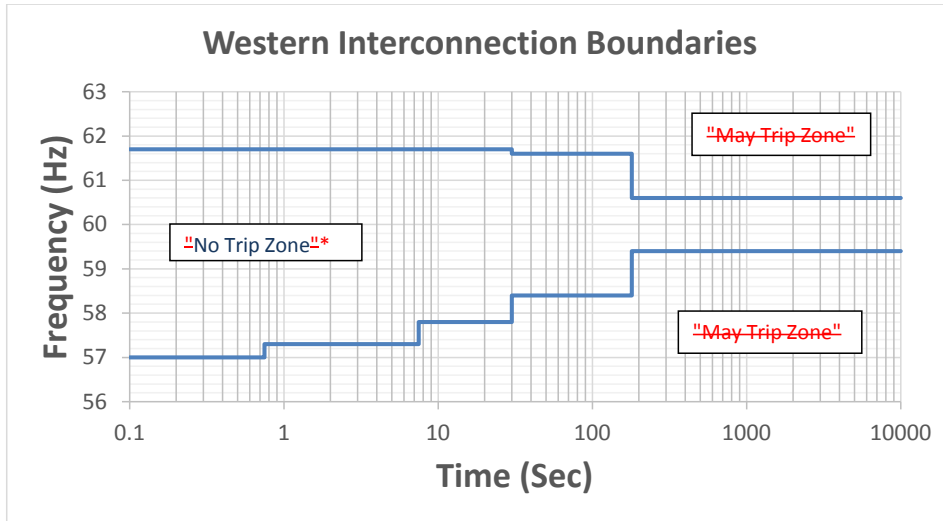

Figure 2

* The area outside the "No Trip Zone" is not a "Must Trip Zone."

Frequency Boundary Data Points – Western Interconnection

High Frequency Duration		Low Frequency Duration	
Frequency (Hz)	Minimum Time (Sec)	Frequency (Hz)	Minimum Time (sec)
≥61.7	<u>Instantaneous^{0.10}</u>	≤57.0	<u>Instantaneous^{0.10}</u>
≥61.6	30	≤57.3	0.75
≥60.6	180	≤57.8	7.5
<60.6	Continuous operation	≤58.4	30
		≤59.4	180
		>59.4	Continuous operation

Table 2

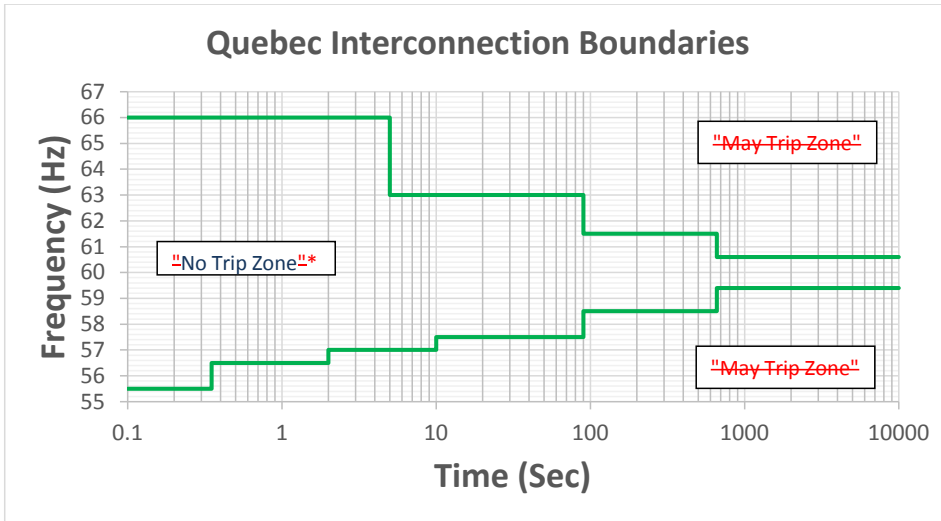

Figure 3

* The area outside the "No Trip Zone" is not a "Must Trip Zone."

Frequency Boundary Data Points – Quebec Interconnection

High Frequency Duration		Low Frequency Duration	
Frequency (Hz)	Minimum Time (Sec)	Frequency (Hz)	Minimum Time (Sec)
>66.0	<u>Instantaneous^{0.10}</u>	<55.5	<u>Instantaneous^{0.10}</u>
≥63.0	5	≤56.5	0.35
≥61.5	90	≤57.0	2
≥60.6	660	≤57.5	10
<60.6	Continuous operation	≤58.5	90
		≤59.4	660
		>59.4	Continuous operation

Table 3

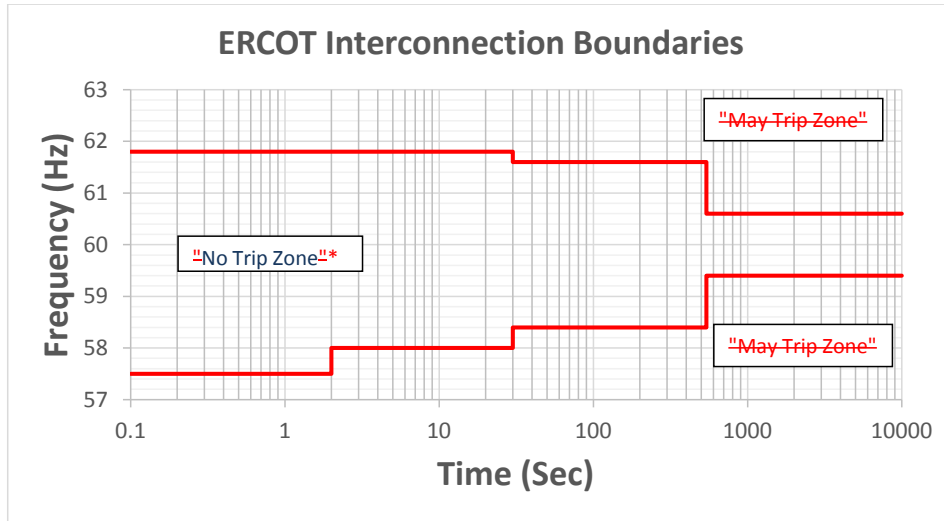

Figure 4

* The area outside the "No Trip Zone" is not a "Must Trip Zone."

Frequency Boundary Data Points – ERCOT Interconnection

High Frequency Duration		Low Frequency Duration	
Frequency (Hz)	Minimum Time (Sec)	Frequency (Hz)	Minimum Time (sec)
≥61.8	Instantaneous ^{0.10}	≤57.5	Instantaneous ^{0.10}
≥61.6	30	≤58.0	2
≥60.6	540	≤58.4	30
<60.6	Continuous operation	≤59.4	540
		>59.4	Continuous operation

Table 4

PRC-024_— Attachment 2
 (Voltage No-Trip ~~Boundaries Boundary~~— Eastern, Western, and ERCOT Interconnections)

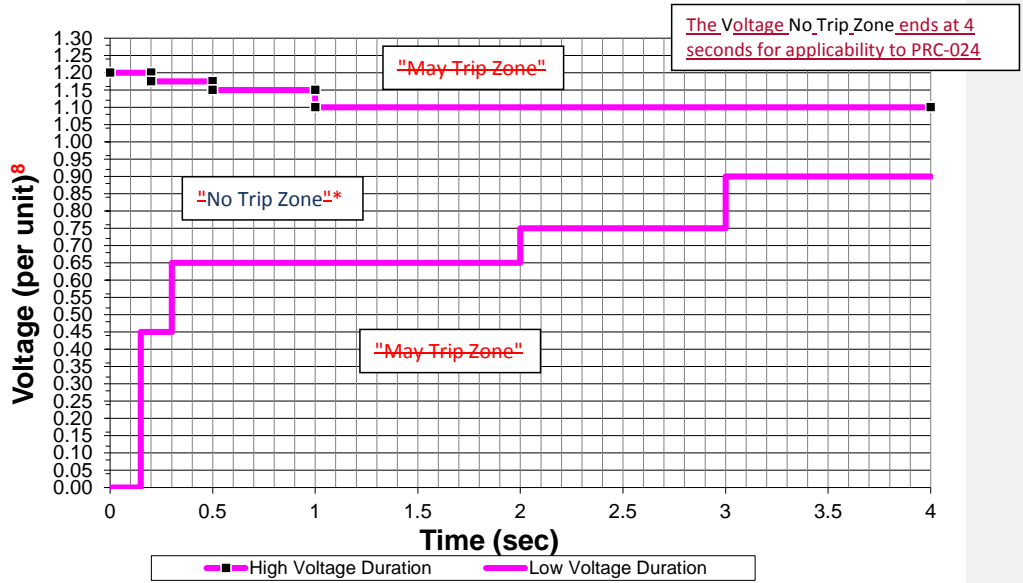

Figure 1

Voltage Boundary Data Points

High Voltage Duration		Low Voltage Duration	
Voltage (pu)	Minimum Time (sec)	Voltage (pu)	Minimum Time (sec)
≥1.200	0.00	<0.45	0.15
≥1.175	0.20	<0.65	0.30
≥1.15	0.50	<0.75	2.00
≥1.10	1.00	<0.90	3.00
<1.10	4.00	≥ 0.90	4.00

Table 1

⁷Voltage-⁸Voltage at the high-side of the GSU or collector transformer MPT.

Attachment 2: Voltage Boundary Clarifications – Eastern, Western, and ERCOT Interconnections

Boundary Details:

1. ~~Unless otherwise specified by the Transmission Planner, the~~ The per unit voltage base for these boundaries is the nominal ~~transmission system operating~~ voltage (e.g., ~~100 kV, 115-kV, 138 kV, 161 kV, 230 kV, 345 kV, 400 kV, 500 kV, 765 kV,~~ etc.).
- ~~2. The boundaries apply to voltage excursions regardless of the type of initiating event.~~
- ~~3.2.~~ The values in the table represent the minimum time durations allowed for specified voltage excursion thresholds.
- ~~4.3.~~ The boundaries assume a system frequency of 60 Hertz. When evaluating volts per hertz protection, ~~either assume a system frequency of 60 Hertz or the~~ magnitude of the high voltage boundary can be adjusted in proportion to deviations of frequency below 60 Hertz.
- ~~5.4.~~ Voltages in the boundaries assume RMS fundamental frequency phase-to-ground or phase-to-phase ~~per unit~~ voltage.
- ~~6.5.~~ For applicability to PRC-024, the ~~The~~ “no trip zone” ends at 4 seconds.

Evaluating Protection Settings:

~~The voltage values in the Attachment 2 voltage boundaries are voltages at the high side of the GSU/MPT. For generating resources with multiple stages of step up to reach interconnecting voltage, this is the high side of the transformer with a low side below 100 kV and a high side 100kV or above. When evaluating protection settings, consider the voltage differences between where the protection is measuring voltage and the high side of the GSU/MPT. A steady state calculation or dynamic simulation may be used.~~

~~If using a steady state calculation or dynamic simulation, use the following conditions when evaluating protection settings:~~

- ~~a. The most probable real and reactive loading conditions for the unit under study.~~
 - ~~b. All installed generating plant reactive support (e.g., static VAR compensators, synchronous condensers, capacitors) equipment is available and operating normally.~~
 - ~~c. Account for the actual tap settings of transformers between the generator terminals and the high side of the GSU/MPT.~~
 - ~~d. For dynamic simulations, the automatic voltage regulator is in automatic voltage control mode with associated limiters in service.~~
1. Use either the following assumptions or loading conditions that are believed to be the most probable for the unit under study to evaluate voltage protection setting calculations on the static case for steady state initial conditions:

- ~~a.—All of the units connected to the same transformer are online and operating.~~
 - ~~b.—All of the units are at full nameplate real power output.~~
 - ~~c.—Power factor is 0.95 lagging (i.e. supplying reactive power to the system) as measured at the generator terminals.~~
 - ~~d.—The automatic voltage regulator is in automatic voltage control mode.~~
- ~~2.—Evaluate voltage protection settings assuming that additional installed generating plant reactive support equipment (such as static VAR compensators, synchronous condensers, or capacitors) is available and operating normally.~~
- ~~3.—Evaluate voltage protection settings accounting for the actual tap settings of transformers between the generator terminals and the high side of the GSU or collector transformer.~~

PRC-024— Attachment 2a (Voltage No-Trip Boundaries – Quebec Interconnection)

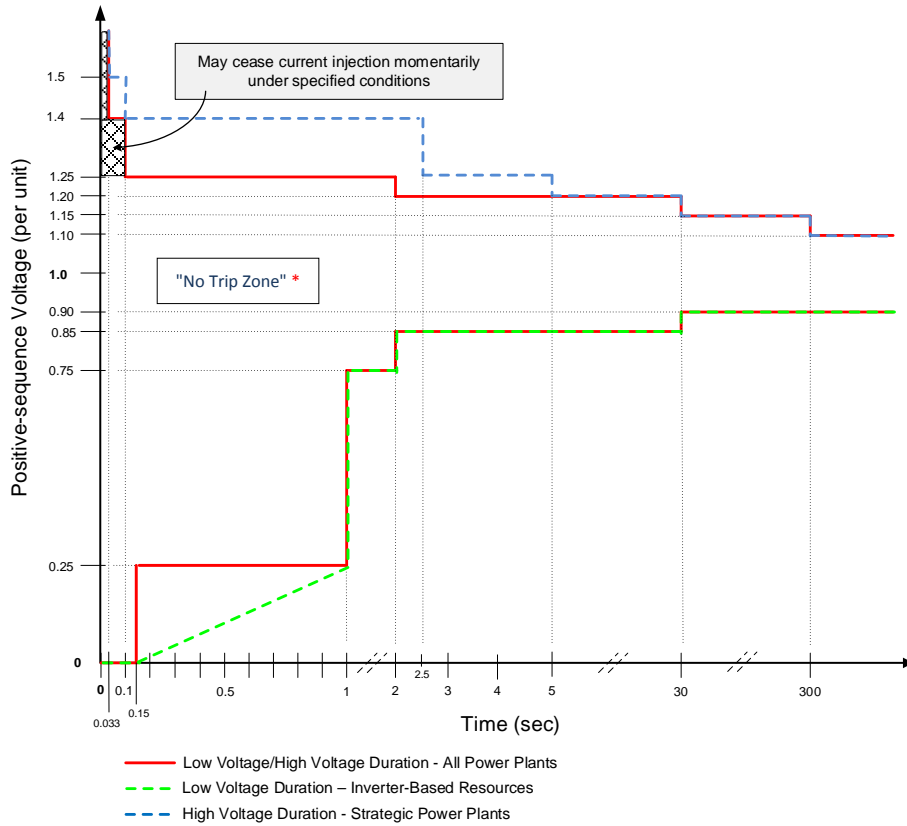

Field Code Changed

Figure 1

** The area outside the "No Trip Zone" is not a "Must Trip Zone"*

Voltage Boundary Data Points – Quebec Interconnection

High Voltage Duration for all Power Plants		High Voltage Duration for strategic ⁺ Power Plants	
Voltage (pu)	Minimum Time (sec)	Voltage (pu)	Minimum Time (sec)
---	---	>1.50	0.033
>1.40	0.033	>1.40	0.10
>1.25	0.10	>1.25	2.50
>1.20	2.00	>1.20	5.00
>1.15	30	>1.15	30
>1.10	300	>1.10	300
≤1.10	continuous	≤1.10	continuous

Table 1

Voltage Boundary Data Points – Quebec Interconnection

Low Voltage Duration for all Power Plants		Low Voltage Duration for Inverter-Based Resources	
Voltage (pu)	Minimum Time (sec)	Voltage (pu)	Minimum Time (sec)
<0.25	0.15	<0.25	$3.4 * V(\text{pu}) + 0.15$
<0.75	1.00	<0.75	1.00
<0.85	2.00	<0.85	2.00
<0.90	30	<0.90	30
≥0.90	continuous	≥0.90	continuous

Table 2

⁺Power Plants designated by the Transmission Planner for protecting the integrity of Transmission System equipment.

Attachment 2a: Voltage Boundary Clarifications – Quebec Interconnection

Boundary Details:

1. The per unit voltage base for these boundaries is the nominal operating voltage (e.g., 120-115 kV, 138-161 kV, 230 kV, 345-315 kV, 500-735 kV, etc.).
- ~~2. The boundaries apply to voltage excursions regardless of the type of initiating event.~~
- ~~3.2.~~ The values in the table represent the minimum time durations allowed for specified voltage excursion thresholds.
- ~~4.3.~~ The boundaries assume a system frequency of 60 Hertz. When evaluating volts per hertz protection, either assume a system frequency of 60 Hertz or the magnitude of the high voltage boundary can be adjusted in proportion to deviations of frequency below 60 Hertz.
- ~~5.4.~~ Voltages in the Quebec Interconnection boundaries assume positive-sequence values.

Evaluating Protection Settings:

- ~~1. Use either the following assumptions or loading conditions that are believed to be the most probable for the unit under study to evaluate voltage protection setting calculations on the static case for steady state initial conditions:
 - ~~a. All of the units connected to the same transformer are online and operating.~~
 - ~~b. All of the units are at full nameplate real power output.~~
 - ~~c. Power factor is 0.95 lagging (i.e. supplying reactive power to the system) as measured at the generator terminals.~~
 - ~~d. The automatic voltage regulator is in automatic voltage control mode.~~~~
- ~~2. Evaluate voltage protection settings assuming that additional installed generating plant reactive support equipment (such as static VAR compensators, synchronous condensers, or capacitors) is available and operating normally.~~
- ~~3. Evaluate voltage protection settings accounting for the actual tap settings of transformers between the generator terminals and the high side of the GSU or collector transformer.~~

The voltage values in the Attachment 2a voltage boundaries are voltages at the high side of the GSU/MPT. For generating resources with multiple stages of step up to reach interconnecting voltage, this is the high side of the transformer that connects to the interconnecting voltage. When evaluating protection settings, consider the voltage differences between where the protection is measuring voltage and the high side of the GSU/MPT. A steady state calculation or dynamic simulation may be used.

Formatted: Space After: 0 pt, Don't adjust space between Latin and Asian text, Don't adjust space between Asian text and numbers

If using a steady state calculation or dynamic simulation, use the following conditions when evaluating protection settings:

- a. The most probable real and reactive loading conditions for the unit under study.
- b. All installed generating plant reactive support (e.g., static VAR compensators, synchronous condensers, capacitors) equipment is available and operating normally.
- c. Account for the actual tap settings of transformers between the generator terminals and the high side of the GSU/MPT.
- d. For dynamic simulations, the automatic voltage regulator is in automatic voltage control mode with associated limiters in service.

Violation Risk Factor and Violation Severity Level Justifications

Project 2018-04 Modifications to PRC-024-2 September 2019

This document provides the standard drafting team's (SDT's) justification for assignment of violation risk factors (VRFs) and violation severity levels (VSLs) for each requirement in Reliability Standard PRC-024-3. Each requirement is assigned a VRF and a VSL. These elements support the determination of an initial value range for the Base Penalty Amount regarding violations of requirements in FERC-approved Reliability Standards, as defined in the Electric Reliability Organizations (ERO) Sanction Guidelines. The SDT applied the following NERC criteria and FERC Guidelines when developing the VRFs and VSLs for the requirements.

NERC Criteria for Violation Risk Factors

High Risk Requirement

A requirement that, if violated, could directly cause or contribute to Bulk Electric System instability, separation, or a cascading sequence of failures, or could place the Bulk Electric System at an unacceptable risk of instability, separation, or cascading failures; or, a requirement in a planning time frame that, if violated, could, under emergency, abnormal, or restorative conditions anticipated by the preparations, directly cause or contribute to Bulk Electric System instability, separation, or a cascading sequence of failures, or could place the Bulk Electric System at an unacceptable risk of instability, separation, or cascading failures, or could hinder restoration to a normal condition.

Medium Risk Requirement

A requirement that, if violated, could directly affect the electrical state or the capability of the Bulk Electric System, or the ability to effectively monitor and control the Bulk Electric System. However, violation of a medium risk requirement is unlikely to lead to Bulk Electric System instability, separation, or cascading failures; or, a requirement in a planning time frame that, if violated, could, under emergency, abnormal, or restorative conditions anticipated by the preparations, directly and adversely affect the electrical state or capability of the Bulk Electric System, or the ability to effectively monitor, control, or restore the Bulk Electric System. However, violation of a medium risk requirement is unlikely, under emergency, abnormal, or restoration conditions anticipated by the preparations, to lead to Bulk Electric System instability, separation, or cascading failures, nor to hinder restoration to a normal condition.

Lower Risk Requirement

A requirement that is administrative in nature and a requirement that, if violated, would not be expected to adversely affect the electrical state or capability of the Bulk Electric System, or the ability to effectively monitor and control the Bulk Electric System; or, a requirement that is administrative in nature and a requirement in a planning time frame that, if violated, would not, under the emergency, abnormal, or restorative conditions anticipated by the preparations, be expected to adversely affect the electrical state or capability of the Bulk Electric System, or the ability to effectively monitor, control, or restore the Bulk Electric System.

FERC Guidelines for Violation Risk Factors

Guideline (1) – Consistency with the Conclusions of the Final Blackout Report

FERC seeks to ensure that VRFs assigned to Requirements of Reliability Standards in these identified areas appropriately reflect their historical critical impact on the reliability of the Bulk-Power System. In the VSL Order, FERC listed critical areas (from the Final Blackout Report) where violations could severely affect the reliability of the Bulk-Power System:

- Emergency operations
- Vegetation management
- Operator personnel training
- Protection systems and their coordination
- Operating tools and backup facilities
- Reactive power and voltage control
- System modeling and data exchange
- Communication protocol and facilities
- Requirements to determine equipment ratings
- Synchronized data recorders
- Clearer criteria for operationally critical facilities
- Appropriate use of transmission loading relief.

Guideline (2) – Consistency within a Reliability Standard

FERC expects a rational connection between the sub-Requirement VRF assignments and the main Requirement VRF assignment.

Guideline (3) – Consistency among Reliability Standards

FERC expects the assignment of VRFs corresponding to Requirements that address similar reliability goals in different Reliability Standards would be treated comparably.

Guideline (4) – Consistency with NERC’s Definition of the Violation Risk Factor Level

Guideline (4) was developed to evaluate whether the assignment of a particular VRF level conforms to NERC’s definition of that risk level.

Guideline (5) – Treatment of Requirements that Co-mingle More Than One Obligation

Where a single Requirement co-mingles a higher risk reliability objective and a lesser risk reliability objective, the VRF assignment for such Requirements must not be watered down to reflect the lower risk level associated with the less important objective of the Reliability Standard.

NERC Criteria for Violation Severity Levels

VSLs define the degree to which compliance with a requirement was not achieved. Each requirement must have at least one VSL. While it is preferable to have four VSLs for each requirement, some requirements do not have multiple “degrees” of noncompliant performance and may have only one, two, or three VSLs.

VSLs should be based on NERC’s overarching criteria shown in the table below:

Lower VSL	Moderate VSL	High VSL	Severe VSL
The performance or product measured almost meets the full intent of the requirement.	The performance or product measured meets the majority of the intent of the requirement.	The performance or product measured does not meet the majority of the intent of the requirement, but does meet some of the intent.	The performance or product measured does not substantively meet the intent of the requirement.

FERC Order of Violation Severity Levels

The FERC VSL guidelines are presented below, followed by an analysis of whether the VSLs proposed for each requirement in the standard meet the FERC Guidelines for assessing VSLs:

Guideline (1) – Violation Severity Level Assignments Should Not Have the Unintended Consequence of Lowering the Current Level of Compliance

Compare the VSLs to any prior levels of non-compliance and avoid significant changes that may encourage a lower level of compliance than was required when levels of non-compliance were used.

Guideline (2) – Violation Severity Level Assignments Should Ensure Uniformity and Consistency in the Determination of Penalties

A violation of a “binary” type requirement must be a “Severe” VSL.

Do not use ambiguous terms such as “minor” and “significant” to describe noncompliant performance.

Guideline (3) – Violation Severity Level Assignment Should Be Consistent with the Corresponding Requirement

VSLs should not expand on what is required in the requirement.

Guideline (4) – Violation Severity Level Assignment Should Be Based on a Single Violation, Not on a Cumulative Number of Violations

Unless otherwise stated in the requirement, each instance of non-compliance with a requirement is a separate violation. Section 4 of the Sanction Guidelines states that assessing penalties on a per violation per day basis is the “default” for penalty calculations.

Justification for PRC-024-3 VRFs and VSLs

VRF Justification for PRC-024-3, Requirement R1

The VRF did not change from the previously FERC-approved PRC-024-2 Reliability Standard.

VSL Justification for PRC-024-3, Requirement R1

The SDT only made changes to conform the Requirement R1 VSL to the revised Requirement R1 language. The SDT retained the binary structure of the VSL, which is consistent with both the PRC-024-2 and PRC-024-1 VSLs. As a result, the [justification](#) for the Commission-approved PRC-024-1 Requirement R1 VSL supports the justification for the proposed PRC-024-3, Requirement R1 VSL.

VRF Justification for PRC-024-3, Requirement R2

The VRF did not change from the previously FERC-approved PRC-024-2 Reliability Standard.

VSL Justification for PRC-024-3, Requirement R2

The SDT only made changes to conform the Requirement R2 VSL to the revised Requirement R2 language. The SDT retained the binary structure of the VSL, which is consistent with both the PRC-024-2 and PRC-024-1 VSLs. As a result, the [justification](#) for the Commission-approved PRC-024-1 Requirement R2 VSL supports the justification for the proposed PRC-024-3, Requirement R2 VSL.

VRF Justification for PRC-024-3, Requirement R3

The VRF did not change from the previously FERC-approved PRC-024-2 Reliability Standard.

VSL Justification for PRC-024-3, Requirement R3

The SDT only revised the Requirement R4 VSL to remove the word “generator” to encompass all protection as defined in Section 4.2, Facilities. The SDT retained the existing levels of the VSLs, which is consistent with both the PRC-024-2 and PRC-024-1 VSLs. As a result, the [justification](#) for the Commission-approved PRC-024-1 Requirement R3 VSL supports the justification for the proposed PRC-024-3, Requirement R3 VSL.

VRF Justification for PRC-024-3, Requirement R4

The VRF did not change from the previously FERC-approved PRC-024-2 Reliability Standard.

VSL Justification for PRC-024-3, Requirement R4

The SDT only revised the Requirement R4 VSL to remove the word “generator” to encompass all protection as defined in Section 4.2, Facilities. The SDT retained the existing levels of the VSLs, which is consistent with both the PRC-024-2 and PRC-024-1 VSLs. As a result, the

[justification](#) for the Commission-approved PRC-024-1 Requirement R4 VSL supports the justification for the proposed PRC-024-3, Requirement R4 VSL.

VRF Justification for PRC-024-3, Requirement D.A.2.

The SDT made changes to conform the Requirement D.A.2. VSL to the revised Requirement 2 language with the addition of different no trip voltage boundaries based on power plant type as designated by the Planning Coordinator.

VSL Justification for PRC-024-3, Requirement D.A.2.

The SDT only made changes to conform Requirement D.A.2. with the Requirement R2 VSL as well as to add that newly designated strategic power plants have no less than 48 months to set their protection in accordance with the strategic power plant voltage boundaries in Attachment 2a. The SDT retained the binary structure of the VSL, which is consistent with both the PRC-024-2 and PRC-024-1 VSLs. As a result, the [justification](#) for the Commission-approved PRC-024-1 Requirement R2 VSL supports the justification for the proposed PRC-024-3, Requirement D.A.2. VSL.

VRF Justification for PRC-024-3, Requirement D.A.5.

The VRF for Requirement D.A.5. is Medium, given that is unlikely to lead to Bulk Electric System instability, separation, or cascading failures if violated. This is consistent with Requirements R1, R2, and D.A.2.

VSL Justification for PRC-024-3, Requirement D.A.5.

Proposed VSL's incorporate the increments for tardiness methodology. Proposed VSL language does not include ambiguous terms and ensure uniformity and consistency in the determination of penalties based on timeliness of the action specified. Proposed VSL's are based on a single violation and not a cumulative violation methodology.

Implementation Plan

Project 2018-04 Modifications to PRC-024-2 Reliability Standard PRC-024-3

Applicable Standard

- Reliability Standard PRC-024-3 – Frequency and Voltage Protection Settings for Generating Resources

Requested Retirement

- Reliability Standard PRC-024-2 – Generator Frequency and Voltage Protective Relay Settings

Prerequisite Standard(s)

- None

Applicable Entities

- Generator Owners that apply protection listed in Section 4.2.1.
- Transmission Owners (in the Quebec Interconnection only) that own a BES generator step-up (GSU) transformer or main power transformer (MPT) and apply protection listed in Section 4.2.1.
- Planning Coordinators (in the Quebec Interconnection only)

Background

Reliability Standard PRC-024-3 contains a series of revisions and clarifications intended to help ensure that inverter-based resources respond to grid disturbances in a manner that contributes to the reliable operation of the Bulk-Power System.

The standard was revised to address recommendations of the NERC Inverter-Based Resource Performance Task Force. These recommendations were developed in response to the findings and recommendations of the NERC and WECC analysis of the [Blue Cut Fire](#) and [Canyon 2 Fire](#) disturbances in southern California.

In addition, the standard includes a Regional Variance for the Quebec Interconnection and related revisions to clarify the applicability of the standard in that Interconnection.

General Considerations

This Implementation Plan is intended to provide applicable entities with sufficient time to evaluate settings, make changes for applicable equipment, and purchase necessary equipment, if necessary.

Setting changes and equipment installations are typically completed during generating Facility outages, which may be scheduled in up to twenty-four (24) month intervals.

Effective Date

Reliability Standard PRC-024-3

Where approval by an applicable governmental authority is required, the standard shall become effective on the first day of the first calendar quarter that is twenty-four (24) months after the effective date of the applicable governmental authority's order approving the standard, or as otherwise provided for by the applicable governmental authority.

Where approval by an applicable governmental authority is not required, the standard shall become effective on the first day of the first calendar quarter that is twenty-four (24) months after the date the standard is adopted by the NERC Board of Trustees, or as otherwise provided for in that jurisdiction.

Retirement Date

Reliability Standard PRC-024-2

Reliability Standard PRC-024-2 shall be retired immediately prior to the effective date of Reliability Standard PRC-024-3 in the particular jurisdiction in which the revised standard is becoming effective.

Violation Risk Factor and Violation Severity Level Justifications

Project 2018-04 Modifications to PRC-024-2 ~~April~~ September 2019

This document provides the standard drafting team's (SDT's) justification for assignment of violation risk factors (VRFs) and violation severity levels (VSLs) for each requirement in Reliability Standard PRC-024-3. Each requirement is assigned a VRF and a VSL. These elements support the determination of an initial value range for the Base Penalty Amount regarding violations of requirements in FERC-approved Reliability Standards, as defined in the Electric Reliability Organizations (ERO) Sanction Guidelines. The SDT applied the following NERC criteria and FERC Guidelines when developing the VRFs and VSLs for the requirements.

NERC Criteria for Violation Risk Factors

High Risk Requirement

A requirement that, if violated, could directly cause or contribute to Bulk Electric System instability, separation, or a cascading sequence of failures, or could place the Bulk Electric System at an unacceptable risk of instability, separation, or cascading failures; or, a requirement in a planning time frame that, if violated, could, under emergency, abnormal, or restorative conditions anticipated by the preparations, directly cause or contribute to Bulk Electric System instability, separation, or a cascading sequence of failures, or could place the Bulk Electric System at an unacceptable risk of instability, separation, or cascading failures, or could hinder restoration to a normal condition.

Medium Risk Requirement

A requirement that, if violated, could directly affect the electrical state or the capability of the Bulk Electric System, or the ability to effectively monitor and control the Bulk Electric System. However, violation of a medium risk requirement is unlikely to lead to Bulk Electric System instability, separation, or cascading failures; or, a requirement in a planning time frame that, if violated, could, under emergency, abnormal, or restorative conditions anticipated by the preparations, directly and adversely affect the electrical state or capability of the Bulk Electric System, or the ability to effectively monitor, control, or restore the Bulk Electric System. However, violation of a medium risk requirement is unlikely, under emergency, abnormal, or restoration conditions anticipated by the preparations, to lead to Bulk Electric System instability, separation, or cascading failures, nor to hinder restoration to a normal condition.

Lower Risk Requirement

A requirement that is administrative in nature and a requirement that, if violated, would not be expected to adversely affect the electrical state or capability of the Bulk Electric System, or the ability to effectively monitor and control the Bulk Electric System; or, a requirement that is administrative in nature and a requirement in a planning time frame that, if violated, would not, under the emergency, abnormal, or restorative conditions anticipated by the preparations, be expected to adversely affect the electrical state or capability of the Bulk Electric System, or the ability to effectively monitor, control, or restore the Bulk Electric System.

FERC Guidelines for Violation Risk Factors

Guideline (1) – Consistency with the Conclusions of the Final Blackout Report

FERC seeks to ensure that VRFs assigned to Requirements of Reliability Standards in these identified areas appropriately reflect their historical critical impact on the reliability of the Bulk-Power System. In the VSL Order, FERC listed critical areas (from the Final Blackout Report) where violations could severely affect the reliability of the Bulk-Power System:

- Emergency operations
- Vegetation management
- Operator personnel training
- Protection systems and their coordination
- Operating tools and backup facilities
- Reactive power and voltage control
- System modeling and data exchange
- Communication protocol and facilities
- Requirements to determine equipment ratings
- Synchronized data recorders
- Clearer criteria for operationally critical facilities
- Appropriate use of transmission loading relief.

Guideline (2) – Consistency within a Reliability Standard

FERC expects a rational connection between the sub-Requirement VRF assignments and the main Requirement VRF assignment.

Guideline (3) – Consistency among Reliability Standards

FERC expects the assignment of VRFs corresponding to Requirements that address similar reliability goals in different Reliability Standards would be treated comparably.

Guideline (4) – Consistency with NERC’s Definition of the Violation Risk Factor Level

Guideline (4) was developed to evaluate whether the assignment of a particular VRF level conforms to NERC’s definition of that risk level.

Guideline (5) – Treatment of Requirements that Co-mingle More Than One Obligation

Where a single Requirement co-mingles a higher risk reliability objective and a lesser risk reliability objective, the VRF assignment for such Requirements must not be watered down to reflect the lower risk level associated with the less important objective of the Reliability Standard.

NERC Criteria for Violation Severity Levels

VSLs define the degree to which compliance with a requirement was not achieved. Each requirement must have at least one VSL. While it is preferable to have four VSLs for each requirement, some requirements do not have multiple “degrees” of noncompliant performance and may have only one, two, or three VSLs.

VSLs should be based on NERC’s overarching criteria shown in the table below:

Lower VSL	Moderate VSL	High VSL	Severe VSL
The performance or product measured almost meets the full intent of the requirement.	The performance or product measured meets the majority of the intent of the requirement.	The performance or product measured does not meet the majority of the intent of the requirement, but does meet some of the intent.	The performance or product measured does not substantively meet the intent of the requirement.

FERC Order of Violation Severity Levels

The FERC VSL guidelines are presented below, followed by an analysis of whether the VSLs proposed for each requirement in the standard meet the FERC Guidelines for assessing VSLs:

Guideline (1) – Violation Severity Level Assignments Should Not Have the Unintended Consequence of Lowering the Current Level of Compliance

Compare the VSLs to any prior levels of non-compliance and avoid significant changes that may encourage a lower level of compliance than was required when levels of non-compliance were used.

Guideline (2) – Violation Severity Level Assignments Should Ensure Uniformity and Consistency in the Determination of Penalties

A violation of a “binary” type requirement must be a “Severe” VSL.

Do not use ambiguous terms such as “minor” and “significant” to describe noncompliant performance.

Guideline (3) – Violation Severity Level Assignment Should Be Consistent with the Corresponding Requirement

VSLs should not expand on what is required in the requirement.

Guideline (4) – Violation Severity Level Assignment Should Be Based on a Single Violation, Not on a Cumulative Number of Violations

Unless otherwise stated in the requirement, each instance of non-compliance with a requirement is a separate violation. Section 4 of the Sanction Guidelines states that assessing penalties on a per violation per day basis is the “default” for penalty calculations.

Justification for PRC-024-3 VRFs and VSLs

VRF Justification for PRC-024-3, Requirement R1

The VRF did not change from the previously FERC-approved PRC-024-2 Reliability Standard.

VSL Justification for PRC-024-3, Requirement R1

The SDT only made changes to conform the Requirement R1 VSL to the revised Requirement R1 language. The SDT retained the binary structure of the VSL, which is consistent with both the PRC-024-2 and PRC-024-1 VSLs. As a result, the [justification](#) for the Commission-approved PRC-024-1 Requirement R1 VSL supports the justification for the proposed PRC-024-3, Requirement R1 VSL.

VRF Justification for PRC-024-3, Requirement R2

The VRF did not change from the previously FERC-approved PRC-024-2 Reliability Standard.

VSL Justification for PRC-024-3, Requirement R2

The SDT only made changes to conform the Requirement R2 VSL to the revised Requirement R2 language. The SDT retained the binary structure of the VSL, which is consistent with both the PRC-024-2 and PRC-024-1 VSLs. As a result, the [justification](#) for the Commission-approved PRC-024-1 Requirement R2 VSL supports the justification for the proposed PRC-024-3, Requirement R2 VSL.

VRF Justification for PRC-024-3, Requirement R3

The VRF did not change from the previously FERC-approved PRC-024-2 Reliability Standard.

VSL Justification for PRC-024-3, Requirement R3

The SDT only revised the Requirement R3 VSL to add Transmission Owner. The SDT only revised the Requirement R4 VSL to remove the word “generator” to encompass all protection as defined in Section 4.2, Facilities. -The SDT retained the existing levels of the VSLs, which is consistent with both the PRC-024-2 and PRC-024-1 VSLs. As a result, the [justification](#) for the Commission-approved PRC-024-1 Requirement R3 VSL supports the justification for the proposed PRC-024-3, Requirement R3 VSL.

VRF Justification for PRC-024-3, Requirement R4

The VRF did not change from the previously FERC-approved PRC-024-2 Reliability Standard.

VSL Justification for PRC-024-3, Requirement R4

The SDT only revised the Requirement R4 VSL to remove the word “generator” to encompass all protection as defined in Section 4.2, Facilities. add Transmission Owner. The SDT retained the existing levels of the VSLs, which is consistent with both the PRC-024-2 and PRC-

024-1 VSLs. As a result, the [justification](#) for the Commission-approved PRC-024-1 Requirement R4 VSL supports the justification for the proposed PRC-024-3, Requirement R4 VSL.

VRF Justification for PRC-024-3, Requirement D.A.2.

The SDT made changes to conform the Requirement D.A.2. VSL to the revised Requirement 2 language with the addition of different no trip voltage boundaries based on power plant type as designated by the Planning Coordinator.

VSL Justification for PRC-024-3, Requirement D.A.2.

The SDT only made changes to conform Requirement D.A.2. with the Requirement R2 VSL as well as to add that newly designated strategic power plants have no less than 48 months to set their protection in accordance with the strategic power plant voltage boundaries in Attachment 2a. The SDT retained the binary structure of the VSL, which is consistent with both the PRC-024-2 and PRC-024-1 VSLs. As a result, the justification for the Commission-approved PRC-024-1 Requirement R2 VSL supports the justification for the proposed PRC-024-3, Requirement D.A.2. VSL.

VRF Justification for PRC-024-3, Requirement D.A.5.

The VRF for Requirement D.A.5. is Medium, given that is unlikely to lead to Bulk Electric System instability, separation, or cascading failures if violated. This is consistent with Requirements R1, R2, and D.A.2.

VSL Justification for PRC-024-3, Requirement D.A.5.

Proposed VSL's incorporate the increments for tardiness methodology. Proposed VSL language does not include ambiguous terms and ensure uniformity and consistency in the determination of penalties based on timeliness of the action specified. Proposed VSL's are based on a single violation and not a cumulative violation methodology.

Implementation Plan

Project 2018-04 Modifications to PRC-024-2 Reliability Standard PRC-024-3

Applicable Standard

- Reliability Standard PRC-024-3 – ~~Generator~~ Frequency and Voltage Protection Settings for Generating Resources

Requested Retirement

- Reliability Standard PRC-024-2 – Generator Frequency and Voltage Protective Relay Settings

Prerequisite Standard(s)

- None

Applicable Entities

- Generator Owners that apply protection listed in Section 4.2.1.
- Transmission Owners (in the Quebec Interconnection only) that own a BES generator step-up (GSU) transformer or main power transformer (MPT) and apply protection listed in Section 4.2.1.
- Planning Coordinators (in the Quebec Interconnection only).
- ~~Generator Owners that apply protection listed in Section 4.2.1.~~
- ~~Transmission Owners that own a BES generator step-up transformer or collector transformer and apply protection listed in Section 4.2.1.~~

Background

Reliability Standard PRC-024-3 contains a series of revisions and clarifications intended to help ensure that inverter-based resources respond to grid disturbances in a manner that contributes to the reliable operation of the Bulk-Power System.

The standard was revised to address recommendations of the NERC Inverter-Based Resource Performance Task Force. These recommendations were developed in response to the findings and recommendations of the NERC and WECC analysis of the Blue Cut Fire and Canyon 2 Fire disturbances in southern California.

In addition, the standard includes a Regional Variance for the Quebec Interconnection and related revisions to clarify the applicability of the standard in that Interconnection.

Address issues related to IBRs dropping offline

On November 27, 2018, the NERC Operating Committee (OC) and Planning Committee (PC) submitted a Standard Authorization Request (SAR) prepared by the Inverter-Based Resource Performance Task Force (IRPTF), which reports to the OC and PC. Project 2018-04 addresses this SAR.

In 2017, the OC and PC convened the IRPTF shortly after it became clear that inverter-based generation was dropping off line during normally cleared Bulk Power System (BPS) line faults. The NERC IRPTF supported NERC and WECC staff in the analysis of the Blue Cut Fire and Canyon 2 Fire disturbances in southern California. From the key findings and recommendations in the reports on the analysis, the IRPTF (as a stakeholder group of industry experts) developed recommended performance characteristics from inverter-based resources connected to the BPS.

Based off the disturbance analyses and development of the PRC-024-2 Gaps Whitepaper, the IRPTF identified potential modifications to PRC-024-2 to help ensure that inverter-based generator owners, operators, developers, and equipment manufacturers understand the intent of the standard in order for their plants respond to grid disturbances in a manner that contributes to the reliable operation of the BPS.

Supplemental SAR

General Considerations

This Implementation Plan is intended to provide applicable entities with sufficient time to evaluate settings, make changes for applicable equipment, and purchase necessary equipment, if necessary. Setting changes and equipment installations are typically completed during generating Facility outages, which may be scheduled in up to twenty-four (24) month intervals. includes an effective date as well as phased-in compliance dates. As detailed below, there are two compliance dates: one for Generator Owners, and one for Transmission Owners.

Effective Date

Reliability Standard PRC-024-3

Where approval by an applicable governmental authority is required, the standard shall become effective on the first day of the first calendar quarter that is twenty-four (24) eighteen (18) months after the effective date of the applicable governmental authority's order approving the standard, or as otherwise provided for by the applicable governmental authority.

Where approval by an applicable governmental authority is not required, the standard shall become effective on the first day of the first calendar quarter that is twenty-four (24) eighteen (18) months after the date the standard is adopted by the NERC Board of Trustees, or as otherwise provided for in that jurisdiction.

Compliance Date for Applicable Generator Owners

~~Applicable Generator Owners shall comply with all Requirements upon the effective date of Reliability Standard PRC-024-3.~~

Retirement Date

Reliability Standard PRC-024-2

Reliability Standard PRC-024-2 shall be retired immediately prior to the effective date of Reliability Standard PRC-024-3 in the particular jurisdiction in which the revised standard is becoming effective.

DRAFT Reliability Standard Audit Worksheet¹

PRC-024-3 – Frequency and Voltage Protection Settings for Generating Resources

This section to be completed by the Compliance Enforcement Authority.

Audit ID: Audit ID if available; or REG-NCRnnnnn-YYYYMMDD
Registered Entity: Registered name of entity being audited
NCR Number: NCRnnnnn
Compliance Enforcement Authority: Region or NERC performing audit
Compliance Assessment Date(s)²: Month DD, YYYY, to Month DD, YYYY
Compliance Monitoring Method: [On-site Audit | Off-site Audit | Spot Check]
Names of Auditors: Supplied by CEA

Applicability of Requirements³

	BA	DP	GO	GOP	IA	LSE	PA	PSE	RC	RP	RSG	TO	TOP	TP	TSP
R1			X									X			
R2			X									X			
R3			X									X			
R4			X									X			

Legend:

Text with blue background:	Fixed text – do not edit
Text entry area with Green background:	Entity-supplied information
Text entry area with white background:	Auditor-supplied information

¹ NERC developed this Reliability Standard Audit Worksheet (RSAW) language in order to facilitate NERC’s and the Regional Entities’ assessment of a registered entity’s compliance with this Reliability Standard. The NERC RSAW language is written to specific versions of each NERC Reliability Standard. Entities using this RSAW should choose the version of the RSAW applicable to the Reliability Standard being assessed. While the information included in this RSAW provides some of the methodology that NERC has elected to use to assess compliance with the requirements of the Reliability Standard, this document should not be treated as a substitute for the Reliability Standard or viewed as additional Reliability Standard requirements. In all cases, the Regional Entity should rely on the language contained in the Reliability Standard itself, and not on the language contained in this RSAW, to determine compliance with the Reliability Standard. NERC’s Reliability Standards can be found on NERC’s website. Additionally, NERC Reliability Standards are updated frequently, and this RSAW may not necessarily be updated with the same frequency. Therefore, it is imperative that entities treat this RSAW as a reference document only, and not as a substitute or replacement for the Reliability Standard. It is the responsibility of the registered entity to verify its compliance with the latest approved version of the Reliability Standards, by the applicable governmental authority, relevant to its registration status.

The RSAW may provide a non-exclusive list, for informational purposes only, of examples of the types of evidence a registered entity may produce or may be asked to produce to demonstrate compliance with the Reliability Standard. A registered entity’s adherence to the examples contained within this RSAW does not necessarily constitute compliance with the applicable Reliability Standard, and NERC and the Regional Entity using this RSAW reserve the right to request additional evidence from the registered entity that is not included in this RSAW. This RSAW may include excerpts from FERC Orders and other regulatory references which are provided for ease of reference only, and this document does not necessarily include all applicable Order provisions. In the event of a discrepancy between FERC Orders, and the language included in this document, FERC Orders shall prevail.

² Compliance Assessment Date(s): The date(s) the actual compliance assessment (on-site audit, off-site spot check, etc.) occurs.

³ Refer to PRC-024-3 Section 4, Applicability, to determine which GOs and TOs are subject to PRC-024-3.

DRAFT NERC Reliability Standard Audit Worksheet

Findings

(This section to be completed by the Compliance Enforcement Authority)

Req.	Finding	Summary and Documentation	Functions Monitored
R1			
R2			
R3			
R4			

Req.	Areas of Concern

Req.	Recommendations

Req.	Positive Observations

DRAFT NERC Reliability Standard Audit Worksheet

Subject Matter Experts

Identify the Subject Matter Expert(s) responsible for this Reliability Standard.

Registered Entity Response (Required; Insert additional rows if needed):

SME Name	Title	Organization	Requirement(s)

DRAFT

R1 Supporting Evidence and Documentation

- R1.** Each Generator Owner shall set its applicable frequency protection⁴ in accordance with PRC-024 Attachment 1 such that the applicable protection does not cause the generating resource to trip or cease injecting current during a frequency excursion within the “no trip zone”, with the following exception:
- Applicable frequency protection may be set to trip or cease injecting current within a portion of the “no trip zone” for documented and communicated regulatory or equipment limitations in accordance with Requirement R3.

M1. Each Generator Owner shall have evidence that the applicable frequency protection has been set in accordance with Requirement R1 such as dated setting sheets, calibration sheets, calculations, or other documentation.

Registered Entity Response (Required):

Question: Does your entity own any applicable frequency protection set to trip or cease injecting current during a frequency excursion in accordance with Requirement R1? Yes No

If yes, provide a summary of the applicable frequency protection in the box below, and proceed to the Registered Entity Response section below.

[Note: A separate spreadsheet or other document may be used. If so, provide the document reference below.]

Registered Entity Response (Required):

Compliance Narrative:

Provide a brief explanation, in your own words, of how you comply with this Requirement. References to supplied evidence, including links to the appropriate page, are recommended.

Evidence Requested:

Provide the following evidence, or other evidence to demonstrate compliance.
A list of all applicable frequency protection that is set to trip or cease injecting current during a frequency excursion for applicable generating resource(s).
A list of applicable frequency protection that has exceptions, as listed in Requirement R1, including the reason for each exception.
For all, or a sample of applicable frequency protection selected by the auditor, dated setting sheets, calibration sheets, calculations, or other documentation that demonstrate that applicable frequency protection settings were set such that the applicable frequency protection does not trip or cease injecting current during a frequency excursion for the applicable generating resource(s) within the “no trip zone” of

⁴ Frequency, voltage, and volts per hertz protection (whether provided by relaying or functions within associated control systems) that respond to electrical signals and: (i) directly trip the generating resource(s); or (ii) provide signals to the generating resource(s) to either trip or cease injecting current.

DRAFT NERC Reliability Standard Audit Worksheet

PRC-024 Attachment 1.

Registered Entity Evidence (Required):

The following information is requested for each document submitted as evidence. Also, evidence submitted should be highlighted and bookmarked, as appropriate, to identify the exact location where evidence of compliance may be found.

File Name	Document Title	Revision or Version	Document Date	Relevant Page(s) or Section(s)	Description of Applicability of Document

Audit Team Evidence Reviewed (This section to be completed by the Compliance Enforcement Authority):

Compliance Assessment Approach Specific to PRC-024-3, R1

This section to be completed by the Compliance Enforcement Authority

	Select all, or a sample thereof, applicable frequency protection and verify the settings are set to prevent the applicable generating resources from tripping or ceasing to inject current during a frequency excursion within the “no trip zone” of PRC-024-3 Attachment 1 (unless the specified exception applies).

Notes to Auditor:

Section 4 of the Standard, Applicability, guides the applicable protection to which this requirement pertains. Applicable frequency protection must be set within high and low frequency limits, and frequency duration limits per PRC-024 Attachment 1. Furthermore, the auditor needs to ensure the compliance assessment is performed with the appropriate Interconnection curve.

Auditor Notes:

--

R2 Supporting Evidence and Documentation

- R2.** Each Generator Owner shall set its applicable voltage protection⁵ in accordance with PRC-024 Attachment 2, such that the applicable protection does not cause the generating resource to trip or cease injecting current within the “no trip zone” during a voltage excursion at the high side of the GSU or MPT, subject to the following exceptions:
- If the Transmission Planner allows less stringent voltage protection settings than those required to meet PRC-024 Attachment 2, then the Generator Owner may set its protection within the voltage recovery characteristics of a location-specific Transmission Planner’s study.
 - Applicable voltage protection may be set to trip or cease injecting current during a voltage excursion within a portion of the “no trip zone” for documented and communicated regulatory or equipment limitations in accordance with Requirement R3.
- M2.** Each Generator Owner shall have evidence that applicable voltage protection has been set in accordance with Requirement R2, such as dated setting sheets, voltage-time curves, calibration sheets, coordination plots, dynamic simulation studies, calculations, or other documentation.

Registered Entity Response (Required):

Question: Does your entity own any applicable voltage protection set to trip or cease injecting current during a voltage excursion in accordance with Requirement R2? Yes No

If yes, provide a summary of the applicable voltage protection in the box below, and proceed to the Registered Entity Response section below.

[Note: A separate spreadsheet or other document may be used. If so, provide the document reference below.]

Evidence Requested¹:

Provide the following evidence, or other evidence to demonstrate compliance.
A list of all applicable voltage protection that is set to trip or cease injecting current during a voltage excursion for applicable generating resource(s).
A list of applicable voltage protection that has exceptions, as listed in Requirement R2, including the reason for each exception.
For all, or a sample of applicable voltage protection selected by the auditor, dated setting sheets, voltage-time curves, calibration sheets, coordination plots, dynamic simulation studies, calculations, or other documentation that demonstrates that applicable voltage protection were set such that the applicable voltage protection does not trip or cease injecting current during a voltage excursion for the applicable generating resource(s) within the “no trip zone” of PRC-024 Attachment 2.
If the Transmission Planner allows less stringent voltage settings than those required to meet PRC-024 Attachment 2, then provide documentation of the less stringent settings including the Transmission Planner’s

⁵ Frequency, voltage, and volts per hertz protection (whether provided by relaying or functions within associated control systems) that respond to electrical signals and: (i) directly trip the generating resource(s); or (ii) provide signals to the generating resource(s) to either trip or cease injecting current.

DRAFT NERC Reliability Standard Audit Worksheet

location-specific study.

Registered Entity Evidence (Required):

The following information is requested for each document submitted as evidence. Also, evidence submitted should be highlighted and bookmarked, as appropriate, to identify the exact location where evidence of compliance may be found.

File Name	Document Title	Revision or Version	Document Date	Relevant Page(s) or Section(s)	Description of Applicability of Document

Audit Team Evidence Reviewed (This section to be completed by the Compliance Enforcement Authority):

Compliance Assessment Approach Specific to PRC-024-3, R2

This section to be completed by the Compliance Enforcement Authority

	Select all, or a sample thereof, applicable voltage protection, and verify the settings are set to prevent the applicable generating resources from tripping or ceasing to inject current during a voltage excursion within the “no trip zone” of PRC-024-2 Attachment 2 (unless one of two specified exceptions applies).
Note to Auditor: Section 4 of the Standard, Applicability, guides the applicable protection to which this requirement pertains. Applicable voltage protection must be set within high and low voltage limits, and durations per PRC-024 Attachment 2. Reference the “Voltage Ride-Through Curve Clarifications” in Attachment 2.	

Auditor Notes:

R3 Supporting Evidence and Documentation

R3. Each Generator Owner shall document each known regulatory or equipment limitation⁶ that prevents applicable generating resource(s) with frequency or voltage protection from meeting the protection setting criteria in Requirements R1 or R2, including (but not limited to) study results, experience from an actual event, or manufacturer’s advice.

3.1. The Generator Owner shall communicate the documented regulatory or equipment limitation, or the removal of a previously documented regulatory or equipment limitation, to its Planning Coordinator and Transmission Planner within 30 calendar days of any of the following:

- Identification of a regulatory or equipment limitation.
- Repair of the equipment causing the limitation that removes the limitation.
- Replacement of the equipment causing the limitation with equipment that removes the limitation.
- Creation or adjustment of an equipment limitation caused by consumption of the cumulative turbine life-time frequency excursion allowance.

M3. Each Generator Owner shall have evidence that it has documented and communicated any known regulatory or equipment limitations that resulted in an exception to Requirements R1 or R2 in accordance with Requirement R3, such as a dated email or letter that contains such documentation as study results, experience from an actual event, or manufacturer’s advice.

Registered Entity Response (Required):

Question: Did your entity have any known regulatory or equipment limitation that prevents applicable generating resource(s) with frequency or voltage protection from meeting the setting criteria in Requirements R1 or R2 in accordance with Requirement R3 during the audit period? Yes No

If yes, provide a summary of the known regulatory or equipment limitations in the box below, and proceed to the Registered Entity Response section below.

[Note: A separate spreadsheet or other document may be used. If so, provide the document reference below.]

Question: Did your entity have any removal of a previously documented regulatory or equipment limitation in accordance with Requirement R3 during the audit period? Yes No

If yes, provide a summary of the removal of the previously documented regulatory or equipment limitation(s) in the box below, and proceed to the Registered Entity Response section below.

[Note: A separate spreadsheet or other document may be used. If so, provide the document reference below.]

⁶ Excludes limitations caused by the setting capability of the frequency and voltage protective relays for the generating resource(s) but does not exclude limitations originating in the equipment that the relays protect or frequency and voltage protection imbedded in control systems.

DRAFT NERC Reliability Standard Audit Worksheet

Registered Entity Response (Required):

Compliance Narrative:

Provide a brief explanation, in your own words, of how you comply with this Requirement. References to supplied evidence, including links to the appropriate page, are recommended.

Evidence Requested:

Provide the following evidence, or other evidence to demonstrate compliance.
Provide a list of each known regulatory or equipment limitation that prevents an applicable generating resource with frequency or voltage protection from meeting the setting criteria in Requirements R1 or R2 in accordance with Requirement R3.
Provide a list of the removal(s) of a previously documented regulatory or equipment limitation in accordance with Requirement R3.
For all, or a sample selected by the auditor, dated email or letter that documents the entity communicated any known regulatory or equipment limitations, and removals of a previously documented regulatory or equipment limitation, to its Planning Coordinator and Transmission Planner within 30 calendar days in accordance with Requirement R3.

Registered Entity Evidence (Required):

The following information is requested for each document submitted as evidence. Also, evidence submitted should be highlighted and bookmarked, as appropriate, to identify the exact location where evidence of compliance may be found.

File Name	Document Title	Revision or Version	Document Date	Relevant Page(s) or Section(s)	Description of Applicability of Document

Audit Team Evidence Reviewed (This section to be completed by the Compliance Enforcement Authority):

Compliance Assessment Approach Specific to PRC-024-3, R3

This section to be completed by the Compliance Enforcement Authority

Select all, or a sample thereof, and verify the entity documented each known regulatory or equipment limitation that prevents an applicable generating resource with frequency or voltage protection from meeting the setting criteria in Requirements R1 or R2 in accordance with Requirement R3, and the entity is meeting the Implementation Plan.

DRAFT NERC Reliability Standard Audit Worksheet

Select all, or a sample thereof, and verify the entity communicated the documented regulatory or equipment limitation, or the removal of a previously documented regulatory or equipment limitation, to its Planning Coordinator and Transmission Planner within 30 calendar days in accordance with Requirement R3 for any of the following:

- Identification of a regulatory or equipment limitation.
- Repair of the equipment causing the limitation that removes the limitation.
- Replacement of the equipment causing the limitation with equipment that removes the limitation.
- Creation or adjustment of an equipment limitation caused by consumption of the cumulative turbine life-time frequency excursion allowance.

Note to Auditor: Reference footnote 4 (of the Standard, footnote 6 in the RSAW) which states: “Excludes limitations caused by the setting capability of the frequency and voltage protective relays for the generating resource(s) but does not exclude limitations originating in the equipment that the relays protect or frequency and voltage protection imbedded in control systems.”

Auditor Notes:

--

R4 Supporting Evidence and Documentation

- R4.** Each Generator Owner shall provide its applicable protection settings associated with Requirements R1 and R2 to the Planning Coordinator or Transmission Planner that models the associated generating resource(s) within 60 calendar days of receipt of a written request for the data and within 60 calendar days of any change to those previously requested settings unless directed by the requesting Planning Coordinator or Transmission Planner that the reporting of protection setting changes is not required.

- M4.** Each Generator Owner shall have evidence that it communicated applicable protection settings in accordance with Requirement R4, such as dated e-mails, correspondence or other evidence and copies of any requests it has received for that information.

Registered Entity Response (Required):

Question: Did your entity receive a written request for the data (applicable protection settings associated with Requirements R1 and R2) from the Planning Coordinator or Transmission Planner that models the associated resource during the audit period? Yes No

If yes, provide a summary of the written requests in the box below, including the name of the Planning Coordinator and Transmission Planner, and proceed to the Registered Entity Response section below.

[Note: A separate spreadsheet or other document may be used. If so, provide the document reference below.]

Question (Required): Did your entity have any changes to those previously requested settings? Yes No

If yes, provide a summary of the previously requested settings, and whether your entity was directed by the requesting Planning Coordinator or Transmission Planner that the reporting of protection setting changes is not required, and proceed to the Registered Entity Response section below.

[Note: A separate spreadsheet or other document may be used. If so, provide the document reference below.]

Registered Entity Response (Required):

Compliance Narrative:

Provide a brief explanation, in your own words, of how you comply with this Requirement. References to supplied evidence, including links to the appropriate page, are recommended.

Evidence Requested:

Provide the following evidence, or other evidence to demonstrate compliance.

Provide a list of all applicable protection settings associated with Requirements R1 and R2 that are associated with any written requests for the data by the Planning Coordinator or Transmission Planner that models the associated unit.

DRAFT NERC Reliability Standard Audit Worksheet

Provide a list of any change to those previously requested settings (unless directed by the requesting Planning Coordinator or Transmission Planner that the reporting of protection setting changes is not required).

For all, or a sample selected by the auditor, dated e-mails, correspondence or other evidence and copies of any requests, that show the entity communicated applicable protection settings/changes within 60 calendar days of the written request in accordance with R4.

Registered Entity Evidence (Required):

The following information is requested for each document submitted as evidence. Also, evidence submitted should be highlighted and bookmarked, as appropriate, to identify the exact location where evidence of compliance may be found.

File Name	Document Title	Revision or Version	Document Date	Relevant Page(s) or Section(s)	Description of Applicability of Document

Audit Team Evidence Reviewed (This section to be completed by the Compliance Enforcement Authority):

Compliance Assessment Approach Specific to PRC-024-3, R4

This section to be completed by the Compliance Enforcement Authority

Select all, or a sample thereof, and verify the entity communicated applicable protection settings/changes (such as dated e-mails, correspondence or other evidence, and copies of any requests) within 60 calendar days of the written request/change in accordance with R4.

Note to Auditor: Section 4 of the Standard, Applicability, guides the applicable protection to which this requirement, and R1 and R2, pertains.

Auditor Notes:

--

Additional Information:

Reliability Standard

The RSAW developer should provide the following information without hyperlinks. Update the information below as appropriate.

The full text of STD-OXX-N may be found on the NERC Web Site (www.nerc.com) under “Program Areas & Departments”, “Reliability Standards.”

In addition to the Reliability Standard, there is an applicable Implementation Plan available on the NERC Web Site.

In addition to the Reliability Standard, there is background information available on the NERC Web Site.

Capitalized terms in the Reliability Standard refer to terms in the NERC Glossary, which may be found on the NERC Web Site.

Sampling Methodology [If developer deems reference applicable]

Sampling is essential for auditing compliance with NERC Reliability Standards since it is not always possible or practical to test 100% of either the equipment, documentation, or both, associated with the full suite of enforceable standards. The Sampling Methodology Guidelines and Criteria (see NERC website), or sample guidelines, provided by the Electric Reliability Organization help to establish a minimum sample set for monitoring and enforcement uses in audits of NERC Reliability Standards.

Regulatory Language [Developer to ensure RSAW has been provided to NERC Legal for links to appropriate Regulatory Language – See example below]

E.g. FERC Order No. 742 paragraph 34: “Based on NERC’s.....”

E.g. FERC Order No. 742 Paragraph 55, Commission Determination: “We affirm NERC’s.....”

Selected Glossary Terms [If developer deems applicable]

The following Glossary terms are provided for convenience only. Please refer to the NERC web site for the current enforceable terms.

DRAFT NERC Reliability Standard Audit Worksheet

Revision History for RSAW

Version	Date	Reviewers	Revision Description
1	4/29/19	NERC Compliance Assurance, RSAW Task Force	Draft to accompany first posting
2	10/7/19	NERC Compliance Assurance, RSAW Task Force	Draft to accompany second posting

ⁱ Items in the Evidence Requested section are suggested evidence that may, but will not necessarily, demonstrate compliance. These items are not mandatory and other forms and types of evidence may be submitted at the entity's discretion.

DRAFT

Standards Announcement

Project 2018-04 Modifications to PRC-024-2

Additional Ballot and Non-ballot Poll Open through November 4, 2019

[Now Available](#)

The additional ballot and non-binding poll for **PRC-024-3 – Generator Frequency and Voltage Protection Settings** are open until **8 p.m. Eastern, Monday, November 4, 2019**.

The standard drafting team's considerations of the responses received from the last comment period are reflected in this draft of the standard.

Balloting

Members of the ballot pools associated with this project can log into the [Standards Balloting and Commenting System \(SBS\)](#) and submit votes. Contact [Wendy Muller](#) regarding issues using the SBS.

- *Contact NERC IT support directly at <https://support.nerc.net/> (Monday – Friday, 8 a.m. - 5 p.m. Eastern) for problems regarding accessing the SBS due to a forgotten password, incorrect credential error messages, or system lock-out.*
- *Passwords expire every **6 months** and must be reset.*
- *The SBS is **not** supported for use on mobile devices.*
- *Please be mindful of ballot and comment period closing dates. We ask to **allow at least 48 hours** for NERC support staff to assist with inquiries. Therefore, it is recommended that users try logging into their SBS accounts **prior to the last day** of a comment/ballot period.*

Next Steps

The ballot results will be announced and posted on the project page. The drafting team will review all responses received during the comment period and determine the next steps of the project.

For information on the Standards Development Process, refer to the [Standard Processes Manual](#).

[Subscribe to this project's observer mailing list](#) by selecting "NERC Email Distribution Lists" from the "Applications" drop-down menu and specify "Project 2018-04 Modifications to PRC-024-2 Observer List" in the Description Box. For more information or assistance, contact Senior Standards Developers, [Alison Oswald](#) (via email) or at (404) 446-9675 or [Latrice Harkness](#) (via email) or at 404-446-9728.

North American Electric Reliability Corporation
3353 Peachtree Rd, NE
Suite 600, North Tower
Atlanta, GA 30326
404-446-2560 | www.nerc.com

Unofficial Comment Form

Project 2018-04 Modifications to PRC-024-2

Do not use this form for submitting comments. Use the [Standards Balloting and Commenting System \(SBS\)](#) to submit comments on the **Project 2018-04 Modifications to PRC-024-2 by 8 p.m. Eastern, Monday, November 4, 2019.**

See the [project page](#) or contact Standards Developer, [Mat Bunch](#) (via email) or at (404) 446-9785 for more information or assistance.

Background Information

On November 27, 2018, the NERC Operating Committee (OC) and Planning Committee (PC) submitted a Standard Authorization Request (SAR) prepared by the Inverter-Based Resource Performance Task Force (IRPTF), which reports to the OC and PC.

Based off the analyses of the [Blue Cut Fire](#) and [Canyon 2 Fire](#) disturbances in southern California along with the development of the [PRC-024-2 Gaps Whitepaper](#), the IRPTF identified potential modifications to PRC-024-2 to ensure that inverter-based generator owners, operators, developers, and equipment manufacturers understand the intent of the standard in order for their plants to respond to grid disturbances in a manner that contributes to the reliable operation of the BPS. In order to address the issues in the [SAR](#), the standard drafting team developed the proposed modifications in PRC-024-3.

Questions

1. Based on industry feedback, the SDT removed the Transmission Owner (TO) from the Applicability (Functional Entities) of PRC-024-3. Do you agree with this change? If not, please provide the basis for your disagreement and a specific instance where not including the TO would present a risk to reliability.

Yes

No

Comments:

2. Based on industry feedback, the SDT modified the Applicability (Facilities) to clarify both the types of 'protection' applicable, if activated, and the specific equipment the 'protection' is applied on. Do you agree with these changes? If not, please provide the basis for your disagreement and an alternate solution.

Yes

No

Comments:

3. To address Scope Item 'f' from the approved SAR, the SDT added an exemption to the Applicability (Facilities) to clarify that all auxiliary equipment and associated protection(s) within the generating

Facility are not applicable to the standard. Do you agree with the 'Exemption'? If not, please provide the basis for your disagreement and an alternate solution.

- Yes
 No

Comments:

4. Based on industry feedback, the SDT replaced the 0.1 second 'Minimum Time (Sec)' value in the frequency tables with "Instantaneous" and provided additional clarity via Footnote #6 regarding frequency calculation/measurement. Do you agree with this change? If not, please provide the basis for your disagreement and an alternate solution.

- Yes
 No

Comments:

5. Based on industry feedback, the SDT revised the Implementation Plan to provide twenty-four months for applicable entities to evaluate settings, make changes for applicable equipment, and purchase necessary equipment, if necessary. Do you agree with the revised Implementation Plan? If not, please provide the basis for your disagreement and an alternate proposal.

- Yes
 No

Comments:

6. Do you agree that the proposed modifications provide a cost-effective means of addressing issues identified in the SAR? If not, please provide an alternative, more cost-effective manner in which to achieve at least an equivalent level of reliability.

- Yes
 No

Comments:

Standards Announcement

Project 2018-04 Modifications to PRC-024-2

Formal Comment Period Open through November 4, 2019

[Now Available](#)

A 45-day comment period for **PRC-024-3 – Generator Frequency and Voltage Protection Settings** is open until **8 p.m. Eastern, Monday, November 4, 2019**.

Commenting

Use the [Standards Balloting and Commenting System \(SBS\)](#) to submit comments. If you experience issues using the SBS, contact [Wendy Muller](#). An unofficial Word version of the comment form is posted on the [project page](#).

- *Contact NERC IT support directly at <https://support.nerc.net/> (Monday-Friday, 8 a.m. - 5 p.m. Eastern) for problems regarding accessing the SBS due to a forgotten password, incorrect credential error messages, or system lock-out.*
- *Passwords expire every **6 months** and must be reset.*
- *The SBS is **not** supported for use on mobile devices.*
- *Please be mindful of ballot and comment period closing dates. We ask to **allow at least 48 hours** for NERC support staff to assist with inquiries. Therefore, it is recommended that users try logging into their SBS accounts **prior to the last day** of a comment/ballot period.*

Next Steps

A 10-day additional ballot for the standard and a non-binding poll of the associated Violation Risk Factors and Violation Severity Levels, will be conducted **October 25 - November 4, 2019**.

For information on the Standards Development Process, refer to the [Standard Processes Manual](#).

[Subscribe to this project's observer mailing list](#) by selecting "NERC Email Distribution Lists" from the "Applications" drop-down menu and specify "Project 2018-04 Modifications to PRC-024-2 Observer List" in the Description Box. For more information or assistance, contact Standards Developer, [Mat Bunch](#) (via email) or at (404) 446-9785.

North American Electric Reliability Corporation
3353 Peachtree Rd, NE
Suite 600, North Tower
Atlanta, GA 30326
404-446-2560 | www.nerc.com

BALLOT RESULTS

Comment: View Comment Results (/CommentResults/Index/181)

Ballot Name: 2018-04 Modifications to PRC-024-2 PRC-024-3 AB 2 ST

Voting Start Date: 10/25/2019 12:01:00 AM

Voting End Date: 11/4/2019 8:00:00 PM

Ballot Type: ST

Ballot Activity: AB

Ballot Series: 2

Total # Votes: 244

Total Ballot Pool: 298

Quorum: 81.88

Quorum Established Date: 11/4/2019 5:00:03 PM

Weighted Segment Value: 86.67

Segment	Ballot Pool	Segment Weight	Affirmative Votes	Affirmative Fraction	Negative Votes w/ Comment	Negative Fraction w/ Comment	Negative Votes w/o Comment	Abstain	No Vote
Segment: 1	73	1	51	0.879	7	0.121	0	5	10
Segment: 2	7	0.4	4	0.4	0	0	0	0	3
Segment: 3	73	1	48	0.873	7	0.127	0	1	17
Segment: 4	18	1	10	0.833	2	0.167	0	1	5
Segment: 5	70	1	48	0.842	9	0.158	0	2	11
Segment: 6	48	1	33	0.846	6	0.154	0	1	8
Segment: 7	0	0	0	0	0	0	0	0	0
Segment: 8	1	0.1	1	0.1	0	0	0	0	0

Segment	Ballot Pool	Segment Weight	Affirmative Votes	Affirmative Fraction	Negative Votes w/ Comment	Negative Fraction w/ Comment	Negative Votes w/o Comment	Abstain	No Vote
Segment: 9	1	0.1	1	0.1	0	0	0	0	0
Segment: 10	7	0.6	5	0.5	1	0.1	0	1	0
Totals:	298	6.2	201	5.374	32	0.826	0	11	54

BALLOT POOL MEMBERS

Show entries

Search:

Segment	Organization	Voter	Designated Proxy	Ballot	NERC Memo
1	AEP - AEP Service Corporation	Dennis Sauriol		Negative	Comments Submitted
1	Allete - Minnesota Power, Inc.	Jamie Monette		Affirmative	N/A
1	Ameren - Ameren Services	Eric Scott		Affirmative	N/A
1	APS - Arizona Public Service Co.	Michelle Amarantos		Affirmative	N/A
1	Arizona Electric Power Cooperative, Inc.	Ben Engelby		None	N/A
1	Associated Electric Cooperative, Inc.	Mark Riley		None	N/A
1	Avista - Avista Corporation	Mike Magruder		Affirmative	N/A
1	Balancing Authority of Northern California	Kevin Smith	Joe Tarantino	Affirmative	N/A

Segment	Organization	Voter	Designated Proxy	Ballot	NERC Memo
1	BC Hydro and Power Authority	Adrian Andreoiu		Affirmative	N/A
1	Beaches Energy Services	Don Cuevas	Brandon McCormick	None	N/A
1	Black Hills Corporation	Wes Wingen		Affirmative	N/A
1	Bonneville Power Administration	Kammy Rogers-Holliday		Affirmative	N/A
1	CenterPoint Energy Houston Electric, LLC	Daniela Hammons		Affirmative	N/A
1	Central Electric Power Cooperative (Missouri)	Michael Bax		Affirmative	N/A
1	City Utilities of Springfield, Missouri	Michael Buyce		Affirmative	N/A
1	CMS Energy - Consumers Energy Company	Donald Lynd		Negative	Comments Submitted
1	Colorado Springs Utilities	Mike Braunstein		Affirmative	N/A
1	Con Ed - Consolidated Edison Co. of New York	Dermot Smyth		Affirmative	N/A
1	Dairyland Power Cooperative	Renee Leidel		Abstain	N/A
1	Dominion - Dominion Virginia Power	Candace Marshall		Negative	Comments Submitted
1	Duke Energy	Laura Lee		Negative	Comments Submitted
1	Edison International - Southern California Edison Company	Ayman Samaan		Affirmative	N/A
1	Entergy - Entergy Services, Inc.	Oliver Burke		Abstain	N/A
1	Exelon	Daniel Gacek		Affirmative	N/A
1	FirstEnergy - FirstEnergy Corporation	Julie Severino		Affirmative	N/A

Segment	Organization	Voter	Designated Proxy	Ballot	NERC Memo
1	Gainesville Regional Utilities	David Owens	Brandon McCormick	None	N/A
1	Georgia Transmission Corporation	Greg Davis		Affirmative	N/A
1	Glencoe Light and Power Commission	Terry Volkmann		Affirmative	N/A
1	Great Plains Energy - Kansas City Power and Light Co.	James McBee		Affirmative	N/A
1	Great River Energy	Gordon Pietsch		Affirmative	N/A
1	Hydro-Qu?bec TransEnergie	Nicolas Turcotte		Affirmative	N/A
1	Imperial Irrigation District	Jesus Sammy Alcaraz		Abstain	N/A
1	Lakeland Electric	Larry Watt		None	N/A
1	Lincoln Electric System	Danny Pudenz		Affirmative	N/A
1	Los Angeles Department of Water and Power	faranak sarbaz		None	N/A
1	Lower Colorado River Authority	Trey Melcher		None	N/A
1	M and A Electric Power Cooperative	William Price		Affirmative	N/A
1	Manitoba Hydro	Bruce Reimer		Affirmative	N/A
1	Muscatine Power and Water	Andy Kurriger		Affirmative	N/A
1	N.W. Electric Power Cooperative, Inc.	Mark Ramsey		Affirmative	N/A
1	National Grid USA	Michael Jones		Negative	Third-Party Comments
1	Nebraska Public Power District	Jamison Cawley		Affirmative	N/A
1	New York Power Authority	Salvatore Spagnolo		Affirmative	N/A

Segment	Organization	Voter	Designated Proxy	Ballot	NERC Memo
1	NextEra Energy - Florida Power and Light Co.	Mike O'Neil		Affirmative	N/A
1	NiSource - Northern Indiana Public Service Co.	Steve Toosevich		Affirmative	N/A
1	Northeast Missouri Electric Power Cooperative	Kevin White		Affirmative	N/A
1	OGE Energy - Oklahoma Gas and Electric Co.	Terri Pyle		Affirmative	N/A
1	Oncor Electric Delivery	Lee Maurer	Eric Shaw	None	N/A
1	Orlando Utilities Commission	Aaron Staley		Affirmative	N/A
1	Platte River Power Authority	Matt Thompson		Affirmative	N/A
1	PPL Electric Utilities Corporation	Brenda Truhe		Affirmative	N/A
1	PSEG - Public Service Electric and Gas Co.	Sean Cavote		Affirmative	N/A
1	Public Utility District No. 1 of Chelan County	Jeff Kimbell		Affirmative	N/A
1	Public Utility District No. 1 of Snohomish County	Long Duong		Affirmative	N/A
1	Puget Sound Energy, Inc.	Theresa Rakowsky		Affirmative	N/A
1	Sacramento Municipal Utility District	Arthur Starkovich	Joe Tarantino	Affirmative	N/A
1	Salt River Project	Steven Cobb		Affirmative	N/A
1	Santee Cooper	Chris Wagner		Affirmative	N/A
1	SaskPower	Wayne Guttormson		Affirmative	N/A
1	Seattle City Light	Pawel Krupa		Affirmative	N/A
1	Seminole Electric Cooperative, Inc.	Bret Galbraith		None	N/A

Segment	Organization	Voter	Designated Proxy	Ballot	NERC Memo
1	Sempra - San Diego Gas and Electric	Mo Derbas		Affirmative	N/A
1	Sho-Me Power Electric Cooperative	Peter Dawson		Affirmative	N/A
1	Southern Company - Southern Company Services, Inc.	Adrienne Collins		Negative	Comments Submitted
1	Tacoma Public Utilities (Tacoma, WA)	John Merrell		Affirmative	N/A
1	Tallahassee Electric (City of Tallahassee, FL)	Scott Langston		Abstain	N/A
1	Tennessee Valley Authority	Gabe Kurtz		Negative	Third-Party Comments
1	Tri-State G and T Association, Inc.	Kjersti Drott		None	N/A
1	U.S. Bureau of Reclamation	Richard Jackson		Affirmative	N/A
1	Unisource - Tucson Electric Power Co.	John Tolo		Affirmative	N/A
1	Westar Energy	Allen Klassen	Douglas Webb	Affirmative	N/A
1	Western Area Power Administration	sean erickson		Abstain	N/A
1	Xcel Energy, Inc.	Dean Schiro		Affirmative	N/A
2	California ISO	Jamie Johnson		Affirmative	N/A
2	Electric Reliability Council of Texas, Inc.	Brandon Gleason		Affirmative	N/A
2	Independent Electricity System Operator	Leonard Kula		Affirmative	N/A
2	Midcontinent ISO, Inc.	Bobbi Welch		None	N/A
2	New York Independent System Operator	Gregory Campoli		None	N/A
2	PJM Interconnection, L.L.C.	Mark Holman		Affirmative	N/A

Segment	Organization	Voter	Designated Proxy	Ballot	NERC Memo
2	Southwest Power Pool, Inc. (RTO)	Charles Yeung		None	N/A
3	AEP	Kent Feliks		Negative	Comments Submitted
3	AES - Indianapolis Power and Light Co.	Bette White		Affirmative	N/A
3	Ameren - Ameren Services	David Jendras		Affirmative	N/A
3	APS - Arizona Public Service Co.	Vivian Moser		Affirmative	N/A
3	Associated Electric Cooperative, Inc.	Todd Bennett		Affirmative	N/A
3	Austin Energy	W. Dwayne Preston		Affirmative	N/A
3	Avista - Avista Corporation	Scott Kinney		Affirmative	N/A
3	BC Hydro and Power Authority	Hootan Jarollahi		Affirmative	N/A
3	Beaches Energy Services	Steven Lancaster	Brandon McCormick	None	N/A
3	Berkshire Hathaway Energy - MidAmerican Energy Co.	Darnez Gresham		Affirmative	N/A
3	Black Hills Corporation	Eric Egge		Affirmative	N/A
3	Bonneville Power Administration	Ken Lanehome		Affirmative	N/A
3	Central Electric Power Cooperative (Missouri)	Adam Weber		Affirmative	N/A
3	City Utilities of Springfield, Missouri	Scott Williams		Affirmative	N/A
3	CMS Energy - Consumers Energy Company	Karl Blaszkowski		Negative	Comments Submitted
3	Colorado Springs Utilities	Hillary Dobson		Affirmative	N/A

Segment	Organization	Voter	Designated Proxy	Ballot	NERC Memo
3	Con Ed - Consolidated Edison Co. of New York	Peter Yost		Affirmative	N/A
3	Cowlitz County PUD	Russell Noble		Affirmative	N/A
3	CPS Energy	James Grimshaw		None	N/A
3	Dominion - Dominion Resources, Inc.	Connie Lowe		Negative	Comments Submitted
3	DTE Energy - Detroit Edison Company	Karie Barczak		None	N/A
3	Duke Energy	Lee Schuster		Negative	Comments Submitted
3	Edison International - Southern California Edison Company	Romel Aquino		Affirmative	N/A
3	Eversource Energy	Sharon Flannery		None	N/A
3	Exelon	Kinte Whitehead		Affirmative	N/A
3	FirstEnergy - FirstEnergy Corporation	Aaron Ghodooshim		Affirmative	N/A
3	Florida Municipal Power Agency	Dale Ray	Brandon McCormick	None	N/A
3	Gainesville Regional Utilities	Darko Kovac	Brandon McCormick	None	N/A
3	Georgia System Operations Corporation	Scott McGough		Affirmative	N/A
3	Great Plains Energy - Kansas City Power and Light Co.	John Carlson		Affirmative	N/A
3	Great River Energy	Brian Glover		Affirmative	N/A
3	JEA	Garry Baker		None	N/A
3	KAMO Electric Cooperative	Tony Gott		Affirmative	N/A
3	Lakeland Electric	Patricia Boody		None	N/A
3	Lincoln Electric System	Jason Fortik		Affirmative	N/A

Segment	Organization	Voter	Designated Proxy	Ballot	NERC Memo
3	Los Angeles Department of Water and Power	Tony Skourtas		Affirmative	N/A
3	M and A Electric Power Cooperative	Stephen Pogue		Affirmative	N/A
3	Manitoba Hydro	Karim Abdel-Hadi		Affirmative	N/A
3	MGE Energy - Madison Gas and Electric Co.	Ronald Bauer		None	N/A
3	Muscatine Power and Water	Seth Shoemaker		Affirmative	N/A
3	National Grid USA	Brian Shanahan		Negative	Third-Party Comments
3	Nebraska Public Power District	Tony Eddleman		Affirmative	N/A
3	New York Power Authority	David Rivera		Affirmative	N/A
3	NiSource - Northern Indiana Public Service Co.	Dmitriy Bazylyuk		Affirmative	N/A
3	North Carolina Electric Membership Corporation	doug white		None	N/A
3	Northeast Missouri Electric Power Cooperative	Skyler Wiegmann		Affirmative	N/A
3	NW Electric Power Cooperative, Inc.	John Stickley		Affirmative	N/A
3	Ocala Utility Services	Neville Bowen		Negative	Third-Party Comments
3	OGE Energy - Oklahoma Gas and Electric Co.	Donald Hargrove		Affirmative	N/A
3	Omaha Public Power District	Aaron Smith		Affirmative	N/A
3	Owensboro Municipal Utilities	Thomas Lyons		Abstain	N/A
3	Platte River Power Authority	Jeff Landis		Affirmative	N/A

Segment	Organization	Voter	Designated Proxy	Ballot	NERC Memo
3	PNM Resources - Public Service Company of New Mexico	Trevor Tidwell		None	N/A
3	Portland General Electric Co.	Dan Zollner		Affirmative	N/A
3	PPL - Louisville Gas and Electric Co.	James Frank		Affirmative	N/A
3	PSEG - Public Service Electric and Gas Co.	James Meyer		None	N/A
3	Public Utility District No. 1 of Chelan County	Joyce Gundry		Affirmative	N/A
3	Puget Sound Energy, Inc.	Tim Womack		Affirmative	N/A
3	Sacramento Municipal Utility District	Nicole Looney	Joe Tarantino	Affirmative	N/A
3	Salt River Project	Zack Heim		None	N/A
3	Santee Cooper	James Poston		Affirmative	N/A
3	Seminole Electric Cooperative, Inc.	Michael Lee		None	N/A
3	Sempra - San Diego Gas and Electric	Bridget Silvia		Affirmative	N/A
3	Sho-Me Power Electric Cooperative	Jeff Neas		Affirmative	N/A
3	Silicon Valley Power - City of Santa Clara	Val Ridad		None	N/A
3	Snohomish County PUD No. 1	Holly Chaney		Affirmative	N/A
3	Southern Company - Alabama Power Company	Joel Dembowski		Negative	Comments Submitted
3	Tacoma Public Utilities (Tacoma, WA)	Marc Donaldson		Affirmative	N/A
3	TECO - Tampa Electric Co.	Ronald Donahey		None	N/A

Segment	Organization	Voter	Designated Proxy	Ballot	NERC Memo
3	Tennessee Valley Authority	Ian Grant		None	N/A
3	WEC Energy Group, Inc.	Thomas Breene		Affirmative	N/A
3	Westar Energy	Bryan Taggart	Douglas Webb	Affirmative	N/A
3	Xcel Energy, Inc.	Michael Ibold		Affirmative	N/A
4	Alliant Energy Corporation Services, Inc.	Larry Heckert		Affirmative	N/A
4	Austin Energy	Jun Hua		None	N/A
4	City Utilities of Springfield, Missouri	John Allen		Affirmative	N/A
4	CMS Energy - Consumers Energy Company	Nicholas Tenney		Negative	Comments Submitted
4	FirstEnergy - FirstEnergy Corporation	Mark Garza		Affirmative	N/A
4	Florida Municipal Power Agency	Carol Chinn		Negative	Comments Submitted
4	Georgia System Operations Corporation	Andrea Barclay		Affirmative	N/A
4	Indiana Municipal Power Agency	Jack Alvey	Scott Berry	Abstain	N/A
4	Keys Energy Services	Nick Batty	Brandon McCormick	None	N/A
4	MGE Energy - Madison Gas and Electric Co.	Joseph DePoorter		Affirmative	N/A
4	North Carolina Electric Membership Corporation	Luis Fondacci	Kagen DelRio	Affirmative	N/A
4	Oklahoma Municipal Power Authority	Ashley Stringer		None	N/A
4	Public Utility District No. 1 of Snohomish County	John Martinsen		Affirmative	N/A

Segment	Organization	Voter	Designated Proxy	Ballot	NERC Memo
4	Public Utility District No. 2 of Grant County, Washington	Karla Weaver		None	N/A
4	Sacramento Municipal Utility District	Beth Tincher	Joe Tarantino	Affirmative	N/A
4	Seattle City Light	Hao Li		Affirmative	N/A
4	Tacoma Public Utilities (Tacoma, WA)	Hien Ho		Affirmative	N/A
4	Utility Services, Inc.	Brian Evans-Mongeon		None	N/A
5	AEP	Thomas Foltz		Negative	Comments Submitted
5	AES - AES Corporation	Leo Bernier		None	N/A
5	Ameren - Ameren Missouri	Sam Dwyer		Affirmative	N/A
5	APS - Arizona Public Service Co.	Kelsi Rigby		Affirmative	N/A
5	Associated Electric Cooperative, Inc.	Brad Haralson		Affirmative	N/A
5	Austin Energy	Lisa Martin		Affirmative	N/A
5	Avista - Avista Corporation	Glen Farmer		Affirmative	N/A
5	Basin Electric Power Cooperative	Mike Kraft		None	N/A
5	Berkshire Hathaway - NV Energy	Kevin Salsbury		Affirmative	N/A
5	Black Hills Corporation	George Tatar		Affirmative	N/A
5	Bonneville Power Administration	Scott Winner		Affirmative	N/A
5	Brazos Electric Power Cooperative, Inc.	Shari Heino		Affirmative	N/A
5	Choctaw Generation Limited Partnership, LLP	Rob Watson		Negative	Third-Party Comments

Segment	Organization	Voter	Designated Proxy	Ballot	NERC Memo
5	City of Independence, Power and Light Department	Jim Nail		Affirmative	N/A
5	City Water, Light and Power of Springfield, IL	Rick Meadows		None	N/A
5	CMS Energy - Consumers Energy Company	David Greyerbiehl		Negative	Comments Submitted
5	Con Ed - Consolidated Edison Co. of New York	William Winters	Daniel Valle	Affirmative	N/A
5	Cowlitz County PUD	Deanna Carlson		Affirmative	N/A
5	Dairyland Power Cooperative	Tommy Drea		None	N/A
5	Dominion - Dominion Resources, Inc.	Rachel Snead		Negative	Comments Submitted
5	DTE Energy - Detroit Edison Company	Adrian Raducea		None	N/A
5	Duke Energy	Dale Goodwine		Negative	Comments Submitted
5	Edison International - Southern California Edison Company	Neil Shockey		Affirmative	N/A
5	Exelon	Cynthia Lee		Affirmative	N/A
5	FirstEnergy - FirstEnergy Solutions	Robert Loy		Affirmative	N/A
5	Florida Municipal Power Agency	Chris Gowder		Negative	Comments Submitted
5	Great Plains Energy - Kansas City Power and Light Co.	Marcus Moor		Affirmative	N/A
5	Great River Energy	Preston Walsh		Affirmative	N/A
5	Herb Schrayshuen	Herb Schrayshuen		Affirmative	N/A
5	Imperial Irrigation District	Tino Zaragoza		Abstain	N/A

Segment	Organization	Voter	Designated Proxy	Ballot	NERC Memo
5	Lakeland Electric	Jim Howard		None	N/A
5	Lincoln Electric System	Kayleigh Wilkerson		Affirmative	N/A
5	Los Angeles Department of Water and Power	Glenn Barry		Affirmative	N/A
5	Lower Colorado River Authority	Teresa Cantwell		Affirmative	N/A
5	Manitoba Hydro	Yuguang Xiao		Affirmative	N/A
5	Massachusetts Municipal Wholesale Electric Company	Anthony Stevens		None	N/A
5	MGE Energy - Madison Gas and Electric Co.	Steven Schultz		None	N/A
5	National Grid USA	Elizabeth Spivak		Negative	Third-Party Comments
5	NaturEner USA, LLC	Eric Smith		Affirmative	N/A
5	NB Power Corporation	Laura McLeod		Affirmative	N/A
5	New York Power Authority	Shivaz Chopra		Affirmative	N/A
5	NextEra Energy	Allen Schriver		Affirmative	N/A
5	NiSource - Northern Indiana Public Service Co.	Kathryn Tackett		Affirmative	N/A
5	North Carolina Electric Membership Corporation	John Cook	Kagen DelRio	Affirmative	N/A
5	Northern California Power Agency	Marty Hostler		None	N/A
5	OGE Energy - Oklahoma Gas and Electric Co.	Patrick Wells		Affirmative	N/A
5	Oglethorpe Power Corporation	Donna Johnson		Affirmative	N/A
5	Omaha Public Power District	Mahmood Safi		Affirmative	N/A

Segment	Organization	Voter	Designated Proxy	Ballot	NERC Memo
5	Ontario Power Generation Inc.	Constantin Chitescu		Negative	Comments Submitted
5	Platte River Power Authority	Tyson Archie		Affirmative	N/A
5	PPL - Louisville Gas and Electric Co.	JULIE HOSTRANDER		Affirmative	N/A
5	PSEG - PSEG Fossil LLC	Tim Kucey		Affirmative	N/A
5	Public Utility District No. 1 of Chelan County	Meaghan Connell		Affirmative	N/A
5	Public Utility District No. 1 of Snohomish County	Sam Nietfeld		Affirmative	N/A
5	Puget Sound Energy, Inc.	Eleanor Ewry		Affirmative	N/A
5	Sacramento Municipal Utility District	Susan Oto	Joe Tarantino	Affirmative	N/A
5	Salt River Project	Kevin Nielsen		Affirmative	N/A
5	Santee Cooper	Tommy Curtis		Affirmative	N/A
5	Seattle City Light	Faz Kasraie		Affirmative	N/A
5	Seminole Electric Cooperative, Inc.	David Weber		None	N/A
5	Sempra - San Diego Gas and Electric	Jennifer Wright		Affirmative	N/A
5	Southern Company - Southern Company Generation	William D. Shultz		Negative	Comments Submitted
5	SunPower	Bradley Collard		Abstain	N/A
5	Tacoma Public Utilities (Tacoma, WA)	Ozan Ferrin		Affirmative	N/A
5	Talen Generation, LLC	Donald Lock		None	N/A
5	U.S. Bureau of Reclamation	Wendy Center		Affirmative	N/A
5	5 - NERC Ver 4.3.0.0 Machine Name: ERODYSB5WB02 Vistra Energy	Dan Roethemeyer		Affirmative	N/A

Segment	Organization	Voter	Designated Proxy	Ballot	NERC Memo
5	WEC Energy Group, Inc.	Linda Horn		Affirmative	N/A
5	Westar Energy	Derek Brown	Douglas Webb	Affirmative	N/A
5	Xcel Energy, Inc.	Gerry Huitt	Amy Casuscelli	Affirmative	N/A
6	AEP - AEP Marketing	Yee Chou		Negative	Comments Submitted
6	Ameren - Ameren Services	Robert Quinlivan		Affirmative	N/A
6	APS - Arizona Public Service Co.	Chinedu Ochonogor		Affirmative	N/A
6	Associated Electric Cooperative, Inc.	Brian Ackermann		None	N/A
6	Berkshire Hathaway - PacifiCorp	Sandra Shaffer		Affirmative	N/A
6	Black Hills Corporation	Eric Scherr		Affirmative	N/A
6	Bonneville Power Administration	Andrew Meyers		Affirmative	N/A
6	Cleco Corporation	Robert Hirschak	Louis Guidry	Affirmative	N/A
6	Con Ed - Consolidated Edison Co. of New York	Christopher Overberg		Affirmative	N/A
6	Dominion - Dominion Resources, Inc.	Sean Bodkin		Negative	Comments Submitted
6	Duke Energy	Greg Cecil		Negative	Comments Submitted
6	Edison International - Southern California Edison Company	Kenya Streeter		None	N/A
6	Exelon	Becky Webb		Affirmative	N/A
6	FirstEnergy - FirstEnergy Solutions	Ann Carey		Affirmative	N/A
6	Florida Municipal Power Agency	Richard Montgomery		Negative	Comments Submitted
6	Florida Municipal Power Pool	Tom Reedy	Brandon McCormick	None	N/A

Segment	Organization	Voter	Designated Proxy	Ballot	NERC Memo
6	Great Plains Energy - Kansas City Power and Light Co.	Jennifer Flandermeyer		Affirmative	N/A
6	Great River Energy	Donna Stephenson	Michael Brytowski	Affirmative	N/A
6	Lakeland Electric	Paul Shipps		None	N/A
6	Lincoln Electric System	Eric Ruskamp		Affirmative	N/A
6	Los Angeles Department of Water and Power	Anton Vu		Affirmative	N/A
6	Manitoba Hydro	Blair Mukanik		Affirmative	N/A
6	MGE Energy - Madison Gas and Electric Co.	Robert Thorson		None	N/A
6	Muscatine Power and Water	Nick Burns		Affirmative	N/A
6	New York Power Authority	Thomas Savin	Shelly Dineen	Affirmative	N/A
6	NextEra Energy - Florida Power and Light Co.	Justin Welty		Affirmative	N/A
6	NiSource - Northern Indiana Public Service Co.	Joe O'Brien		Affirmative	N/A
6	Northern California Power Agency	Dennis Sismaet		Abstain	N/A
6	OGE Energy - Oklahoma Gas and Electric Co.	Sing Tay		Affirmative	N/A
6	Platte River Power Authority	Sabrina Martz		Affirmative	N/A
6	Portland General Electric Co.	Daniel Mason		Affirmative	N/A
6	Powerex Corporation	Gordon Dobson-Mack		None	N/A
6	PPL - Louisville Gas and Electric Co.	Linn Oelker		Affirmative	N/A

Segment	Organization	Voter	Designated Proxy	Ballot	NERC Memo
6	PSEG - PSEG Energy Resources and Trade LLC	Luiggi Beretta		Affirmative	N/A
6	Public Utility District No. 1 of Chelan County	Davis Jelusich		Affirmative	N/A
6	Public Utility District No. 2 of Grant County, Washington	LeRoy Patterson		Affirmative	N/A
6	Sacramento Municipal Utility District	Jamie Cutlip	Joe Tarantino	Affirmative	N/A
6	Santee Cooper	Michael Brown		Affirmative	N/A
6	Seattle City Light	Charles Freeman		Affirmative	N/A
6	Seminole Electric Cooperative, Inc.	David Reinecke		None	N/A
6	Snohomish County PUD No. 1	John Liang		Affirmative	N/A
6	Southern Company - Southern Company Generation	Ron Carlsen		Negative	Comments Submitted
6	Tacoma Public Utilities (Tacoma, WA)	Rick Applegate		Affirmative	N/A
6	Talen Energy Marketing, LLC	Jennifer Hohenshilt		None	N/A
6	Tennessee Valley Authority	Marjorie Parsons		Negative	Third-Party Comments
6	WEC Energy Group, Inc.	David Hathaway		Affirmative	N/A
6	Westar Energy	Grant Wilkerson	Douglas Webb	Affirmative	N/A
6	Xcel Energy, Inc.	Carrie Dixon	Amy Casuscelli	Affirmative	N/A
8	David Kiguel	David Kiguel		Affirmative	N/A
9	Commonwealth of Massachusetts Department of Public Utilities	Donald Nelson		Affirmative	N/A

Segment	Organization	Voter	Designated Proxy	Ballot	NERC Memo
10	Midwest Reliability Organization	Russel Mountjoy		Affirmative	N/A
10	New York State Reliability Council	ALAN ADAMSON		Abstain	N/A
10	Northeast Power Coordinating Council	Guy V. Zito		Affirmative	N/A
10	ReliabilityFirst	Anthony Jablonski		Affirmative	N/A
10	SERC Reliability Corporation	Dave Krueger		Affirmative	N/A
10	Texas Reliability Entity, Inc.	Rachel Coyne		Negative	Comments Submitted
10	Western Electricity Coordinating Council	Steven Rueckert		Affirmative	N/A

Showing 1 to 298 of 298 entries

Previous 1 Next

BALLOT RESULTS

Ballot Name: 2018-04 Modifications to PRC-024-2 PRC-024-3 Non-binding Poll AB 2 NB**Voting Start Date:** 10/25/2019 12:01:00 AM**Voting End Date:** 11/4/2019 8:00:00 PM**Ballot Type:** NB**Ballot Activity:** AB**Ballot Series:** 2**Total # Votes:** 228**Total Ballot Pool:** 281**Quorum:** 81.14**Quorum Established Date:** 11/4/2019 5:05:24 PM**Weighted Segment Value:** 86.46

Segment	Ballot Pool	Segment Weight	Affirmative Votes	Affirmative Fraction	Negative Votes	Negative Fraction	Abstain	No Vote
Segment: 1	67	1	36	0.857	6	0.143	14	11
Segment: 2	7	0.4	4	0.4	0	0	0	3
Segment: 3	71	1	43	0.878	6	0.122	6	16
Segment: 4	17	1	9	0.818	2	0.182	2	4
Segment: 5	65	1	42	0.857	7	0.143	6	10
Segment: 6	46	1	26	0.839	5	0.161	6	9
Segment: 7	0	0	0	0	0	0	0	0
Segment: 8	1	0.1	1	0.1	0	0	0	0
Segment: 9	1	0.1	1	0.1	0	0	0	0
Segment: 10	6	0.4	4	0.4	0	0	2	0

Segment	Ballot Pool	Segment Weight	Affirmative Votes	Affirmative Fraction	Negative Votes	Negative Fraction	Abstain	No Vote
Totals:	281	6	166	5.249	26	0.751	36	53

BALLOT POOL MEMBERS

Show entries

Search:

Segment	Organization	Voter	Designated Proxy	Ballot	NERC Memo
1	AEP - AEP Service Corporation	Dennis Sauriol		Negative	Comments Submitted
1	Ameren - Ameren Services	Eric Scott		Abstain	N/A
1	APS - Arizona Public Service Co.	Michelle Amarantos		Affirmative	N/A
1	Arizona Electric Power Cooperative, Inc.	Ben Engelby		None	N/A
1	Associated Electric Cooperative, Inc.	Mark Riley		None	N/A
1	Avista - Avista Corporation	Mike Magruder		Affirmative	N/A
1	Balancing Authority of Northern California	Kevin Smith	Joe Tarantino	Affirmative	N/A
1	BC Hydro and Power Authority	Adrian Andreoiu		Abstain	N/A
1	Beaches Energy Services	Don Cuevas	Brandon McCormick	None	N/A
1	Bonneville Power Administration	Kammy Rogers-Holliday		Affirmative	N/A

Segment	Organization	Voter	Designated Proxy	Ballot	NERC Memo
1	CenterPoint Energy Houston Electric, LLC	Daniela Hammons		Abstain	N/A
1	Central Electric Power Cooperative (Missouri)	Michael Bax		Affirmative	N/A
1	City Utilities of Springfield, Missouri	Michael Buyce		Affirmative	N/A
1	CMS Energy - Consumers Energy Company	Donald Lynd		Negative	Comments Submitted
1	Colorado Springs Utilities	Mike Braunstein		Affirmative	N/A
1	Con Ed - Consolidated Edison Co. of New York	Dermot Smyth		Affirmative	N/A
1	Dairyland Power Cooperative	Renee Leidel		Abstain	N/A
1	Dominion - Dominion Virginia Power	Candace Marshall		Negative	Comments Submitted
1	Duke Energy	Laura Lee		Negative	Comments Submitted
1	Edison International - Southern California Edison Company	Ayman Samaan		None	N/A
1	Entergy - Entergy Services, Inc.	Oliver Burke		Abstain	N/A
1	Exelon	Daniel Gacek		Affirmative	N/A
1	FirstEnergy - FirstEnergy Corporation	Julie Severino		Affirmative	N/A
1	Gainesville Regional Utilities	David Owens	Brandon McCormick	None	N/A
1	Georgia Transmission Corporation	Greg Davis		Affirmative	N/A
1	Glencoe Light and Power Commission	Terry Volkmann		Affirmative	N/A
1	Great Plains Energy - Kansas City Power and Light Co.	James McBee		Affirmative	N/A

Segment	Organization	Voter	Designated Proxy	Ballot	NERC Memo
1	Great River Energy	Gordon Pietsch		Affirmative	N/A
1	Imperial Irrigation District	Jesus Sammy Alcaraz		Abstain	N/A
1	Lakeland Electric	Larry Watt		None	N/A
1	Lincoln Electric System	Danny Pudenz		Abstain	N/A
1	Los Angeles Department of Water and Power	faranak sarbaz		None	N/A
1	Lower Colorado River Authority	Trey Melcher		None	N/A
1	M and A Electric Power Cooperative	William Price		Affirmative	N/A
1	Manitoba Hydro	Bruce Reimer		None	N/A
1	Muscatine Power and Water	Andy Kurriger		Affirmative	N/A
1	N.W. Electric Power Cooperative, Inc.	Mark Ramsey		Affirmative	N/A
1	National Grid USA	Michael Jones		Negative	Comments Submitted
1	Nebraska Public Power District	Jamison Cawley		Abstain	N/A
1	New York Power Authority	Salvatore Spagnolo		Affirmative	N/A
1	NextEra Energy - Florida Power and Light Co.	Mike O'Neil		Affirmative	N/A
1	NiSource - Northern Indiana Public Service Co.	Steve Toosevich		Affirmative	N/A
1	Northeast Missouri Electric Power Cooperative	Kevin White		Affirmative	N/A
1	OGE Energy - Oklahoma Gas and Electric Co.	Terri Pyle		Affirmative	N/A
1	Orlando Utilities Commission	Aaron Staley		None	N/A

Segment	Organization	Voter	Designated Proxy	Ballot	NERC Memo
1	PPL Electric Utilities Corporation	Brenda Truhe		Abstain	N/A
1	PSEG - Public Service Electric and Gas Co.	Sean Cavote		Abstain	N/A
1	Public Utility District No. 1 of Chelan County	Jeff Kimbell		Affirmative	N/A
1	Public Utility District No. 1 of Snohomish County	Long Duong		Affirmative	N/A
1	Puget Sound Energy, Inc.	Theresa Rakowsky		Affirmative	N/A
1	Sacramento Municipal Utility District	Arthur Starkovich	Joe Tarantino	Affirmative	N/A
1	Salt River Project	Steven Cobb		Affirmative	N/A
1	Santee Cooper	Chris Wagner		Affirmative	N/A
1	SaskPower	Wayne Guttormson		Affirmative	N/A
1	Seattle City Light	Pawel Krupa		Affirmative	N/A
1	Seminole Electric Cooperative, Inc.	Bret Galbraith		None	N/A
1	Sempra - San Diego Gas and Electric	Mo Derbas		Affirmative	N/A
1	Sho-Me Power Electric Cooperative	Peter Dawson		Affirmative	N/A
1	Southern Company - Southern Company Services, Inc.	Adrienne Collins		Negative	Comments Submitted
1	Tacoma Public Utilities (Tacoma, WA)	John Merrell		Affirmative	N/A
1	Tallahassee Electric (City of Tallahassee, FL)	Scott Langston		Abstain	N/A
1	Tennessee Valley Authority	Gabe Kurtz		Abstain	N/A
1	Tri-State G and T Association, Inc.	Kjersti Drott		Abstain	N/A

Segment	Organization	Voter	Designated Proxy	Ballot	NERC Memo
1	U.S. Bureau of Reclamation	Richard Jackson		Affirmative	N/A
1	Unisource - Tucson Electric Power Co.	John Tolo		Affirmative	N/A
1	Westar Energy	Allen Klassen	Douglas Webb	Affirmative	N/A
1	Western Area Power Administration	sean erickson		Abstain	N/A
2	California ISO	Jamie Johnson		Affirmative	N/A
2	Electric Reliability Council of Texas, Inc.	Brandon Gleason		Affirmative	N/A
2	Independent Electricity System Operator	Leonard Kula		Affirmative	N/A
2	Midcontinent ISO, Inc.	Bobbi Welch		None	N/A
2	New York Independent System Operator	Gregory Campoli		None	N/A
2	PJM Interconnection, L.L.C.	Mark Holman		Affirmative	N/A
2	Southwest Power Pool, Inc. (RTO)	Charles Yeung		None	N/A
3	AEP	Kent Feliks		Negative	Comments Submitted
3	AES - Indianapolis Power and Light Co.	Bette White		Affirmative	N/A
3	Ameren - Ameren Services	David Jendras		Abstain	N/A
3	APS - Arizona Public Service Co.	Vivian Moser		Affirmative	N/A
3	Associated Electric Cooperative, Inc.	Todd Bennett		Affirmative	N/A
3	Austin Energy	W. Dwayne Preston		Affirmative	N/A
3	Avista - Avista Corporation	Scott Kinney		Affirmative	N/A

Segment	Organization	Voter	Designated Proxy	Ballot	NERC Memo
3	BC Hydro and Power Authority	Hootan Jarollahi		Abstain	N/A
3	Beaches Energy Services	Steven Lancaster	Brandon McCormick	None	N/A
3	Berkshire Hathaway Energy - MidAmerican Energy Co.	Darnez Gresham		Affirmative	N/A
3	Black Hills Corporation	Eric Egge		Affirmative	N/A
3	Bonneville Power Administration	Ken Lanehome		Affirmative	N/A
3	Central Electric Power Cooperative (Missouri)	Adam Weber		Affirmative	N/A
3	City Utilities of Springfield, Missouri	Scott Williams		Affirmative	N/A
3	CMS Energy - Consumers Energy Company	Karl Blaszkowski		Negative	Comments Submitted
3	Colorado Springs Utilities	Hillary Dobson		Affirmative	N/A
3	Con Ed - Consolidated Edison Co. of New York	Peter Yost		Affirmative	N/A
3	Cowlitz County PUD	Russell Noble		Affirmative	N/A
3	CPS Energy	James Grimshaw		None	N/A
3	Dominion - Dominion Resources, Inc.	Connie Lowe		Negative	Comments Submitted
3	DTE Energy - Detroit Edison Company	Karie Barczak		None	N/A
3	Duke Energy	Lee Schuster		Negative	Comments Submitted
3	Edison International - Southern California Edison Company	Romel Aquino		Affirmative	N/A
3	Eversource Energy	Sharon Flannery		None	N/A
3	Exelon	Kinte Whitehead		Affirmative	N/A

Segment	Organization	Voter	Designated Proxy	Ballot	NERC Memo
3	FirstEnergy - FirstEnergy Corporation	Aaron Ghodooshim		Affirmative	N/A
3	Florida Municipal Power Agency	Dale Ray	Brandon McCormick	None	N/A
3	Gainesville Regional Utilities	Darko Kovac	Brandon McCormick	None	N/A
3	Georgia System Operations Corporation	Scott McGough		Affirmative	N/A
3	Great Plains Energy - Kansas City Power and Light Co.	John Carlson		Affirmative	N/A
3	Great River Energy	Brian Glover		Affirmative	N/A
3	KAMO Electric Cooperative	Tony Gott		Affirmative	N/A
3	Lakeland Electric	Patricia Boody		None	N/A
3	Lincoln Electric System	Jason Fortik		Abstain	N/A
3	Los Angeles Department of Water and Power	Tony Skourtas		Affirmative	N/A
3	M and A Electric Power Cooperative	Stephen Pogue		Affirmative	N/A
3	Manitoba Hydro	Karim Abdel-Hadi		Affirmative	N/A
3	Muscatine Power and Water	Seth Shoemaker		Affirmative	N/A
3	National Grid USA	Brian Shanahan		Negative	Comments Submitted
3	Nebraska Public Power District	Tony Eddleman		Abstain	N/A
3	New York Power Authority	David Rivera		Affirmative	N/A
3	NiSource - Northern Indiana Public Service Co.	Dmitriy Bazylyuk		Affirmative	N/A
3	North Carolina Electric Membership Corporation	doug white		None	N/A

Segment	Organization	Voter	Designated Proxy	Ballot	NERC Memo
3	Northeast Missouri Electric Power Cooperative	Skyler Wiegmann		Affirmative	N/A
3	NW Electric Power Cooperative, Inc.	John Stickley		Affirmative	N/A
3	Ocala Utility Services	Neville Bowen	Brandon McCormick	None	N/A
3	OGE Energy - Oklahoma Gas and Electric Co.	Donald Hargrove		Affirmative	N/A
3	Omaha Public Power District	Aaron Smith		Affirmative	N/A
3	Owensboro Municipal Utilities	Thomas Lyons		Abstain	N/A
3	Platte River Power Authority	Jeff Landis		Affirmative	N/A
3	PNM Resources - Public Service Company of New Mexico	Trevor Tidwell		Affirmative	N/A
3	Portland General Electric Co.	Dan Zollner		Affirmative	N/A
3	PPL - Louisville Gas and Electric Co.	James Frank		None	N/A
3	PSEG - Public Service Electric and Gas Co.	James Meyer		None	N/A
3	Public Utility District No. 1 of Chelan County	Joyce Gundry		Affirmative	N/A
3	Puget Sound Energy, Inc.	Tim Womack		Affirmative	N/A
3	Sacramento Municipal Utility District	Nicole Looney	Joe Tarantino	Affirmative	N/A
3	Salt River Project	Zack Heim		None	N/A
3	Santee Cooper	James Poston		Affirmative	N/A
3	Seminole Electric Cooperative, Inc.	Michael Lee		None	N/A

Segment	Organization	Voter	Designated Proxy	Ballot	NERC Memo
3	Sempra - San Diego Gas and Electric	Bridget Silvia		Affirmative	N/A
3	Sho-Me Power Electric Cooperative	Jeff Neas		Affirmative	N/A
3	Silicon Valley Power - City of Santa Clara	Val Ridad		None	N/A
3	Snohomish County PUD No. 1	Holly Chaney		Affirmative	N/A
3	Southern Company - Alabama Power Company	Joel Dembowski		Negative	Comments Submitted
3	Tacoma Public Utilities (Tacoma, WA)	Marc Donaldson		Affirmative	N/A
3	TECO - Tampa Electric Co.	Ronald Donahey		None	N/A
3	Tennessee Valley Authority	Ian Grant		None	N/A
3	WEC Energy Group, Inc.	Thomas Breene		Affirmative	N/A
3	Westar Energy	Bryan Taggart	Douglas Webb	Affirmative	N/A
3	Xcel Energy, Inc.	Michael Ibold		Abstain	N/A
4	Alliant Energy Corporation Services, Inc.	Larry Heckert		Affirmative	N/A
4	Austin Energy	Jun Hua		None	N/A
4	City Utilities of Springfield, Missouri	John Allen		Affirmative	N/A
4	CMS Energy - Consumers Energy Company	Nicholas Tenney		Negative	Comments Submitted
4	FirstEnergy - FirstEnergy Corporation	Mark Garza		Affirmative	N/A
4	Florida Municipal Power Agency	Carol Chinn		Negative	Comments Submitted

Segment	Organization	Voter	Designated Proxy	Ballot	NERC Memo
4	Georgia System Operations Corporation	Andrea Barclay		Affirmative	N/A
4	Indiana Municipal Power Agency	Jack Alvey	Scott Berry	Abstain	N/A
4	Keys Energy Services	Nick Batty	Brandon McCormick	None	N/A
4	MGE Energy - Madison Gas and Electric Co.	Joseph DePoorter		Abstain	N/A
4	North Carolina Electric Membership Corporation	Luis Fondacci	Kagen DelRio	Affirmative	N/A
4	Public Utility District No. 1 of Snohomish County	John Martinsen		Affirmative	N/A
4	Public Utility District No. 2 of Grant County, Washington	Karla Weaver		None	N/A
4	Sacramento Municipal Utility District	Beth Tincher	Joe Tarantino	Affirmative	N/A
4	Seattle City Light	Hao Li		Affirmative	N/A
4	Tacoma Public Utilities (Tacoma, WA)	Hien Ho		Affirmative	N/A
4	Utility Services, Inc.	Brian Evans-Mongeon		None	N/A
5	AEP	Thomas Foltz		Negative	Comments Submitted
5	AES - AES Corporation	Leo Bernier		None	N/A
5	Ameren - Ameren Missouri	Sam Dwyer		Abstain	N/A
5	APS - Arizona Public Service Co.	Kelsi Rigby		Affirmative	N/A
5	Associated Electric Cooperative, Inc.	Brad Haralson		Affirmative	N/A
5	Austin Energy	Lisa Martin		Affirmative	N/A
5	Avista - Avista Corporation	Glen Farmer		Affirmative	N/A

Segment	Organization	Voter	Designated Proxy	Ballot	NERC Memo
5	Basin Electric Power Cooperative	Mike Kraft		None	N/A
5	Berkshire Hathaway - NV Energy	Kevin Salsbury		Affirmative	N/A
5	Black Hills Corporation	George Tatar		Affirmative	N/A
5	Bonneville Power Administration	Scott Winner		Affirmative	N/A
5	Brazos Electric Power Cooperative, Inc.	Shari Heino		Affirmative	N/A
5	Choctaw Generation Limited Partnership, LLLP	Rob Watson		Negative	Comments Submitted
5	City of Independence, Power and Light Department	Jim Nail		Affirmative	N/A
5	City Water, Light and Power of Springfield, IL	Rick Meadows		None	N/A
5	CMS Energy - Consumers Energy Company	David Greyerbiehl		Negative	Comments Submitted
5	Con Ed - Consolidated Edison Co. of New York	William Winters	Daniel Valle	Affirmative	N/A
5	Cowlitz County PUD	Deanna Carlson		Affirmative	N/A
5	Dairyland Power Cooperative	Tommy Drea		None	N/A
5	Dominion - Dominion Resources, Inc.	Rachel Snead		Negative	Comments Submitted
5	DTE Energy - Detroit Edison Company	Adrian Raducea		None	N/A
5	Duke Energy	Dale Goodwine		Negative	Comments Submitted
5	Edison International - Southern California Edison Company	Neil Shockey		Abstain	N/A
5	Exelon	Cynthia Lee		Affirmative	N/A

Segment	Organization	Voter	Designated Proxy	Ballot	NERC Memo
5	FirstEnergy - FirstEnergy Solutions	Robert Loy		Affirmative	N/A
5	Florida Municipal Power Agency	Chris Gowder		Negative	Comments Submitted
5	Great Plains Energy - Kansas City Power and Light Co.	Marcus Moor		Affirmative	N/A
5	Great River Energy	Preston Walsh		Affirmative	N/A
5	Herb Schrayshuen	Herb Schrayshuen		Affirmative	N/A
5	Imperial Irrigation District	Tino Zaragoza		Abstain	N/A
5	Lakeland Electric	Jim Howard		None	N/A
5	Lincoln Electric System	Kayleigh Wilkerson		Abstain	N/A
5	Los Angeles Department of Water and Power	Glenn Barry		Affirmative	N/A
5	Lower Colorado River Authority	Teresa Cantwell		Affirmative	N/A
5	Manitoba Hydro	Yuguang Xiao		Affirmative	N/A
5	Massachusetts Municipal Wholesale Electric Company	Anthony Stevens		None	N/A
5	NaturEner USA, LLC	Eric Smith		Affirmative	N/A
5	NB Power Corporation	Laura McLeod		Affirmative	N/A
5	New York Power Authority	Shivaz Chopra		Affirmative	N/A
5	NextEra Energy	Allen Schriver		Affirmative	N/A
5	NiSource - Northern Indiana Public Service Co.	Kathryn Tackett		Affirmative	N/A
5	North Carolina Electric Membership Corporation	John Cook	Kagen DelRio	Affirmative	N/A

Segment	Organization	Voter	Designated Proxy	Ballot	NERC Memo
5	Northern California Power Agency	Marty Hostler		None	N/A
5	OGE Energy - Oklahoma Gas and Electric Co.	Patrick Wells		Affirmative	N/A
5	Oglethorpe Power Corporation	Donna Johnson		Affirmative	N/A
5	Omaha Public Power District	Mahmood Safi		Affirmative	N/A
5	Ontario Power Generation Inc.	Constantin Chitescu		Affirmative	N/A
5	Platte River Power Authority	Tyson Archie		Affirmative	N/A
5	PPL - Louisville Gas and Electric Co.	JULIE HOSTRANDER		None	N/A
5	PSEG - PSEG Fossil LLC	Tim Kucey		Abstain	N/A
5	Public Utility District No. 1 of Chelan County	Meaghan Connell		Affirmative	N/A
5	Public Utility District No. 1 of Snohomish County	Sam Nietfeld		Affirmative	N/A
5	Puget Sound Energy, Inc.	Eleanor Ewry		Affirmative	N/A
5	Sacramento Municipal Utility District	Susan Oto	Joe Tarantino	Affirmative	N/A
5	Salt River Project	Kevin Nielsen		Affirmative	N/A
5	Santee Cooper	Tommy Curtis		Affirmative	N/A
5	Seattle City Light	Faz Kasraie		Affirmative	N/A
5	Seminole Electric Cooperative, Inc.	David Weber		None	N/A
5	Sempra - San Diego Gas and Electric	Jennifer Wright		Affirmative	N/A
5	Southern Company - Southern Company Generation	William D. Shultz		Negative	Comments Submitted

Segment	Organization	Voter	Designated Proxy	Ballot	NERC Memo
5	SunPower	Bradley Collard		Abstain	N/A
5	Tacoma Public Utilities (Tacoma, WA)	Ozan Ferrin		Affirmative	N/A
5	U.S. Bureau of Reclamation	Wendy Center		Affirmative	N/A
5	Vistra Energy	Dan Roethemeyer		Affirmative	N/A
5	Westar Energy	Derek Brown	Douglas Webb	Affirmative	N/A
6	AEP - AEP Marketing	Yee Chou		Negative	Comments Submitted
6	Ameren - Ameren Services	Robert Quinlivan		Abstain	N/A
6	APS - Arizona Public Service Co.	Chinedu Ochonogor		Affirmative	N/A
6	Associated Electric Cooperative, Inc.	Brian Ackermann		None	N/A
6	Berkshire Hathaway - PacifiCorp	Sandra Shaffer		Affirmative	N/A
6	Black Hills Corporation	Eric Scherr		Affirmative	N/A
6	Bonneville Power Administration	Andrew Meyers		Affirmative	N/A
6	Cleco Corporation	Robert Hirschak	Louis Guidry	Affirmative	N/A
6	Con Ed - Consolidated Edison Co. of New York	Christopher Overberg		Affirmative	N/A
6	Dominion - Dominion Resources, Inc.	Sean Bodkin		Negative	Comments Submitted
6	Duke Energy	Greg Cecil		Negative	Comments Submitted
6	Edison International - Southern California Edison Company	Kenya Streeter		None	N/A
6	Exelon	Becky Webb		Affirmative	N/A
6	FirstEnergy - FirstEnergy Solutions	Ann Carey		Affirmative	N/A

Segment	Organization	Voter	Designated Proxy	Ballot	NERC Memo
6	Florida Municipal Power Agency	Richard Montgomery		Negative	Comments Submitted
6	Florida Municipal Power Pool	Tom Reedy	Brandon McCormick	None	N/A
6	Great Plains Energy - Kansas City Power and Light Co.	Jennifer Flandermeyer		Affirmative	N/A
6	Great River Energy	Donna Stephenson	Michael Brytowski	Affirmative	N/A
6	Lakeland Electric	Paul Shipps		None	N/A
6	Lincoln Electric System	Eric Ruskamp		Abstain	N/A
6	Los Angeles Department of Water and Power	Anton Vu		Affirmative	N/A
6	Manitoba Hydro	Blair Mukanik		Affirmative	N/A
6	MGE Energy - Madison Gas and Electric Co.	Robert Thorson		None	N/A
6	Muscatine Power and Water	Nick Burns		Affirmative	N/A
6	New York Power Authority	Thomas Savin	Shelly Dineen	Affirmative	N/A
6	NextEra Energy - Florida Power and Light Co.	Justin Welty		Affirmative	N/A
6	NiSource - Northern Indiana Public Service Co.	Joe O'Brien		Affirmative	N/A
6	Northern California Power Agency	Dennis Sismaet		Abstain	N/A
6	OGE Energy - Oklahoma Gas and Electric Co.	Sing Tay		Affirmative	N/A
6	Portland General Electric Co.	Daniel Mason		Abstain	N/A
6	Powerex Corporation	Gordon Dobson-Mack		None	N/A

Segment	Organization	Voter	Designated Proxy	Ballot	NERC Memo
6	PPL - Louisville Gas and Electric Co.	Linn Oelker		None	N/A
6	PSEG - PSEG Energy Resources and Trade LLC	Luiggi Beretta		Abstain	N/A
6	Public Utility District No. 1 of Chelan County	Davis Jelusich		Affirmative	N/A
6	Public Utility District No. 2 of Grant County, Washington	LeRoy Patterson		Affirmative	N/A
6	Sacramento Municipal Utility District	Jamie Cutlip	Joe Tarantino	Affirmative	N/A
6	Santee Cooper	Michael Brown		Affirmative	N/A
6	Seattle City Light	Charles Freeman		Affirmative	N/A
6	Seminole Electric Cooperative, Inc.	David Reinecke		None	N/A
6	Snohomish County PUD No. 1	John Liang		Affirmative	N/A
6	Southern Company - Southern Company Generation	Ron Carlsen		Negative	Comments Submitted
6	Tacoma Public Utilities (Tacoma, WA)	Rick Applegate		Affirmative	N/A
6	Talen Energy Marketing, LLC	Jennifer Hohenshilt		None	N/A
6	Tennessee Valley Authority	Marjorie Parsons		Abstain	N/A
6	WEC Energy Group, Inc.	David Hathaway		Affirmative	N/A
6	Westar Energy	Grant Wilkerson	Douglas Webb	Affirmative	N/A
8	David Kiguel	David Kiguel		Affirmative	N/A
9	Commonwealth of Massachusetts Department of Public Utilities	Donald Nelson		Affirmative	N/A

Segment	Organization	Voter	Designated Proxy	Ballot	NERC Memo
10	Midwest Reliability Organization	Russel Mountjoy		Affirmative	N/A
10	New York State Reliability Council	ALAN ADAMSON		Abstain	N/A
10	Northeast Power Coordinating Council	Guy V. Zito		Affirmative	N/A
10	ReliabilityFirst	Anthony Jablonski		Affirmative	N/A
10	SERC Reliability Corporation	Dave Krueger		Affirmative	N/A
10	Western Electricity Coordinating Council	Steven Rueckert		Abstain	N/A

Showing 1 to 281 of 281 entries

Previous

1

Next

Standards Announcement

Project 2018-04 Modifications to PRC-024-2

Formal Comment Period Open through November 4, 2019

[Now Available](#)

A 45-day comment period for **PRC-024-3 – Generator Frequency and Voltage Protection Settings** is open until **8 p.m. Eastern, Monday, November 4, 2019**.

Commenting

Use the [Standards Balloting and Commenting System \(SBS\)](#) to submit comments. If you experience issues using the SBS, contact [Wendy Muller](#). An unofficial Word version of the comment form is posted on the [project page](#).

- Contact NERC IT support directly at <https://support.nerc.net/> (Monday-Friday, 8 a.m. - 5 p.m. Eastern) for problems regarding accessing the SBS due to a forgotten password, incorrect credential error messages, or system lock-out.
- Passwords expire every **6 months** and must be reset.
- The SBS is **not** supported for use on mobile devices.
- Please be mindful of ballot and comment period closing dates. We ask to **allow at least 48 hours** for NERC support staff to assist with inquiries. Therefore, it is recommended that users try logging into their SBS accounts **prior to the last day** of a comment/ballot period.

Next Steps

A 10-day additional ballot for the standard and a non-binding poll of the associated Violation Risk Factors and Violation Severity Levels, will be conducted **October 25 - November 4, 2019**.

For information on the Standards Development Process, refer to the [Standard Processes Manual](#).

[Subscribe to this project's observer mailing list](#) by selecting "NERC Email Distribution Lists" from the "Applications" drop-down menu and specify "Project 2018-04 Modifications to PRC-024-2 Observer List" in the Description Box. For more information or assistance, contact Standards Developer, [Mat Bunch](#) (via email) or at (404) 446-9785.

North American Electric Reliability Corporation
3353 Peachtree Rd, NE
Suite 600, North Tower
Atlanta, GA 30326
404-446-2560 | www.nerc.com

Comment Report

Project Name: 2018-04 Modifications to PRC-024-2 | PRC-024-3 (Draft 2)
Comment Period Start Date: 9/20/2019
Comment Period End Date: 11/4/2019
Associated Ballots: 2018-04 Modifications to PRC-024-2 PRC-024-3 AB 2 ST

There were 49 sets of responses, including comments from approximately 140 different people from approximately 106 companies representing 10 of the Industry Segments as shown in the table on the following pages.

Questions

- 1. Based on industry feedback, the SDT removed the Transmission Owner (TO) from the Applicability (Functional Entities) of PRC-024-3. Do you agree with this change? If not, please provide the basis for your disagreement and a specific instance where not including the TO would present a risk to reliability.**
- 2. Based on industry feedback, the SDT modified the Applicability (Facilities) to clarify both the types of 'protection' applicable, if activated, and the specific equipment the 'protection' is applied on. Do you agree with these changes? If not, please provide the basis for your disagreement and an alternate solution.**
- 3. To address Scope Item 'f' from the approved SAR, the SDT added an exemption to the Applicability (Facilities) to clarify that all auxiliary equipment and associated protection(s) within the generating Facility are not applicable to the standard. Do you agree with the 'Exemption'? If not, please provide the basis for your disagreement and an alternate solution.**
- 4. Based on industry feedback, the SDT replaced the 0.1 second 'Minimum Time (Sec)' value in the frequency tables with "Instantaneous" and provided additional clarity via Footnote #6 regarding frequency calculation/measurement. Do you agree with this change? If not, please provide the basis for your disagreement and an alternate solution.**
- 5. Based on industry feedback, the SDT revised the Implementation Plan to provide twenty-four months for applicable entities to evaluate settings, make changes for applicable equipment, and purchase necessary equipment, if necessary. Do you agree with the revised Implementation Plan? If not, please provide the basis for your disagreement and an alternate proposal.**
- 6. Do you agree that the proposed modifications provide a cost-effective means of addressing issues identified in the SAR? If not, please provide an alternative, more cost-effective manner in which to achieve at least an equivalent level of reliability.**

Organization Name	Name	Segment(s)	Region	Group Name	Group Member Name	Group Member Organization	Group Member Segment(s)	Group Member Region
Florida Municipal Power Agency	Chris Gowder	5	FRCC	FMPA	Carol Chinn	Florida Municipal Power Agency	4	SERC
					Richard Montgomery	Florida Municipal Power Agency	6	SERC
					Michelle Johnson	Florida Municipal Power Agency	3	SERC
					Don Cuevas	Beaches Energy Services	1	SERC
					David Owens	Gainesville Regional Utilities	1	SERC
					Steven Lancaster	Beaches Energy Services	3	SERC
					Darko Kovac	Gainesville Regional Utilities	3	SERC
					Neville Bowen	Ocala Utility Services	3	SERC
					Nick Batty	Keys Energy Services	4	SERC
					Tom Reedy	Florida Municipal Power Pool	6	SERC
Santee Cooper	Chris Wagner	1		Santee Cooper	Rene' Free	Santee Cooper	1,3,5,6	SERC
					Debbie Schneider	Santee Cooper	1,3,5,6	SERC
					Bridget Coffman	Santee Cooper	1,3,5,6	SERC
MRO	Dana Klem	1,2,3,4,5,6	MRO	MRO NSRF	Joseph DePoorter	Madison Gas & Electric	3,4,5,6	MRO
					Larry Heckert	Alliant Energy	4	MRO
					Michael Brytowski	Great River Energy	1,3,5,6	MRO

					Jodi Jensen	Western Area Power Administration	1,6	MRO
					Andy Crooks	SaskPower Corporation	1	MRO
					Bryan Sherrow	Kansas City Board of Public Utilities	1	MRO
					David Heins	Omaha Public Power District	1,3,5,6	MRO
					Jeremy Voll	Basin Electric Power Cooperative	1	MRO
					David Zwergel	Midcontinent ISO	2	MRO
					Douglas Webb	Kansas City Power & Light	1,3,5,6	MRO
					Fred Meyer	Algonquin Power Co.	1	MRO
					James Nail	Independence Power & Light (Independence Missouri)	1,3,5	MRO
					James Williams	Southwest Power Pool, Inc.	2	MRO
					Jamie Monette	Minnesota Power / ALLETE	1	MRO
					Jamison Cawley	Nebraska Public Power	1,3,5	MRO
					Sing Tay	Oklahoma Gas & Electric	1,3,5,6	MRO
					Terry Harbour	MidAmerican Energy	1,3	MRO
					Troy Brumfield	American Transmission Company	1	MRO
Public Utility District No. 1 of Chelan County	Davis Jelusich	6		Public Utility District No. 1 of Chelan County	Joyce Gundry	Public Utility District No. 1 of Chelan County	3	WECC
					Jeff Kimbell	Public Utility District No. 1 of Chelan County	1	WECC

					Meaghan Connell	Public Utility District No. 1 of Chelan County	5	WECC
					Davis Jelusich	Public Utility District No. 1 of Chelan County	6	WECC
Douglas Webb	Douglas Webb		MRO,SPP RE	Westar-KCPL	Doug Webb	Westar	1,3,5,6	MRO
					Doug Webb	KCP&L	1,3,5,6	MRO
ACES Power Marketing	Jodirah Green	1,3,4,5,6	MRO,NA - Not Applicable,RF,SERC,Texas RE,WECC	ACES Standard Collaborations	Bob Solomon	Hoosier Energy Rural Electric Cooperative, Inc.	1	SERC
					Kevin Lyons	Central Iowa Power Cooperative	1	MRO
					Bill Hutchison	Southern Illinois Power Cooperative	1	SERC
					Tara Lightner	Sunflower Electric Power Corporation	1	MRO
					Jenny Knernshield	Old Dominion Electric Cooperative	3,4	SERC
DTE Energy - Detroit Edison Company	Karie Barczak	3		DTE Energy - DTE Electric	Jeffrey Depriest	DTE Energy - DTE Electric	5	RF
					Daniel Herring	DTE Energy - DTE Electric	4	RF
					Karie Barczak	DTE Energy - DTE Electric	3	RF
Duke Energy	Kim Thomas	1,3,5,6	FRCC,RF,SERC	Duke Energy	Laura Lee	Duke Energy	1	SERC
					Dale Goodwine	Duke Energy	5	SERC
					Greg Cecil	Duke Energy	6	RF
FirstEnergy - FirstEnergy Corporation	Mark Garza	4		FE Voter	Julie Severino	FirstEnergy - FirstEnergy Corporation	1	RF
					Aaron Ghodooshim	FirstEnergy - FirstEnergy Corporation	3	RF

					Robert Loy	FirstEnergy - FirstEnergy Solutions	5	RF
					Ann Carey	FirstEnergy - FirstEnergy Solutions	6	RF
					Mark Garza	FirstEnergy-FirstEnergy	4	RF
Southern Company - Southern Company Services, Inc.	Pamela Hunter	1,3,5,6	SERC	Southern Company	Adrienne Collins	Southern Company - Southern Company Services, Inc.	1	SERC
					Joel Dembowski	Southern Company - Alabama Power Company	3	SERC
					William D. Shultz	Southern Company Generation	5	SERC
					Ron Carlsen	Southern Company - Southern Company Generation	6	SERC
Northeast Power Coordinating Council	Ruida Shu	1,2,3,4,5,6,7,8,9,10	NPCC	RSC	Guy V. Zito	Northeast Power Coordinating Council	10	NPCC
					Randy MacDonald	New Brunswick Power	2	NPCC
					Glen Smith	Entergy Services	4	NPCC
					Brian Robinson	Utility Services	5	NPCC
					Alan Adamson	New York State Reliability Council	7	NPCC
					David Burke	Orange & Rockland Utilities	3	NPCC
					Michele Tondalo	UI	1	NPCC

Helen Lainis	IESO	2	NPCC
Sean Cavote	PSEG	4	NPCC
Kathleen Goodman	ISO-NE	2	NPCC
David Kiguel	Independent	NA - Not Applicable	NPCC
Silvia Mitchell	NextEra Energy - Florida Power and Light Co.	6	NPCC
Paul Malozewski	Hydro One Networks, Inc.	3	NPCC
Nick Kowalczyk	Orange and Rockland	1	NPCC
Joel Charlebois	AESI - Acumen Engineered Solutions International Inc.	5	NPCC
Mike Cooke	Ontario Power Generation, Inc.	4	NPCC
Salvatore Spagnolo	New York Power Authority	1	NPCC
Shivaz Chopra	New York Power Authority	5	NPCC
Mike Forte	Con Ed - Consolidated Edison	4	NPCC
Dermot Smyth	Con Ed - Consolidated Edison Co. of New York	1	NPCC
Peter Yost	Con Ed - Consolidated Edison Co. of New York	3	NPCC
Ashmeet Kaur	Con Ed - Consolidated Edison	5	NPCC
Caroline Dupuis	Hydro Quebec	1	NPCC

					Chantal Mazza	Hydro Quebec	2	NPCC
					Sean Bodkin	Dominion - Dominion Resources, Inc.	6	NPCC
					Laura McLeod	NB Power Corporation	5	NPCC
					Randy MacDonald	NB Power Corporation	2	NPCC
					Gregory Campoli	New York Independent System Operator	2	NPCC
					John Hastings	National Grid	1	NPCC
					Quintin Lee	Eversource Energy	1	NPCC
					Michael Jones	National Grid USA	1	NPCC
Dominion - Dominion Resources, Inc.	Sean Bodkin	6		Dominion	Connie Lowe	Dominion - Dominion Resources, Inc.	3	NA - Not Applicable
					Lou Oberski	Dominion - Dominion Resources, Inc.	5	NA - Not Applicable
					Larry Nash	Dominion - Dominion Virginia Power	1	NA - Not Applicable
					Rachel Snead	Dominion - Dominion Resources, Inc.	5	NA - Not Applicable

1. Based on industry feedback, the SDT removed the Transmission Owner (TO) from the Applicability (Functional Entities) of PRC-024-3. Do you agree with this change? If not, please provide the basis for your disagreement and a specific instance where not including the TO would present a risk to reliability.

Dennis Chastain - Tennessee Valley Authority - 1,3,5,6 - SERC

Answer No

Document Name

Comment

How does it make sense that GSUs owned by GOs are in scope, but GSUs owned by TOs are not? Are GSUs owned by TOs less of a risk to the BES?

Likes 0

Dislikes 0

Response

Kim Thomas - Duke Energy - 1,3,5,6 - SERC,RF, Group Name Duke Energy

Answer No

Document Name

Comment

Some Transmission Owners (TO) apply voltage and frequency trip settings at the Point of Interconnection that trip generation based on PRC-024 voltage and frequency requirements, particularly for inverter-based resources tapped onto network transmission lines. These TO's typically have the same functionality applied by the Generator Owner (GO). This arrangement would suggest that both the GO and TO should comply with PRC-024. If the TO is not required to comply with PRC-024, it could trip a generating plant quicker than required by PRC-024.

Likes 0

Dislikes 0

Response

Rachel Coyne - Texas Reliability Entity, Inc. - 10

Answer No

Document Name

Comment

Although it is uncommon for the TO to own the generator step-up (GSU) or main power transformer (MPT), in cases where to TO does own the GSU or MPT the TO should be required to take steps to ensure the generator rides through voltage and frequency excursions as prescribed within the Standard.

Likes 0

Dislikes 0

Response

Marty Hostler - Northern California Power Agency - 5

Answer

No

Document Name

Comment

Why are TO's GSU protection not included but GO's GSUs are? Also see DUKE, and TRE.

Likes 0

Dislikes 0

Response

Michelle Amarantos - APS - Arizona Public Service Co. - 1

Answer

Yes

Document Name

Comment

AZPS appreciates that this was changed.

Likes 0

Dislikes 0

Response

Dana Klem - MRO - 1,2,3,4,5,6 - MRO, Group Name MRO NSRF

Answer

Yes

Document Name

Comment

The NSRF has concerns with the term “main power transformer (MPT)”. This term is not included in the NERC Glossary of Terms, nor is it well defined in this proposed revision to PRC-024-3. It is introduced as a part of the inclusion of the TO Functional Entity requirement limited to the Quebec Interconnection, yet it is included in the text of Requirement 2 as well as Attachment 2, applicable to the Eastern, Western, and ERCOT Interconnections in the United States. The NSRF requests that the inclusion of this new term in this Standard be reversed, or a formal definition of the term be provided in the Standard or NERC Glossary of Terms.

Likes 1	Alliant Energy Corporation Services, Inc., 4, Heckert Larry
---------	---

Dislikes 0	
------------	--

Response

Maryanne Darling-Reich - Black Hills Corporation - 1,3,5,6 - MRO,WECC

Answer	Yes
---------------	-----

Document Name	
----------------------	--

Comment

BHC agrees with EEI’s comments as submitted

Likes 0	
---------	--

Dislikes 0	
------------	--

Response

Aaron Cavanaugh - Bonneville Power Administration - 1,3,5,6 - WECC

Answer	Yes
---------------	-----

Document Name	
----------------------	--

Comment

BPA is supportive of the proposed change. BPA would like to point out for consideration that this change could possibly be creating a loophole under the following scenario.

If a Generator Owner installs a GSU on a new project that does not meet the requirements outlined in the standard, they could potentially decide with a Transmission Owner, to make the ownership change on the low side, essentially giving the GSU to a non-Quebec Transmission Owner.

If this scenario played out, would the non-Quebec Transmission Owner not need to consider the protection of that GSU for this standard?

Perhaps this is a far-fetched scenario but it was a thought that came to mind regarding this change. The BPA subject matter experts that reviewed this standard do not see this hypothetical loophole as a measurable risk to reliability that would justify a disagreement with the change. BPA only wants to share the thought for others to consider.

Likes 0	
---------	--

Dislikes 0	
------------	--

Response

Glen Farmer - Avista - Avista Corporation - 5

Answer Yes

Document Name

Comment

agree with EEI Comments.

Likes 0

Dislikes 0

Response

Glenn Barry - Los Angeles Department of Water and Power - 5

Answer Yes

Document Name

Comment

There is concern for addressing frequency protection settings for inerties on transmission lines. Because PRC-024 applies to generating resources, should this concern be addressed in PRC-024 or in a separate Standard?

Likes 0

Dislikes 0

Response

Mark Gray - Edison Electric Institute - NA - Not Applicable - NA - Not Applicable

Answer Yes

Document Name

Comment

EEI supports the removal of Transmission Owners (TOs) from the Applicability Section of this Reliability Standard believing that this change is consistent with the purpose of the standard and how TOs operate throughout the US.

Likes 0

Dislikes 0

Response

Douglas Webb - Douglas Webb On Behalf of: Allen Klassen, Westar Energy, 6, 3, 1, 5; Bryan Taggart, Westar Energy, 6, 3, 1, 5; Derek Brown, Westar Energy, 6, 3, 1, 5; Grant Wilkerson, Westar Energy, 6, 3, 1, 5; James McBee, Great Plains Energy - Kansas City Power and Light Co., 1, 3, 6, 5; Jennifer Flandermeyer, Great Plains Energy - Kansas City Power and Light Co., 1, 3, 6, 5; John Carlson, Great Plains Energy - Kansas City Power and Light Co., 1, 3, 6, 5; Marcus Moor, Great Plains Energy - Kansas City Power and Light Co., 1, 3, 6, 5; - Douglas Webb, Group Name Westar-KCPL

Answer Yes

Document Name

Comment

Westar Energy and Kansas City Power & Light support the Edison Electric Institutes (EEI) Comments.

Likes 0

Dislikes 0

Response

Larry Heckert - Alliant Energy Corporation Services, Inc. - 4

Answer Yes

Document Name

Comment

Support the MRO NSRF Comments, as follows:

The NSRF has concerns with the term “main power transformer (MPT)”. This term is not included in the NERC Glossary of Terms, nor is it well defined in this proposed revision to PRC-024-3. It is introduced as a part of the inclusion of the TO Functional Entity requirement limited to the Quebec Interconnection, yet it is included in the text of Requirement 2 as well as Attachment 2, applicable to the Eastern, Western, and ERCOT Interconnections in the United States. The NSRF requests that the inclusion of this new term in this Standard be reversed, or a formal definition of the term be provided in the Standard or NERC Glossary of Terms.

Likes 0

Dislikes 0

Response

Chantal Mazza - Hydro-Quebec TransEnergie - 2 - NPCC

Answer Yes

Document Name [PRC-024-3 HQ comments.docx](#)

Comment

Hydro-Quebec supports the comments submitted by the RSC.

In addition, Hydro-Quebec has the following comments :

- Review and clarify footnote #4 associated with Requirement #3. The last part that was added regarding the protection imbedded in control systems for IBRs brings some confusion as it relates to the protection system itself while the first part of the sentence relates to the equipment that is protected: "Excludes limitations caused by the setting capability of the frequency and voltage protective relays for the generating resource(s) but does not exclude limitations originating in the equipment protected by the relays or frequency and voltage protection embedded in control systems."
- In Attachment 1, we recommend adding the distinct over frequency requirement (curve) that currently applies to thermal generation and IBRs in the Quebec Interconnection . Please see attached file.

Likes 0

Dislikes 0

Response

Daniel Gacek - Exelon - 1

Answer

Yes

Document Name

Comment

Exelon supports the SDTs decision to limit applicability to functional entities that apply the protection systems that are the subject of the standard.

On behalf of Exelon, Segments 1, 3, 5, 6

Likes 0

Dislikes 0

Response

Wayne Guttormson - SaskPower - 1

Answer

Yes

Document Name

Comment

Support the MRO NSRF comments.

Likes 0

Dislikes 0

Response

Matthew Nutsch - Seattle City Light - 1,3,4,5,6 - WECC

Answer

Yes

Document Name

Comment

Likes 0

Dislikes 0

Response

Chris Wagner - Santee Cooper - 1, Group Name Santee Cooper

Answer

Yes

Document Name

Comment

Likes 0

Dislikes 0

Response

Bette White - AES - Indianapolis Power and Light Co. - 3

Answer

Yes

Document Name

Comment

Likes 0

Dislikes 0

Response

Jeanne Kurzynowski - CMS Energy - Consumers Energy Company - 1,3,4,5 - RF

Answer

Yes

Document Name	
Comment	
Likes 0	
Dislikes 0	
Response	
Leonard Kula - Independent Electricity System Operator - 2	
Answer	Yes
Document Name	
Comment	
Likes 0	
Dislikes 0	
Response	
Anthony Jablonski - ReliabilityFirst - 10	
Answer	Yes
Document Name	
Comment	
Likes 0	
Dislikes 0	
Response	
Thomas Foltz - AEP - 5	
Answer	Yes
Document Name	
Comment	
Likes 0	
Dislikes 0	

Response

Kevin Conway - Public Utility District No. 1 of Pend Oreille County - 1,3,5,6

Answer Yes

Document Name

Comment

Likes 0

Dislikes 0

Response

Bridget Silvia - Sempra - San Diego Gas and Electric - 3

Answer Yes

Document Name

Comment

Likes 0

Dislikes 0

Response

Mark Garza - FirstEnergy - FirstEnergy Corporation - 4, Group Name FE Voter

Answer Yes

Document Name

Comment

Likes 0

Dislikes 0

Response

Karl Blaszkowski - CMS Energy - Consumers Energy Company - 3

Answer Yes

Document Name

Comment

Likes 0

Dislikes 0

Response

Amy Casuscelli - Amy Casuscelli On Behalf of: Carrie Dixon, Xcel Energy, Inc. , 6; Gerry Huitt, Xcel Energy, Inc., 1, 5, 3; - Amy Casuscelli

Answer

Yes

Document Name

Comment

Likes 0

Dislikes 0

Response

Donald Lynd - CMS Energy - Consumers Energy Company - 1

Answer

Yes

Document Name

Comment

Likes 0

Dislikes 0

Response

Davis Jelusich - Public Utility District No. 1 of Chelan County - 6, Group Name Public Utility District No. 1 of Chelan County

Answer

Yes

Document Name

Comment

Likes 0

Dislikes 0

Response

Neil Swearingen - Salt River Project - 1,3,5,6 - WECC

Answer Yes

Document Name

Comment

Likes 0

Dislikes 0

Response

Richard Jackson - U.S. Bureau of Reclamation - 1

Answer Yes

Document Name

Comment

Likes 0

Dislikes 0

Response

Siddharth Pant - GE - General Electric Power Systems - NA - Not Applicable - NA - Not Applicable

Answer Yes

Document Name

Comment

Likes 0

Dislikes 0

Response

Jamie Monette - Allete - Minnesota Power, Inc. - 1

Answer Yes

Document Name

Comment

Likes 0

Dislikes 0

Response

Nick Batty - Keys Energy Services - 9 - SERC

Answer

Yes

Document Name

Comment

Likes 0

Dislikes 0

Response

Sean Bodkin - Dominion - Dominion Resources, Inc. - 6, Group Name Dominion

Answer

Yes

Document Name

Comment

Likes 0

Dislikes 0

Response

Bruce Reimer - Manitoba Hydro - 1

Answer

Yes

Document Name

Comment

Likes 0

Dislikes 0

Response

Armin Klusman - CenterPoint Energy Houston Electric, LLC - 1 - WECC

Answer Yes

Document Name

Comment

Likes 0

Dislikes 0

Response

Ruida Shu - Northeast Power Coordinating Council - 1,2,3,4,5,6,7,8,9,10 - NPCC, Group Name RSC

Answer Yes

Document Name

Comment

Likes 0

Dislikes 0

Response

Karie Barczak - DTE Energy - Detroit Edison Company - 3, Group Name DTE Energy - DTE Electric

Answer Yes

Document Name

Comment

Likes 0

Dislikes 0

Response

Jodirah Green - ACES Power Marketing - 1,3,4,5,6 - MRO,WECC,Texas RE,SERC,RF, Group Name ACES Standard Collaborations

Answer Yes

Document Name

Comment

Likes 0

Dislikes 0

Response

Constantin Chitescu - Ontario Power Generation Inc. - 5

Answer Yes

Document Name

Comment

Likes 0

Dislikes 0

Response

Chris Gowder - Florida Municipal Power Agency - 5, Group Name FMPA

Answer Yes

Document Name

Comment

Likes 0

Dislikes 0

Response

Trevor Tidwell - PNM Resources - Public Service Company of New Mexico - 3

Answer Yes

Document Name

Comment

Likes 0

Dislikes 0

Response

Pamela Hunter - Southern Company - Southern Company Services, Inc. - 1,3,5,6 - SERC, Group Name Southern Company

Answer	Yes
Document Name	
Comment	
Likes 0	
Dislikes 0	
Response	
Teresa Cantwell - Lower Colorado River Authority - 5	
Answer	Yes
Document Name	
Comment	
Likes 0	
Dislikes 0	
Response	
Line Dufour - Hydro-Quebec Production - 6 - NPCC	
Answer	
Document Name	
Comment	
N/A, For Quebec interconnection, TO is still part of the standards	
Likes 0	
Dislikes 0	
Response	

2. Based on industry feedback, the SDT modified the Applicability (Facilities) to clarify both the types of 'protection' applicable, if activated, and the specific equipment the 'protection' is applied on. Do you agree with these changes? If not, please provide the basis for your disagreement and an alternate solution.

Pamela Hunter - Southern Company - Southern Company Services, Inc. - 1,3,5,6 - SERC, Group Name Southern Company

Answer No

Document Name

Comment

Paragraph 4.2.1.5 includes items not included in the BES definition document and should not be included in the scope of PRC-024. Paragraph 4.2.1.4 should be the limit of the scope of equipment covered by PRC-024 for inverter-based resources.

Likes 0

Dislikes 0

Response

Chris Gowder - Florida Municipal Power Agency - 5, Group Name FMMPA

Answer No

Document Name

Comment

1. Main Power Transformer (MPT)- not defined anywhere. The intent was to replace "collector transformer", but MPT is no better without context. Also, the term is defined in the Quebec-only language, then used in NERC-wide language.
2. Footnote seems to be adding unnecessary complexity.
3. Use of term capacity in the facility definition will lead to confusion, should just refer to BES definition Inclusion I4.

Likes 0

Dislikes 0

Response

Constantin Chitescu - Ontario Power Generation Inc. - 5

Answer No

Document Name

Comment

The terms "cease injecting current", "cease current injection" and "momentary cessation" are not defined, nor commonly understood.

Significant reduction of the amount of current being injected has a similar effect to momentary current cessation; they both deprive the grid of much needed support during the disturbance which negatively impacts grid reliability, and therefore, should not be an option, nor allowed without approval.

Understanding the compounded effect on the grid of a multitude of inverters having similar design is important and accurate modelling may not be possible without adequate information regarding the amount of current being reduced.

OPG recommends the terms “cease injecting current”, “cease current injection” and “momentary cessation”, used throughout the standard (applicable Facilities 4.2.1, R1, R2, applicable protection definition per footnote 3, D.A.2, Attachment 2a, etc.), to be replaced with “ceasing injecting current or significant reduction in current injection”.

If this comment is adopted and implemented as such then there is a need to define the term “significant”.

Likes 0

Dislikes 0

Response

Marty Hostler - Northern California Power Agency - 5

Answer

No

Document Name

Comment

See AEP, Duke, and TRE comments.

Likes 0

Dislikes 0

Response

Armin Klusman - CenterPoint Energy Houston Electric, LLC - 1 - WECC

Answer

No

Document Name

Comment

CenterPoint Energy Houston Electric, LLC (CenterPoint Energy) disagrees with changing “collector transformer” to a newly developed term of “main power transformer (MPT)”. The use of “power” in the term tends to suggest a distribution substation power transformer instead of a transformer at a generation resource substation. A more applicable term would be ‘main step-up (MSU) transformer’. Other possible terms that could be considered are ‘main transformer (MT)’ or ‘station step-up (SSU) transformer’ which is used in the current draft of the Compliance Implementation Guidance PRC-019-2 that is being developed by a NERC Planning Committee task force. The term ‘main transformer’ is used in several places in the recently approved NERC Reliability Guideline – Improvements to Interconnection Requirements for BPS-Connected Inverter-Based Resources (September 2019). Regardless of what the collector transformer is renamed, CenterPoint Energy recommends adding a second figure in Attachment 2 (voltage ride-through) with a station sketch to provide clarity on Footnote 8: “Voltage at the high-side of the GSU or MPT.”

Likes 0

Dislikes 0

Response

Rachel Coyne - Texas Reliability Entity, Inc. - 10

Answer No

Document Name

Comment

Applicable Facilities only address protection up to the GSU or MPT. However, Texas RE has noted voltage protection applied on lines interconnecting a generating Facility to a Transmission station where the line protection is set to trip within the “no-trip zone” of PRC-024-2 Attachment 2. Texas RE recommends the SDT not limit the Facilities that are applicable to the Standard and should include any voltage or frequency protection that would result in an inability of the generating resource to ride through a frequency or voltage excursion as prescribed in Attachment 1 and Attachment 2.

Likes 0

Dislikes 0

Response

Neil Swearingen - Salt River Project - 1,3,5,6 - WECC

Answer No

Document Name

Comment

SRP supports most of the changes to the Applicability section. However SRP requests the SDT clarify 4.2.1, specifically "functions within the associated control systems". The phrase may be interpreted to include exciter settings even though they are covered by PRC-019-2.

Likes 0

Dislikes 0

Response

Kim Thomas - Duke Energy - 1,3,5,6 - SERC,RF, Group Name Duke Energy

Answer No

Document Name

Comment

Given Duke Energy’s response to Question #1, PRC-024 should apply to equipment out to the Point of Interconnection.

Likes 0

Dislikes 0

Response

Thomas Foltz - AEP - 5

Answer

No

Document Name

Comment

The changes proposed to 4.2.1.5, specifically in regards to the text “to the point where those resources aggregate to greater than 75 MVA” may not be reflective of all real-world conditions given that the currently proposed scope has been pared back to the Generator Owner.

Referencing a subset of the BES in the Facilities section seems to be a somewhat unorthodox approach in establishing the Facilities within scope.

Likes 0

Dislikes 0

Response

Daniel Gacek - Exelon - 1

Answer

Yes

Document Name

Comment

Microprocessor technology allows for protection elements to be embedded in a broad variety of control systems. Exelon agrees with the changes made to clarify applicability of the standard to all elements providing protection that is the subject of this standard.

Note that volts per hertz relays are identified within the Applicability Section, however Footnote 4 does not specifically reference volts per hertz relay. For consistency Exelon requests that Volts Per Hertz relays are included in Footnote 4.

On behalf of Exelon, Segments 1, 3, 5, 6

Likes 0

Dislikes 0

Response

Douglas Webb - Douglas Webb On Behalf of: Allen Klassen, Westar Energy, 6, 3, 1, 5; Bryan Taggart, Westar Energy, 6, 3, 1, 5; Derek Brown, Westar Energy, 6, 3, 1, 5; Grant Wilkerson, Westar Energy, 6, 3, 1, 5; James McBee, Great Plains Energy - Kansas City Power and Light Co., 1, 3, 6, 5; Jennifer Flandermeyer, Great Plains Energy - Kansas City Power and Light Co., 1, 3, 6, 5; John Carlson, Great Plains Energy - Kansas

City Power and Light Co., 1, 3, 6, 5; Marcus Moor, Great Plains Energy - Kansas City Power and Light Co., 1, 3, 6, 5; - Douglas Webb, Group Name Westar-KCPL

Answer Yes

Document Name

Comment

Westar Energy and Kansas City Power & Light support the Edison Electric Institutes (EEI) Comments.

Likes 0

Dislikes 0

Response

Mark Gray - Edison Electric Institute - NA - Not Applicable - NA - Not Applicable

Answer Yes

Document Name

Comment

EEI supports the changes made to the Applicability (Facilities) section of PRC-024-3 (Draft 2) believing it accurately reflects those facilities within the US that should be covered under this Reliability Standard. However, one area that the SDT should investigate further is the proposed change from “collector transformer” to “main power transformer (MPT)”. This type of transformers is referenced using at least three different names in three different documents. (i.e., collector transformer – BES Definition; MPT – PRC-024-3 Draft 3 and SSU (Station Step-up) within Implementation Guidance (*Under development by the SPCS*) for PRC-019, pages 71 -73). EEI suggest that NERC and the various SDTs and committees agree on a single name, that is defined, in order to ensure consistency and avoid confusion.

EEI also notes that volts per hertz relays are specifically identified within the Applicability Section (4.2.1), however, in Footnote 4 these relays are not specifically identified. For consistency, EEI suggests making the following change to Footnote 4: (*indicated in bold below*)

Footnote 4: Excludes limitations caused by the setting capability of the frequency, **and** voltage **and volts per hertz** protective relays for the generating resource(s) but does not exclude limitations originating in the equipment that the relays protect or frequency and voltage protection imbedded in control systems.

Likes 0

Dislikes 0

Response

Aaron Cavanaugh - Bonneville Power Administration - 1,3,5,6 - WECC

Answer Yes

Document Name

Comment

None

Likes 0

Dislikes 0

Response

Maryanne Darling-Reich - Black Hills Corporation - 1,3,5,6 - MRO,WECC

Answer

Yes

Document Name

Comment

BHC agrees with EEI's comments as submitted

Likes 0

Dislikes 0

Response

Wayne Guttormson - SaskPower - 1

Answer

Yes

Document Name

Comment

Likes 0

Dislikes 0

Response

Teresa Cantwell - Lower Colorado River Authority - 5

Answer

Yes

Document Name

Comment

Likes 0

Dislikes 0

Response

Trevor Tidwell - PNM Resources - Public Service Company of New Mexico - 3

Answer Yes

Document Name

Comment

Likes 0

Dislikes 0

Response

Chantal Mazza - Hydro-Qu?bec TransEnergie - 2 - NPCC

Answer Yes

Document Name

Comment

Likes 0

Dislikes 0

Response

Line Dufour - Hydro-Qu?bec Production - 6 - NPCC

Answer Yes

Document Name

Comment

Likes 0

Dislikes 0

Response

Larry Heckert - Alliant Energy Corporation Services, Inc. - 4

Answer Yes

Document Name

Comment

Likes 0

Dislikes 0

Response**Jodirah Green - ACES Power Marketing - 1,3,4,5,6 - MRO,WECC,Texas RE,SERC,RF, Group Name ACES Standard Collaborations****Answer**

Yes

Document Name**Comment**

Likes 0

Dislikes 0

Response**Karie Barczak - DTE Energy - Detroit Edison Company - 3, Group Name DTE Energy - DTE Electric****Answer**

Yes

Document Name**Comment**

Likes 0

Dislikes 0

Response**Ruida Shu - Northeast Power Coordinating Council - 1,2,3,4,5,6,7,8,9,10 - NPCC, Group Name RSC****Answer**

Yes

Document Name**Comment**

Likes 0

Dislikes 0

Response

Glenn Barry - Los Angeles Department of Water and Power - 5

Answer Yes

Document Name

Comment

Likes 0

Dislikes 0

Response

Bruce Reimer - Manitoba Hydro - 1

Answer Yes

Document Name

Comment

Likes 0

Dislikes 0

Response

Sean Bodkin - Dominion - Dominion Resources, Inc. - 6, Group Name Dominion

Answer Yes

Document Name

Comment

Likes 0

Dislikes 0

Response

Nick Batty - Keys Energy Services - 9 - SERC

Answer Yes

Document Name

Comment

Likes 0

Dislikes 0

Response

Jamie Monette - Allele - Minnesota Power, Inc. - 1

Answer

Yes

Document Name

Comment

Likes 0

Dislikes 0

Response

Michael Goggin - Grid Strategies - 5 - NA - Not Applicable

Answer

Yes

Document Name

Comment

Likes 0

Dislikes 0

Response

Siddharth Pant - GE - General Electric Power Systems - NA - Not Applicable - NA - Not Applicable

Answer

Yes

Document Name

Comment

Likes 0

Dislikes 0

Response

Richard Jackson - U.S. Bureau of Reclamation - 1

Answer	Yes
---------------	-----

Document Name	
----------------------	--

Comment

Likes 0

Dislikes 0

Response

Glen Farmer - Avista - Avista Corporation - 5

Answer	Yes
---------------	-----

Document Name	
----------------------	--

Comment

Likes 0

Dislikes 0

Response

Davis Jelusich - Public Utility District No. 1 of Chelan County - 6, Group Name Public Utility District No. 1 of Chelan County

Answer	Yes
---------------	-----

Document Name	
----------------------	--

Comment

Likes 0

Dislikes 0

Response

Donald Lynd - CMS Energy - Consumers Energy Company - 1

Answer	Yes
---------------	-----

Document Name	
----------------------	--

Comment

Likes 0

Dislikes 0

Response

Amy Casuscelli - Amy Casuscelli On Behalf of: Carrie Dixon, Xcel Energy, Inc. , 6; Gerry Huitt, Xcel Energy, Inc., 1, 5, 3; - Amy Casuscelli

Answer

Yes

Document Name

Comment

Likes 0

Dislikes 0

Response

Karl Blaszkowski - CMS Energy - Consumers Energy Company - 3

Answer

Yes

Document Name

Comment

Likes 0

Dislikes 0

Response

Mark Garza - FirstEnergy - FirstEnergy Corporation - 4, Group Name FE Voter

Answer

Yes

Document Name

Comment

Likes 0

Dislikes 0

Response

Dana Klem - MRO - 1,2,3,4,5,6 - MRO, Group Name MRO NSRF

Answer	Yes
Document Name	
Comment	
Likes 0	
Dislikes 0	
Response	
Dennis Chastain - Tennessee Valley Authority - 1,3,5,6 - SERC	
Answer	Yes
Document Name	
Comment	
Likes 0	
Dislikes 0	
Response	
Bridget Silvia - Sempra - San Diego Gas and Electric - 3	
Answer	Yes
Document Name	
Comment	
Likes 0	
Dislikes 0	
Response	
Kevin Conway - Public Utility District No. 1 of Pend Oreille County - 1,3,5,6	
Answer	Yes
Document Name	
Comment	
Likes 0	

Dislikes 0

Response

Anthony Jablonski - ReliabilityFirst - 10

Answer

Yes

Document Name

Comment

Likes 0

Dislikes 0

Response

Leonard Kula - Independent Electricity System Operator - 2

Answer

Yes

Document Name

Comment

Likes 0

Dislikes 0

Response

Jeanne Kurzynowski - CMS Energy - Consumers Energy Company - 1,3,4,5 - RF

Answer

Yes

Document Name

Comment

Likes 0

Dislikes 0

Response

Bette White - AES - Indianapolis Power and Light Co. - 3

Answer

Yes

Document Name	
Comment	
Likes 0	
Dislikes 0	
Response	
Michelle Amarantos - APS - Arizona Public Service Co. - 1	
Answer	Yes
Document Name	
Comment	
Likes 0	
Dislikes 0	
Response	
Chris Wagner - Santee Cooper - 1, Group Name Santee Cooper	
Answer	Yes
Document Name	
Comment	
Likes 0	
Dislikes 0	
Response	
Matthew Nutsch - Seattle City Light - 1,3,4,5,6 - WECC	
Answer	Yes
Document Name	
Comment	
Likes 0	
Dislikes 0	

Response

3. To address Scope Item 'f' from the approved SAR, the SDT added an exemption to the Applicability (Facilities) to clarify that all auxiliary equipment and associated protection(s) within the generating Facility are not applicable to the standard. Do you agree with the 'Exemption'? If not, please provide the basis for your disagreement and an alternate solution.

Rachel Coyne - Texas Reliability Entity, Inc. - 10

Answer No

Document Name

Comment

The language in section 4.2.1.3 appears to conflict with the language in section 4.2.2. Section 4.2.3.1 includes the high side of the generator-connected auxiliary transformer, while section 4.2.2 exempts protection on all auxiliary equipment within the generating Facility. Please clarify why Facilities meeting applicability Section 4.2.1.3 would not fall under this exemption.

Texas RE has the following additional comments:

- The Severe VSL for R4 needs an additional row space between settings and "OR".
- Page 9 of 23 states: "In Requirements R1, R3, and R4, all references to "Generator Owner" are replaced with "Generator Owner *and* Transmission Owner." Texas RE noticed on Page 12 of 23: VSL for D.A.2. says Generator owner "**or**" Transmission Owner. Should it be changed to "**and**" to be consistent with the statement above?

Likes 0

Dislikes 0

Response

Marty Hostler - Northern California Power Agency - 5

Answer No

Document Name

Comment

See TRE comments.

Likes 0

Dislikes 0

Response

Dana Klem - MRO - 1,2,3,4,5,6 - MRO, Group Name MRO NSRF

Answer Yes

Document Name

Comment

Volts/Hertz relaying is specifically included in the applicability section 4.2.1., but is not included in the exemptions listed in Footnote 4. Please include the relay function Volts/Hertz as part of Footnote 4.

Likes 0

Dislikes 0

Response

Maryanne Darling-Reich - Black Hills Corporation - 1,3,5,6 - MRO,WECC

Answer

Yes

Document Name

Comment

BHC agrees with EEI's comments as submitted

Likes 0

Dislikes 0

Response

Aaron Cavanaugh - Bonneville Power Administration - 1,3,5,6 - WECC

Answer

Yes

Document Name

Comment

None

Likes 0

Dislikes 0

Response

Larry Heckert - Alliant Energy Corporation Services, Inc. - 4

Answer

Yes

Document Name

Comment

Support NSRF Comments:

Volts/Hertz relaying is specifically included in the applicability section 4.2.1., but is not included in the exemptions listed in Footnote 4. Please include the relay function Volts/Hertz as part of Footnote 4.

Likes 0

Dislikes 0

Response

Daniel Gacek - Exelon - 1

Answer

Yes

Document Name

Comment

Exelon appreciates and supports the clearly stated exemption for auxiliary equipment.

On behalf of Exelon, Segments 1, 3, 5, 6

Likes 0

Dislikes 0

Response

Wayne Guttormson - SaskPower - 1

Answer

Yes

Document Name

Comment

Support the MRO NSRF comments.

Likes 0

Dislikes 0

Response

Matthew Nutsch - Seattle City Light - 1,3,4,5,6 - WECC

Answer

Yes

Document Name	
Comment	
Likes 0	
Dislikes 0	
Response	
Chris Wagner - Santee Cooper - 1, Group Name Santee Cooper	
Answer	Yes
Document Name	
Comment	
Likes 0	
Dislikes 0	
Response	
Michelle Amarantos - APS - Arizona Public Service Co. - 1	
Answer	Yes
Document Name	
Comment	
Likes 0	
Dislikes 0	
Response	
Bette White - AES - Indianapolis Power and Light Co. - 3	
Answer	Yes
Document Name	
Comment	
Likes 0	
Dislikes 0	

Response

Jeanne Kurzynowski - CMS Energy - Consumers Energy Company - 1,3,4,5 - RF

Answer Yes

Document Name

Comment

Likes 0

Dislikes 0

Response

Leonard Kula - Independent Electricity System Operator - 2

Answer Yes

Document Name

Comment

Likes 0

Dislikes 0

Response

Anthony Jablonski - ReliabilityFirst - 10

Answer Yes

Document Name

Comment

Likes 0

Dislikes 0

Response

Thomas Foltz - AEP - 5

Answer Yes

Document Name

Comment

Likes 0

Dislikes 0

Response**Kevin Conway - Public Utility District No. 1 of Pend Oreille County - 1,3,5,6****Answer**

Yes

Document Name**Comment**

Likes 0

Dislikes 0

Response**Bridget Silvia - Sempra - San Diego Gas and Electric - 3****Answer**

Yes

Document Name**Comment**

Likes 0

Dislikes 0

Response**Dennis Chastain - Tennessee Valley Authority - 1,3,5,6 - SERC****Answer**

Yes

Document Name**Comment**

Likes 0

Dislikes 0

Response

Mark Garza - FirstEnergy - FirstEnergy Corporation - 4, Group Name FE Voter

Answer Yes

Document Name

Comment

Likes 0

Dislikes 0

Response

Karl Blaszkowski - CMS Energy - Consumers Energy Company - 3

Answer Yes

Document Name

Comment

Likes 0

Dislikes 0

Response

Kim Thomas - Duke Energy - 1,3,5,6 - SERC,RF, Group Name Duke Energy

Answer Yes

Document Name

Comment

Likes 0

Dislikes 0

Response

Amy Casuscelli - Amy Casuscelli On Behalf of: Carrie Dixon, Xcel Energy, Inc. , 6; Gerry Huitt, Xcel Energy, Inc., 1, 5, 3; - Amy Casuscelli

Answer Yes

Document Name

Comment

Likes 0

Dislikes 0

Response

Donald Lynd - CMS Energy - Consumers Energy Company - 1

Answer

Yes

Document Name

Comment

Likes 0

Dislikes 0

Response

Davis Jelusich - Public Utility District No. 1 of Chelan County - 6, Group Name Public Utility District No. 1 of Chelan County

Answer

Yes

Document Name

Comment

Likes 0

Dislikes 0

Response

Glen Farmer - Avista - Avista Corporation - 5

Answer

Yes

Document Name

Comment

Likes 0

Dislikes 0

Response

Neil Swearingen - Salt River Project - 1,3,5,6 - WECC

Answer	Yes
---------------	-----

Document Name	
----------------------	--

Comment	
----------------	--

Likes	0
-------	---

Dislikes	0
----------	---

Response	
-----------------	--

Richard Jackson - U.S. Bureau of Reclamation - 1

Answer	Yes
---------------	-----

Document Name	
----------------------	--

Comment	
----------------	--

Likes	0
-------	---

Dislikes	0
----------	---

Response	
-----------------	--

Siddharth Pant - GE - General Electric Power Systems - NA - Not Applicable - NA - Not Applicable

Answer	Yes
---------------	-----

Document Name	
----------------------	--

Comment	
----------------	--

Likes	0
-------	---

Dislikes	0
----------	---

Response	
-----------------	--

Jamie Monette - Allete - Minnesota Power, Inc. - 1

Answer	Yes
---------------	-----

Document Name	
----------------------	--

Comment	
----------------	--

Likes 0

Dislikes 0

Response

Nick Batty - Keys Energy Services - 9 - SERC

Answer

Yes

Document Name

Comment

Likes 0

Dislikes 0

Response

Sean Bodkin - Dominion - Dominion Resources, Inc. - 6, Group Name Dominion

Answer

Yes

Document Name

Comment

Likes 0

Dislikes 0

Response

Bruce Reimer - Manitoba Hydro - 1

Answer

Yes

Document Name

Comment

Likes 0

Dislikes 0

Response

Glenn Barry - Los Angeles Department of Water and Power - 5

Answer	Yes
Document Name	
Comment	
Likes 0	
Dislikes 0	
Response	
Ruida Shu - Northeast Power Coordinating Council - 1,2,3,4,5,6,7,8,9,10 - NPCC, Group Name RSC	
Answer	Yes
Document Name	
Comment	
Likes 0	
Dislikes 0	
Response	
Karie Barczak - DTE Energy - Detroit Edison Company - 3, Group Name DTE Energy - DTE Electric	
Answer	Yes
Document Name	
Comment	
Likes 0	
Dislikes 0	
Response	
Mark Gray - Edison Electric Institute - NA - Not Applicable - NA - Not Applicable	
Answer	Yes
Document Name	
Comment	
Likes 0	

Dislikes 0

Response

Jodirah Green - ACES Power Marketing - 1,3,4,5,6 - MRO,WECC,Texas RE,SERC,RF, Group Name ACES Standard Collaborations

Answer Yes

Document Name

Comment

Likes 0

Dislikes 0

Response

Douglas Webb - Douglas Webb On Behalf of: Allen Klassen, Westar Energy, 6, 3, 1, 5; Bryan Taggart, Westar Energy, 6, 3, 1, 5; Derek Brown, Westar Energy, 6, 3, 1, 5; Grant Wilkerson, Westar Energy, 6, 3, 1, 5; James McBee, Great Plains Energy - Kansas City Power and Light Co., 1, 3, 6, 5; Jennifer Flandermeyer, Great Plains Energy - Kansas City Power and Light Co., 1, 3, 6, 5; John Carlson, Great Plains Energy - Kansas City Power and Light Co., 1, 3, 6, 5; Marcus Moor, Great Plains Energy - Kansas City Power and Light Co., 1, 3, 6, 5; - Douglas Webb, Group Name Westar-KCPL

Answer Yes

Document Name

Comment

Likes 0

Dislikes 0

Response

Line Dufour - Hydro-Quebec Production - 6 - NPCC

Answer Yes

Document Name

Comment

Likes 0

Dislikes 0

Response

Chantal Mazza - Hydro-Qu?bec TransEnergie - 2 - NPCC**Answer** Yes**Document Name****Comment**

Likes 0

Dislikes 0

Response**Constantin Chitescu - Ontario Power Generation Inc. - 5****Answer** Yes**Document Name****Comment**

Likes 0

Dislikes 0

Response**Chris Gowder - Florida Municipal Power Agency - 5, Group Name FMPA****Answer** Yes**Document Name****Comment**

Likes 0

Dislikes 0

Response**Trevor Tidwell - PNM Resources - Public Service Company of New Mexico - 3****Answer** Yes**Document Name****Comment**

Likes 0

Dislikes 0

Response

Pamela Hunter - Southern Company - Southern Company Services, Inc. - 1,3,5,6 - SERC, Group Name Southern Company

Answer

Yes

Document Name

Comment

Likes 0

Dislikes 0

Response

Teresa Cantwell - Lower Colorado River Authority - 5

Answer

Yes

Document Name

Comment

Likes 0

Dislikes 0

Response

4. Based on industry feedback, the SDT replaced the 0.1 second 'Minimum Time (Sec)' value in the frequency tables with "Instantaneous" and provided additional clarity via Footnote #6 regarding frequency calculation/measurement. Do you agree with this change? If not, please provide the basis for your disagreement and an alternate solution.

Marty Hostler - Northern California Power Agency - 5

Answer No

Document Name

Comment

It appears it was changed back to what is was originally? We need a Redline showing changes form the last approved standard to the current proposal.

Likes 0

Dislikes 0

Response

Jamie Monette - Allete - Minnesota Power, Inc. - 1

Answer No

Document Name

Comment

Minnesota Power suggests changing the frequency tables and figures to show "Time Delay" rather than "Time." Then the tables could show 0.0 seconds, or they could go back to what was shown in PRC-024-2 "Instantaneous Trip."

Minnesota Power suggests altering Footnote 7 to read:

"Frequency is calculated over a window of time. Time delays shown in Attachment 1 Figures 1-4 and Tables 1-4 refer to the minimum required time delay after the frequency calculation has completed."

The last sentence of the current footnote is confusing ("Instantaneous trip settings based on instantaneously calculated frequency measurement is note permissible."). If this sentence remains, the standard should clarify the minimum window required rather than just describing a typical window.

Likes 0

Dislikes 0

Response

Wayne Guttormson - SaskPower - 1

Answer Yes

Document Name

Comment

Support the MRO NSRF comments.

Likes 0

Dislikes 0

Response

Daniel Gacek - Exelon - 1

Answer

Yes

Document Name

Comment

Exelon agrees with the change back to “Instantaneous”, however Footnote #7 describes a concern associated with microprocessor protection only and should therefore be limited to microprocessor protection.

Exelon suggests the following language:

7 Microprocessor protection calculates frequency over a window of time. While the frequency boundaries include the option to trip instantaneously for frequencies outside the specified range, microprocessor protection should perform this calculation over a time window. Typical window/filtering lengths are three to six cycles (50 – 100 milliseconds). Instantaneous trip settings by microprocessor protection based on instantaneously calculated frequency measurement is not permissible. Electromechanical and solid-state protection does not exhibit the concern described and may use instantaneous trip settings.

On behalf of Exelon, Segments 1, 3, 5, 6

Likes 0

Dislikes 0

Response

Larry Heckert - Alliant Energy Corporation Services, Inc. - 4

Answer

Yes

Document Name

Comment

Support NSRF comments:

Footnote 7 states that instantaneous trip settings based on instantaneously calculated frequency measurement is not permissible. We request an explanation of the technical basis of this footnote and methods to determine whether our trip settings are permissible. It seems that verification will be difficult to achieve without input from relay manufacturers.

Likes	0
Dislikes	0
Response	
Ruida Shu - Northeast Power Coordinating Council - 1,2,3,4,5,6,7,8,9,10 - NPCC, Group Name RSC	
Answer	Yes
Document Name	
Comment	
<p>Please include the NPCC Region's underfrequency no-trip boundary in the Supplemental Material section of the standard – Attachment 1. The NPCC Region's under-frequency boundary is more stringent than the Eastern Interconnection Boundary.</p> <p>The low voltage duration, voltage (pu) < 0.45 minimum (sec) 0.15 appears to be insufficient. Clearing times for High Voltage circuits can often exceed 0.15 seconds. Therefore, the exposure to generators tripping during normally cleared faults is higher than optimal. Please consider increasing the Low Voltage Duration No Trip Zone-boundary for the <0.45 pu voltage threshold.</p> <p>Please consider adding additional details of restrictions on active and reactive power cessations during underfrequency or overfrequency conditions. As written, the standard could allow momentary cessation of active (real) current inside the frequency envelope of Attachment 1, as long as reactive current is provided. Cessation of active (real) current for frequencies inside the frequency envelope could compromise the effectiveness of the UFLS program.</p>	
Likes	0
Dislikes	0
Response	
Bruce Reimer - Manitoba Hydro - 1	
Answer	Yes
Document Name	
Comment	
Shouldn't the graph also reflect this change with the minimum time changed to 0 second?	
Likes	0
Dislikes	0
Response	
Rachel Coyne - Texas Reliability Entity, Inc. - 10	
Answer	Yes

Document Name	
Comment	
Texas RE noticed this shows as Footnote 7, not Footnote 6.	
Likes 0	
Dislikes 0	
Response	
Aaron Cavanaugh - Bonneville Power Administration - 1,3,5,6 - WECC	
Answer	Yes
Document Name	
Comment	
None	
Likes 0	
Dislikes 0	
Response	
Maryanne Darling-Reich - Black Hills Corporation - 1,3,5,6 - MRO,WECC	
Answer	Yes
Document Name	
Comment	
BHC agrees with EEI's comments as submitted	
Likes 0	
Dislikes 0	
Response	
Dana Klem - MRO - 1,2,3,4,5,6 - MRO, Group Name MRO NSRF	
Answer	Yes
Document Name	
Comment	

Footnote 7 states that instantaneous trip settings based on instantaneously calculated frequency measurement is not permissible. We request an explanation of the technical basis of this footnote and methods to determine whether our trip settings are permissible. It seems that verification will be difficult to achieve without input from relay manufacturers.

The note, "The area outside the "No Trip Zone" is not a "Must Trip Zone" is not included after the graph on PRC-024 – Attachment 2, Page 21/27 of the redline draft 09202019.

Likes 0

Dislikes 0

Response

Leonard Kula - Independent Electricity System Operator - 2

Answer

Yes

Document Name

Comment

In order to prevent the facility from being tripped for phase to ground faults cleared in breaker failure time, we suggest that the wording "Unless otherwise specified by the Transmission Planner" be added to the Boundary Details #4 in Attachment 2: Voltage Boundary Clarifications – Eastern, Western, and ERCOT Interconnections, as follows:

" 4. Unless otherwise specified by the Transmission Planner, voltages in boundaries assume RMS fundamental frequency phase-to-phase ground or phase-to-phase unit per unit voltage."

Likes 0

Dislikes 0

Response

Teresa Cantwell - Lower Colorado River Authority - 5

Answer

Yes

Document Name

Comment

Likes 0

Dislikes 0

Response

Trevor Tidwell - PNM Resources - Public Service Company of New Mexico - 3

Answer	Yes
Document Name	
Comment	
Likes 0	
Dislikes 0	
Response	
Chris Gowder - Florida Municipal Power Agency - 5, Group Name FMPA	
Answer	Yes
Document Name	
Comment	
Likes 0	
Dislikes 0	
Response	
Constantin Chitescu - Ontario Power Generation Inc. - 5	
Answer	Yes
Document Name	
Comment	
Likes 0	
Dislikes 0	
Response	
Chantal Mazza - Hydro-Qu?bec TransEnergie - 2 - NPCC	
Answer	Yes
Document Name	
Comment	
Likes 0	

Dislikes 0

Response

Line Dufour - Hydro-Quebec Production - 6 - NPCC

Answer Yes

Document Name

Comment

Likes 0

Dislikes 0

Response

Douglas Webb - Douglas Webb On Behalf of: Allen Klassen, Westar Energy, 6, 3, 1, 5; Bryan Taggart, Westar Energy, 6, 3, 1, 5; Derek Brown, Westar Energy, 6, 3, 1, 5; Grant Wilkerson, Westar Energy, 6, 3, 1, 5; James McBee, Great Plains Energy - Kansas City Power and Light Co., 1, 3, 6, 5; Jennifer Flandermeyer, Great Plains Energy - Kansas City Power and Light Co., 1, 3, 6, 5; John Carlson, Great Plains Energy - Kansas City Power and Light Co., 1, 3, 6, 5; Marcus Moor, Great Plains Energy - Kansas City Power and Light Co., 1, 3, 6, 5; - Douglas Webb, Group Name Westar-KCPL

Answer Yes

Document Name

Comment

Likes 0

Dislikes 0

Response

Jodirah Green - ACES Power Marketing - 1,3,4,5,6 - MRO,WECC,Texas RE,SERC,RF, Group Name ACES Standard Collaborations

Answer Yes

Document Name

Comment

Likes 0

Dislikes 0

Response

Mark Gray - Edison Electric Institute - NA - Not Applicable - NA - Not Applicable

Answer Yes

Document Name

Comment

Likes 0

Dislikes 0

Response

Karie Barczak - DTE Energy - Detroit Edison Company - 3, Group Name DTE Energy - DTE Electric

Answer Yes

Document Name

Comment

Likes 0

Dislikes 0

Response

Glenn Barry - Los Angeles Department of Water and Power - 5

Answer Yes

Document Name

Comment

Likes 0

Dislikes 0

Response

Sean Bodkin - Dominion - Dominion Resources, Inc. - 6, Group Name Dominion

Answer Yes

Document Name

Comment

Likes 0

Dislikes 0

Response

Nick Batty - Keys Energy Services - 9 - SERC

Answer Yes

Document Name

Comment

Likes 0

Dislikes 0

Response

Michael Goggin - Grid Strategies - 5 - NA - Not Applicable

Answer Yes

Document Name

Comment

Likes 0

Dislikes 0

Response

Siddharth Pant - GE - General Electric Power Systems - NA - Not Applicable - NA - Not Applicable

Answer Yes

Document Name

Comment

Likes 0

Dislikes 0

Response

Richard Jackson - U.S. Bureau of Reclamation - 1

Answer	Yes
Document Name	
Comment	
Likes 0	
Dislikes 0	
Response	
Neil Swearingen - Salt River Project - 1,3,5,6 - WECC	
Answer	Yes
Document Name	
Comment	
Likes 0	
Dislikes 0	
Response	
Glen Farmer - Avista - Avista Corporation - 5	
Answer	Yes
Document Name	
Comment	
Likes 0	
Dislikes 0	
Response	
Davis Jelusich - Public Utility District No. 1 of Chelan County - 6, Group Name Public Utility District No. 1 of Chelan County	
Answer	Yes
Document Name	
Comment	
Likes 0	

Dislikes 0

Response

Donald Lynd - CMS Energy - Consumers Energy Company - 1

Answer

Yes

Document Name

Comment

Likes 0

Dislikes 0

Response

Amy Casuscelli - Amy Casuscelli On Behalf of: Carrie Dixon, Xcel Energy, Inc. , 6; Gerry Huitt, Xcel Energy, Inc., 1, 5, 3; - Amy Casuscelli

Answer

Yes

Document Name

Comment

Likes 0

Dislikes 0

Response

Kim Thomas - Duke Energy - 1,3,5,6 - SERC,RF, Group Name Duke Energy

Answer

Yes

Document Name

Comment

Likes 0

Dislikes 0

Response

Karl Blaszkowski - CMS Energy - Consumers Energy Company - 3

Answer

Yes

Document Name	
Comment	
Likes 0	
Dislikes 0	
Response	
Mark Garza - FirstEnergy - FirstEnergy Corporation - 4, Group Name FE Voter	
Answer	Yes
Document Name	
Comment	
Likes 0	
Dislikes 0	
Response	
Dennis Chastain - Tennessee Valley Authority - 1,3,5,6 - SERC	
Answer	Yes
Document Name	
Comment	
Likes 0	
Dislikes 0	
Response	
Bridget Silvia - Sempra - San Diego Gas and Electric - 3	
Answer	Yes
Document Name	
Comment	
Likes 0	
Dislikes 0	

Response

Kevin Conway - Public Utility District No. 1 of Pend Oreille County - 1,3,5,6

Answer Yes

Document Name

Comment

Likes 0

Dislikes 0

Response

Thomas Foltz - AEP - 5

Answer Yes

Document Name

Comment

Likes 0

Dislikes 0

Response

Anthony Jablonski - ReliabilityFirst - 10

Answer Yes

Document Name

Comment

Likes 0

Dislikes 0

Response

Jeanne Kurzynowski - CMS Energy - Consumers Energy Company - 1,3,4,5 - RF

Answer Yes

Document Name

Comment

Likes 0

Dislikes 0

Response**Bette White - AES - Indianapolis Power and Light Co. - 3****Answer**

Yes

Document Name**Comment**

Likes 0

Dislikes 0

Response**Michelle Amarantos - APS - Arizona Public Service Co. - 1****Answer**

Yes

Document Name**Comment**

Likes 0

Dislikes 0

Response**Chris Wagner - Santee Cooper - 1, Group Name Santee Cooper****Answer**

Yes

Document Name**Comment**

Likes 0

Dislikes 0

Response

Matthew Nutsch - Seattle City Light - 1,3,4,5,6 - WECC

Answer

Yes

Document Name

Comment

Likes 0

Dislikes 0

Response

5. Based on industry feedback, the SDT revised the Implementation Plan to provide twenty-four months for applicable entities to evaluate settings, make changes for applicable equipment, and purchase necessary equipment, if necessary. Do you agree with the revised Implementation Plan? If not, please provide the basis for your disagreement and an alternate proposal.

Thomas Foltz - AEP - 5

Answer No

Document Name

Comment

As we similarly stated in the previous comment period, we believe that 24 months is still insufficient, especially in regards to impacts associated with a) changing, albeit unintentionally, the historically recognized "Point of Interconnection" as the reference point of compliance and b) the inclusion of applicable functions on the high side of generator-connected auxiliary transformers. AEP suggests that the proposed implementation plan be increased to 36 months as the proposed changes would redefine the entire scope of the work performed to date.

There are a number of important, non-controversial clarifications being proposed to improve this standard that should not be delayed by the perhaps more controversial and possibly even more time-consuming requirements. For example, the proposed clarifications for Attachments 1 and 2 could and should be implemented as soon as practical, however any revisions affecting the applicability scope or "point of interconnection" should be delayed in their implementation. As a result, we suggest splitting implementation to advance as rapidly as possible these clarifications.

Likes 0

Dislikes 0

Response

Dennis Chastain - Tennessee Valley Authority - 1,3,5,6 - SERC

Answer No

Document Name

Comment

As discussed in some detail in the previous round of comments, the 24-month implementation period (though better than the original 18-month one) is still not enough time for some (nuclear, in particular) units to implement the new requirements if they have equipment that has to be modified. Per the typical nuclear projects process, they have to 1) obtain funding for and perform an analysis to see if they have compliance gaps [this can take a year plus, depending on when this version gets approved and where they are in the annual funding cycle] and, if so, 2) obtain funding for the change(s) [possibly another year plus], 3) instigate and award a contract to a design partner to complete the design for the change(s) [9 months to a year], and 4) implement the changes which will likely require an outage that can be as much as two years in the future [the change(s) likely won't be that hard to do, but the projects process requires that designs be complete at least 13 months prior to the beginning of the outage, which adds another year plus]. All together, these timeframes could easily add up to well over four years. The original dates for version 1 (and 2) were phased in over a 5-year period. This same issue was raised for the implementation of PRC-025-2 and its SDT provided 5-years to implement the requirements for any new scope. Please provide a 5-year implementation period to give time to implement any required modifications within the standard projects process.

Likes 0

Dislikes 0

Response

Mark Garza - FirstEnergy - FirstEnergy Corporation - 4, Group Name FE Voter

Answer No

Document Name

Comment

Consider a 60-month phased implementation plan as setting changes require time to account for planning, budgeting and outage coordination.

Likes 0

Dislikes 0

Response

Karie Barczak - DTE Energy - Detroit Edison Company - 3, Group Name DTE Energy - DTE Electric

Answer No

Document Name

Comment

24 months is not sufficient for nuclear power plants. Please reconsider a 36 or 48 month implementation plan.

Likes 0

Dislikes 0

Response

Marty Hostler - Northern California Power Agency - 5

Answer No

Document Name

Comment

NERC originally provided a five year progressive implementation plan for PRC-024-1 and -2. PRC-023-3's original SAR was for Inverter based resources, then a supplemental SAR was developed include UAT and GSUs protection. All PRC-024 studies now have to be redone and potentially more modifications/additions made. The implementation plan should be 5-years.

Likes 0

Dislikes 0

Response

Daniel Gacek - Exelon - 1

Answer No

Document Name

Comment

As discussed in some detail in the previous round of comments, the 24-month implementation period (though better than the original 18-month one) is still not enough time for existing, non-inverter based generating units to perform studies, assess compliance with the new revision to the Standard, and implement any necessary modification

Nuclear units typically operate continuously and therefore modifications are scheduled during refueling outages. Refueling outages take place approximately every two years and the work is scheduled years in advance. From budgeting to execution, the modification process at a nuclear unit can add up to well over four years.

This concern was also communicated to the NERC SDT for PRC-025-2 resulting a 5-year implementation period for scope changes.

The original dates for PRC-024 version 1 (and 2) were phased in over a 5-year period. Please consider the same 5-year implementation period for existing, non-inverter based generating units to perform studies and implement any required modifications within their established projects timeframe.

On behalf of Exelon, Segments 1, 3, 5, 6

Likes 0

Dislikes 0

Response

Anthony Jablonski - ReliabilityFirst - 10

Answer Yes

Document Name

Comment

ReliabilityFirst notes that there is currently an ERO-endorsed guidance on PRC-024-2. Can ReliabilityFirst assume this ERO-endorsed guidance will be updated as well whenever PRC-024-3 is approved?

Likes 0

Dislikes 0

Response

Maryanne Darling-Reich - Black Hills Corporation - 1,3,5,6 - MRO,WECC

Answer Yes

Document Name

Comment

BHC agrees with EEI's comments as submitted

Likes 0

Dislikes 0

Response

Aaron Cavanaugh - Bonneville Power Administration - 1,3,5,6 - WECC

Answer Yes

Document Name

Comment

None

Likes 0

Dislikes 0

Response

Matthew Nutsch - Seattle City Light - 1,3,4,5,6 - WECC

Answer Yes

Document Name

Comment

Likes 0

Dislikes 0

Response

Chris Wagner - Santee Cooper - 1, Group Name Santee Cooper

Answer Yes

Document Name

Comment

Likes 0

Dislikes 0

Response

Michelle Amarantos - APS - Arizona Public Service Co. - 1

Answer

Yes

Document Name

Comment

Likes 0

Dislikes 0

Response

Bette White - AES - Indianapolis Power and Light Co. - 3

Answer

Yes

Document Name

Comment

Likes 0

Dislikes 0

Response

Jeanne Kurzynowski - CMS Energy - Consumers Energy Company - 1,3,4,5 - RF

Answer

Yes

Document Name

Comment

Likes 0

Dislikes 0

Response

Kevin Conway - Public Utility District No. 1 of Pend Oreille County - 1,3,5,6

Answer Yes

Document Name

Comment

Likes 0

Dislikes 0

Response

Bridget Silvia - Sempra - San Diego Gas and Electric - 3

Answer Yes

Document Name

Comment

Likes 0

Dislikes 0

Response

Dana Klem - MRO - 1,2,3,4,5,6 - MRO, Group Name MRO NSRF

Answer Yes

Document Name

Comment

Likes 0

Dislikes 0

Response

Karl Blaszkowski - CMS Energy - Consumers Energy Company - 3

Answer Yes

Document Name

Comment

Likes 0

Dislikes 0

Response

Kim Thomas - Duke Energy - 1,3,5,6 - SERC,RF, Group Name Duke Energy

Answer

Yes

Document Name

Comment

Likes 0

Dislikes 0

Response

Amy Casuscelli - Amy Casuscelli On Behalf of: Carrie Dixon, Xcel Energy, Inc. , 6; Gerry Huitt, Xcel Energy, Inc., 1, 5, 3; - Amy Casuscelli

Answer

Yes

Document Name

Comment

Likes 0

Dislikes 0

Response

Donald Lynd - CMS Energy - Consumers Energy Company - 1

Answer

Yes

Document Name

Comment

Likes 0

Dislikes 0

Response

Davis Jelusich - Public Utility District No. 1 of Chelan County - 6, Group Name Public Utility District No. 1 of Chelan County

Answer Yes

Document Name

Comment

Likes 0

Dislikes 0

Response

Glen Farmer - Avista - Avista Corporation - 5

Answer Yes

Document Name

Comment

Likes 0

Dislikes 0

Response

Neil Swearingen - Salt River Project - 1,3,5,6 - WECC

Answer Yes

Document Name

Comment

Likes 0

Dislikes 0

Response

Richard Jackson - U.S. Bureau of Reclamation - 1

Answer Yes

Document Name

Comment

Likes 0

Dislikes 0

Response

Siddharth Pant - GE - General Electric Power Systems - NA - Not Applicable - NA - Not Applicable

Answer

Yes

Document Name

Comment

Likes 0

Dislikes 0

Response

Jamie Monette - Allete - Minnesota Power, Inc. - 1

Answer

Yes

Document Name

Comment

Likes 0

Dislikes 0

Response

Rachel Coyne - Texas Reliability Entity, Inc. - 10

Answer

Yes

Document Name

Comment

Likes 0

Dislikes 0

Response

Nick Batty - Keys Energy Services - 9 - SERC

Answer	Yes
Document Name	
Comment	
Likes 0	
Dislikes 0	
Response	
Sean Bodkin - Dominion - Dominion Resources, Inc. - 6, Group Name Dominion	
Answer	Yes
Document Name	
Comment	
Likes 0	
Dislikes 0	
Response	
Bruce Reimer - Manitoba Hydro - 1	
Answer	Yes
Document Name	
Comment	
Likes 0	
Dislikes 0	
Response	
Glenn Barry - Los Angeles Department of Water and Power - 5	
Answer	Yes
Document Name	
Comment	
Likes 0	

Dislikes 0

Response

Ruida Shu - Northeast Power Coordinating Council - 1,2,3,4,5,6,7,8,9,10 - NPCC, Group Name RSC

Answer Yes

Document Name

Comment

Likes 0

Dislikes 0

Response

Mark Gray - Edison Electric Institute - NA - Not Applicable - NA - Not Applicable

Answer Yes

Document Name

Comment

Likes 0

Dislikes 0

Response

Jodirah Green - ACES Power Marketing - 1,3,4,5,6 - MRO,WECC,Texas RE,SERC,RF, Group Name ACES Standard Collaborations

Answer Yes

Document Name

Comment

Likes 0

Dislikes 0

Response

Douglas Webb - Douglas Webb On Behalf of: Allen Klassen, Westar Energy, 6, 3, 1, 5; Bryan Taggart, Westar Energy, 6, 3, 1, 5; Derek Brown, Westar Energy, 6, 3, 1, 5; Grant Wilkerson, Westar Energy, 6, 3, 1, 5; James McBee, Great Plains Energy - Kansas City Power and Light Co., 1, 3, 6, 5; Jennifer Flandermeyer, Great Plains Energy - Kansas City Power and Light Co., 1, 3, 6, 5; John Carlson, Great Plains Energy - Kansas

City Power and Light Co., 1, 3, 6, 5; Marcus Moor, Great Plains Energy - Kansas City Power and Light Co., 1, 3, 6, 5; - Douglas Webb, Group Name Westar-KCPL

Answer Yes

Document Name

Comment

Likes 0

Dislikes 0

Response

Larry Heckert - Alliant Energy Corporation Services, Inc. - 4

Answer Yes

Document Name

Comment

Likes 0

Dislikes 0

Response

Line Dufour - Hydro-Quebec Production - 6 - NPCC

Answer Yes

Document Name

Comment

Likes 0

Dislikes 0

Response

Chantal Mazza - Hydro-Quebec TransEnergie - 2 - NPCC

Answer Yes

Document Name

Comment

Likes 0

Dislikes 0

Response

Constantin Chitescu - Ontario Power Generation Inc. - 5

Answer

Yes

Document Name

Comment

Likes 0

Dislikes 0

Response

Chris Gowder - Florida Municipal Power Agency - 5, Group Name FMPA

Answer

Yes

Document Name

Comment

Likes 0

Dislikes 0

Response

Trevor Tidwell - PNM Resources - Public Service Company of New Mexico - 3

Answer

Yes

Document Name

Comment

Likes 0

Dislikes 0

Response

Pamela Hunter - Southern Company - Southern Company Services, Inc. - 1,3,5,6 - SERC, Group Name Southern Company	
Answer	Yes
Document Name	
Comment	
Likes 0	
Dislikes 0	
Response	
Teresa Cantwell - Lower Colorado River Authority - 5	
Answer	Yes
Document Name	
Comment	
Likes 0	
Dislikes 0	
Response	
Wayne Guttormson - SaskPower - 1	
Answer	Yes
Document Name	
Comment	
Likes 0	
Dislikes 0	
Response	

6. Do you agree that the proposed modifications provide a cost-effective means of addressing issues identified in the SAR? If not, please provide an alternative, more cost-effective manner in which to achieve at least an equivalent level of reliability.

Marty Hostler - Northern California Power Agency - 5

Answer No

Document Name

Comment

More studies and work have to be done. We really need a Standards process that is standard and thoughtfully implemented. It appears Standard modifications are coming out too quickly and causing inefficiencies in redoing work already done. (Standards efficiency project?)

NERC should provide a redline showing the difference between the new proposed standard and the existing standard first.

NERC should provide a list detailing studies GO's already did, versus what needs to be redone to comply with the proposed standard.

AND provide an honest cost estimate of redoing studies.

Likes 0

Dislikes 0

Response

Sean Bodkin - Dominion - Dominion Resources, Inc. - 6, Group Name Dominion

Answer No

Document Name

Comment

Since the comment form does not provide for 'other' or 'additional' comments related to the proposed PRC-024 changes, Dominion Energy is submitting the following comments under this section: 1) Additional clarity around whether the boundary for voltage ride through is part of the no-trip zone or not. This is unclear on the curves and different Regions have interpreted this differently. 2) The revised standard and guidance documents do not address issues, specifically the reflection process, outlined in the NERC Inverter Based Resource Performance Guide that blurs 1.0 per unit inverter voltage (based on inverter rated voltage) and 2) POI voltage in per unit, and appears to equate them. If this is the intent then it should be clearly stated in the revised standard or associated guidance documents. Dominion Energy recommends it be clearly stated that in lieu of reflection voltage, GOs should be allowed to use inverter rated voltage as being equivalent to POI voltage; or allow inverter skid settings to ride the line due to the fact that simulation results illustrate inverter schemes are completely restrained for system POI voltages along the LVRT boundary in PRC-024 Attachment 2.

Likes 1

Northern California Power Agency, 5, Hostler Marty

Dislikes 0

Response

Rachel Coyne - Texas Reliability Entity, Inc. - 10

Answer	No
Document Name	
Comment	
Texas RE does not have comments on this question.	
Likes	0
Dislikes	0

Response

Siddharth Pant - GE - General Electric Power Systems - NA - Not Applicable - NA - Not Applicable

Answer	No
Document Name	
Comment	

All the items below can be addressed by clarifications or corrections. They are a possible cause for confusion as stated in the current draft.

ITEM 1:

PRC-024-2 note 3 in Attachment 2 clarified that the times in the voltage/time curves were cumulative. The SAR had asked for clarifications with respect to start/stop/reset times while leaving cumulative in the verbiage. With the removal of “cumulative” from the voltage/time curves in the draft, there is room for mis-interpretation of the requirements, unless some interpretation guidance is also included. Is it a voltage vs. time profile as given in other grid codes? In other words, does it represent the “worst case” voltage as would be observed on an oscilloscope? Or, should it be interpreted some other way?

As an example, for an rms voltage with the following profile (very extreme, but just to make a point):

- a. $t < 0, V = 1$
- b. $0 \leq t < 0.1 \text{ sec}, V = 0$
- c. $0.1 \text{ sec} \leq t < 1 \text{ sec}, V = 1$
- d. $1 \text{ sec} \leq t < 1.06 \text{ sec}, V = 0$
- e. $1.06 \text{ sec} \leq t \leq 4 \text{ sec}, V = 1$

With “cumulative” in the description, the above curve would be interpreted as falling outside of the “No Trip Zone” of PRC-024-2 as the total time when the voltage is below 0.45 pu is 0.16 sec. What would be the interpretation in the draft PRC-024?

To carry this to an even more extreme, if the voltage was essentially toggling between 1 and 0 every 0.1 sec, that would clearly be outside the “No Trip Zone” of PRC-024-2. How should it be interpreted in the current draft?

ITEM 2:

Attachment 2 - The voltage ride-through figure includes ERCOT in the caption. However, the voltage profile in the ERCOT Nodal Operating Guide Section 2 is different from that in the draft PRC-024 (the HV portion in both curves is the same, the LV portion is different). Is this based on knowledge

that ERCOT will be changing their voltage curves to those shown in PRC-024? If not, ERCOT should be treated as a Regional Variance like that done for the Quebec Interconnection. Again, if the release of PRC-024-3 and ERCOT updates are not coordinated, there will be a lack of clarity and possible errors in setting.

ITEM 3:

B.R2 – Under certain conditions of large power production and large voltage dips, to protect itself from destructive overcurrents, an inverter may have to stop producing current for up to 20 ms at the start of the voltage dip. It will then very rapidly ramp back to the current reference values in up to an additional 50 ms. Note this reduction in current is only for a maximum time of 70 ms and not for the duration of the voltage dip. Is such a self-protective fast recovery period of low current considered “cease injecting current”? Will it require documentation under R3?

Note also that this is different from an inverter ceasing to inject current for the duration of the voltage dip and then ramping current after voltage recovery over a 500 ms to 1 second period.

ITEM 4:

In some cases, the clean copy of the draft is different from the redlined version.

Page 7 of clean draft -

Violation Severity Level Tables

R1 - In the Severe VSL cell, the redline document uses terminology “cease injecting current”, the clean document uses terminology “enter momentary cessation”.

R2 - In the Severe VSL cell, the redline document uses terminology “cease injecting current”, the clean document uses terminology “enter momentary cessation”.

Page 11 of clean draft

D.A.2 - In the Severe VSL cell, the redline document uses terminology “cease injecting current”, then clean document uses terminology “enter momentary cessation”.

Likes 0

Dislikes 0

Response

Donald Lynd - CMS Energy - Consumers Energy Company - 1

Answer

No

Document Name

Comment

I did not notice any comments in the SAR addressing a need to change the section “Evaluating Protective Relay Settings” in Attachment 2. In this section the drafting team has removed the option of using the assumptions that the units are at full nameplate real-power output and the power factor is 0.95 lagging. I assume that anyone who previously completed their evaluations using these assumptions would need to reevaluate using the most

probable real and reactive loading conditions. This could be a significant expense, particularly for those who contracted the original work and would effectively be starting over. Allowing use of the previous assumptions should provide a similar level of reliability without the added cost.

On a related note, item 'a' in this section provides instruction regarding the unit under study, but there is no longer clear instruction for the loading of other units connected to the same transformer.

Also related to cost, our existing documentation for wind turbines provides a ride-through curve, but does not indicate when the unit will cease to inject current. For example, one manufacturer's documentation lists a ride-through time at zero percent voltage with a footnote that the converter may stop pulsing during this period. We have attempted to obtain information from one of our manufacturers in support of another NERC PRC Standard, without success to this point. For existing equipment, there is no guarantee the information necessary to comply with the proposed Standard can be obtained.

Likes	0
-------	---

Dislikes	0
----------	---

Response

Karl Blaszkowski - CMS Energy - Consumers Energy Company - 3

Answer	No
---------------	----

Document Name	
----------------------	--

Comment

: I did not notice any comments in the SAR addressing a need to change the section "Evaluating Protective Relay Settings" in Attachment 2. In this section the drafting team has removed the option of using the assumptions that the units are at full nameplate real-power output and the power factor is 0.95 lagging. I assume that anyone who previously completed their evaluations using these assumptions would need to reevaluate using the most probable real and reactive loading conditions. This could be a significant expense, particularly for those who contracted the original work and would effectively be starting over. Allowing use of the previous assumptions should provide a similar level of reliability without the added cost.

On a related note, item 'a' in this section provides instruction regarding the unit under study, but there is no longer clear instruction for the loading of other units connected to the same transformer.

Also related to cost, our existing documentation for wind turbines provides a ride-through curve, but does not indicate when the unit will cease to inject current. For example, one manufacturer's documentation lists a ride-through time at zero percent voltage with a footnote that the converter may stop pulsing during this period. We have attempted to obtain information from one of our manufacturers in support of another NERC PRC Standard, without success to this point. For existing equipment, there is no guarantee the information necessary to comply with the proposed Standard can be obtained.

Likes	0
-------	---

Dislikes	0
----------	---

Response

Bridget Silvia - Sempra - San Diego Gas and Electric - 3

Answer	No
---------------	----

Document Name	
----------------------	--

Comment

Do not have enough information to determine if this will be cost-effective or not.

Likes 0

Dislikes 0

Response

Thomas Foltz - AEP - 5

Answer

No

Document Name

Comment

Because the current comment form provides no area for providing general feedback, or feedback regarding areas beyond those stated within the questions themselves, we have elected to provide such feedback in the response to this question.

AEP does not agree that the proposed modifications provide a cost-effective means of addressing issues in the SAR. AEP continues to recommend removing the reference to “high-side of generator step-up or collector transformer” and allow Generator Owners to utilize the point of interconnection as defined within the FERC filed Interconnection Service Agreement. AEP believes the SDT should take the opportunity to remain consistent with the currently enforceable versions of PRC-024 and FAC-008 and retain the reference to “point of interconnection” but remove the “clarifying text” which we believe instead describes a point of measurement. The definition as presented creates undue compliance burden on the Generator Owner and may negatively impact ride-through capability for renewable resources with generator interconnection facilities of considerable distance. Driven by these concerns, AEP has chosen to vote negative on the proposed draft.

While the currently posted “redline to last posted” document is indeed helpful for seeing the most recently proposed changes, we believe that it should be accompanied by an additional redlined document showing all currently proposed edits-to-date, both additions and deletions, using only the current version subject to enforcement as a baseline (i.e. “redline to last approved”). If only the most recently proposed revisions are shown, incorrect conclusions may be drawn by industry during their review. For example, in the “redline to last posted” document, text in black could be currently included in the version under enforcement or it could instead be text that was proposed in the previous draft but left unchanged in the latest draft. Similarly, text shown as deleted could be text recently proposed for deletion in the most recent draft, or instead could be text that was proposed for inclusion in the previous draft but then later struck in the latest draft.

Likes 1

Northern California Power Agency, 5, Hostler Marty

Dislikes 0

Response

Jeanne Kurzynowski - CMS Energy - Consumers Energy Company - 1,3,4,5 - RF

Answer

No

Document Name

Comment

I did not notice any comments in the SAR addressing a need to change the section “Evaluating Protective Relay Settings” in Attachment 2. In this section the drafting team has removed the option of using the assumptions that the units are at full nameplate real-power output and the power factor is 0.95 lagging. I assume that anyone who previously completed their evaluations using these assumptions would need to reevaluate using the most probable real and reactive loading conditions. This could be a significant expense, particularly for those who contracted the original work and would effectively be starting over. Allowing use of the previous assumptions should provide a similar level of reliability without the added cost.

On a related note, item ‘a’ in this section provides instruction regarding the unit under study, but there is no longer clear instruction for the loading of other units connected to the same transformer.

Also related to cost, our existing documentation for wind turbines provides a ride-through curve, but does not indicate when the unit will cease to inject current. For example, one manufacturer’s documentation lists a ride-through time at zero percent voltage with a footnote that the converter may stop pulsing during this period. We have attempted to obtain information from one of our manufacturers in support of another NERC PRC Standard, without success to this point. For existing equipment, there is no guarantee the information necessary to comply with the proposed Standard can be obtained.

Likes 0

Dislikes 0

Response

Pamela Hunter - Southern Company - Southern Company Services, Inc. - 1,3,5,6 - SERC, Group Name Southern Company

Answer

Yes

Document Name

Comment

If the existing protection equipment (other than discrete protective relays) are incapable of being set to comply with R1 and/or R2, they should not be required to be changed out and should be permitted to be included in the R3 exclusion option, which has been retained in the current draft.

Two other comments regarding the draft and the negative vote explanation:

First item: Changing the title of the standard implies that the scope of included F and V protection settings has been expanded to non-Generator protection items, e.g. mechanical (turbine), et. al. which used electrical signals in the detection/operation. Disagree with this expansion – no documented need for this change w.r.t. system reliability.

Second item: A.) Many generator owners, including this one, have already made inverter controls setting adjustments for inverter-based systems to permit ride-through capability with immediate or minimal delay to restart as a result of the recent NERC Alert recommendations on the subject.

B.) Industry standard P2800 is being written to ensure that future inverter-based electric generating equipment is built with these operational characteristics maximized for grid performance.

C.) A recent CAISO tariff amendment which targets mitigating reliability issues caused by inverter-based generators response to grid disturbances related to high voltage transmission system faults or transient voltage excursions. These changes to the tariff will provide the necessary changes to future inverter-based resources. These tariff revisions result from the CAISO’s most recent Interconnection Process Enhancements “IPE” stakeholder initiative. The Inverter-based resource task force, too, has issued recommended interconnect agreement suggestions for all transmission service providers to consider when agreeing to connect these types of resources to the grid.

The combination of each of these three factors (A, B, and C above) coupled with the absence of system control instability in the current state makes a sufficient case that these changes to PRC-024 are not needed at this time.

Likes 0

Dislikes 0

Response

Line Dufour - Hydro-Quebec Production - 6 - NPCC

Answer

Yes

Document Name

Comment

We have an additional comment about the draft RSAW that is shown on the project page. It doesn't include the two requirements D.A.2 and D.A.5 from the variance for the Quebec Interconnection.

Likes 0

Dislikes 0

Response

Jodirah Green - ACES Power Marketing - 1,3,4,5,6 - MRO,WECC,Texas RE,SERC,RF, Group Name ACES Standard Collaborations

Answer

Yes

Document Name

Comment

The new and revised language proposed for PRC-024-3 provide a cost-effective means of addressing the most pressing industry concerns expressed in comments to the SAR. ACES appreciates the efforts of NERC and the drafting team, and the opportunity to comment.

Likes 0

Dislikes 0

Response

Aaron Cavanaugh - Bonneville Power Administration - 1,3,5,6 - WECC

Answer

Yes

Document Name

Comment

None

Likes 0

Dislikes 0

Response

Amy Casuscelli - Amy Casuscelli On Behalf of: Carrie Dixon, Xcel Energy, Inc. , 6; Gerry Huitt, Xcel Energy, Inc., 1, 5, 3; - Amy Casuscelli

Answer

Yes

Document Name

Comment

Xcel Energy is supportive of the modifications proposed. We also submit the following reword of Footnote 4 to assist in readability: "Excludes limitations caused by the setting capability of the frequency and voltage protective relays for the generating resource(s). *This* does not exclude limitations originating in the equipment protected by the relays or frequency and voltage protection that is embedded in control systems."

Likes 0

Dislikes 0

Response

Wayne Guttormson - SaskPower - 1

Answer

Yes

Document Name

Comment

Likes 0

Dislikes 0

Response

Teresa Cantwell - Lower Colorado River Authority - 5

Answer

Yes

Document Name

Comment

Likes 0

Dislikes 0

Response

Trevor Tidwell - PNM Resources - Public Service Company of New Mexico - 3

Answer

Yes

Document Name

Comment

Likes 0

Dislikes 0

Response

Daniel Gacek - Exelon - 1

Answer

Yes

Document Name

Comment

Likes 0

Dislikes 0

Response

Constantin Chitescu - Ontario Power Generation Inc. - 5

Answer

Yes

Document Name

Comment

Likes 0

Dislikes 0

Response

Chantal Mazza - Hydro-Quebec TransEnergie - 2 - NPCC**Answer** Yes**Document Name****Comment**

Likes 0

Dislikes 0

Response**Larry Heckert - Alliant Energy Corporation Services, Inc. - 4****Answer** Yes**Document Name****Comment**

Likes 0

Dislikes 0

Response**Karie Barczak - DTE Energy - Detroit Edison Company - 3, Group Name DTE Energy - DTE Electric****Answer** Yes**Document Name****Comment**

Likes 0

Dislikes 0

Response**Ruida Shu - Northeast Power Coordinating Council - 1,2,3,4,5,6,7,8,9,10 - NPCC, Group Name RSC****Answer** Yes**Document Name****Comment**

Likes 0

Dislikes 0

Response

Glenn Barry - Los Angeles Department of Water and Power - 5

Answer

Yes

Document Name

Comment

Likes 0

Dislikes 0

Response

Bruce Reimer - Manitoba Hydro - 1

Answer

Yes

Document Name

Comment

Likes 0

Dislikes 0

Response

Nick Batty - Keys Energy Services - 9 - SERC

Answer

Yes

Document Name

Comment

Likes 0

Dislikes 0

Response

Jamie Monette - Allete - Minnesota Power, Inc. - 1

Answer	Yes
Document Name	
Comment	
Likes 0	
Dislikes 0	
Response	
Michael Goggin - Grid Strategies - 5 - NA - Not Applicable	
Answer	Yes
Document Name	
Comment	
Likes 0	
Dislikes 0	
Response	
Richard Jackson - U.S. Bureau of Reclamation - 1	
Answer	Yes
Document Name	
Comment	
Likes 0	
Dislikes 0	
Response	
Neil Swearingen - Salt River Project - 1,3,5,6 - WECC	
Answer	Yes
Document Name	
Comment	
Likes 0	

Dislikes 0

Response

Glen Farmer - Avista - Avista Corporation - 5

Answer

Yes

Document Name

Comment

Likes 0

Dislikes 0

Response

Davis Jelusich - Public Utility District No. 1 of Chelan County - 6, Group Name Public Utility District No. 1 of Chelan County

Answer

Yes

Document Name

Comment

Likes 0

Dislikes 0

Response

Maryanne Darling-Reich - Black Hills Corporation - 1,3,5,6 - MRO,WECC

Answer

Yes

Document Name

Comment

Likes 0

Dislikes 0

Response

Kim Thomas - Duke Energy - 1,3,5,6 - SERC,RF, Group Name Duke Energy

Answer

Yes

Document Name	
Comment	
Likes 0	
Dislikes 0	
Response	
Mark Garza - FirstEnergy - FirstEnergy Corporation - 4, Group Name FE Voter	
Answer	Yes
Document Name	
Comment	
Likes 0	
Dislikes 0	
Response	
Dana Klem - MRO - 1,2,3,4,5,6 - MRO, Group Name MRO NSRF	
Answer	Yes
Document Name	
Comment	
Likes 0	
Dislikes 0	
Response	
Kevin Conway - Public Utility District No. 1 of Pend Oreille County - 1,3,5,6	
Answer	Yes
Document Name	
Comment	
Likes 0	
Dislikes 0	

Response

Anthony Jablonski - ReliabilityFirst - 10

Answer Yes

Document Name

Comment

Likes 0

Dislikes 0

Response

Bette White - AES - Indianapolis Power and Light Co. - 3

Answer Yes

Document Name

Comment

Likes 0

Dislikes 0

Response

Michelle Amarantos - APS - Arizona Public Service Co. - 1

Answer Yes

Document Name

Comment

Likes 0

Dislikes 0

Response

Chris Wagner - Santee Cooper - 1, Group Name Santee Cooper

Answer Yes

Document Name

Comment	
Likes 0	
Dislikes 0	
Response	
Matthew Nutsch - Seattle City Light - 1,3,4,5,6 - WECC	
Answer	Yes
Document Name	
Comment	
Likes 0	
Dislikes 0	
Response	
Jonathan Robbins - Seminole Electric Cooperative, Inc. - 1,3,4,5,6	
Answer	
Document Name	PRC-024-2 - PRC-024-3 (Draft 2) Comments and Questions.docx
Comment	
See additional questions/comments attached.	
Likes 0	
Dislikes 0	
Response	
Douglas Webb - Douglas Webb On Behalf of: Allen Klassen, Westar Energy, 6, 3, 1, 5; Bryan Taggart, Westar Energy, 6, 3, 1, 5; Derek Brown, Westar Energy, 6, 3, 1, 5; Grant Wilkerson, Westar Energy, 6, 3, 1, 5; James McBee, Great Plains Energy - Kansas City Power and Light Co., 1, 3, 6, 5; Jennifer Flandermeyer, Great Plains Energy - Kansas City Power and Light Co., 1, 3, 6, 5; John Carlson, Great Plains Energy - Kansas City Power and Light Co., 1, 3, 6, 5; Marcus Moor, Great Plains Energy - Kansas City Power and Light Co., 1, 3, 6, 5; - Douglas Webb, Group Name Westar-KCPL	
Answer	
Document Name	
Comment	

Westar Energy and Kansas City Power & Light support the Edison Electric Institutes (EEI) Comments

Likes 0

Dislikes 0

Response

Consideration of Comments

Project Name:	2018-04 Modifications to PRC-024-2 PRC-024-3 (Draft 2)
Comment Period Start Date:	9/20/2019
Comment Period End Date:	11/4/2019
Associated Ballot:	2018-04 Modifications to PRC-024-2 PRC-024-3 AB 2 ST

There were 49 sets of responses, including comments from approximately 140 different people from approximately 106 companies representing 10 of the Industry Segments as shown in the table on the following pages.

All comments submitted can be reviewed in their original format on the [project page](#).

If you feel that your comment has been overlooked, please let us know immediately. Our goal is to give every comment serious consideration in this process. If you feel there has been an error or omission, you can contact Senior Director of Engineering and Standards [Howard Gugel](#) (via email) or at (404) 446-9693.

Questions

1. Based on industry feedback, the SDT removed the Transmission Owner (TO) from the Applicability (Functional Entities) of PRC-024-3. Do you agree with this change? If not, please provide the basis for your disagreement and a specific instance where not including the TO would present a risk to reliability.
2. Based on industry feedback, the SDT modified the Applicability (Facilities) to clarify both the types of 'protection' applicable, if activated, and the specific equipment the 'protection' is applied on. Do you agree with these changes? If not, please provide the basis for your disagreement and an alternate solution.
3. To address Scope Item 'f' from the approved SAR, the SDT added an exemption to the Applicability (Facilities) to clarify that all auxiliary equipment and associated protection(s) within the generating Facility are not applicable to the standard. Do you agree with the 'Exemption'? If not, please provide the basis for your disagreement and an alternate solution.
4. Based on industry feedback, the SDT replaced the 0.1 second 'Minimum Time (Sec)' value in the frequency tables with "Instantaneous" and provided additional clarity via Footnote #6 regarding frequency calculation/measurement. Do you agree with this change? If not, please provide the basis for your disagreement and an alternate solution.
5. Based on industry feedback, the SDT revised the Implementation Plan to provide twenty-four months for applicable entities to evaluate settings, make changes for applicable equipment, and purchase necessary equipment, if necessary. Do you agree with the revised Implementation Plan? If not, please provide the basis for your disagreement and an alternate proposal.
6. Do you agree that the proposed modifications provide a cost-effective means of addressing issues identified in the SAR? If not, please provide an alternative, more cost-effective manner in which to achieve at least an equivalent level of reliability.

The Industry Segments are:

- 1 — Transmission Owners
- 2 — RTOs, ISOs
- 3 — Load-serving Entities
- 4 — Transmission-dependent Utilities
- 5 — Electric Generators
- 6 — Electricity Brokers, Aggregators, and Marketers
- 7 — Large Electricity End Users
- 8 — Small Electricity End Users
- 9 — Federal, State, Provincial Regulatory or other Government Entities
- 10 — Regional Reliability Organizations, Regional Entities

Organization Name	Name	Segment(s)	Region	Group Name	Group Member Name	Group Member Organization	Group Member Segment(s)	Group Member Region
Florida Municipal Power Agency	Chris Gowder	5	FRCC	FMPPA	Carol Chinn	Florida Municipal Power Agency	4	SERC
					Richard Montgomery	Florida Municipal Power Agency	6	SERC
					Michelle Johnson	Florida Municipal Power Agency	3	SERC
					Don Cuevas	Beaches Energy Services	1	SERC
					David Owens	Gainesville Regional Utilities	1	SERC
					Steven Lancaster	Beaches Energy Services	3	SERC
					Darko Kovac	Gainesville Regional Utilities	3	SERC
					Neville Bowen	Ocala Utility Services	3	SERC

Organization Name	Name	Segment(s)	Region	Group Name	Group Member Name	Group Member Organization	Group Member Segment(s)	Group Member Region
					Nick Batty	Keys Energy Services	4	SERC
					Tom Reedy	Florida Municipal Power Pool	6	SERC
Santee Cooper	Chris Wagner	1		Santee Cooper	Rene' Free	Santee Cooper	1,3,5,6	SERC
					Debbie Schneider	Santee Cooper	1,3,5,6	SERC
					Bridget Coffman	Santee Cooper	1,3,5,6	SERC
MRO	Dana Klem	1,2,3,4,5,6	MRO	MRO NSRF	Joseph DePoorter	Madison Gas & Electric	3,4,5,6	MRO
					Larry Heckert	Alliant Energy	4	MRO
					Michael Brytowski	Great River Energy	1,3,5,6	MRO
					Jodi Jensen	Western Area Power Administration	1,6	MRO
					Andy Crooks	SaskPower Corporation	1	MRO
					Bryan Sherrow	Kansas City Board of Public Utilities	1	MRO

Organization Name	Name	Segment(s)	Region	Group Name	Group Member Name	Group Member Organization	Group Member Segment(s)	Group Member Region
					David Heins	Omaha Public Power District	1,3,5,6	MRO
					Jeremy Voll	Basin Electric Power Cooperative	1	MRO
					David Zwergel	Midcontinent ISO	2	MRO
					Douglas Webb	Kansas City Power & Light	1,3,5,6	MRO
					Fred Meyer	Algonquin Power Co.	1	MRO
					James Nail	Independence Power & Light (Independence Missouri)	1,3,5	MRO
					James Williams	Southwest Power Pool, Inc.	2	MRO
					Jamie Monette	Minnesota Power / ALLETE	1	MRO
					Jamison Cawley	Nebraska Public Power	1,3,5	MRO

Organization Name	Name	Segment(s)	Region	Group Name	Group Member Name	Group Member Organization	Group Member Segment(s)	Group Member Region
					Sing Tay	Oklahoma Gas & Electric	1,3,5,6	MRO
					Terry Harbour	MidAmerican Energy	1,3	MRO
					Troy Brumfield	American Transmission Company	1	MRO
Public Utility District No. 1 of Chelan County	Davis Jelusich	6		Public Utility District No. 1 of Chelan County	Joyce Gundry	Public Utility District No. 1 of Chelan County	3	WECC
					Jeff Kimbell	Public Utility District No. 1 of Chelan County	1	WECC
					Meaghan Connell	Public Utility District No. 1 of Chelan County	5	WECC
					Davis Jelusich	Public Utility District No. 1 of Chelan County	6	WECC
Douglas Webb	Douglas Webb		MRO,SPP RE	Westar-KCPL	Doug Webb	Westar	1,3,5,6	MRO
					Doug Webb	KCP&L	1,3,5,6	MRO

Organization Name	Name	Segment(s)	Region	Group Name	Group Member Name	Group Member Organization	Group Member Segment(s)	Group Member Region
ACES Power Marketing	Jodirah Green	1,3,4,5,6	MRO,NA - Not Applicable,RF,SERC,Texas RE,WECC	ACES Standard Collaborations	Bob Solomon	Hoosier Energy Rural Electric Cooperative, Inc.	1	SERC
					Kevin Lyons	Central Iowa Power Cooperative	1	MRO
					Bill Hutchison	Southern Illinois Power Cooperative	1	SERC
					Tara Lightner	Sunflower Electric Power Corporation	1	MRO
					Jenny Knernshield	Old Dominion Electric Cooperative	3,4	SERC
DTE Energy - Detroit Edison Company	Karie Barczak	3		DTE Energy - DTE Electric	Jeffrey Depriest	DTE Energy - DTE Electric	5	RF
					Daniel Herring	DTE Energy - DTE Electric	4	RF
					Karie Barczak	DTE Energy - DTE Electric	3	RF
Duke Energy		1,3,5,6	FRCC,RF,SERC	Duke Energy	Laura Lee	Duke Energy	1	SERC

Organization Name	Name	Segment(s)	Region	Group Name	Group Member Name	Group Member Organization	Group Member Segment(s)	Group Member Region
	Kim Thomas				Dale Goodwine	Duke Energy	5	SERC
					Greg Cecil	Duke Energy	6	RF
FirstEnergy - FirstEnergy Corporation	Mark Garza	4		FE Voter	Julie Severino	FirstEnergy - FirstEnergy Corporation	1	RF
					Aaron Ghodooshim	FirstEnergy - FirstEnergy Corporation	3	RF
					Robert Loy	FirstEnergy - FirstEnergy Solutions	5	RF
					Ann Carey	FirstEnergy - FirstEnergy Solutions	6	RF
					Mark Garza	FirstEnergy-FirstEnergy	4	RF
Southern Company - Southern Company Services, Inc.	Pamela Hunter	1,3,5,6	SERC	Southern Company	Adrienne Collins	Southern Company - Southern Company Services, Inc.	1	SERC
					Joel Dembowski	Southern Company - Alabama	3	SERC

Organization Name	Name	Segment(s)	Region	Group Name	Group Member Name	Group Member Organization	Group Member Segment(s)	Group Member Region
						Power Company		
					William D. Shultz	Southern Company Generation	5	SERC
					Ron Carlsen	Southern Company - Southern Company Generation	6	SERC
Northeast Power Coordinating Council	Ruida Shu	1,2,3,4,5,6,7,8,9,10	NPCC	RSC	Guy V. Zito	Northeast Power Coordinating Council	10	NPCC
					Randy MacDonald	New Brunswick Power	2	NPCC
					Glen Smith	Entergy Services	4	NPCC
					Brian Robinson	Utility Services	5	NPCC
					Alan Adamson	New York State Reliability Council	7	NPCC

Organization Name	Name	Segment(s)	Region	Group Name	Group Member Name	Group Member Organization	Group Member Segment(s)	Group Member Region
					David Burke	Orange & Rockland Utilities	3	NPCC
					Michele Tondalo	UI	1	NPCC
					Helen Lainis	IESO	2	NPCC
					Sean Cavote	PSEG	4	NPCC
					Kathleen Goodman	ISO-NE	2	NPCC
					David Kiguel	Independent	NA - Not Applicable	NPCC
					Silvia Mitchell	NextEra Energy - Florida Power and Light Co.	6	NPCC
					Paul Malozewski	Hydro One Networks, Inc.	3	NPCC
					Nick Kowalczyk	Orange and Rockland	1	NPCC
					Joel Charlebois	AESI - Acumen Engineered Solutions International Inc.	5	NPCC

Organization Name	Name	Segment(s)	Region	Group Name	Group Member Name	Group Member Organization	Group Member Segment(s)	Group Member Region
					Mike Cooke	Ontario Power Generation, Inc.	4	NPCC
					Salvatore Spagnolo	New York Power Authority	1	NPCC
					Shivaz Chopra	New York Power Authority	5	NPCC
					Mike Forte	Con Ed - Consolidated Edison	4	NPCC
					Dermot Smyth	Con Ed - Consolidated Edison Co. of New York	1	NPCC
					Peter Yost	Con Ed - Consolidated Edison Co. of New York	3	NPCC
					Ashmeet Kaur	Con Ed - Consolidated Edison	5	NPCC
					Caroline Dupuis	Hydro Quebec	1	NPCC

Organization Name	Name	Segment(s)	Region	Group Name	Group Member Name	Group Member Organization	Group Member Segment(s)	Group Member Region
					Chantal Mazza	Hydro Quebec	2	NPCC
					Sean Bodkin	Dominion - Dominion Resources, Inc.	6	NPCC
					Laura McLeod	NB Power Corporation	5	NPCC
					Randy MacDonald	NB Power Corporation	2	NPCC
					Gregory Campoli	New York Independent System Operator	2	NPCC
					John Hastings	National Grid	1	NPCC
					Quintin Lee	Eversource Energy	1	NPCC
					Michael Jones	National Grid USA	1	NPCC
Dominion - Dominion Resources, Inc.	Sean Bodkin	6		Dominion	Connie Lowe	Dominion - Dominion Resources, Inc.	3	NA - Not Applicable

Organization Name	Name	Segment(s)	Region	Group Name	Group Member Name	Group Member Organization	Group Member Segment(s)	Group Member Region
					Lou Oberski	Dominion - Dominion Resources, Inc.	5	NA - Not Applicable
					Larry Nash	Dominion - Dominion Virginia Power	1	NA - Not Applicable
					Rachel Snead	Dominion - Dominion Resources, Inc.	5	NA - Not Applicable

1. Based on industry feedback, the SDT removed the Transmission Owner (TO) from the Applicability (Functional Entities) of PRC-024-3. Do you agree with this change? If not, please provide the basis for your disagreement and a specific instance where not including the TO would present a risk to reliability.

Dennis Chastain - Tennessee Valley Authority - 1,3,5,6 - SERC

Answer No

Document Name

Comment

How does it make sense that GSUs owned by GOs are in scope, but GSUs owned by TOs are not? Are GSUs owned by TOs less of a risk to the BES?

Likes 0

Dislikes 0

Response

Thank you for your comment. The SDT reached out to industry in attempt to quantify the risk of not requiring PRC-024 protection setting requirements on GSUs owned by entities registered as TOs. Other than in the Quebec Interconnect, no instances were identified where a GSU was owned by an entity registered as a TO and not also registered as a GO. As such, the SDT determined that there would be no reliability risk by continuing to exclude TOs from the Applicability (except for Quebec) and therefore, to include TOs as an Applicable Functional Entity would add unnecessary compliance burden on TOs to document their non-ownership of GSUs.

Kim Thomas - Duke Energy - 1,3,5,6 - SERC,RF, Group Name Duke Energy

Answer No

Document Name

Comment

Some Transmission Owners (TO) apply voltage and frequency trip settings at the Point of Interconnection that trip generation based on PRC-024 voltage and frequency requirements, particularly for inverter-based resources tapped onto network transmission lines. These TO's typically have the same functionality applied by the Generator Owner (GO). This arrangement would suggest that both the GO and TO should comply with PRC-024. If the TO is not required to comply with PRC-024, it could trip a generating plant quicker than required by PRC-024.

Likes 0

Dislikes 0

Response

Thank you for your comment. Inclusion of voltage and frequency relays applied on transmission lines is outside of the PRC-024-3 SAR and the PRC-024-3 Supplemental SAR.

Rachel Coyne - Texas Reliability Entity, Inc. – 10

Answer

No

Document Name

Comment

Although it is uncommon for the TO to own the generator step-up (GSU) or main power transformer (MPT), in cases where to TO does own the GSU or MPT the TO should be required to take steps to ensure the generator rides through voltage and frequency excursions as prescribed within the Standard.

Likes 0

Dislikes 0

Response

Thank you for your comment. The SDT reached out to industry in attempt to quantify the risk of not requiring PRC-024 protection setting requirements on GSUs owned by entities registered as TOs. Other than in the Quebec Interconnect, no instances were identified where a GSU was owned by an entity registered as a TO and not also registered as a GO. As such, the SDT determined that there would be no

reliability risk by continuing to exclude TOs from the Applicability (except for Quebec) and therefore, to include TOs as an Applicable Functional Entity would add unnecessary compliance burden on TOs to document their non-ownership of GSUs.

Marty Hostler - Northern California Power Agency – 5

Answer No

Document Name

Comment

Why are TO's GSU protection not included but GO's GSUs are? Also see DUKE, and TRE.

Likes 0

Dislikes 0

Response

Thank you for your comment. The SDT reached out to industry in attempt to quantify the risk of not requiring PRC-024 protection setting requirements on GSUs owned by entities registered as TOs. Other than in the Quebec Interconnect, no instances were identified where a GSU was owned by an entity registered as a TO and not also registered as a GO. As such, the SDT determined that there would be no reliability risk by continuing to exclude TOs from the Applicability (except for Quebec) and therefore, to include TOs as an Applicable Functional Entity would add unnecessary compliance burden on TOs to document their non-ownership of GSUs.

Michelle Amarantos - APS - Arizona Public Service Co. – 1

Answer Yes

Document Name

Comment

AZPS appreciates that this was changed.

Likes 0

Dislikes 0

Response	
Thank you for your comment.	
Dana Klem - MRO - 1,2,3,4,5,6 - MRO, Group Name MRO NSRF	
Answer	Yes
Document Name	
Comment	
<p>The NSRF has concerns with the term “main power transformer (MPT)”. This term is not included in the NERC Glossary of Terms, nor is it well defined in this proposed revision to PRC-024-3. It is introduced as a part of the inclusion of the TO Functional Entity requirement limited to the Quebec Interconnection, yet it is included in the text of Requirement 2 as well as Attachment 2, applicable to the Eastern, Western, and ERCOT Interconnections in the United States. The NSRF requests that the inclusion of this new term in this Standard be reversed, or a formal definition of the term be provided in the Standard or NERC Glossary of Terms.</p>	
Likes 1	Alliant Energy Corporation Services, Inc., 4, Heckert Larry
Dislikes 0	
Response	
Thank you for your comment. The drafting team believes that the term “main power transformer (MPT)” is used broadly throughout the dispersed generation industry. The SDT has added a footnote to more clearly establish its intent in the use of the term “main power transformer (MPT).”	
Maryanne Darling-Reich - Black Hills Corporation - 1,3,5,6 - MRO,WECC	
Answer	Yes
Document Name	
Comment	
BHC agrees with EEI’s comments as submitted	
Likes 0	

Dislikes	0
Response	
Please see response to EEI.	
Aaron Cavanaugh - Bonneville Power Administration - 1,3,5,6 - WECC	
Answer	Yes
Document Name	
Comment	
<p>BPA is supportive of the proposed change. BPA would like to point out for consideration that this change could possibly be creating a loophole under the following scenario.</p> <p><i>If a Generator Owner installs a GSU on a new project that does not meet the requirements outlined in the standard, they could potentially decide with a Transmission Owner, to make the ownership change on the low side, essentially giving the GSU to a non-Quebec Transmission Owner.</i></p> <p><i>If this scenario played out, would the non-Quebec Transmission Owner not need to consider the protection of that GSU for this standard?</i></p> <p>Perhaps this is a far-fetched scenario but it was a thought that came to mind regarding this change. The BPA subject matter experts that reviewed this standard do not see this hypothetical loophole as a measurable risk to reliability that would justify a disagreement with the change. BPA only wants to share the thought for others to consider.</p>	
Likes	0
Dislikes	0
Response	
Thank you for your comment.	
Glen Farmer - Avista - Avista Corporation - 5	
Answer	Yes
Document Name	

Comment	
agree with EEI Comments.	
Likes	0
Dislikes	0
Response	
Please see response to EEI.	
Glenn Barry - Los Angeles Department of Water and Power - 5	
Answer	Yes
Document Name	
Comment	
There is concern for addressing frequency protection settings for inerties on transmission lines. Because PRC-024 applies to generating resources, should this concern be addressed in PRC-024 or in a separate Standard?	
Likes	0
Dislikes	0
Response	
Thank you for your comment. Inclusion of voltage and frequency relays applied on transmission lines is outside of the PRC-024-3 SAR and the PRC-024-3 Supplemental SAR.	
Mark Gray - Edison Electric Institute - NA - Not Applicable - NA - Not Applicable	
Answer	Yes
Document Name	
Comment	

<p>EEI supports the removal of Transmission Owners (TOs) from the Applicability Section of this Reliability Standard believing that this change is consistent with the purpose of the standard and how TOs operate throughout the US.</p>	
Likes	0
Dislikes	0
Response	
<p>Thank you for your comment.</p>	
<p>Douglas Webb - Douglas Webb On Behalf of: Allen Klassen, Westar Energy, 6, 3, 1, 5; Bryan Taggart, Westar Energy, 6, 3, 1, 5; Derek Brown, Westar Energy, 6, 3, 1, 5; Grant Wilkerson, Westar Energy, 6, 3, 1, 5; James McBee, Great Plains Energy - Kansas City Power and Light Co., 1, 3, 6, 5; Jennifer Flandermeyer, Great Plains Energy - Kansas City Power and Light Co., 1, 3, 6, 5; John Carlson, Great Plains Energy - Kansas City Power and Light Co., 1, 3, 6, 5; Marcus Moor, Great Plains Energy - Kansas City Power and Light Co., 1, 3, 6, 5; - Douglas Webb, Group Name Westar-KCPL</p>	
Answer	Yes
Document Name	
Comment	
<p>Westar Energy and Kansas City Power & Light support the Edison Electric Institutes (EEI) Comments.</p>	
Likes	0
Dislikes	0
Response	
<p>Please see response to EEI.</p>	
<p>Larry Heckert - Alliant Energy Corporation Services, Inc. - 4</p>	
Answer	Yes

Document Name	
Comment	
<p>Support the MRO NSRF Comments, as follows:</p> <p>The NSRF has concerns with the term “main power transformer (MPT)”. This term is not included in the NERC Glossary of Terms, nor is it well defined in this proposed revision to PRC-024-3. It is introduced as a part of the inclusion of the TO Functional Entity requirement limited to the Quebec Interconnection, yet it is included in the text of Requirement 2 as well as Attachment 2, applicable to the Eastern, Western, and ERCOT Interconnections in the United States. The NSRF requests that the inclusion of this new term in this Standard be reversed, or a formal definition of the term be provided in the Standard or NERC Glossary of Terms.</p>	
Likes	0
Dislikes	0
Response	
Please see response to the MRO NSRF.	
Chantal Mazza - Hydro-Quebec TransEnergie - 2 - NPCC	
Answer	Yes
Document Name	PRC-024-3 HQ comments.docx
Comment	
<p>Hydro-Quebec supports the comments submitted by the RSC.</p> <p>In addition, Hydro-Quebec has the following comments :</p> <ul style="list-style-type: none"> Review and clarify footnote #4 associated with Requirement #3. The last part that was added regarding the protection imbedded in control systems for IBRs brings some confusion as it relates to the protection system itself while the first part of the sentence relates to the equipment that is protected: “Excludes limitations caused by the setting capability of the frequency and voltage protective relays for 	

the generating resource(s) but does not exclude limitations originating in the equipment protected by the relays or frequency and voltage protection embedded in control systems.”

· In Attachment 1, we recommend adding the distinct over frequency requirement (curve) that currently applies to thermal generation and IBRs in the Quebec Interconnection . Please see attached file.

Likes 0

Dislikes 0

Response

Thank you for your comment. See the Q4 response for RSC comments.

The SDT has made changes to new footnote #6 to address this concern.

Regarding Attachment 1 comment, this is not currently in the scope of Project 2018-04.

Daniel Gacek - Exelon - 1

Answer

Yes

Document Name

Comment

Exelon supports the SDTs decision to limit applicability to functional entities that apply the protection systems that are the subject of the standard.

On behalf of Exelon, Segments 1, 3, 5, 6

Likes 0

Dislikes 0

Response

Thank you for your comment.

Wayne Guttormson - SaskPower - 1	
Answer	Yes
Document Name	
Comment	
Support the MRO NSRF comments.	
Likes	0
Dislikes	0
Response	
Please see the response to MRO NSRF.	
Matthew Nutsch - Seattle City Light - 1,3,4,5,6 - WECC	
Answer	Yes
Document Name	
Comment	
Likes	0
Dislikes	0
Response	
Chris Wagner - Santee Cooper - 1, Group Name Santee Cooper	
Answer	Yes
Document Name	
Comment	

Likes 0	
Dislikes 0	
Response	
Bette White - AES - Indianapolis Power and Light Co. - 3	
Answer	Yes
Document Name	
Comment	
Likes 0	
Dislikes 0	
Response	
Jeanne Kurzynowski - CMS Energy - Consumers Energy Company - 1,3,4,5 - RF	
Answer	Yes
Document Name	
Comment	
Likes 0	
Dislikes 0	
Response	

Leonard Kula - Independent Electricity System Operator - 2	
Answer	Yes
Document Name	
Comment	
Likes 0	
Dislikes 0	
Response	
Anthony Jablonski - ReliabilityFirst - 10	
Answer	Yes
Document Name	
Comment	
Likes 0	
Dislikes 0	
Response	
Thomas Foltz - AEP - 5	
Answer	Yes
Document Name	
Comment	

Likes	0
Dislikes	0
Response	
Kevin Conway - Public Utility District No. 1 of Pend Oreille County - 1,3,5,6	
Answer	Yes
Document Name	
Comment	
Likes	0
Dislikes	0
Response	
Bridget Silvia - Sempra - San Diego Gas and Electric - 3	
Answer	Yes
Document Name	
Comment	
Likes	0
Dislikes	0
Response	
Mark Garza - FirstEnergy - FirstEnergy Corporation - 4, Group Name FE Voter	

Answer	Yes
Document Name	
Comment	
Likes 0	
Dislikes 0	
Response	
Karl Blaszkowski - CMS Energy - Consumers Energy Company - 3	
Answer	Yes
Document Name	
Comment	
Likes 0	
Dislikes 0	
Response	
Amy Casuscelli - Amy Casuscelli On Behalf of: Carrie Dixon, Xcel Energy, Inc. , 6; Gerry Huitt, Xcel Energy, Inc., 1, 5, 3; - Amy Casuscelli	
Answer	Yes
Document Name	
Comment	
Likes 0	

Dislikes	0
Response	
Donald Lynd - CMS Energy - Consumers Energy Company - 1	
Answer	Yes
Document Name	
Comment	
Likes	0
Dislikes	0
Response	
Davis Jelusich - Public Utility District No. 1 of Chelan County - 6, Group Name Public Utility District No. 1 of Chelan County	
Answer	Yes
Document Name	
Comment	
Likes	0
Dislikes	0
Response	
Neil Swearingen - Salt River Project - 1,3,5,6 - WECC	
Answer	Yes

Document Name	
Comment	
Likes 0	
Dislikes 0	
Response	
Richard Jackson - U.S. Bureau of Reclamation - 1	
Answer	Yes
Document Name	
Comment	
Likes 0	
Dislikes 0	
Response	
Siddharth Pant - GE - General Electric Power Systems - NA - Not Applicable - NA - Not Applicable	
Answer	Yes
Document Name	
Comment	
Likes 0	
Dislikes 0	

Response	
Jamie Monette - Allete - Minnesota Power, Inc. - 1	
Answer	Yes
Document Name	
Comment	
Likes	0
Dislikes	0
Response	
Nick Batty - Keys Energy Services - 9 - SERC	
Answer	Yes
Document Name	
Comment	
Likes	0
Dislikes	0
Response	
Sean Bodkin - Dominion - Dominion Resources, Inc. - 6, Group Name Dominion	
Answer	Yes
Document Name	

Comment	
Likes 0	
Dislikes 0	
Response	
Bruce Reimer - Manitoba Hydro - 1	
Answer	Yes
Document Name	
Comment	
Likes 0	
Dislikes 0	
Response	
Armin Klusman - CenterPoint Energy Houston Electric, LLC - 1 - WECC	
Answer	Yes
Document Name	
Comment	
Likes 0	
Dislikes 0	
Response	

Ruida Shu - Northeast Power Coordinating Council - 1,2,3,4,5,6,7,8,9,10 - NPCC, Group Name RSC	
Answer	Yes
Document Name	
Comment	
Likes 0	
Dislikes 0	
Response	
Karie Barczak - DTE Energy - Detroit Edison Company - 3, Group Name DTE Energy - DTE Electric	
Answer	Yes
Document Name	
Comment	
Likes 0	
Dislikes 0	
Response	
Jodirah Green - ACES Power Marketing - 1,3,4,5,6 - MRO,WECC,Texas RE,SERC,RF, Group Name ACES Standard Collaborations	
Answer	Yes
Document Name	
Comment	

Likes 0	
Dislikes 0	
Response	
Constantin Chitescu - Ontario Power Generation Inc. - 5	
Answer	Yes
Document Name	
Comment	
Likes 0	
Dislikes 0	
Response	
Chris Gowder - Florida Municipal Power Agency - 5, Group Name FMPA	
Answer	Yes
Document Name	
Comment	
Likes 0	
Dislikes 0	
Response	

Trevor Tidwell - PNM Resources - Public Service Company of New Mexico - 3	
Answer	Yes
Document Name	
Comment	
Likes 0	
Dislikes 0	
Response	
Pamela Hunter - Southern Company - Southern Company Services, Inc. - 1,3,5,6 - SERC, Group Name Southern Company	
Answer	Yes
Document Name	
Comment	
Likes 0	
Dislikes 0	
Response	
Teresa Cantwell - Lower Colorado River Authority - 5	
Answer	Yes
Document Name	
Comment	

Likes	0
Dislikes	0
Response	
Line Dufour - Hydro-Quebec Production - 6 - NPCC	
Answer	
Document Name	
Comment	
N/A, For Quebec interconnection, TO is still part of the standards	
Likes	0
Dislikes	0
Response	
Thank you for your response.	

2. Based on industry feedback, the SDT modified the Applicability (Facilities) to clarify both the types of 'protection' applicable, if activated, and the specific equipment the 'protection' is applied on. Do you agree with these changes? If not, please provide the basis for your disagreement and an alternate solution.	
Pamela Hunter - Southern Company - Southern Company Services, Inc. - 1,3,5,6 - SERC, Group Name Southern Company	
Answer	No
Document Name	

Comment

Paragraph 4.2.1.5 includes items not included in the BES definition document and should not be included in the scope of PRC-024. Paragraph 4.2.1.4 should be the limit of the scope of equipment covered by PRC-024 for inverter-based resources.

Likes 0

Dislikes 0

Response

Thank you for your comment, the SDT believes that this is not a change from PRC-024-2.

Chris Gowder - Florida Municipal Power Agency - 5, Group Name FMMPA

Answer

No

Document Name

Comment

1. Main Power Transformer (MPT)- not defined anywhere. The intent was to replace “collector transformer”, but MPT is no better without context. Also, the term is defined in the Quebec-only language, then used in NERC-wide language.
2. Footnote seems to be adding unnecessary complexity.
3. Use of term capacity in the facility definition will lead to confusion, should just refer to BES definition Inclusion I4.

Likes 0

Dislikes 0

Response

Thank you for your comment.

1. The drafting team believes that the term “main power transformer (MPT)” is used broadly throughout the dispersed generation industry. The SDT has added a footnote to more clearly establish its intent in the use of the term “main power transformer (MPT).”
2. The SDT is unsure which footnote is being referred to but believes that all footnotes are needed.
3. The wording in 4.2.1.4 – 4.2.1.6 is intended to clarify what equipment is included and was previously described in PRC-024-2 footnote 4.

Constantin Chitescu - Ontario Power Generation Inc. - 5	
Answer	No
Document Name	
Comment	
<p>The terms “cease injecting current”, “cease current injection” and “momentary cessation” are not defined, nor commonly understood.</p> <p>Significant reduction of the amount of current being injected has a similar effect to momentary current cessation; they both deprive the grid of much needed support during the disturbance which negatively impacts grid reliability, and therefore, should not be an option, nor allowed without approval.</p> <p>Understanding the compounded effect on the grid of a multitude of inverters having similar design is important and accurate modelling may not be possible without adequate information regarding the amount of current being reduced.</p> <p>OPG recommends the terms “cease injecting current”, “cease current injection” and “momentary cessation”, used throughout the standard (applicable Facilities 4.2.1, R1, R2, applicable protection definition per footnote 3, D.A.2, Attachment 2a, etc.), to be replaced with “ceasing injecting current or significant reduction in current injection”.</p> <p>If this comment is adopted and implemented as such then there is a need to define the term “significant”.</p>	
Likes	0
Dislikes	0
Response	
Thank you for your comment.	
Marty Hostler - Northern California Power Agency - 5	
Answer	No
Document Name	
Comment	

See AEP, Duke, and TRE comments.	
Likes	0
Dislikes	0
Response	
Please see response to AEP, Duke and TRE comments.	
Armin Klusman - CenterPoint Energy Houston Electric, LLC - 1 - WECC	
Answer	No
Document Name	
Comment	
<p>CenterPoint Energy Houston Electric, LLC (CenterPoint Energy) disagrees with changing “collector transformer” to a newly developed term of “main power transformer (MPT)”. The use of “power” in the term tends to suggest a distribution substation power transformer instead of a transformer at a generation resource substation. A more applicable term would be ‘main step-up (MSU) transformer’. Other possible terms that could be considered are ‘main transformer (MT)’ or ‘station step-up (SSU) transformer’ which is used in the current draft of the Compliance Implementation Guidance PRC-019-2 that is being developed by a NERC Planning Committee task force. The term ‘main transformer’ is used in several places in the recently approved NERC Reliability Guideline – Improvements to Interconnection Requirements for BPS-Connected Inverter-Based Resources (September 2019). Regardless of what the collector transformer is renamed, CenterPoint Energy recommends adding a second figure in Attachment 2 (voltage ride-through) with a station sketch to provide clarity on Footnote 8: “Voltage at the high-side of the GSU or MPT.”</p>	
Likes	0
Dislikes	0
Response	

Thank you for your comment. The drafting team believes that the term “main power transformer (MPT)” is used broadly throughout the dispersed generation industry. The SDT has added a footnote to more clearly establish its intent in the use of the term “main power transformer (MPT).”

Rachel Coyne - Texas Reliability Entity, Inc. - 10

Answer No

Document Name

Comment

Applicable Facilities only address protection up to the GSU or MPT. However, Texas RE has noted voltage protection applied on lines interconnecting a generating Facility to a Transmission station where the line protection is set to trip within the “no-trip zone” of PRC-024-2 Attachment 2. Texas RE recommends the SDT not limit the Facilities that are applicable to the Standard and should include any voltage or frequency protection that would result in an inability of the generating resource to ride through a frequency or voltage excursion as prescribed in Attachment 1 and Attachment 2.

Likes 0

Dislikes 0

Response

Thank you for your comment. Inclusion of voltage and frequency relays applied on transmission lines is outside of the PRC-024-3 SAR and the PRC-024-3 Supplemental SAR.

Neil Swearingen - Salt River Project - 1,3,5,6 - WECC

Answer No

Document Name

Comment

SRP supports most of the changes to the Applicability section. However SRP requests the SDT clarify 4.2.1, specifically "functions within the associated control systems". The phrase may be interpreted to include exciter settings even though they are covered by PRC-019-2.

Likes	0
Dislikes	0
Response	
Thank you for your comment, the SDT believes voltage and frequency setting in excitation systems were previously included in PRC-024-2 footnote 1. For clarity this information has been moved to Facilities paragraph 4.2.1 in PRC-024-3.	
Kim Thomas - Duke Energy - 1,3,5,6 - SERC,RF, Group Name Duke Energy	
Answer	No
Document Name	
Comment	
Given Duke Energy's response to Question #1, PRC-024 should apply to equipment out to the Point of Interconnection.	
Likes	0
Dislikes	0
Response	
Thank you for your comment. Inclusion of voltage and frequency relays applied on transmission lines is outside of the PRC-024-3 SAR and the PRC-024-3 Supplemental SAR.	
Thomas Foltz - AEP - 5	
Answer	No
Document Name	
Comment	
The changes proposed to 4.2.1.5, specifically in regards to the text "to the point where those resources aggregate to greater than 75 MVA" may not be reflective of all real-world conditions given that the currently proposed scope has been pared back to the Generator Owner.	

Referencing a subset of the BES in the Facilities section seems to be a somewhat unorthodox approach in establishing the Facilities within scope.

Likes 0

Dislikes 0

Response

Thank you for your comment. The wording in 4.2.1.4 – 4.2.1.6 is intended to clarify what equipment is included and was previously described in PRC-024-2 footnote 4.

Daniel Gacek - Exelon - 1

Answer

Yes

Document Name

Comment

Microprocessor technology allows for protection elements to be embedded in a broad variety of control systems. Exelon agrees with the changes made to clarify applicability of the standard to all elements providing protection that is the subject of this standard.

Note that volts per hertz relays are identified within the Applicability Section, however Footnote 4 does not specifically reference volts per hertz relay. For consistency Exelon requests that Volts Per Hertz relays are included in Footnote 4.

On behalf of Exelon, Segments 1, 3, 5, 6

Likes 0

Dislikes 0

Response

Thank you for your comments. The SDT has made this change in the new footnote 6.

Douglas Webb - Douglas Webb On Behalf of: Allen Klassen, Westar Energy, 6, 3, 1, 5; Bryan Taggart, Westar Energy, 6, 3, 1, 5; Derek Brown, Westar Energy, 6, 3, 1, 5; Grant Wilkerson, Westar Energy, 6, 3, 1, 5; James McBee, Great Plains Energy - Kansas City Power and

Light Co., 1, 3, 6, 5; Jennifer Flandermeyer, Great Plains Energy - Kansas City Power and Light Co., 1, 3, 6, 5; John Carlson, Great Plains Energy - Kansas City Power and Light Co., 1, 3, 6, 5; Marcus Moor, Great Plains Energy - Kansas City Power and Light Co., 1, 3, 6, 5; - Douglas Webb, Group Name Westar-KCPL

Answer	Yes
---------------	-----

Document Name	
----------------------	--

Comment

Westar Energy and Kansas City Power & Light support the Edison Electric Institutes (EEI) Comments.

Likes 0	
---------	--

Dislikes 0	
------------	--

Response

See response to EEI’s comment.

Mark Gray - Edison Electric Institute - NA - Not Applicable - NA - Not Applicable

Answer	Yes
---------------	-----

Document Name	
----------------------	--

Comment

EEI supports the changes made to the Applicability (Facilities) section of PRC-024-3 (Draft 2) believing it accurately reflects those facilities within the US that should be covered under this Reliability Standard. However, one area that the SDT should investigate further is the proposed change from “collector transformer” to “main power transformer (MPT)”. This type of transformers is referenced using at least three different names in three different documents. (i.e., collector transformer – BES Definition; MPT – PRC-024-3 Draft 3 and SSU (Station Step-up) within Implementation Guidance (*Under development by the SPCS*) for PRC-019, pages 71 -73). EEI suggest that NERC and the various SDTs and committees agree on a single name, that is defined, in order to ensure consistency and avoid confusion.

EEI also notes that volts per hertz relays are specifically identified within the Applicability Section (4.2.1), however, in Footnote 4 these relays are not specifically identified. For consistency, EEI suggests making the following change to Footnote 4: (*indicated in bold below*)

Footnote 4: Excludes limitations caused by the setting capability of the frequency, **and** voltage **and volts per hertz** protective relays for the generating resource(s) but does not exclude limitations originating in the equipment that the relays protect or frequency and voltage protection imbedded in control systems.

Likes 0

Dislikes 0

Response

Thank you for your comments. The drafting team believes that the term “main power transformer (MPT)” is used broadly throughout the dispersed generation industry. The SDT has added a footnote to more clearly establish its intent in the use of the term “main power transformer (MPT).”

The SDT has made this change in the new footnote 6.

Aaron Cavanaugh - Bonneville Power Administration - 1,3,5,6 - WECC

Answer

Yes

Document Name

Comment

None

Likes 0

Dislikes 0

Response

Maryanne Darling-Reich - Black Hills Corporation - 1,3,5,6 - MRO,WECC

Answer

Yes

Document Name

Comment	
BHC agrees with EEI's comments as submitted	
Likes	0
Dislikes	0
Response	
See response to EEI.	
Wayne Guttormson - SaskPower - 1	
Answer	Yes
Document Name	
Comment	
Likes	0
Dislikes	0
Response	
Teresa Cantwell - Lower Colorado River Authority - 5	
Answer	Yes
Document Name	
Comment	
Likes	0
Dislikes	0

Response	
Trevor Tidwell - PNM Resources - Public Service Company of New Mexico - 3	
Answer	Yes
Document Name	
Comment	
Likes	0
Dislikes	0
Response	
Chantal Mazza - Hydro-Quebec TransEnergie - 2 - NPCC	
Answer	Yes
Document Name	
Comment	
Likes	0
Dislikes	0
Response	
Line Dufour - Hydro-Quebec Production - 6 - NPCC	
Answer	Yes
Document Name	

Comment	
Likes 0	
Dislikes 0	
Response	
Larry Heckert - Alliant Energy Corporation Services, Inc. - 4	
Answer	Yes
Document Name	
Comment	
Likes 0	
Dislikes 0	
Response	
Jodirah Green - ACES Power Marketing - 1,3,4,5,6 - MRO,WECC,Texas RE,SERC,RF, Group Name ACES Standard Collaborations	
Answer	Yes
Document Name	
Comment	
Likes 0	
Dislikes 0	
Response	

Karie Barczak - DTE Energy - Detroit Edison Company - 3, Group Name DTE Energy - DTE Electric	
Answer	Yes
Document Name	
Comment	
Likes 0	
Dislikes 0	
Response	
Ruida Shu - Northeast Power Coordinating Council - 1,2,3,4,5,6,7,8,9,10 - NPCC, Group Name RSC	
Answer	Yes
Document Name	
Comment	
Likes 0	
Dislikes 0	
Response	
Glenn Barry - Los Angeles Department of Water and Power - 5	
Answer	Yes
Document Name	
Comment	

Likes 0	
Dislikes 0	
Response	
Bruce Reimer - Manitoba Hydro - 1	
Answer	Yes
Document Name	
Comment	
Likes 0	
Dislikes 0	
Response	
Sean Bodkin - Dominion - Dominion Resources, Inc. - 6, Group Name Dominion	
Answer	Yes
Document Name	
Comment	
Likes 0	
Dislikes 0	
Response	

Nick Batty - Keys Energy Services - 9 - SERC	
Answer	Yes
Document Name	
Comment	
Likes 0	
Dislikes 0	
Response	
Jamie Monette - Allete - Minnesota Power, Inc. - 1	
Answer	Yes
Document Name	
Comment	
Likes 0	
Dislikes 0	
Response	
Michael Goggin - Grid Strategies - 5 - NA - Not Applicable	
Answer	Yes
Document Name	
Comment	

Likes	0
Dislikes	0
Response	
Siddharth Pant - GE - General Electric Power Systems - NA - Not Applicable - NA - Not Applicable	
Answer	Yes
Document Name	
Comment	
Likes	0
Dislikes	0
Response	
Richard Jackson - U.S. Bureau of Reclamation - 1	
Answer	Yes
Document Name	
Comment	
Likes	0
Dislikes	0
Response	
Glen Farmer - Avista - Avista Corporation - 5	

Answer	Yes
Document Name	
Comment	
Likes 0	
Dislikes 0	
Response	
Davis Jelusich - Public Utility District No. 1 of Chelan County - 6, Group Name Public Utility District No. 1 of Chelan County	
Answer	Yes
Document Name	
Comment	
Likes 0	
Dislikes 0	
Response	
Donald Lynd - CMS Energy - Consumers Energy Company - 1	
Answer	Yes
Document Name	
Comment	
Likes 0	

Dislikes	0
Response	
Amy Casuscelli - Amy Casuscelli On Behalf of: Carrie Dixon, Xcel Energy, Inc. , 6; Gerry Huitt, Xcel Energy, Inc., 1, 5, 3; - Amy Casuscelli	
Answer	Yes
Document Name	
Comment	
Likes	0
Dislikes	0
Response	
Karl Blaszkowski - CMS Energy - Consumers Energy Company - 3	
Answer	Yes
Document Name	
Comment	
Likes	0
Dislikes	0
Response	
Mark Garza - FirstEnergy - FirstEnergy Corporation - 4, Group Name FE Voter	
Answer	Yes

Document Name	
Comment	
Likes 0	
Dislikes 0	
Response	
Dana Klem - MRO - 1,2,3,4,5,6 - MRO, Group Name MRO NSRF	
Answer	Yes
Document Name	
Comment	
Likes 0	
Dislikes 0	
Response	
Dennis Chastain - Tennessee Valley Authority - 1,3,5,6 - SERC	
Answer	Yes
Document Name	
Comment	
Likes 0	
Dislikes 0	

Response	
Bridget Silvia - Sempra - San Diego Gas and Electric - 3	
Answer	Yes
Document Name	
Comment	
Likes	0
Dislikes	0
Response	
Kevin Conway - Public Utility District No. 1 of Pend Oreille County - 1,3,5,6	
Answer	Yes
Document Name	
Comment	
Likes	0
Dislikes	0
Response	
Anthony Jablonski - ReliabilityFirst - 10	
Answer	Yes
Document Name	

Comment	
Likes 0	
Dislikes 0	
Response	
Leonard Kula - Independent Electricity System Operator - 2	
Answer	Yes
Document Name	
Comment	
Likes 0	
Dislikes 0	
Response	
Jeanne Kurzynowski - CMS Energy - Consumers Energy Company - 1,3,4,5 - RF	
Answer	Yes
Document Name	
Comment	
Likes 0	
Dislikes 0	
Response	

Bette White - AES - Indianapolis Power and Light Co. - 3	
Answer	Yes
Document Name	
Comment	
Likes 0	
Dislikes 0	
Response	
Michelle Amarantos - APS - Arizona Public Service Co. - 1	
Answer	Yes
Document Name	
Comment	
Likes 0	
Dislikes 0	
Response	
Chris Wagner - Santee Cooper - 1, Group Name Santee Cooper	
Answer	Yes
Document Name	
Comment	

Likes 0	
Dislikes 0	
Response	
Matthew Nutsch - Seattle City Light - 1,3,4,5,6 - WECC	
Answer	Yes
Document Name	
Comment	
Likes 0	
Dislikes 0	
Response	

3. To address Scope Item ‘f’ from the approved SAR, the SDT added an exemption to the Applicability (Facilities) to clarify that all auxiliary equipment and associated protection(s) within the generating Facility are not applicable to the standard. Do you agree with the ‘Exemption’? If not, please provide the basis for your disagreement and an alternate solution.

Rachel Coyne - Texas Reliability Entity, Inc. - 10

Answer No

Document Name

Comment

The language in section 4.2.1.3 appears to conflict with the language in section 4.2.2. Section 4.2.3.1 includes the high side of the generator-connected auxiliary transformer, while section 4.2.2 exempts protection on all auxiliary equipment within the generating Facility. Please clarify why Facilities meeting applicability Section 4.2.1.3 would not fall under this exemption.

Texas RE has the following additional comments:

- The Severe VSL for R4 needs an additional row space between settings and “OR”.
- Page 9 of 23 states: “In Requirements R1, R3, and R4, all references to “Generator Owner” are replaced with “Generator Owner **and** Transmission Owner.”” Texas RE noticed on Page 12 of 23: VSL for D.A.2. says Generator owner “**or**” Transmission Owner. Should it be changed to “**and**” to be consistent with the statement above?

Likes 0

Dislikes 0

Response

Thank you for your comments. Section 4.2.1.3 specifically refers to protection connected to the high side of the UAT. Auxiliary equipment typically is connected on the low side of the UAT.

The space has been added in the severe VSL for R4.

These comments pertain to the Hydro Quebec variance. In that system, there are cases where the main power transformer is not owned by the interconnecting utility. Thus is it possible that a violation could be committed by either the Generator Owner OR the Transmission Owner.

Marty Hostler - Northern California Power Agency - 5

Answer No

Document Name

Comment

See TRE comments.

Likes 0

Dislikes 0

Response

See response to TRE.

Dana Klem - MRO - 1,2,3,4,5,6 - MRO, Group Name MRO NSRF

Answer Yes

Document Name

Comment

Volts/Hertz relaying is specifically included in the applicability section 4.2.1., but is not included in the exemptions listed in Footnote 4. Please include the relay function Volts/Hertz as part of Footnote 4.

Likes 0

Dislikes 0

Response	
Thank you for your comment. The SDT has made this change in the new footnote 6.	
Maryanne Darling-Reich - Black Hills Corporation - 1,3,5,6 - MRO,WECC	
Answer	Yes
Document Name	
Comment	
BHC agrees with EEI's comments as submitted	
Likes	0
Dislikes	0
Response	
See response for EEI's comment.	
Aaron Cavanaugh - Bonneville Power Administration - 1,3,5,6 - WECC	
Answer	Yes
Document Name	
Comment	
None	
Likes	0
Dislikes	0
Response	
Larry Heckert - Alliant Energy Corporation Services, Inc. - 4	

Answer	Yes
Document Name	
Comment	
Support NSRF Comments: Volts/Hertz relaying is specifically included in the applicability section 4.2.1., but is not included in the exemptions listed in Footnote 4. Please include the relay function Volts/Hertz as part of Footnote 4.	
Likes 0	
Dislikes 0	
Response	
Thank you for your comment. The SDT has made this change in the new footnote 6.	
Daniel Gacek - Exelon - 1	
Answer	Yes
Document Name	
Comment	
Exelon appreciates and supports the clearly stated exemption for auxiliary equipment. On behalf of Exelon, Segments 1, 3, 5, 6	
Likes 0	
Dislikes 0	
Response	
Thank you for your comment.	

Wayne Guttormson - SaskPower - 1	
Answer	Yes
Document Name	
Comment	
Support the MRO NSRF comments.	
Likes	0
Dislikes	0
Response	
Please see the response to MRO NSRF.	
Matthew Nutsch - Seattle City Light - 1,3,4,5,6 - WECC	
Answer	Yes
Document Name	
Comment	
Likes	0
Dislikes	0
Response	
Chris Wagner - Santee Cooper - 1, Group Name Santee Cooper	
Answer	Yes
Document Name	
Comment	

Likes 0	
Dislikes 0	
Response	
Michelle Amarantos - APS - Arizona Public Service Co. - 1	
Answer	Yes
Document Name	
Comment	
Likes 0	
Dislikes 0	
Response	
Bette White - AES - Indianapolis Power and Light Co. - 3	
Answer	Yes
Document Name	
Comment	
Likes 0	
Dislikes 0	
Response	

Jeanne Kurzynowski - CMS Energy - Consumers Energy Company - 1,3,4,5 - RF	
Answer	Yes
Document Name	
Comment	
Likes 0	
Dislikes 0	
Response	
Leonard Kula - Independent Electricity System Operator - 2	
Answer	Yes
Document Name	
Comment	
Likes 0	
Dislikes 0	
Response	
Anthony Jablonski - ReliabilityFirst - 10	
Answer	Yes
Document Name	
Comment	

Likes	0
Dislikes	0
Response	
Thomas Foltz - AEP - 5	
Answer	Yes
Document Name	
Comment	
Likes	0
Dislikes	0
Response	
Kevin Conway - Public Utility District No. 1 of Pend Oreille County - 1,3,5,6	
Answer	Yes
Document Name	
Comment	
Likes	0
Dislikes	0
Response	
Bridget Silvia - Sempra - San Diego Gas and Electric - 3	

Answer	Yes
Document Name	
Comment	
Likes 0	
Dislikes 0	
Response	
Dennis Chastain - Tennessee Valley Authority - 1,3,5,6 - SERC	
Answer	Yes
Document Name	
Comment	
Likes 0	
Dislikes 0	
Response	
Mark Garza - FirstEnergy - FirstEnergy Corporation - 4, Group Name FE Voter	
Answer	Yes
Document Name	
Comment	
Likes 0	

Dislikes	0
Response	
Karl Blaszkowski - CMS Energy - Consumers Energy Company - 3	
Answer	Yes
Document Name	
Comment	
Likes	0
Dislikes	0
Response	
Kim Thomas - Duke Energy - 1,3,5,6 - SERC,RF, Group Name Duke Energy	
Answer	Yes
Document Name	
Comment	
Likes	0
Dislikes	0
Response	
Amy Casuscelli - Amy Casuscelli On Behalf of: Carrie Dixon, Xcel Energy, Inc. , 6; Gerry Huitt, Xcel Energy, Inc., 1, 5, 3; - Amy Casuscelli	
Answer	Yes

Document Name	
Comment	
Likes 0	
Dislikes 0	
Response	
Donald Lynd - CMS Energy - Consumers Energy Company - 1	
Answer	Yes
Document Name	
Comment	
Likes 0	
Dislikes 0	
Response	
Davis Jelusich - Public Utility District No. 1 of Chelan County - 6, Group Name Public Utility District No. 1 of Chelan County	
Answer	Yes
Document Name	
Comment	
Likes 0	
Dislikes 0	

Response	
Glen Farmer - Avista - Avista Corporation - 5	
Answer	Yes
Document Name	
Comment	
Likes	0
Dislikes	0
Response	
Neil Swearingen - Salt River Project - 1,3,5,6 - WECC	
Answer	Yes
Document Name	
Comment	
Likes	0
Dislikes	0
Response	
Richard Jackson - U.S. Bureau of Reclamation - 1	
Answer	Yes
Document Name	

Comment	
Likes	0
Dislikes	0
Response	
Siddharth Pant - GE - General Electric Power Systems - NA - Not Applicable - NA - Not Applicable	
Answer	Yes
Document Name	
Comment	
Likes	0
Dislikes	0
Response	
Jamie Monette - Allete - Minnesota Power, Inc. - 1	
Answer	Yes
Document Name	
Comment	
Likes	0
Dislikes	0
Response	

Nick Batty - Keys Energy Services - 9 - SERC	
Answer	Yes
Document Name	
Comment	
Likes 0	
Dislikes 0	
Response	
Sean Bodkin - Dominion - Dominion Resources, Inc. - 6, Group Name Dominion	
Answer	Yes
Document Name	
Comment	
Likes 0	
Dislikes 0	
Response	
Bruce Reimer - Manitoba Hydro - 1	
Answer	Yes
Document Name	
Comment	

Likes 0	
Dislikes 0	
Response	
Glenn Barry - Los Angeles Department of Water and Power - 5	
Answer	Yes
Document Name	
Comment	
Likes 0	
Dislikes 0	
Response	
Ruida Shu - Northeast Power Coordinating Council - 1,2,3,4,5,6,7,8,9,10 - NPCC, Group Name RSC	
Answer	Yes
Document Name	
Comment	
Likes 0	
Dislikes 0	
Response	

Karie Barczak - DTE Energy - Detroit Edison Company - 3, Group Name DTE Energy - DTE Electric	
Answer	Yes
Document Name	
Comment	
Likes 0	
Dislikes 0	
Response	
Mark Gray - Edison Electric Institute - NA - Not Applicable - NA - Not Applicable	
Answer	Yes
Document Name	
Comment	
Likes 0	
Dislikes 0	
Response	
Jodirah Green - ACES Power Marketing - 1,3,4,5,6 - MRO,WECC,Texas RE,SERC,RF, Group Name ACES Standard Collaborations	
Answer	Yes
Document Name	
Comment	

Likes	0
Dislikes	0
Response	
<p>Douglas Webb - Douglas Webb On Behalf of: Allen Klassen, Westar Energy, 6, 3, 1, 5; Bryan Taggart, Westar Energy, 6, 3, 1, 5; Derek Brown, Westar Energy, 6, 3, 1, 5; Grant Wilkerson, Westar Energy, 6, 3, 1, 5; James McBee, Great Plains Energy - Kansas City Power and Light Co., 1, 3, 6, 5; Jennifer Flandermeyer, Great Plains Energy - Kansas City Power and Light Co., 1, 3, 6, 5; John Carlson, Great Plains Energy - Kansas City Power and Light Co., 1, 3, 6, 5; Marcus Moor, Great Plains Energy - Kansas City Power and Light Co., 1, 3, 6, 5; - Douglas Webb, Group Name Westar-KCPL</p>	
Answer	Yes
Document Name	
Comment	
Likes	0
Dislikes	0
Response	
<p>Line Dufour - Hydro-Quebec Production - 6 - NPCC</p>	
Answer	Yes
Document Name	
Comment	
Likes	0
Dislikes	0

Response	
Chantal Mazza - Hydro-Quebec TransEnergie - 2 - NPCC	
Answer	Yes
Document Name	
Comment	
Likes	0
Dislikes	0
Response	
Constantin Chitescu - Ontario Power Generation Inc. - 5	
Answer	Yes
Document Name	
Comment	
Likes	0
Dislikes	0
Response	
Chris Gowder - Florida Municipal Power Agency - 5, Group Name FMPA	
Answer	Yes
Document Name	

Comment	
Likes 0	
Dislikes 0	
Response	
Trevor Tidwell - PNM Resources - Public Service Company of New Mexico - 3	
Answer	Yes
Document Name	
Comment	
Likes 0	
Dislikes 0	
Response	
Pamela Hunter - Southern Company - Southern Company Services, Inc. - 1,3,5,6 - SERC, Group Name Southern Company	
Answer	Yes
Document Name	
Comment	
Likes 0	
Dislikes 0	
Response	

Teresa Cantwell - Lower Colorado River Authority - 5	
Answer	Yes
Document Name	
Comment	
Likes 0	
Dislikes 0	
Response	

4. Based on industry feedback, the SDT replaced the 0.1 second ‘Minimum Time (Sec)’ value in the frequency tables with “Instantaneous” and provided additional clarity via Footnote #6 regarding frequency calculation/measurement. Do you agree with this change? If not, please provide the basis for your disagreement and an alternate solution.

Marty Hostler - Northern California Power Agency - 5

Answer No

Document Name

Comment

It appears it was changed back to what is was originally? We need a Redline showing changes form the last approved standard to the current proposal.

Likes 0

Dislikes 0

Response

Thank you for your comments. A redline to last approved will be posted with final ballot.

Jamie Monette - Allete - Minnesota Power, Inc. - 1

Answer No

Document Name

Comment

Minnesota Power suggests changing the frequency tables and figures to show “Time Delay” rather than “Time.” Then the tables could show 0.0 seconds, or they could go back to what was shown in PRC-024-2 “Instantaneous Trip.”

Minnesota Power suggests altering Footnote 7 to read:

“Frequency is calculated over a window of time. Time delays shown in Attachment 1 Figures 1-4 and Tables 1-4 refer to the minimum required time delay after the frequency calculation has completed.”

The last sentence of the current footnote is confusing (“Instantaneous trip settings based on instantaneously calculated frequency measurement is not permissible.”). If this sentence remains, the standard should clarify the minimum window required rather than just describing a typical window.

Likes 0

Dislikes 0

Response

Thank you for your comment. The SDT believes the frequency tables and figures are appropriately labeled.

The SDT believes the existing footnote adequately addresses the issue of frequency measurement.

Wayne Guttormson - SaskPower - 1

Answer Yes

Document Name

Comment

Support the MRO NSRF comments.

Likes 0

Dislikes 0

Response

See response to MRO NSRF.

Daniel Gacek - Exelon - 1

Answer Yes

Document Name

Comment

Exelon agrees with the change back to “Instantaneous”, however Footnote #7 describes a concern associated with microprocessor protection only and should therefore be limited to microprocessor protection.

Exelon suggests the following language:

7 Microprocessor protection calculates frequency over a window of time. While the frequency boundaries include the option to trip instantaneously for frequencies outside the specified range, microprocessor protection should perform this calculation over a time window. Typical window/filtering lengths are three to six cycles (50 – 100 milliseconds). Instantaneous trip settings by microprocessor protection based on instantaneously calculated frequency measurement is not permissible. Electromechanical and solid-state protection does not exhibit the concern described and may use instantaneous trip settings.

On behalf of Exelon, Segments 1, 3, 5, 6

Likes 0

Dislikes 0

Response

Thank you for your comment. The SDT believes the existing footnote adequately addresses the issue of frequency measurement.

If electromechanical and solid-state protection do not exhibit the concern and do not calculate frequency instantaneously, then they would not be subject to the footnote. The footnote will remain technology-neutral.

Larry Heckert - Alliant Energy Corporation Services, Inc. - 4

Answer

Yes

Document Name

Comment

Support NSRF comments:

Footnote 7 states that instantaneous trip settings based on instantaneously calculated frequency measurement is not permissible. We request an explanation of the technical basis of this footnote and methods to determine whether our trip settings are permissible. It seems that verification will be difficult to achieve without input from relay manufacturers.

Likes 0

Dislikes 0

Response

Thank you for your comment. A finding from Blue Cut Fire Event states, “A significant amount of solar PV resources disconnected due to a perceived system frequency below 57 Hz. This perceived frequency was due to the PLL indicating a near instantaneous frequency during the transient/distorted waveform period as less than 57 Hz.”

Ruida Shu - Northeast Power Coordinating Council - 1,2,3,4,5,6,7,8,9,10 - NPCC, Group Name RSC

Answer

Yes

Document Name

Comment

Please include the NPCC Region’s underfrequency no-trip boundary in the Supplemental Material section of the standard – Attachment 1. The NPCC Region’s under-frequency boundary is more stringent than the Eastern Interconnection Boundary.

The low voltage duration, voltage (pu) < 0.45 minimum (sec) 0.15 appears to be insufficient. Clearing times for High Voltage circuits can often exceed 0.15 seconds. Therefore, the exposure to generators tripping during normally cleared faults is higher than optimal. Please consider increasing the Low Voltage Duration No Trip Zone-boundary for the <0.45 pu voltage threshold.

Please consider adding additional details of restrictions on active and reactive power cessations during underfrequency or overfrequency conditions. As written, the standard could allow momentary cessation of active (real) current inside the frequency envelope of Attachment 1, as long as reactive current is provided. Cessation of active (real) current for frequencies inside the frequency envelope could compromise the effectiveness of the UFLS program.

Likes 0

Dislikes 0

Response	
<p>Thank you for your comment. Inclusion of the NPCC Region’s underfrequency no-trip boundary is not part of Project 2018-04 scope. The team does not have enough technical justification to change the trip curves from the original version and it is not included in Project 2018-04 scope.</p> <p>The current draft is written intentionally to allow for a cease of real or reactive current, but not both simultaneously.</p>	
Bruce Reimer - Manitoba Hydro - 1	
Answer	Yes
Document Name	
Comment	
<p>Shouldn't the graph also reflect this change with the minimum time changed to 0 second?</p>	
Likes	0
Dislikes	0
Response	
<p>Per footnote 6: “The figures do not visually represent the “no trip zone” boundaries before 0.1 seconds and after 10,000 seconds. The Frequency Boundary Data Points Table defines the entirety of the “no trip zone” boundaries”. This is due to the limitations of plotting a figure on a logarithmic scale.</p>	
Rachel Coyne - Texas Reliability Entity, Inc. - 10	
Answer	Yes
Document Name	
Comment	
<p>Texas RE noticed this shows as Footnote 7, not Footnote 6.</p>	
Likes	0

Dislikes	0
Response	
Thank you for your comment. This was a typo in the question.	
Aaron Cavanaugh - Bonneville Power Administration - 1,3,5,6 - WECC	
Answer	Yes
Document Name	
Comment	
None	
Likes	0
Dislikes	0
Response	
Maryanne Darling-Reich - Black Hills Corporation - 1,3,5,6 - MRO,WECC	
Answer	Yes
Document Name	
Comment	
BHC agrees with EEI's comments as submitted	
Likes	0
Dislikes	0
Response	
See response to EEI comments.	

Dana Klem - MRO - 1,2,3,4,5,6 - MRO, Group Name MRO NSRF	
Answer	Yes
Document Name	
Comment	
<p>Footnote 7 states that instantaneous trip settings based on instantaneously calculated frequency measurement is not permissible. We request an explanation of the technical basis of this footnote and methods to determine whether our trip settings are permissible. It seems that verification will be difficult to achieve without input from relay manufacturers.</p> <p>The note, “The area outside the “No Trip Zone” is not a “Must Trip Zone” is not included after the graph on PRC-024 – Attachment 2, Page 21/27 of the redline draft 09202019.</p>	
Likes	0
Dislikes	0
Response	
<p>Thank you for your comment. A finding from Blue Cut Fire Event states: “A significant amount of solar PV resources disconnected due to a perceived system frequency below 57 Hz. This perceived frequency was due to the PLL indicating a near instantaneous frequency during the transient/distorted waveform period as less than 57 Hz.” For relay’s the relay manufacture documentation may provide this verification.</p> <p>The note, “The area outside the “No Trip Zone” is not a “Must Trip Zone” will be included on the final draft after the graph on PRC-024 – Attachment 2.</p>	
Leonard Kula - Independent Electricity System Operator - 2	
Answer	Yes
Document Name	
Comment	

In order to prevent the facility from being tripped for phase to ground faults cleared in breaker failure time, we suggest that the wording “Unless otherwise specified by the Transmission Planner” be added to the Boundary Details #4 in Attachment 2: Voltage Boundary Clarifications – Eastern, Western, and ERCOT Interconnections, as follows:

“ 4. Unless otherwise specified by the Transmission Planner, voltages in boundaries assume RMS fundamental frequency phase-to-phase ground or phase-to-phase unit per unit voltage.”

Likes 0

Dislikes 0

Response

Thank you for the comments, but it’s not clear to the SDT what other voltage boundaries the Transmission Planner would specify.

Teresa Cantwell - Lower Colorado River Authority - 5

Answer

Yes

Document Name

Comment

Likes 0

Dislikes 0

Response

Trevor Tidwell - PNM Resources - Public Service Company of New Mexico - 3

Answer

Yes

Document Name

Comment

Likes	0
Dislikes	0
Response	
Chris Gowder - Florida Municipal Power Agency - 5, Group Name FMPA	
Answer	Yes
Document Name	
Comment	
Likes	0
Dislikes	0
Response	
Constantin Chitescu - Ontario Power Generation Inc. - 5	
Answer	Yes
Document Name	
Comment	
Likes	0
Dislikes	0
Response	
Chantal Mazza - Hydro-Qu?bec TransEnergie - 2 - NPCC	

Answer	Yes
Document Name	
Comment	
Likes 0	
Dislikes 0	
Response	
Line Dufour - Hydro-Quebec Production - 6 - NPCC	
Answer	Yes
Document Name	
Comment	
Likes 0	
Dislikes 0	
Response	
<p>Douglas Webb - Douglas Webb On Behalf of: Allen Klassen, Westar Energy, 6, 3, 1, 5; Bryan Taggart, Westar Energy, 6, 3, 1, 5; Derek Brown, Westar Energy, 6, 3, 1, 5; Grant Wilkerson, Westar Energy, 6, 3, 1, 5; James McBee, Great Plains Energy - Kansas City Power and Light Co., 1, 3, 6, 5; Jennifer Flandermeyer, Great Plains Energy - Kansas City Power and Light Co., 1, 3, 6, 5; John Carlson, Great Plains Energy - Kansas City Power and Light Co., 1, 3, 6, 5; Marcus Moor, Great Plains Energy - Kansas City Power and Light Co., 1, 3, 6, 5; - Douglas Webb, Group Name Westar-KCPL</p>	
Answer	Yes
Document Name	

Comment	
Likes 0	
Dislikes 0	
Response	
Jodirah Green - ACES Power Marketing - 1,3,4,5,6 - MRO,WECC,Texas RE,SERC,RF, Group Name ACES Standard Collaborations	
Answer	Yes
Document Name	
Comment	
Likes 0	
Dislikes 0	
Response	
Mark Gray - Edison Electric Institute - NA - Not Applicable - NA - Not Applicable	
Answer	Yes
Document Name	
Comment	
Likes 0	
Dislikes 0	
Response	

Karie Barczak - DTE Energy - Detroit Edison Company - 3, Group Name DTE Energy - DTE Electric	
Answer	Yes
Document Name	
Comment	
Likes 0	
Dislikes 0	
Response	
Glenn Barry - Los Angeles Department of Water and Power - 5	
Answer	Yes
Document Name	
Comment	
Likes 0	
Dislikes 0	
Response	
Sean Bodkin - Dominion - Dominion Resources, Inc. - 6, Group Name Dominion	
Answer	Yes
Document Name	
Comment	

Likes 0	
Dislikes 0	
Response	
Nick Batty - Keys Energy Services - 9 - SERC	
Answer	Yes
Document Name	
Comment	
Likes 0	
Dislikes 0	
Response	
Michael Goggin - Grid Strategies - 5 - NA - Not Applicable	
Answer	Yes
Document Name	
Comment	
Likes 0	
Dislikes 0	
Response	

Siddharth Pant - GE - General Electric Power Systems - NA - Not Applicable - NA - Not Applicable	
Answer	Yes
Document Name	
Comment	
Likes 0	
Dislikes 0	
Response	
Richard Jackson - U.S. Bureau of Reclamation - 1	
Answer	Yes
Document Name	
Comment	
Likes 0	
Dislikes 0	
Response	
Neil Swearingen - Salt River Project - 1,3,5,6 - WECC	
Answer	Yes
Document Name	
Comment	

Likes	0
Dislikes	0
Response	
Glen Farmer - Avista - Avista Corporation - 5	
Answer	Yes
Document Name	
Comment	
Likes	0
Dislikes	0
Response	
Davis Jelusich - Public Utility District No. 1 of Chelan County - 6, Group Name Public Utility District No. 1 of Chelan County	
Answer	Yes
Document Name	
Comment	
Likes	0
Dislikes	0
Response	
Donald Lynd - CMS Energy - Consumers Energy Company - 1	

Answer	Yes
Document Name	
Comment	
Likes 0	
Dislikes 0	
Response	
Amy Casuscelli - Amy Casuscelli On Behalf of: Carrie Dixon, Xcel Energy, Inc. , 6; Gerry Huitt, Xcel Energy, Inc., 1, 5, 3; - Amy Casuscelli	
Answer	Yes
Document Name	
Comment	
Likes 0	
Dislikes 0	
Response	
Kim Thomas - Duke Energy - 1,3,5,6 - SERC,RF, Group Name Duke Energy	
Answer	Yes
Document Name	
Comment	
Likes 0	

Dislikes	0
Response	
Karl Blaszkowski - CMS Energy - Consumers Energy Company - 3	
Answer	Yes
Document Name	
Comment	
Likes	0
Dislikes	0
Response	
Mark Garza - FirstEnergy - FirstEnergy Corporation - 4, Group Name FE Voter	
Answer	Yes
Document Name	
Comment	
Likes	0
Dislikes	0
Response	
Dennis Chastain - Tennessee Valley Authority - 1,3,5,6 - SERC	
Answer	Yes

Document Name	
Comment	
Likes 0	
Dislikes 0	
Response	
Bridget Silvia - Sempra - San Diego Gas and Electric - 3	
Answer	Yes
Document Name	
Comment	
Likes 0	
Dislikes 0	
Response	
Kevin Conway - Public Utility District No. 1 of Pend Oreille County - 1,3,5,6	
Answer	Yes
Document Name	
Comment	
Likes 0	
Dislikes 0	

Response	
Thomas Foltz - AEP - 5	
Answer	Yes
Document Name	
Comment	
Likes	0
Dislikes	0
Response	
Anthony Jablonski - ReliabilityFirst - 10	
Answer	Yes
Document Name	
Comment	
Likes	0
Dislikes	0
Response	
Jeanne Kurzynowski - CMS Energy - Consumers Energy Company - 1,3,4,5 - RF	
Answer	Yes
Document Name	

Comment	
Likes 0	
Dislikes 0	
Response	
Bette White - AES - Indianapolis Power and Light Co. - 3	
Answer	Yes
Document Name	
Comment	
Likes 0	
Dislikes 0	
Response	
Michelle Amarantos - APS - Arizona Public Service Co. - 1	
Answer	Yes
Document Name	
Comment	
Likes 0	
Dislikes 0	
Response	

Chris Wagner - Santee Cooper - 1, Group Name Santee Cooper	
Answer	Yes
Document Name	
Comment	
Likes 0	
Dislikes 0	
Response	
Matthew Nutsch - Seattle City Light - 1,3,4,5,6 - WECC	
Answer	Yes
Document Name	
Comment	
Likes 0	
Dislikes 0	
Response	

5. Based on industry feedback, the SDT revised the Implementation Plan to provide twenty-four months for applicable entities to evaluate settings, make changes for applicable equipment, and purchase necessary equipment, if necessary. Do you agree with the revised Implementation Plan? If not, please provide the basis for your disagreement and an alternate proposal.

Thomas Foltz - AEP - 5

Answer No

Document Name

Comment

As we similarly stated in the previous comment period, we believe that 24 months is still insufficient, especially in regards to impacts associated with a) changing, albeit unintentionally, the historically recognized “Point of Interconnection” as the reference point of compliance and b) the inclusion of applicable functions on the high side of generator-connected auxiliary transformers. AEP suggests that the proposed implementation plan be increased to 36 months as the proposed changes would redefine the entire scope of the work performed to date.

There are a number of important, non-controversial clarifications being proposed to improve this standard that should not be delayed by the perhaps more controversial and possibly even more time-consuming requirements. For example, the proposed clarifications for Attachments 1 and 2 could and should be implemented as soon as practical, however any revisions affecting the applicability scope or “point of interconnection” should be delayed in their implementation. As a result, we suggest splitting implementation to advance as rapidly as possible these clarifications.

Likes 0

Dislikes 0

Response

Thank you for your comments. The SDT continues to believe 24 months for implementation is sufficient, and the currently enforceable standard also uses the high-side as the point of interconnection. Also, the team believes that assessing any voltage, volts per hz, and frequency applied on the high-side of the UAT should not be burden within the 24 month timeframe.

Dennis Chastain - Tennessee Valley Authority - 1,3,5,6 - SERC

Answer No

Document Name

Comment

As discussed in some detail in the previous round of comments, the 24-month implementation period (though better than the original 18-month one) is still not enough time for some (nuclear, in particular) units to implement the new requirements if they have equipment that has to be modified. Per the typical nuclear projects process, they have to 1) obtain funding for and perform an analysis to see if they have compliance gaps [this can take a year plus, depending on when this version gets approved and where they are in the annual funding cycle] and, if so, 2) obtain funding for the change(s) [possibly another year plus], 3) instigate and award a contract to a design partner to complete the design for the change(s) [9 months to a year], and 4) implement the changes which will likely require an outage that can be as much as two years in the future [the change(s) likely won't be that hard to do, but the projects process requires that designs be complete at least 13 months prior to the beginning of the outage, which adds another year plus]. All together, these timeframes could easily add up to well over four years. The original dates for version 1 (and 2) were phased in over a 5-year period. This same issue was raised for the implementation of PRC-025-2 and its SDT provided 5-years to implement the requirements for any new scope. Please provide a 5-year implementation period to give time to implement any required modifications within the standard projects process.

Likes 0

Dislikes 0

Response

Thank you for your comments. The SDT continues to believe the 24-month implementation is sufficient. Any potential changes based on the revised standard will probably be limited to set point changes.

Mark Garza - FirstEnergy - FirstEnergy Corporation - 4, Group Name FE Voter

Answer No

Document Name	
Comment	
Consider a 60-month phased implementation plan as setting changes require time to account for planning, budgeting and outage coordination.	
Likes 0	
Dislikes 0	
Response	
Thank you for your comment. The SDT continues to believe the 24-month implementation is sufficient. Any potential changes based on the revised standard will probably be limited to set point changes.	
Karie Barczak - DTE Energy - Detroit Edison Company - 3, Group Name DTE Energy - DTE Electric	
Answer	No
Document Name	
Comment	
<i>24 months is not sufficient for nuclear power plants. Please reconsider a 36 or 48 month implementation plan.</i>	
Likes 0	
Dislikes 0	
Response	
Thank you for your comment. The SDT continues to believe the 24-month implementation is sufficient. Any potential changes based on the revised standard will probably be limited to set point changes.	
Marty Hostler - Northern California Power Agency - 5	
Answer	No
Document Name	

Comment

NERC originally provided a five year progressive implementation plan for PRC-024-1 and -2. PRC-023-3's original SAR was for Inverter based resources, then a supplemental SAR was developed include UAT and GSUs protection. All PRC-024 studies now have to be redone and potentially more modifications/additions made. The implementation plan should be 5-years.

Likes 0

Dislikes 0

Response

Thank you for your comments. The SDT continues to believe the 24-month implementation is sufficient. Any potential changes based on the revised standard will probably be limited to set point changes.

Daniel Gacek - Exelon - 1

Answer

No

Document Name

Comment

As discussed in some detail in the previous round of comments, the 24-month implementation period (though better than the original 18-month one) is still not enough time for existing, non-inverter based generating units to perform studies, assess compliance with the new revision to the Standard, and implement any necessary modification

Nuclear units typically operate continuously and therefore modifications are scheduled during refueling outages. Refueling outages take place approximately every two years and the work is scheduled years in advance. From budgeting to execution, the modification process at a nuclear unit can add up to well over four years.

This concern was also communicated to the NERC SDT for PRC-025-2 resulting a 5-year implementation period for scope changes.

The original dates for PRC-024 version 1 (and 2) were phased in over a 5-year period. Please consider the same 5-year implementation period for existing, non-inverter based generating units to perform studies and implement any required modifications within their established projects timeframe.

On behalf of Exelon, Segments 1, 3, 5, 6	
Likes	0
Dislikes	0
Response	
Thank you for your comments. The SDT continues to believe the 24-month implementation is sufficient. Any potential changes based on the revised standard will probably be limited to set point changes.	
Anthony Jablonski - ReliabilityFirst - 10	
Answer	Yes
Document Name	
Comment	
ReliabilityFirst notes that there is currently an ERO-endorsed guidance on PRC-024-2. Can ReliabilityFirst assume this ERO-endorsed guidance will be updated as well whenever PRC-024-3 is approved?	
Likes	0
Dislikes	0
Response	
Thank you for your comments. Any of the pre-authorized entities can submit revised Implementation Guidance.	
Maryanne Darling-Reich - Black Hills Corporation - 1,3,5,6 - MRO,WECC	
Answer	Yes
Document Name	
Comment	
BHC agrees with EEI's comments as submitted	

Likes	0
Dislikes	0
Response	
Please see response to EEI.	
Aaron Cavanaugh - Bonneville Power Administration - 1,3,5,6 - WECC	
Answer	Yes
Document Name	
Comment	
None	
Likes	0
Dislikes	0
Response	
Matthew Nutsch - Seattle City Light - 1,3,4,5,6 - WECC	
Answer	Yes
Document Name	
Comment	
Likes	0
Dislikes	0
Response	

Chris Wagner - Santee Cooper - 1, Group Name Santee Cooper	
Answer	Yes
Document Name	
Comment	
Likes 0	
Dislikes 0	
Response	
Michelle Amarantos - APS - Arizona Public Service Co. - 1	
Answer	Yes
Document Name	
Comment	
Likes 0	
Dislikes 0	
Response	
Bette White - AES - Indianapolis Power and Light Co. - 3	
Answer	Yes
Document Name	
Comment	

Likes	0
Dislikes	0
Response	
Jeanne Kurzynowski - CMS Energy - Consumers Energy Company - 1,3,4,5 - RF	
Answer	Yes
Document Name	
Comment	
Likes	0
Dislikes	0
Response	
Kevin Conway - Public Utility District No. 1 of Pend Oreille County - 1,3,5,6	
Answer	Yes
Document Name	
Comment	
Likes	0
Dislikes	0
Response	
Bridget Silvia - Sempra - San Diego Gas and Electric - 3	

Answer	Yes
Document Name	
Comment	
Likes 0	
Dislikes 0	
Response	
Dana Klem - MRO - 1,2,3,4,5,6 - MRO, Group Name MRO NSRF	
Answer	Yes
Document Name	
Comment	
Likes 0	
Dislikes 0	
Response	
Karl Blaszkowski - CMS Energy - Consumers Energy Company - 3	
Answer	Yes
Document Name	
Comment	
Likes 0	

Dislikes	0
Response	
Kim Thomas - Duke Energy - 1,3,5,6 - SERC,RF, Group Name Duke Energy	
Answer	Yes
Document Name	
Comment	
Likes	0
Dislikes	0
Response	
Amy Casuscelli - Amy Casuscelli On Behalf of: Carrie Dixon, Xcel Energy, Inc. , 6; Gerry Huitt, Xcel Energy, Inc., 1, 5, 3; - Amy Casuscelli	
Answer	Yes
Document Name	
Comment	
Likes	0
Dislikes	0
Response	
Donald Lynd - CMS Energy - Consumers Energy Company - 1	
Answer	Yes

Document Name	
Comment	
Likes 0	
Dislikes 0	
Response	
Davis Jelusich - Public Utility District No. 1 of Chelan County - 6, Group Name Public Utility District No. 1 of Chelan County	
Answer	Yes
Document Name	
Comment	
Likes 0	
Dislikes 0	
Response	
Glen Farmer - Avista - Avista Corporation - 5	
Answer	Yes
Document Name	
Comment	
Likes 0	
Dislikes 0	

Response	
Neil Swearingen - Salt River Project - 1,3,5,6 - WECC	
Answer	Yes
Document Name	
Comment	
Likes	0
Dislikes	0
Response	
Richard Jackson - U.S. Bureau of Reclamation - 1	
Answer	Yes
Document Name	
Comment	
Likes	0
Dislikes	0
Response	
Siddharth Pant - GE - General Electric Power Systems - NA - Not Applicable - NA - Not Applicable	
Answer	Yes
Document Name	

Comment	
Likes	0
Dislikes	0
Response	
Jamie Monette - Allete - Minnesota Power, Inc. - 1	
Answer	Yes
Document Name	
Comment	
Likes	0
Dislikes	0
Response	
Rachel Coyne - Texas Reliability Entity, Inc. - 10	
Answer	Yes
Document Name	
Comment	
Likes	0
Dislikes	0
Response	

Nick Batty - Keys Energy Services - 9 - SERC	
Answer	Yes
Document Name	
Comment	
Likes 0	
Dislikes 0	
Response	
Sean Bodkin - Dominion - Dominion Resources, Inc. - 6, Group Name Dominion	
Answer	Yes
Document Name	
Comment	
Likes 0	
Dislikes 0	
Response	
Bruce Reimer - Manitoba Hydro - 1	
Answer	Yes
Document Name	
Comment	

Likes 0	
Dislikes 0	
Response	
Glenn Barry - Los Angeles Department of Water and Power - 5	
Answer	Yes
Document Name	
Comment	
Likes 0	
Dislikes 0	
Response	
Ruida Shu - Northeast Power Coordinating Council - 1,2,3,4,5,6,7,8,9,10 - NPCC, Group Name RSC	
Answer	Yes
Document Name	
Comment	
Likes 0	
Dislikes 0	
Response	

Mark Gray - Edison Electric Institute - NA - Not Applicable - NA - Not Applicable	
Answer	Yes
Document Name	
Comment	
Likes 0	
Dislikes 0	
Response	
Jodirah Green - ACES Power Marketing - 1,3,4,5,6 - MRO,WECC,Texas RE,SERC,RF, Group Name ACES Standard Collaborations	
Answer	Yes
Document Name	
Comment	
Likes 0	
Dislikes 0	
Response	
Douglas Webb - Douglas Webb On Behalf of: Allen Klassen, Westar Energy, 6, 3, 1, 5; Bryan Taggart, Westar Energy, 6, 3, 1, 5; Derek Brown, Westar Energy, 6, 3, 1, 5; Grant Wilkerson, Westar Energy, 6, 3, 1, 5; James McBee, Great Plains Energy - Kansas City Power and Light Co., 1, 3, 6, 5; Jennifer Flandermeyer, Great Plains Energy - Kansas City Power and Light Co., 1, 3, 6, 5; John Carlson, Great Plains Energy - Kansas City Power and Light Co., 1, 3, 6, 5; Marcus Moor, Great Plains Energy - Kansas City Power and Light Co., 1, 3, 6, 5; - Douglas Webb, Group Name Westar-KCPL	
Answer	Yes

Document Name	
Comment	
Likes 0	
Dislikes 0	
Response	
Larry Heckert - Alliant Energy Corporation Services, Inc. - 4	
Answer	Yes
Document Name	
Comment	
Likes 0	
Dislikes 0	
Response	
Line Dufour - Hydro-Quebec Production - 6 - NPCC	
Answer	Yes
Document Name	
Comment	
Likes 0	
Dislikes 0	

Response	
Chantal Mazza - Hydro-Quebec TransEnergie - 2 - NPCC	
Answer	Yes
Document Name	
Comment	
Likes	0
Dislikes	0
Response	
Constantin Chitescu - Ontario Power Generation Inc. - 5	
Answer	Yes
Document Name	
Comment	
Likes	0
Dislikes	0
Response	
Chris Gowder - Florida Municipal Power Agency - 5, Group Name FMPA	
Answer	Yes
Document Name	

Comment	
Likes 0	
Dislikes 0	
Response	
Trevor Tidwell - PNM Resources - Public Service Company of New Mexico - 3	
Answer	Yes
Document Name	
Comment	
Likes 0	
Dislikes 0	
Response	
Pamela Hunter - Southern Company - Southern Company Services, Inc. - 1,3,5,6 - SERC, Group Name Southern Company	
Answer	Yes
Document Name	
Comment	
Likes 0	
Dislikes 0	
Response	

Teresa Cantwell - Lower Colorado River Authority - 5	
Answer	Yes
Document Name	
Comment	
Likes 0	
Dislikes 0	
Response	
Wayne Guttormson - SaskPower - 1	
Answer	Yes
Document Name	
Comment	
Likes 0	
Dislikes 0	
Response	

6. Do you agree that the proposed modifications provide a cost-effective means of addressing issues identified in the SAR? If not, please provide an alternative, more cost-effective manner in which to achieve at least an equivalent level of reliability.

Marty Hostler - Northern California Power Agency - 5

Answer No

Document Name

Comment

More studies and work have to be done. We really need a Standards process that is standard and thoughtfully implemented. It appears Standard modifications are coming out to quickly and causing inefficiencies in redoing work already done. (Standards efficiency project topic?)

NERC should provide a redline showing the difference between the new proposed standard and the existing standard first.

NERC should provide a list detailing studies GO's already did, versus what needs to be redone to comply with the proposed standard.

AND provide an honest cost estimate of redoing studies.

Likes 0

Dislikes 0

Response

Thank you for your feedback. While this is outside of the standard drafting team's scope of duties, NERC staff will share this concern with NERC standards leadership and staff leading the Standards Efficiency Review team.

A redline to last approved will be posted with final ballot.

To comply with the new PRC-024-3, the SDT believes that there is not a significant amount of rework of studies required. The SDT believes as few changes to the standard as needed were made while filling reliability gaps.

Sean Bodkin - Dominion - Dominion Resources, Inc. - 6, Group Name Dominion	
Answer	No
Document Name	
Comment	
<p>Since the comment form does not provide for 'other' or 'additional' comments related to the proposed PRC-024 changes, Dominion Energy is submitting the following comments under this section: 1) Additional clarity around whether the boundary for voltage ride through is part of the no-trip zone or not. This is unclear on the curves and different Regions have interpreted this differently. 2) The revised standard and guidance documents do not address issues, specifically the reflection process, outlined in the NERC Inverter Based Resource Performance Guide that blurs 1.0 per unit inverter voltage (based on inverter rated voltage) and 2) POI voltage in per unit, and appears to equate them. If this is the intent then it should be clearly stated in the revised standard or associated guidance documents. Dominion Energy recommends it be clearly stated that in lieu of reflection voltage, GOs should be allowed to use inverter rated voltage as being equivalent to POI voltage; or allow inverter skid settings to ride the line due to the fact that simulation results illustrate inverter schemes are completely restrained for system POI voltages along the LVRT boundary in PRC-024 Attachment 2.</p>	
Likes 1	Northern California Power Agency, 5, Hostler Marty
Dislikes 0	
Response	
<p>Thank you for your comment. The SDT believes the table “Voltage Boundary Data Points” in Attachment 2 indicate if the lines are inclusive or not in the graph. The SDT believes that the “Evaluate Protection Settings” Section clearly indicates the voltage values in the Attachment 2 voltage boundaries are voltages at the high side of the GSU/MPT. When evaluating protection settings, consider the voltage differences between where the protection is measuring voltage and the high side of the GSU/MPT.</p>	
Rachel Coyne - Texas Reliability Entity, Inc. - 10	
Answer	No
Document Name	
Comment	

Texas RE does not have comments on this question.	
Likes	0
Dislikes	0
Response	
Thank you for your response.	
Siddharth Pant - GE - General Electric Power Systems - NA - Not Applicable - NA - Not Applicable	
Answer	No
Document Name	
Comment	
<p>All the items below can be addressed by clarifications or corrections. They are a possible cause for confusion as stated in the current draft.</p> <p>ITEM 1:</p> <p>PRC-024-2 note 3 in Attachment 2 clarified that the times in the voltage/time curves were cumulative. The SAR had asked for clarifications with respect to start/stop/reset times while leaving cumulative in the verbiage. With the removal of “cumulative” from the voltage/time curves in the draft, there is room for mis-interpretation of the requirements, unless some interpretation guidance is also included. Is it a voltage vs. time profile as given in other grid codes? In other words, does it represent the “worst case” voltage as would be observed on an oscilloscope? Or, should it be interpreted some other way?</p> <p>As an example, for an rms voltage with the following profile (very extreme, but just to make a point):</p> <ul style="list-style-type: none"> a. $t < 0, V = 1$ b. $0 \leq t < 0.1 \text{ sec}, V = 0$ c. $0.1 \text{ sec} \leq t < 1 \text{ sec}, V = 1$ 	

- d. $1 \text{ sec} \leq t < 1.06 \text{ sec}, V = 0$
- e. $1.06 \text{ sec} \leq t \leq 4 \text{ sec}, V = 1$

With “cumulative” in the description, the above curve would be interpreted as falling outside of the “No Trip Zone” of PRC-024-2 as the total time when the voltage is below 0.45 pu is 0.16 sec. What would be the interpretation in the draft PRC-024?

To carry this to an even more extreme, if the voltage was essentially toggling between 1 and 0 every 0.1 sec, that would clearly be outside the “No Trip Zone” of PRC-024-2. How should it be interpreted in the current draft?

ITEM 2:

Attachment 2 - The voltage ride-through figure includes ERCOT in the caption. However, the voltage profile in the ERCOT Nodal Operating Guide Section 2 is different from that in the draft PRC-024 (the HV portion in both curves is the same, the LV portion is different). Is this based on knowledge that ERCOT will be changing their voltage curves to those shown in PRC-024? If not, ERCOT should be treated as a Regional Variance like that done for the Quebec Interconnection. Again, if the release of PRC-024-3 and ERCOT updates are not coordinated, there will be a lack of clarity and possible errors in setting.

ITEM 3:

B.R2 – Under certain conditions of large power production and large voltage dips, to protect itself from destructive overcurrents, an inverter may have to stop producing current for up to 20 ms at the start of the voltage dip. It will then very rapidly ramp back to the current reference values in up to an additional 50 ms. Note this reduction in current is only for a maximum time of 70 ms and not for the duration of the voltage dip. Is such a self-protective fast recovery period of low current considered “cease injecting current”? Will it require documentation under R3?

Note also that this is different from an inverter ceasing to inject current for the duration of the voltage dip and then ramping current after voltage recovery over a 500 ms to 1 second period.

ITEM 4:

In some cases, the clean copy of the draft is different from the redlined version.

Page 7 of clean draft -

Violation Severity Level Tables

R1 - In the Severe VSL cell, the redline document uses terminology “cease injecting current”, the clean document uses terminology “enter momentary cessation”.

R2 - In the Severe VSL cell, the redline document uses terminology “cease injecting current”, the clean document uses terminology “enter momentary cessation”.

Page 11 of clean draft

D.A.2 - In the Severe VSL cell, the redline document uses terminology “cease injecting current”, then clean document uses terminology “enter momentary cessation”.

Likes	0
-------	---

Dislikes	0
----------	---

Response

Thank you for your comments.

Item 1: It is up to each generator owner to understand how their protection would respond to the voltage profile contained on Attachment 2. The SDT believes that different protection schemes may need to incorporate a cumulative approach to accurately model how their protection will respond to the voltage profile in Attachment 2.

Item 2: The team is aware of these differences however the ERCOT Nodal Operating Guide Section 2 is accomplishing a different task than PRC-024-3.

Item 3: As written, PRC-024-3 would require invoking R3 if it is necessary to cease injecting current in the no trip zone for machine protection.

Item 4: These have been corrected in the current redline and clean version of the standard.

Donald Lynd - CMS Energy - Consumers Energy Company - 1

Answer	No
--------	----

Document Name	
---------------	--

Comment

I did not notice any comments in the SAR addressing a need to change the section “Evaluating Protective Relay Settings” in Attachment 2. In this section the drafting team has removed the option of using the assumptions that the units are at full nameplate real-power output and the power factor is 0.95 lagging. I assume that anyone who previously completed their evaluations using these assumptions would need to reevaluate using the most probable real and reactive loading conditions. This could be a significant expense, particularly for those who contracted the original work and would effectively be starting over. Allowing use of the previous assumptions should provide a similar level of reliability without the added cost.

On a related note, item ‘a’ in this section provides instruction regarding the unit under study, but there is no longer clear instruction for the loading of other units connected to the same transformer.

Also related to cost, our existing documentation for wind turbines provides a ride-through curve, but does not indicate when the unit will cease to inject current. For example, one manufacturer’s documentation lists a ride-through time at zero percent voltage with a footnote that the converter may stop pulsing during this period. We have attempted to obtain information from one of our manufacturers in support of another NERC PRC Standard, without success to this point. For existing equipment, there is no guarantee the information necessary to comply with the proposed Standard can be obtained.

Likes	0
Dislikes	0

Response

Thank you for your comments. The SAR directed the SDT to consider whether to address matters to reinforce that the requirements pertain to point of interconnection. That is the reason for the changes to the “Evaluate Protection Relay Settings” section. The SDT believes that by using the most probably real and reactive loading condition, the wording better reflects the reliability intent of the standard. The SDT also believes the example listed above should be addressed through Compliance Guidance.

Karl Blaszkowski - CMS Energy - Consumers Energy Company - 3

Answer	No
Document Name	

Comment

: I did not notice any comments in the SAR addressing a need to change the section “Evaluating Protective Relay Settings” in Attachment 2. In this section the drafting team has removed the option of using the assumptions that the units are at full nameplate real-power output and the power factor is 0.95 lagging. I assume that anyone who previously completed their evaluations using these assumptions would need to reevaluate using the most probable real and reactive loading conditions. This could be a significant expense, particularly for those who contracted the original work and would effectively be starting over. Allowing use of the previous assumptions should provide a similar level of reliability without the added cost.

On a related note, item ‘a’ in this section provides instruction regarding the unit under study, but there is no longer clear instruction for the loading of other units connected to the same transformer.

Also related to cost, our existing documentation for wind turbines provides a ride-through curve, but does not indicate when the unit will cease to inject current. For example, one manufacturer’s documentation lists a ride-through time at zero percent voltage with a footnote that the converter may stop pulsing during this period. We have attempted to obtain information from one of our manufacturers in support of another NERC PRC Standard, without success to this point. For existing equipment, there is no guarantee the information necessary to comply with the proposed Standard can be obtained.

Likes 0

Dislikes 0

Response

Thank you for your comments. The SAR directed the SDT to consider whether to address matters to reinforce that the requirements pertain to point of interconnection. That is the reason for the changes to the “Evaluate Protection Relay Settings” section. The SDT believes that by using the most probably real and reactive loading condition, the wording better reflects the reliability intent of the standard. The SDT also believes the example listed above should be addressed through Compliance Guidance.

Bridget Silvia - Sempra - San Diego Gas and Electric - 3

Answer

No

Document Name

Comment

Do not have enough information to determine if this will be cost-effective or not.	
Likes	0
Dislikes	0
Response	
Thank you for your response.	
Thomas Foltz - AEP - 5	
Answer	No
Document Name	
Comment	
<p>Because the current comment form provides no area for providing general feedback, or feedback regarding areas beyond those stated within the questions themselves, we have elected to provide such feedback in the response to this question.</p> <p>AEP does not agree that the proposed modifications provide a cost-effective means of addressing issues in the SAR. AEP continues to recommend removing the reference to “high-side of generator step-up or collector transformer” and allow Generator Owners to utilize the point of interconnection as defined within the FERC filed Interconnection Service Agreement. AEP believes the SDT should take the opportunity to remain consistent with the currently enforceable versions of PRC-024 and FAC-008 and retain the reference to “point of interconnection” but remove the “clarifying text” which we believe instead describes a point of measurement. The definition as presented creates undue compliance burden on the Generator Owner and may negatively impact ride-through capability for renewable resources with generator interconnection facilities of considerable distance. Driven by these concerns, AEP has chosen to vote negative on the proposed draft.</p> <p>While the currently posted “redline to last posted” document is indeed helpful for seeing the most recently proposed changes, we believe that it should be accompanied by an additional redlined document showing all currently proposed edits-to-date, both additions and deletions, using only the current version subject to enforcement as a baseline (i.e. “redline to last approved”). If only the most recently proposed revisions are shown, incorrect conclusions may be drawn by industry during their review. For example, in the “redline to last posted” document, text in black could be currently included in the version under enforcement or it could instead be text that was</p>	

proposed in the previous draft but left unchanged in the latest draft. Similarly, text shown as deleted could be text recently proposed for deletion in the most recent draft, or instead could be text that was proposed for inclusion in the previous draft but then later struck in the latest draft.

Likes 1	Northern California Power Agency, 5, Hostler Marty
---------	--

Dislikes 0	
------------	--

Response

Thank you for your comments. The currently enforceable standard does use the high-side of the transformer, and the language is consistent with the language in PRC-024-2 footnote 3. A redline to last approved will be posted with final ballot.

Jeanne Kurzynowski - CMS Energy - Consumers Energy Company - 1,3,4,5 - RF

Answer	No
--------	----

Document Name	
---------------	--

Comment

I did not notice any comments in the SAR addressing a need to change the section “Evaluating Protective Relay Settings” in Attachment 2. In this section the drafting team has removed the option of using the assumptions that the units are at full nameplate real-power output and the power factor is 0.95 lagging. I assume that anyone who previously completed their evaluations using these assumptions would need to reevaluate using the most probable real and reactive loading conditions. This could be a significant expense, particularly for those who contracted the original work and would effectively be starting over. Allowing use of the previous assumptions should provide a similar level of reliability without the added cost.

On a related note, item ‘a’ in this section provides instruction regarding the unit under study, but there is no longer clear instruction for the loading of other units connected to the same transformer.

Also related to cost, our existing documentation for wind turbines provides a ride-through curve, but does not indicate when the unit will cease to inject current. For example, one manufacturer’s documentation lists a ride-through time at zero percent voltage with a footnote that the converter may stop pulsing during this period. We have attempted to obtain information from one of our manufacturers in

support of another NERC PRC Standard, without success to this point. For existing equipment, there is no guarantee the information necessary to comply with the proposed Standard can be obtained.

Likes 0

Dislikes 0

Response

Thank you for your comments. The SAR directed the SDT to consider whether to address matters to reinforce that the requirements pertain to point of interconnection. That is the reason for the changes to the “Evaluate Protection Relay Settings” section. The SDT believes that by using the most probably real and reactive loading condition, the wording better reflects the reliability intent of the standard. The SDT also believes the example listed above should be addressed through Compliance Guidance.

Pamela Hunter - Southern Company - Southern Company Services, Inc. - 1,3,5,6 - SERC, Group Name Southern Company

Answer

Yes

Document Name

Comment

If the existing protection equipment (other than discrete protective relays) are incapable of being set to comply with R1 and/or R2, they should not be required to be changed out and should be permitted to be included in the R3 exclusion option, which has been retained in the current draft.

Two other comments regarding the draft and the negative vote explanation:

First item: Changing the title of the standard implies that the scope of included F and V protection settings has been expanded to non-Generator protection items, e.g. mechanical (turbine), et. al. which used electrical signals in the detection/operation. Disagree with this expansion – no documented need for this change w.r.t. system reliability.

Second item: A.) Many generator owners, including this one, have already made inverter controls setting adjustments for inverter-based systems to permit ride-through capability with immediate or minimal delay to restart as a result of the recent NERC Alert recommendations on the subject.

B.) Industry standard P2800 is being written to ensure that future inverter-based electric generating equipment is built with these operational characteristics maximized for grid performance.

C.) A recent CAISO tariff amendment which targets mitigating reliability issues caused by inverter-based generators response to grid disturbances related to high voltage transmission system faults or transient voltage excursions. These changes to the tariff will provide the necessary changes to future inverter-based resources. These tariff revisions result from the CAISO’s most recent Interconnection Process Enhancements “IPE” stakeholder initiative. The Inverter-based resource task force, too, has issued recommended interconnect agreement suggestions for all transmission service providers to consider when agreeing to connect these types of resources to the grid.

The combination of each of these three factors (A, B, and C above) coupled with the absence of system control instability in the current state makes a sufficient case that these changes to PRC-024 are not needed at this time.

Likes 0

Dislikes 0

Response

Thank you for your comments. The current footnotes in the standard address this situation and additional clarity was provided on excluded equipment. The SDT revisions to the title are not intended to expand the standard, and the team’s edits were within the scope of the SC-approved SAR. The applicability section of the standard does not bring in turbine protections. For the second item, the SDT made the necessary changes as required by the SAR.

Line Dufour - Hydro-Quebec Production - 6 - NPCC

Answer Yes

Document Name

Comment

We have an additional comment about the draft RSAW that is shown on the project page. It doesn’t include the two requirements D.A.2 and D.A.5 from the variance for the Quebec Interconnection.

Likes 0

Dislikes 0

Response	
Thank you. We can provide the feedback to Compliance.	
Jodirah Green - ACES Power Marketing - 1,3,4,5,6 - MRO,WECC,Texas RE,SERC,RF, Group Name ACES Standard Collaborations	
Answer	Yes
Document Name	
Comment	
The new and revised language proposed for PRC-024-3 provide a cost-effective means of addressing the most pressing industry concerns expressed in comments to the SAR. ACES appreciates the efforts of NERC and the drafting team, and the opportunity to comment.	
Likes	0
Dislikes	0
Response	
Thank you for your comment.	
Aaron Cavanaugh - Bonneville Power Administration - 1,3,5,6 - WECC	
Answer	Yes
Document Name	
Comment	
None	
Likes	0
Dislikes	0
Response	

Amy Casuscelli - Amy Casuscelli On Behalf of: Carrie Dixon, Xcel Energy, Inc. , 6; Gerry Huitt, Xcel Energy, Inc., 1, 5, 3; - Amy Casuscelli

Answer	Yes
---------------	-----

Document Name	
----------------------	--

Comment

Xcel Energy is supportive of the modifications prosed. We also submit the following reword of Footnote 4 to assist in readability: "Excludes limitations caused by the setting capability of the frequency and voltage protective relays for the generating resource(s). *This* does not exclude limitations originating in the equipment protected by the relays or frequency and voltage protection that is embedded in control systems."

Likes 0	
---------	--

Dislikes 0	
------------	--

Response

Thank you for your comments. The SDT had edited the footnote for clarity.

Wayne Guttormson - SaskPower - 1

Answer	Yes
---------------	-----

Document Name	
----------------------	--

Comment

Likes 0	
---------	--

Dislikes 0	
------------	--

Response

Teresa Cantwell - Lower Colorado River Authority - 5

Answer	Yes
---------------	-----

Document Name	
Comment	
Likes 0	
Dislikes 0	
Response	
Trevor Tidwell - PNM Resources - Public Service Company of New Mexico - 3	
Answer	Yes
Document Name	
Comment	
Likes 0	
Dislikes 0	
Response	
Daniel Gacek - Exelon - 1	
Answer	Yes
Document Name	
Comment	
Likes 0	
Dislikes 0	

Response	
Constantin Chitescu - Ontario Power Generation Inc. - 5	
Answer	Yes
Document Name	
Comment	
Likes	0
Dislikes	0
Response	
Chantal Mazza - Hydro-Qu?bec TransEnergie - 2 - NPCC	
Answer	Yes
Document Name	
Comment	
Likes	0
Dislikes	0
Response	
Larry Heckert - Alliant Energy Corporation Services, Inc. - 4	
Answer	Yes
Document Name	

Comment	
Likes	0
Dislikes	0
Response	
Karie Barczak - DTE Energy - Detroit Edison Company - 3, Group Name DTE Energy - DTE Electric	
Answer	Yes
Document Name	
Comment	
Likes	0
Dislikes	0
Response	
Ruida Shu - Northeast Power Coordinating Council - 1,2,3,4,5,6,7,8,9,10 - NPCC, Group Name RSC	
Answer	Yes
Document Name	
Comment	
Likes	0
Dislikes	0
Response	

Glenn Barry - Los Angeles Department of Water and Power - 5	
Answer	Yes
Document Name	
Comment	
Likes 0	
Dislikes 0	
Response	
Bruce Reimer - Manitoba Hydro - 1	
Answer	Yes
Document Name	
Comment	
Likes 0	
Dislikes 0	
Response	
Nick Batty - Keys Energy Services - 9 - SERC	
Answer	Yes
Document Name	
Comment	

Likes 0	
Dislikes 0	
Response	
Jamie Monette - Allele - Minnesota Power, Inc. - 1	
Answer	Yes
Document Name	
Comment	
Likes 0	
Dislikes 0	
Response	
Michael Goggin - Grid Strategies - 5 - NA - Not Applicable	
Answer	Yes
Document Name	
Comment	
Likes 0	
Dislikes 0	
Response	

Richard Jackson - U.S. Bureau of Reclamation - 1	
Answer	Yes
Document Name	
Comment	
Likes 0	
Dislikes 0	
Response	
Neil Swearingen - Salt River Project - 1,3,5,6 - WECC	
Answer	Yes
Document Name	
Comment	
Likes 0	
Dislikes 0	
Response	
Glen Farmer - Avista - Avista Corporation - 5	
Answer	Yes
Document Name	
Comment	

Likes	0
Dislikes	0
Response	
Davis Jelusich - Public Utility District No. 1 of Chelan County - 6, Group Name Public Utility District No. 1 of Chelan County	
Answer	Yes
Document Name	
Comment	
Likes	0
Dislikes	0
Response	
Maryanne Darling-Reich - Black Hills Corporation - 1,3,5,6 - MRO,WECC	
Answer	Yes
Document Name	
Comment	
Likes	0
Dislikes	0
Response	
Kim Thomas - Duke Energy - 1,3,5,6 - SERC,RF, Group Name Duke Energy	

Answer	Yes
Document Name	
Comment	
Likes 0	
Dislikes 0	
Response	
Mark Garza - FirstEnergy - FirstEnergy Corporation - 4, Group Name FE Voter	
Answer	Yes
Document Name	
Comment	
Likes 0	
Dislikes 0	
Response	
Dana Klem - MRO - 1,2,3,4,5,6 - MRO, Group Name MRO NSRF	
Answer	Yes
Document Name	
Comment	
Likes 0	

Dislikes 0	
Response	
Kevin Conway - Public Utility District No. 1 of Pend Oreille County - 1,3,5,6	
Answer	Yes
Document Name	
Comment	
Likes 0	
Dislikes 0	
Response	
Anthony Jablonski - ReliabilityFirst - 10	
Answer	Yes
Document Name	
Comment	
Likes 0	
Dislikes 0	
Response	
Bette White - AES - Indianapolis Power and Light Co. - 3	
Answer	Yes

Document Name	
Comment	
Likes 0	
Dislikes 0	
Response	
Michelle Amaranos - APS - Arizona Public Service Co. - 1	
Answer	Yes
Document Name	
Comment	
Likes 0	
Dislikes 0	
Response	
Chris Wagner - Santee Cooper - 1, Group Name Santee Cooper	
Answer	Yes
Document Name	
Comment	
Likes 0	
Dislikes 0	

Response	
Matthew Nutsch - Seattle City Light - 1,3,4,5,6 - WECC	
Answer	Yes
Document Name	
Comment	
Likes	0
Dislikes	0
Response	
Jonathan Robbins - Seminole Electric Cooperative, Inc. - 1,3,4,5,6	
Answer	
Document Name	PRC-024-2 - PRC-024-3 (Draft 2) Comments and Questions.docx
Comment	
See additional questions/comments attached.	
Likes	0
Dislikes	0
Response	
Thank you for your comment.	
Item 1: The table specifies whether or not the boundary lines are inclusive or exclusive.	
Item 2: The SDT notes that the table specifies the requirements before 0.1 seconds.	

Item 3: The table specifies whether or not the boundary lines are inclusive or exclusive.	
Item 4: The SDT notes that the minimum time is 4.00 seconds, meaning a setting at 4.00 seconds for voltages outside of the no trip zone would be acceptable.	
Douglas Webb - Douglas Webb On Behalf of: Allen Klassen, Westar Energy, 6, 3, 1, 5; Bryan Taggart, Westar Energy, 6, 3, 1, 5; Derek Brown, Westar Energy, 6, 3, 1, 5; Grant Wilkerson, Westar Energy, 6, 3, 1, 5; James McBee, Great Plains Energy - Kansas City Power and Light Co., 1, 3, 6, 5; Jennifer Flandermeyer, Great Plains Energy - Kansas City Power and Light Co., 1, 3, 6, 5; John Carlson, Great Plains Energy - Kansas City Power and Light Co., 1, 3, 6, 5; Marcus Moor, Great Plains Energy - Kansas City Power and Light Co., 1, 3, 6, 5; - Douglas Webb, Group Name Westar-KCPL	
Answer	
Document Name	
Comment	
Westar Energy and Kansas City Power & Light support the Edison Electric Institutes (EEI) Comments	
Likes	0
Dislikes	0
Response	
Please see response to EEI.	

End of Report

Standard Development Timeline

This section is maintained by the drafting team during the development of the standard and will be removed when the standard is adopted by the NERC Board of Trustees (Board).

Description of Current Draft

PRC-024-3 is posted for a 10-day final ballot.

Completed Actions	Date
Standards Committee approved Standard Authorization Request (SAR) for posting	December 2018
SAR posted for comment	December 2018 – January 2019
Standards Committee accepted the revised SAR	February 2019
45-day formal comment period with ballot	April – May 2019
45-day formal or informal comment period with additional ballot	September – November 2019

Anticipated Actions	Date
10-day final ballot	December 2019
Board adoption	February 2020

A. Introduction

1. **Title:** **Frequency and Voltage Protection Settings** for Generating Resources
2. **Number:** PRC-024-3
3. **Purpose:** To set protection such that generating resource(s) remain connected during defined frequency and voltage excursions in support of the Bulk Electric System (BES).
4. **Applicability:**
 - 4.1. **Functional Entities:**
 - 4.1.1 Generator Owners that apply protection listed in Section 4.2.1.
 - 4.1.2 Transmission Owners (in the Quebec Interconnection only) that own a BES generator step-up (GSU) transformer or main power transformer (MPT)¹ and apply protection listed in Section 4.2.1.
 - 4.1.3 Planning Coordinators (in the Quebec Interconnection only)
 - 4.2. **Facilities²:**
 - 4.2.1 Frequency, voltage, and volts per hertz protection (whether provided by relaying or functions within associated control systems) that respond to electrical signals and: (i) directly trip the generating resource(s); or (ii) provide signals to the generating resource(s) to either trip or cease injecting current; and are applied to the following:
 - 4.2.1.1 BES generating resource(s).
 - 4.2.1.2 BES GSU transformer(s).
 - 4.2.1.3 High side of the generator-connected unit auxiliary transformer³ (UAT) installed on BES generating resource(s).
 - 4.2.1.4 Individual dispersed power producing resource(s) identified in the BES Definition, Inclusion I4.
 - 4.2.1.5 Elements that are designed primarily for the delivery of capacity from the individual dispersed power producing resources

¹ For the purpose of this standard, the MPT is the power transformer that steps up voltage from the collection system voltage to the nominal transmission/interconnecting system voltage for dispersed power producing resources.

² It is not required to install or activate the protections described in Facilities Section 4.2.

³ These transformers are variably referred to as station power UAT, or station service transformer(s) used to provide overall auxiliary power to the generating resource(s). This UAT is the transformer connected on the generator bus between the low side of the GSU and the generator terminal.

identified in the BES Definition, Inclusion I4, to the point where those resources aggregate to greater than 75 MVA.

4.2.1.6 MPT⁴ of resource(s) identified in the BES Definition, Inclusion I4.

4.2.2 Exemptions: Protection on all auxiliary equipment within the generating Facility.

5. Effective Date: See the Implementation Plan for PRC-024-3.

⁴ For the purpose of this standard, the MPT is the power transformer that steps up voltage from the collection system voltage to the nominal transmission/interconnecting system voltage for dispersed power producing resources

B. Requirements and Measures

- R1.** Each Generator Owner shall set its applicable frequency protection⁵ in accordance with PRC-024 Attachment 1 such that the applicable protection does not cause the generating resource to trip or cease injecting current within the “no trip zone” during a frequency excursion with the following exceptions: *[Violation Risk Factor: Medium]*
[Time Horizon: Long-term Planning]
- Applicable frequency protection may be set to trip or cease injecting current within a portion of the “no trip zone” for documented and communicated regulatory or equipment limitations in accordance with Requirement R3.
- M1.** Each Generator Owner shall have evidence that the applicable frequency protection has been set in accordance with Requirement R1, such as dated setting sheets, calibration sheets, calculations, or other documentation.
- R2.** Each Generator Owner shall set its applicable voltage protection⁵ in accordance with PRC-024 Attachment 2, such that the applicable protection does not cause the generating resource to trip or cease injecting current within the “no trip zone” during a voltage excursion at the high side of the GSU or MPT, subject to the following exceptions: *[Violation Risk Factor: Medium]* *[Time Horizon: Long-term Planning]*
- If the Transmission Planner allows less stringent voltage protection settings than those required to meet PRC-024 Attachment 2, then the Generator Owner may set its protection within the voltage recovery characteristics of a location-specific Transmission Planner’s study.
 - Applicable voltage protection may be set to trip or cease injecting current during a voltage excursion within a portion of the “no trip zone” for documented and communicated regulatory or equipment limitations in accordance with Requirement R3.
- M2.** Each Generator Owner shall have evidence that applicable voltage protection has been set in accordance with Requirement R2, such as dated setting sheets, voltage-time boundaries, calibration sheets, coordination plots, dynamic simulation studies, calculations, or other documentation.

⁵ Frequency, voltage, and volts per hertz protection (whether provided by relaying or functions within associated control systems) that respond to electrical signals and: (i) directly trip the generating resource(s); or (ii) provide signals to the generating resource(s) to either trip or cease injecting current.

- R3.** Each Generator Owner shall document each known regulatory or equipment limitation⁶ that prevents an applicable generating resource(s) with frequency or voltage protection from meeting the protection setting criteria in Requirements R1 or R2, including (but not limited to) study results, experience from an actual event, or manufacturer’s advice.
[Violation Risk Factor: Lower] [Time Horizon: Long-term Planning]
- 3.1.** The Generator Owner shall communicate the documented regulatory or equipment limitation, or the removal of a previously documented regulatory or equipment limitation, to its Planning Coordinator and Transmission Planner within 30 calendar days of any of the following:
- Identification of a regulatory or equipment limitation.
 - Repair of the equipment causing the limitation that removes the limitation.
 - Replacement of the equipment causing the limitation with equipment that removes the limitation.
 - Creation or adjustment of an equipment limitation caused by consumption of the cumulative turbine life-time frequency excursion allowance.
- M3.** Each Generator Owner shall have evidence that it has documented and communicated any known regulatory or equipment limitations that resulted in an exception to Requirements R1 or R2 in accordance with Requirement R3, such as a dated email or letter that contains such documentation as study results, experience from an actual event, or manufacturer’s advice.
- R4.** Each Generator Owner shall provide its applicable protection settings associated with Requirements R1 and R2 to the Planning Coordinator or Transmission Planner that models the associated generating resource(s) within 60 calendar days of receipt of a written request for the data and within 60 calendar days of any change to those previously requested settings unless directed by the requesting Planning Coordinator or Transmission Planner that the reporting of protection setting changes is not required.
[Violation Risk Factor: Lower] [Time Horizon: Operations Planning]
- M4.** Each Generator Owner shall have evidence that it communicated applicable protection settings in accordance with Requirement R4, such as dated e-mails, correspondence or other evidence and copies of any requests it has received for that information.

⁶ Excludes limitations caused by the setting capability of the frequency, voltage, and volts per hertz protective relays for the generating resource(s). This does not exclude limitations originating in the equipment protected by the relay. This also does not exclude limitations of frequency, voltage, and volts per hertz protection embedded in control systems.

C. Compliance

1. Compliance Monitoring Process

1.1. Compliance Enforcement Authority: “Compliance Enforcement Authority” means NERC or the Regional Entity, or any entity as otherwise designated by an Applicable Governmental Authority, in their respective roles of monitoring and/or enforcing compliance with mandatory and enforceable Reliability Standards in their respective jurisdictions.

1.2. Evidence Retention: The following evidence retention period(s) identify the period of time an entity is required to retain specific evidence to demonstrate compliance. For instances where the evidence retention period specified below is shorter than the time since the last audit, the Compliance Enforcement Authority may ask an entity to provide other evidence to show that it was compliant for the full-time period since the last audit.

The applicable entity shall keep data or evidence to show compliance as identified below unless directed by its Compliance Enforcement Authority to retain specific evidence for a longer period of time as part of an investigation.

- The Generator Owner shall keep data or evidence Requirement R1 through R4; for 3 years or until the next audit, whichever is longer.
- If a Generator Owner is found non-compliant, the Generator Owner or Transmission Owner shall keep information related to the non-compliance until mitigation is complete and approved for the time period specified above, whichever is longer.

1.3. Compliance Monitoring and Assessment Program: As defined in the NERC Rules of Procedure, “Compliance Monitoring and Enforcement Program” refers to the identification of the processes that will be used to evaluate data or information for the purpose of assessing performance or outcomes with the associated Reliability Standard.

Violation Severity Levels

R #	Violation Severity Levels			
	Lower VSL	Moderate VSL	High VSL	Severe VSL
R1.	N/A	N/A	N/A	The Generator Owner failed to set its applicable frequency protection so that it does not trip or cease injecting current according to Requirement R1.
R2.	N/A	N/A	N/A	The Generator Owner failed to set its applicable voltage protection so that it does not trip or cease injecting current according to Requirement R2.
R3.	The Generator Owner documented the known non-protection system equipment limitation that prevented it from meeting the criteria in Requirement R1 or R2 and communicated the documented limitation to its Planning Coordinator and Transmission Planner more than 30 calendar days but less than or equal to 60 calendar	The Generator Owner documented the known non-protection system equipment limitation that prevented it from meeting the criteria in Requirement R1 or R2 and communicated the documented limitation to its Planning Coordinator and Transmission Planner more than 60 calendar	The Generator Owner documented the known non-protection system equipment limitation that prevented it from meeting the criteria in Requirement R1 or R2 and communicated the documented limitation to its Planning Coordinator and Transmission Planner	The Generator Owner failed to document any known non-protection system equipment limitation that prevented it from meeting the criteria in Requirement R1 or R2. OR The Generator Owner failed to communicate the

R #	Violation Severity Levels			
	Lower VSL	Moderate VSL	High VSL	Severe VSL
	days of identifying the limitation.	days but less than or equal to 90 calendar days of identifying the limitation.	more than 90 calendar days but less than or equal to 120 calendar days of identifying the limitation.	documented limitation to its Planning Coordinator and Transmission Planner within 120 calendar days of identifying the limitation.
R4.	<p>The Generator Owner provided its protection settings more than 60 calendar days but less than or equal to 90 calendar days of any change to those settings.</p> <p>OR</p> <p>The Generator Owner provided protection settings more than 60 calendar days but less than or equal to 90 calendar days of a written request.</p>	<p>The Generator Owner provided its protection settings more than 90 calendar days but less than or equal to 120 calendar days of any change to those settings.</p> <p>OR</p> <p>The Generator Owner provided protection settings more than 90 calendar days but less than or equal to 120 calendar days of a written request.</p>	<p>The Generator Owner provided its protection settings more than 120 calendar days but less than or equal to 150 calendar days of any change to those settings.</p> <p>OR</p> <p>The Generator Owner provided protection settings more than 120 calendar days but less than or equal to 150 calendar days of a written request.</p>	<p>The Generator Owner failed to provide its protection settings within 150 calendar days of any change to those settings.</p> <p>OR</p> <p>The Generator Owner failed to provide protection settings within 150 calendar days of a written request.</p>

D. Regional Variances

D.A. Variance for the Quebec Interconnection

This Variance extends the applicability of Requirements R1, R3, and R4 to Transmission Owners in the Quebec Interconnection that own a BES GSU or MPT and apply protection listed in Section 4.2.1, Facilities. This Variance also replaces Requirement R2 of the continent-wide standard in its entirety and adds a new requirement, Requirement D.A.5., applicable to Planning Coordinators in the Quebec Interconnection.

In Requirements R1, R3, and R4, all references to “Generator Owner” are replaced with “Generator Owner and Transmission Owner.”

This Variance replaces continent-wide Requirement R2 in its entirety with the following:

D.A.2. Each Generator Owner and Transmission Owner shall set its applicable voltage protection⁵ in accordance with PRC-024 Attachment 2a, such that the applicable protection does not cause the generating resource to trip or cease injecting current during a voltage excursion within the “no trip zone” at the high side of the GSU or MPT, subject to the following exceptions: *[Violation Risk Factor: Medium] [Time Horizon: Long-term Planning]*

- For newly designated strategic power plants, applicable protections must comply with the high voltage durations for such plants within 48 calendar months of the notification made pursuant to Requirement D.A.5. During this transition period, voltage protections must at least comply with the high voltage durations for “all power plants”.
- The generating resource(s) are permitted to be set to trip or to cease injecting current during a voltage excursion bounded by the “no trip zone” of PRC-024 Attachment 2a for documented and communicated regulatory or equipment limitations in accordance with Requirement R3.
- If the Transmission Planner allows less stringent voltage protection settings than those required to meet PRC-024 Attachment 2a, then the Generator Owner or Transmission Owner may set its protection within the voltage recovery characteristics of a location-specific Transmission Planner’s study.
- Inverter-based resources voltage protection settings may be set to cease injecting current momentarily during a voltage excursion at the high side of the MPT, bounded by the “no trip zone” of PRC-024 Attachment 2a, under the following conditions:

- After a minimum delay of 0.022 s, when the positive-sequence voltage exceeds 1.25 per unit (p.u.) Normal operation must resume once the voltage drops back below 1.25 p.u at the high side of the MPT.
- After a minimum delay of 0.022 s, when the phase-to-ground root mean square (RMS) voltages exceeds 1.4 p.u., as measured at generator terminals, on one or multiple phases. Normal operation must resume once the positive-sequence voltage drops back below the 1.25 p.u. at the high side of the MPT.

M.D.A.2. Each Generator Owner and Transmission Owner shall have evidence that applicable voltage protection has been set in accordance with Requirement R2, such as dated setting sheets, voltage-time boundaries, calibration sheets, coordination plots, dynamic simulation studies, calculations, or other documentation.

This Variance adds the following Requirement:

- D.A.5** Each Planning Coordinator shall designate, at least once every five calendar years, the strategic power plants that must comply with Attachment 2a and notify, within 30 calendar days of its designation, each Generator Owner or Transmission Owner that owns facilities⁷ in the strategic power plants. [*Violation Risk Factor: Medium*] [*Time Horizon: Long-term planning*]
- M.D.A.5** Each Planning Coordinator shall have evidence that it designated, at least once every five calendar years, strategic power plants in accordance with Requirement D.A.5, Part 5 and shall have dated evidence that each Generator Owner or Transmission Owner has been notified in accordance with Requirement D.A.5, part 5.2. Evidence may include, but is not limited to: letters, emails, electronic files, or hard copy records demonstrating transmittal of information.

⁷ Facilities in the strategic power plants include facilities from the generator up to and including the MPT or GSU.

Violation Severity Levels

This Variance adds a VSL for D.A.5 and modifies the VSL for R2 as follows:

R #	Violation Severity Levels			
	Lower VSL	Moderate VSL	High VSL	Severe VSL
D.A.2.	N/A	N/A	N/A	<p>The Generator Owner or Transmission Owner failed to set its applicable voltage protection so that it does not trip or cease injecting current in accordance with Requirement D.A.2.</p> <p>OR</p> <p>The Generator Owner or Transmission Owner set its applicable voltage protection in accordance with Requirement D.A.2 but, for strategic power plants, failed to do so within 48 months of notification.</p>
D.A.5.	N/A	The Planning Coordinator designated strategic power plants at least once every five calendar years but notified each Generator Owner or Transmission Owner that owns	The Planning Coordinator designated strategic power plants at least once every five calendar years but notified each Generator Owner or Transmission Owner that owns	The Planning Coordinator failed to designate, at least once every five years, the strategic power plants that must comply with Attachment 2a.

R #	Violation Severity Levels			
	Lower VSL	Moderate VSL	High VSL	Severe VSL
		facilities in the strategic power plants between 31 days and 45 days after its designation.	facilities in the strategic power plants between 46 days and 60 days after its designation.	OR The Planning Coordinator failed to notify, each Generator Owner or Transmission Owner that owns facilities in the strategic power plants or notified them more than 60 days after the its designation.

E. Associated Documents

Implementation Plan

Version History

Version	Date	Action	Change Tracking
1	May 9, 2013	Adopted by the NERC Board of Trustees	
1	March 20, 2014	FERC Order issued approving PRC-024-1. (Order becomes effective on 7/1/16.)	
2	February 12, 2015	Adopted by the NERC Board of Trustees	Standard revised in Project 2014-01: Applicability revised to clarify application of requirements to BES dispersed power producing resources
2	May 29, 2015	FERC Letter Order in Docket No. RD15-3-000 approving PRC-024-2	Modifications to adjust the applicability to owners of dispersed generation resources.
3	TBD	Adopted by the NERC Board of Trustees	Standard revised in Project 2018-04

Attachment 1 (Frequency No Trip Boundaries by Interconnection⁸)

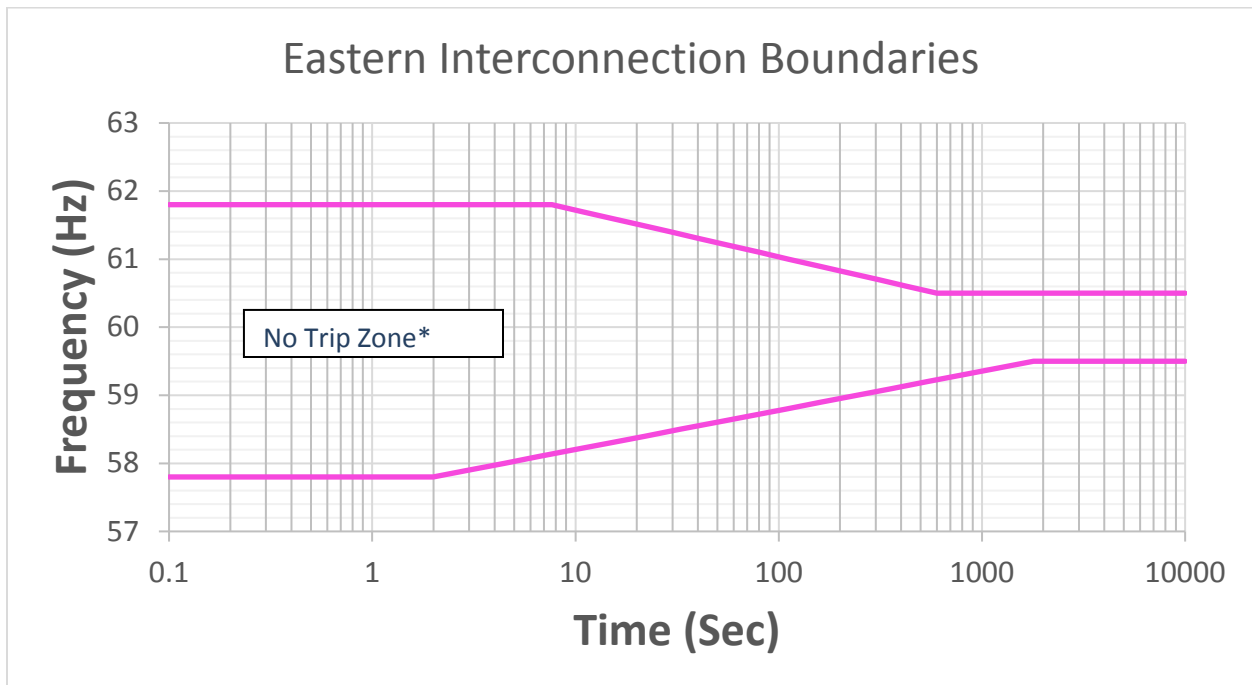

Figure 1

** The area outside the "No Trip Zone" is not a "Must Trip Zone."*

Frequency Boundary Data Points - Eastern Interconnection

High Frequency Duration		Low Frequency Duration	
Frequency (Hz)	Minimum Time (Sec)	Frequency (Hz)	Minimum Time (sec)
≥61.8	Instantaneous ⁹	≤57.8	Instantaneous ⁹
≥60.5	$10^{(90.935-1.45713*f)}$	≤59.5	$10^{(1.7373*f-100.116)}$
<60.5	Continuous operation	> 59.5	Continuous operation

Table 1

⁸ The figures do not visually represent the “no trip zone” boundaries before 0.1 seconds and after 10,000 seconds. The Frequency Boundary Data Points Table defines the entirety of the “no trip zone” boundaries.

⁹ Frequency is calculated over a window of time. While the frequency boundaries include the option to trip instantaneously for frequencies outside the specified range, this calculation should occur over a time window. Typical window/filtering lengths are three to six cycles (50 – 100 milliseconds). Instantaneous trip settings based on instantaneously calculated frequency measurement is not permissible.

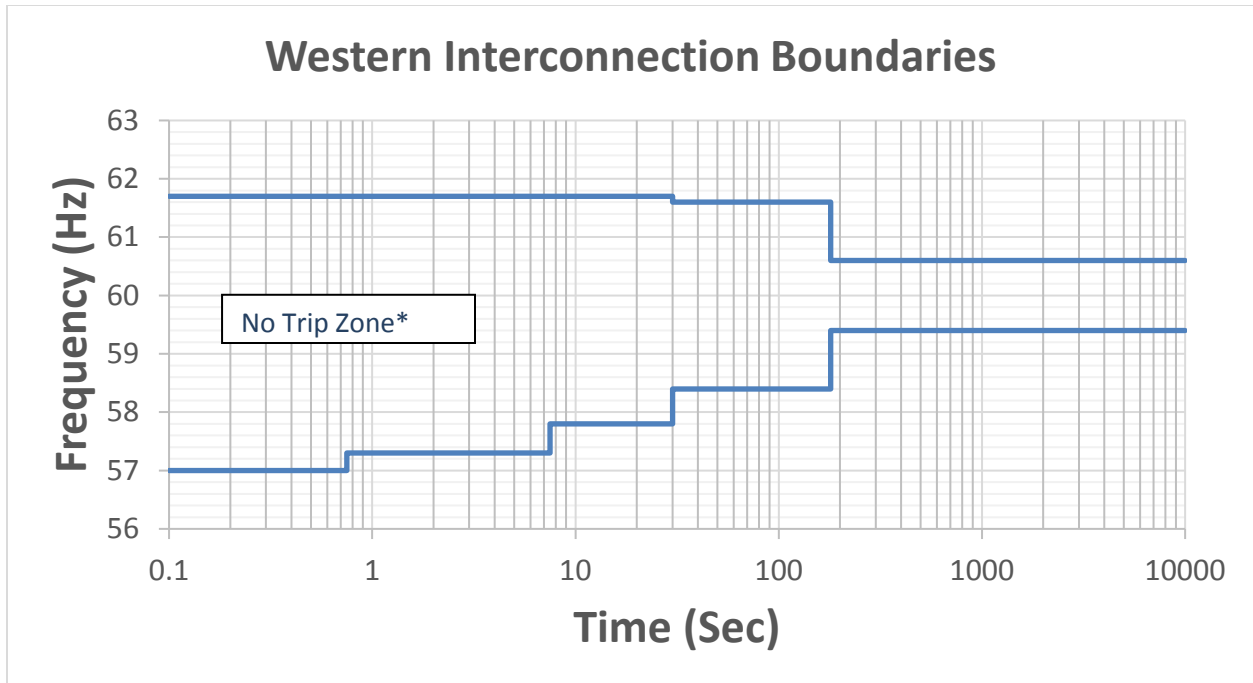

Figure 2

* The area outside the "No Trip Zone" is not a "Must Trip Zone."

Frequency Boundary Data Points –Western Interconnection

High Frequency Duration		Low Frequency Duration	
Frequency (Hz)	Minimum Time (Sec)	Frequency (Hz)	Minimum Time (sec)
≥61.7	Instantaneous ⁹	≤57.0	Instantaneous ⁹
≥61.6	30	≤57.3	0.75
≥60.6	180	≤57.8	7.5
<60.6	Continuous operation	≤58.4	30
		≤59.4	180
		>59.4	Continuous operation

Table 2

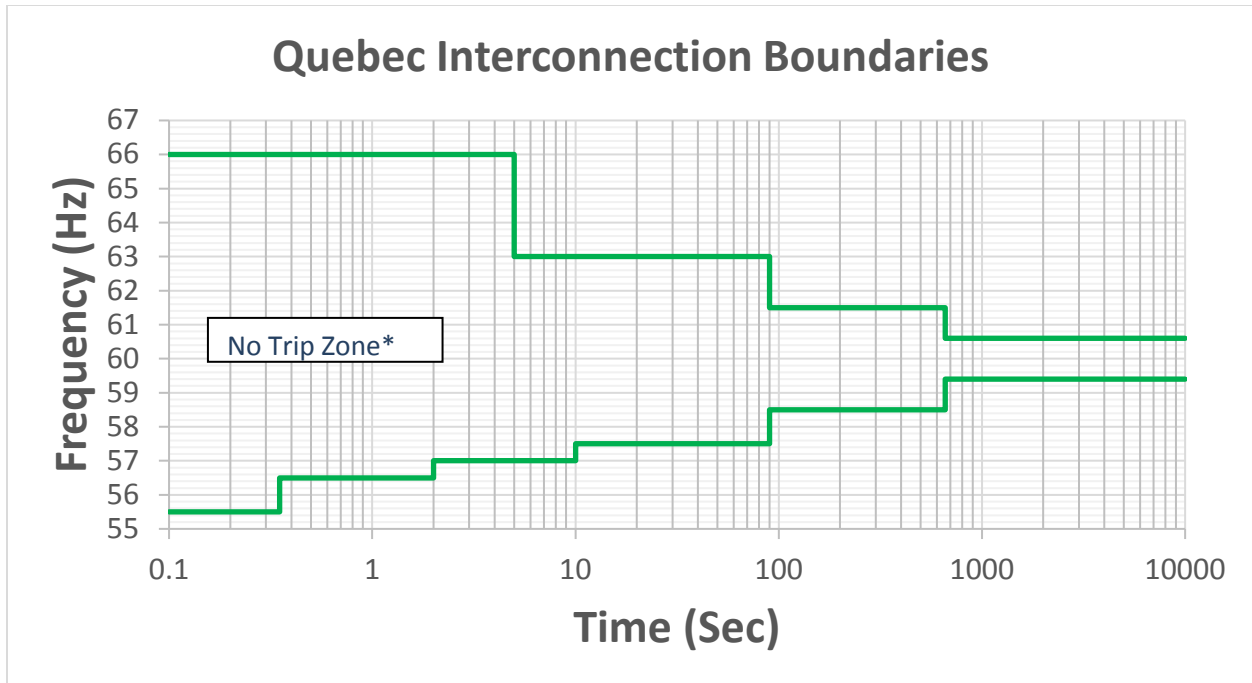

Figure 3

* The area outside the "No Trip Zone" is not a "Must Trip Zone."

Frequency Boundary Data Points – Quebec Interconnection

High Frequency Duration		Low Frequency Duration	
Frequency (Hz)	Minimum Time (Sec)	Frequency (Hz)	Minimum Time (Sec)
>66.0	Instantaneous ⁹	<55.5	Instantaneous ⁹
≥63.0	5	≤56.5	0.35
≥61.5	90	≤57.0	2
≥60.6	660	≤57.5	10
<60.6	Continuous operation	≤58.5	90
		≤59.4	660
		>59.4	Continuous operation

Table 3

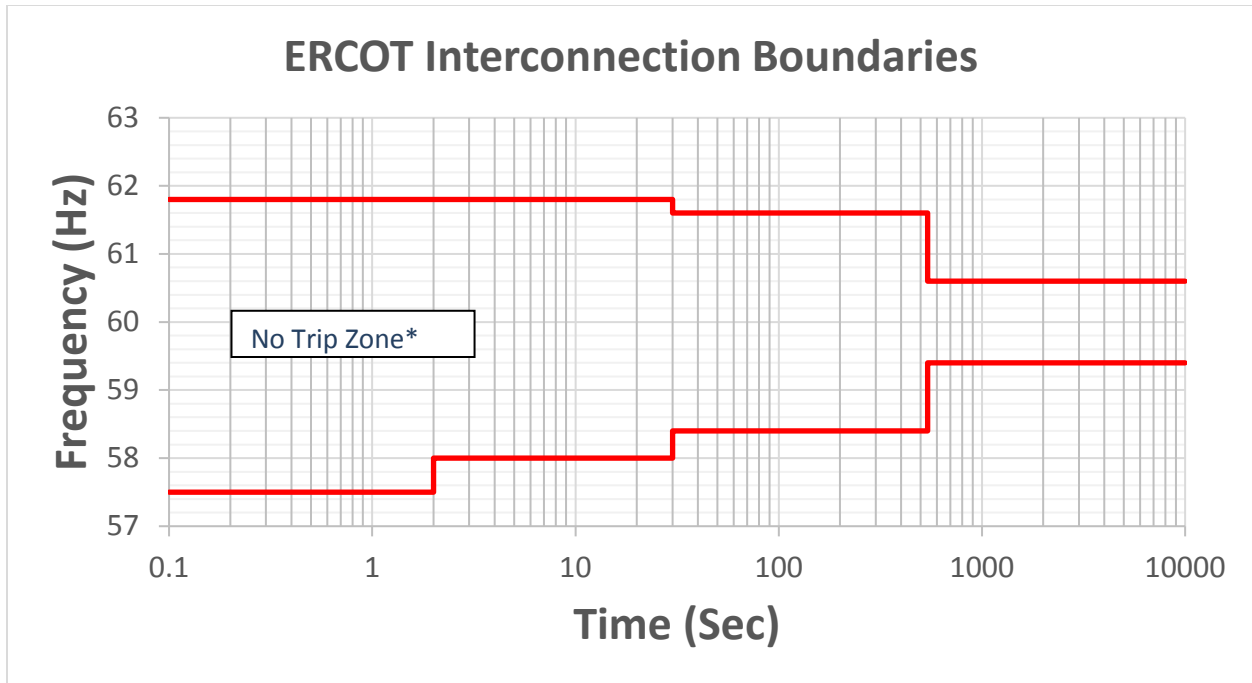

Figure 4

* The area outside the "No Trip Zone" is not a "Must Trip Zone."

Frequency Boundary Data Points – ERCOT Interconnection

High Frequency Duration		Low Frequency Duration	
Frequency (Hz)	Minimum Time (Sec)	Frequency (Hz)	Minimum Time (sec)
≥61.8	Instantaneous ⁹	≤57.5	Instantaneous ⁹
≥61.6	30	≤58.0	2
≥60.6	540	≤58.4	30
<60.6	Continuous operation	≤59.4	540
		>59.4	Continuous operation

Table 4

PRC-024 — Attachment 2

(Voltage No-Trip Boundaries – Eastern, Western, and ERCOT Interconnections)

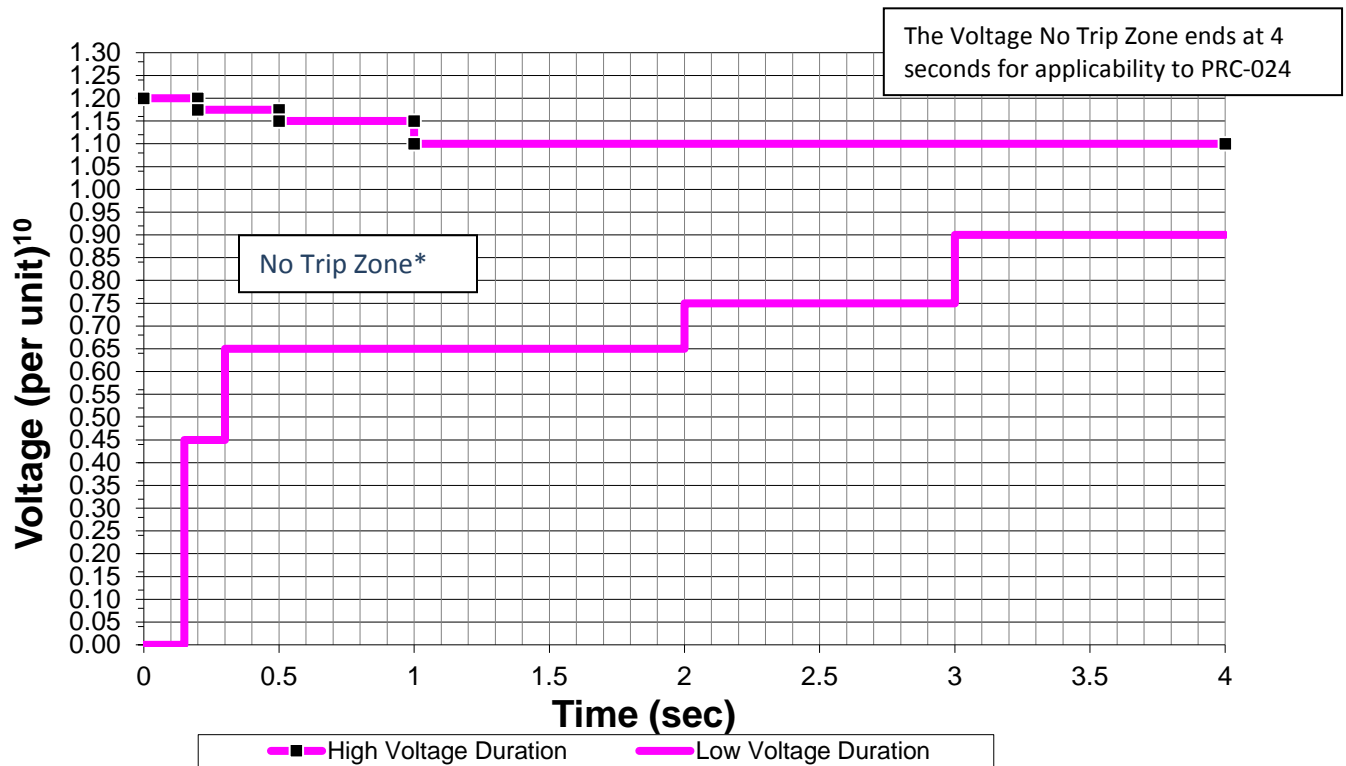

Figure 1

** The area outside the "No Trip Zone" is not a "Must Trip Zone."*

Voltage Boundary Data Points

High Voltage Duration		Low Voltage Duration	
Voltage (pu)	Minimum Time (sec)	Voltage (pu)	Minimum Time (sec)
≥1.200	0.00	<0.45	0.15
≥1.175	0.20	<0.65	0.30
≥1.15	0.50	<0.75	2.00
≥1.10	1.00	<0.90	3.00
<1.10	4.00	≥ 0.90	4.00

Table 1

¹⁰Voltage at the high-side of the GSU or MPT.

Attachment 2: Voltage Boundary Clarifications – Eastern, Western, and ERCOT Interconnections

Boundary Details:

1. Unless otherwise specified by the Transmission Planner, the per unit voltage base for these boundaries is the nominal transmission system voltage (e.g., 100 kV, 115 kV, 138 kV, 161 kV, 230 kV, 345 kV, 400 kV, 500 kV, 765 kV, etc.).
2. The values in the table represent the minimum time durations allowed for specified voltage excursion thresholds.
3. When evaluating volts per hertz protection, either assume a system frequency of 60 Hertz or the magnitude of the high voltage boundary can be adjusted in proportion to deviations of frequency below 60 Hertz.
4. Voltages in the boundaries assume RMS fundamental frequency phase-to-ground or phase-to-phase per unit voltage.
5. For applicability to PRC-024, the “no trip zone” ends at 4 seconds.

Evaluating Protection Settings:

The voltage values in the Attachment 2 voltage boundaries are voltages at the high side of the GSU/MPT. For generating resources with multiple stages of step up to reach interconnecting voltage, this is the high side of the transformer with a low side below 100kV and a high side 100kV or above. When evaluating protection settings, consider the voltage differences between where the protection is measuring voltage and the high side of the GSU/MPT. A steady state calculation or dynamic simulation may be used.

If using a steady state calculation or dynamic simulation, use the following conditions when evaluating protection settings:

- a. The most probable real and reactive loading conditions for the unit under study.
- b. All installed generating plant reactive support (e.g., static VAR compensators, synchronous condensers, capacitors) equipment is available and operating normally.
- c. Account for the actual tap settings of transformers between the generator terminals and the high side of the GSU/MPT.
- d. For dynamic simulations, the automatic voltage regulator is in automatic voltage control mode with associated limiters in service.

PRC-024— Attachment 2a (Voltage No-Trip Boundaries – Quebec Interconnection)

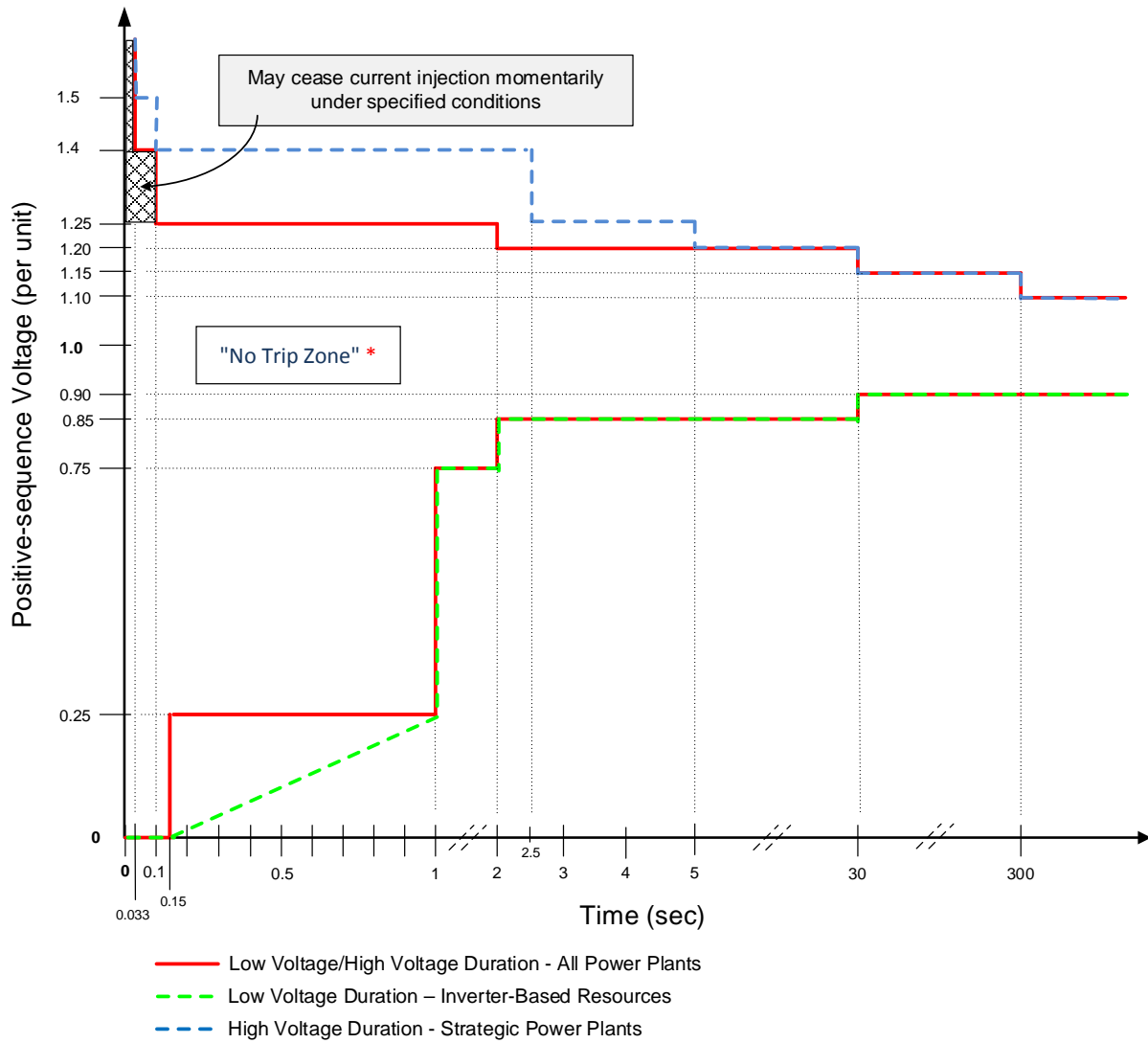

Figure 1

*** The area outside the "No Trip Zone" is not a "Must Trip Zone."**

Voltage Boundary Data Points – Quebec Interconnection

High Voltage Duration for all Power Plants		High Voltage Duration for strategic Power Plants	
Voltage (pu)	Minimum Time (sec)	Voltage (pu)	Minimum Time (sec)
---	---	>1.50	0.033
>1.40	0.033	>1.40	0.10
>1.25	0.10	>1.25	2.50
>1.20	2.00	>1.20	5.00
>1.15	30	>1.15	30
>1.10	300	>1.10	300
≤1.10	continuous	≤1.10	continuous

Table 1

Voltage Boundary Data Points – Quebec Interconnection

Low Voltage Duration for all Power Plants		Low Voltage Duration for Inverter-Based Resources	
Voltage (pu)	Minimum Time (sec)	Voltage (pu)	Minimum Time (sec)
<0.25	0.15	<0.25	$3.4 * V(\text{pu}) + 0.15$
<0.75	1.00	<0.75	1.00
<0.85	2.00	<0.85	2.00
<0.90	30	<0.90	30
≥0.90	continuous	≥0.90	continuous

Table 2

Attachment 2a: Voltage Boundary Clarifications – Quebec Interconnection

Boundary Details:

1. The per unit voltage base for these boundaries is the nominal operating voltage (e.g., 120 kV, 161 kV, 230 kV, 315 kV, 735 kV, etc.).
2. The values in the table represent the minimum time durations allowed for specified voltage excursion thresholds.
3. When evaluating volts per hertz protection, either assume a system frequency of 60 Hertz or the magnitude of the high voltage boundary can be adjusted in proportion to deviations of frequency below 60 Hertz.
4. Voltages in the Quebec Interconnection boundaries assume positive-sequence values.

Evaluating Protection Settings:

The voltage values in the Attachment 2a voltage boundaries are voltages at the high side of the GSU/MPT. For generating resources with multiple stages of step up to reach interconnecting voltage, this is the high side of the transformer that connects to the interconnecting voltage. When evaluating protection settings, consider the voltage differences between where the protection is measuring voltage and the high side of the GSU/MPT. A steady state calculation or dynamic simulation may be used.

If using a steady state calculation or dynamic simulation, use the following conditions when evaluating protection settings:

- a. The most probable real and reactive loading conditions for the unit under study.
- b. All installed generating plant reactive support (e.g., static VAR compensators, synchronous condensers, capacitors) equipment is available and operating normally.
- c. Account for the actual tap settings of transformers between the generator terminals and the high side of the GSU/MPT.
- d. For dynamic simulations, the automatic voltage regulator is in automatic voltage control mode with associated limiters in service.

Standard Development Timeline

This section is maintained by the drafting team during the development of the standard and will be removed when the standard is adopted by the NERC Board of Trustees (Board).

Description of Current Draft

PRC-024-3 is posted for a 10-day final ballot.

Completed Actions	Date
Standards Committee approved Standard Authorization Request (SAR) for posting	December 2018
SAR posted for comment	December 2018 – January 2019
Standards Committee accepted the revised SAR	February 2019
45-day formal comment period with ballot	April – May 2019
45-day formal or informal comment period with additional ballot	September – November 2019

Anticipated Actions	Date
10-day final ballot	December 2019
Board adoption	February 2020

A. Introduction

1. **Title:** Frequency and Voltage Protection Settings for Generating Resources
2. **Number:** PRC-024-3
3. **Purpose:** To set protection such that generating resource(s) remain connected during defined frequency and voltage excursions in support of the Bulk Electric System (BES).

4. **Applicability:**

- 4.1. **Functional Entities:**

- 4.1.1. Generator Owners that apply protection listed in Section 4.2.1.
 - 4.1.2. Transmission Owners (in the Quebec Interconnection only) that own a BES generator step-up (GSU) transformer or main power transformer (MPT)¹ and apply protection listed in Section 4.2.1.
 - 4.1.3. Planning Coordinators (in the Quebec Interconnection only)

- 4.2. **Facilities²:**

- 4.2.1 Frequency, voltage, and volts per hertz protection (whether provided by relaying or functions within associated control systems) that respond to electrical signals and: (i) directly trip the generating resource(s); or (ii) provide signals to the generating resource(s) to either trip or cease injecting current; and are applied to the following:

- 4.2.1.1 BES generating resource(s).
 - 4.2.1.2 BES GSU transformer(s).
 - 4.2.1.3 High side of the generator-connected unit auxiliary transformer³ (UAT) installed on BES generating resource(s).
 - 4.2.1.4 Individual dispersed power producing resource(s) identified in the BES Definition, Inclusion I4.
 - 4.2.1.5 Elements that are designed primarily for the delivery of capacity from the individual dispersed power producing resources identified in the BES Definition, Inclusion I4, to the

¹ For the purpose of this standard, the MPT is the power transformer that steps up voltage from the collection system voltage to the nominal transmission/interconnecting system voltage for dispersed power producing resources.

² It is not required to install or activate the protections described in Facilities Section 4.2.

³ These transformers are variably referred to as station power UAT, or station service transformer(s) used to provide overall auxiliary power to the generating resource(s). This UAT is the transformer connected on the generator bus between the low side of the GSU and the generator terminal.

point where those resources aggregate to greater than 75 MVA.

4.2.1.6 MPT⁴ of resource(s) identified in the BES Definition, Inclusion I4.

4.2.2 Exemptions: Protection on all auxiliary equipment within the generating Facility.

5. Effective Date: See Implementation Plan for PRC-024-3

⁴ For the purpose of this standard, the MPT is the power transformer that steps up voltage from the collection system voltage to the nominal transmission/interconnecting system voltage for dispersed power producing resources.

B. Requirements and Measures

- R1.** Each Generator Owner shall set its applicable frequency protection⁵ in accordance with PRC-024 Attachment 1 such that the applicable protection does not cause the generating resource to trip or cease injecting current within the “no trip zone” during a frequency excursion with the following exception: *[Violation Risk Factor: Medium]* *[Time Horizon: Long-term Planning]*
- Applicable frequency protection may be set to trip or cease injecting current within a portion of the “no trip zone” for documented and communicated regulatory or equipment limitations in accordance with Requirement R3.
- M1.** Each Generator Owner shall have evidence that the applicable frequency protection has been set in accordance with Requirement R1, such as dated setting sheets, calibration sheets, calculations, or other documentation.
- R2.** Each Generator Owner shall set its applicable voltage protection⁵ in accordance with PRC-024 Attachment 2, such that the applicable protection does not cause the generating resource to trip or cease injecting current within the “no trip zone” during a voltage excursion at the high side of the GSU or MPT, subject to the following exceptions: *[Violation Risk Factor: Medium]* *[Time Horizon: Long-term Planning]*
- If the Transmission Planner allows less stringent voltage protection settings than those required to meet PRC-024 Attachment 2, then the Generator Owner may set its protection within the voltage recovery characteristics of a location-specific Transmission Planner’s study.
 - Applicable voltage protection may be set to trip or cease injecting current during a voltage excursion within a portion of the “no trip zone” for documented and communicated regulatory or equipment limitations in accordance with Requirement R3.
- M2.** Each Generator Owner shall have evidence that applicable voltage protection has been set in accordance with Requirement R2, such as dated setting sheets, voltage-time boundaries, calibration sheets, coordination plots, dynamic simulation studies, calculations, or other documentation.
- R3.** Each Generator Owner shall document each known regulatory or equipment limitation⁶ that prevents an applicable generating resource(s) with frequency or voltage protection from meeting the protection setting criteria in Requirements R1 or R2, including (but not limited to) study results, experience from an actual event, or

⁵ Frequency, voltage, and volts per hertz protection (whether provided by relaying or functions within associated control systems) that respond to electrical signals and: (i) directly trip the generating resource(s); or (ii) provide signals to the generating resource(s) to either trip or cease injecting current.

⁶ Excludes limitations caused by the setting capability of the frequency, ~~and~~ voltage, ~~and volts per hertz~~ protective relays for the generating resource(s). ~~This but~~ does not exclude limitations originating in the equipment ~~protected by the relay. This also does not exclude limitations of that the relays protect or~~ frequency, ~~and~~ voltage, ~~and volts per hertz~~ protection embedded in control systems.

manufacturer's advice. *[Violation Risk Factor: Lower] [Time Horizon: Long-term Planning]*

3.1. The Generator Owner shall communicate the documented regulatory or equipment limitation, or the removal of a previously documented regulatory or equipment limitation, to its Planning Coordinator and Transmission Planner within 30 calendar days of any of the following:

- Identification of a regulatory or equipment limitation.
- Repair of the equipment causing the limitation that removes the limitation.
- Replacement of the equipment causing the limitation with equipment that removes the limitation.
- Creation or adjustment of an equipment limitation caused by consumption of the cumulative turbine life-time frequency excursion allowance.

M3. Each Generator Owner shall have evidence that it has documented and communicated any known regulatory or equipment limitations that resulted in an exception to Requirements R1 or R2 in accordance with Requirement R3, such as a dated email or letter that contains such documentation as study results, experience from an actual event, or manufacturer's advice.

R4. Each Generator Owner shall provide its applicable protection settings associated with Requirements R1 and R2 to the Planning Coordinator or Transmission Planner that models the associated generating resource(s) within 60 calendar days of receipt of a written request for the data and within 60 calendar days of any change to those previously requested settings unless directed by the requesting Planning Coordinator or Transmission Planner that the reporting of protection setting changes is not required. *[Violation Risk Factor: Lower] [Time Horizon: Operations Planning]*

M4. Each Generator Owner shall have evidence that it communicated applicable protection settings in accordance with Requirement R4, such as dated e-mails, correspondence or other evidence and copies of any requests it has received for that information.

C. Compliance

1. Compliance Monitoring Process

1.1. Compliance Enforcement Authority: “Compliance Enforcement Authority” means NERC or the Regional Entity, or any entity as otherwise designated by an Applicable Governmental Authority, in their respective roles of monitoring and/or enforcing compliance with mandatory and enforceable Reliability Standards in their respective jurisdictions.

1.2. Evidence Retention: The following evidence retention period(s) identify the period of time an entity is required to retain specific evidence to demonstrate compliance. For instances where the evidence retention period specified below is shorter than the time since the last audit, the Compliance Enforcement Authority may ask an entity to provide other evidence to show that it was compliant for the full-time period since the last audit.

The applicable entity shall keep data or evidence to show compliance as identified below unless directed by its Compliance Enforcement Authority to retain specific evidence for a longer period of time as part of an investigation.

- The Generator Owner shall keep data or evidence of Requirements R1 through R4 for 3 years or until the next audit, whichever is longer.
- If a Generator Owner is found non-compliant, the Generator Owner or Transmission Owner shall keep information related to the non-compliance until mitigation is complete and approved for the time period specified above, whichever is longer.

1.3. Compliance Monitoring and Enforcement Program: As defined in the NERC Rules of Procedure, “Compliance Monitoring and Enforcement Program” refers to the identification of the processes that will be used to evaluate data or information for the purpose of assessing performance or outcomes with the associated Reliability Standard.

Violation Severity Levels

R #	Violation Severity Levels			
	Lower VSL	Moderate VSL	High VSL	Severe VSL
R1.	N/A	N/A	N/A	The Generator Owner failed to set its applicable frequency protection so that it does not trip or enter momentary cessation <u>cease injecting current</u> according to Requirement R1.
R2.	N/A	N/A	N/A	The Generator Owner failed to set its applicable voltage protection so that it does not trip or enter momentary cessation <u>cease injecting current</u> according to Requirement R2.
R3.	The Generator Owner documented the known non-protection system equipment limitation that prevented it from meeting the criteria in Requirement R1 or R2 and communicated the documented limitation to its Planning Coordinator and Transmission Planner more than 30 calendar days but less than or equal to 60	The Generator Owner documented the known non-protection system equipment limitation that prevented it from meeting the criteria in Requirement R1 or R2 and communicated the documented limitation to its Planning Coordinator and Transmission Planner more than 60 calendar days but less than or equal to 90	The Generator Owner documented the known non-protection system equipment limitation that prevented it from meeting the criteria in Requirement R1 or R2 and communicated the documented limitation to its Planning Coordinator and Transmission Planner more than 90 calendar days but less than or equal to 120	The Generator Owner failed to document any known non-protection system equipment limitation that prevented it from meeting the criteria in Requirement R1 or R2. OR The Generator Owner failed to communicate the documented limitation to its Planning Coordinator and

R #	Violation Severity Levels			
	Lower VSL	Moderate VSL	High VSL	Severe VSL
	calendar days of identifying the limitation.	calendar days of identifying the limitation.	calendar days of identifying the limitation.	Transmission Planner within 120 calendar days of identifying the limitation.
R4.	<p>The Generator Owner provided its protection settings more than 60 calendar days but less than or equal to 90 calendar days of any change to those settings.</p> <p>OR</p> <p>The Generator Owner provided protection settings more than 60 calendar days but less than or equal to 90 calendar days of a written request.</p>	<p>The Generator Owner provided its protection settings more than 90 calendar days but less than or equal to 120 calendar days of any change to those settings.</p> <p>OR</p> <p>The Generator Owner provided protection settings more than 90 calendar days but less than or equal to 120 calendar days of a written request.</p>	<p>The Generator Owner provided its protection settings more than 120 calendar days but less than or equal to 150 calendar days of any change to those settings.</p> <p>OR</p> <p>The Generator Owner of provided protection settings more than 120 calendar days but less than or equal to 150 calendar days of a written request.</p>	<p>The Generator Owner failed to provide its protection settings within 150 calendar days of any change to those settings.</p> <p>OR</p> <p>The Generator Owner failed to provide protection settings within 150 calendar days of a written request.</p>

D. Regional Variances

D.A. Variance for the Quebec Interconnection

This Variance extends the applicability of Requirements R1, R3, and R4 to Transmission Owners in the Quebec Interconnection that own a BES GSU or MPT and apply protection listed in Section 4.2.1, Facilities. This Variance also replaces Requirement R2 of the continent-wide standard in its entirety and adds a new requirement, Requirement D.A.5., applicable to Planning Coordinators in the Quebec Interconnection.

In Requirements R1, R3, and R4, all references to “Generator Owner” are replaced with “Generator Owner and Transmission Owner.”

This Variance replaces continent-wide Requirement R2 in its entirety with the following:

- D.A.2.** Each Generator Owner and Transmission Owner shall set its applicable voltage protection⁵³ in accordance with PRC-024 Attachment 2a, such that the applicable protection does not cause the generating resource to trip or cease injecting current during a voltage excursion within the “no trip zone” at the high side of the GSU or MPT, subject to the following exceptions: *[Violation Risk Factor: Medium] [Time Horizon: Long-term Planning]*
- For newly designated strategic power plants, applicable protections must comply with the high voltage durations for such plants within 48 calendar months of the notification made pursuant to Requirement D.A.5. During this transition period, voltage protections must at least comply with the high voltage durations for “all power plants”.
 - The generating resource(s) are permitted to be set to trip or to cease injecting current during a voltage excursion bounded by the “no trip zone” of PRC-024 Attachment 2a for documented and communicated regulatory or equipment limitations in accordance with Requirement R3.
 - If the Transmission Planner allows less stringent voltage protection settings than those required to meet PRC-024 Attachment 2a, then the Generator Owner or Transmission Owner may set its protection within the voltage recovery characteristics of a location-specific Transmission Planner’s study.
 - Inverter-based resources voltage protection settings may be set to cease injecting current momentarily during a voltage excursion at the high side of the MPT, bounded by the “no trip zone” of PRC-024 Attachment 2a, under the following conditions:

- After a minimum delay of 0.022 s, when the positive-sequence voltage exceeds 1.25 per unit (p.u.) Normal operation must resume once the voltage drops back below 1.25 p.u at the high side of the MPT.
- After a minimum delay of 0.022 s, when the phase-to-ground root mean square (RMS) voltages exceeds 1.4 p.u., as measured at generator terminals, on one or multiple phases. Normal operation must resume once the positive-sequence voltage drops back below the 1.25 p.u. at the high side of the MPT.

M.D.A.2. Each Generator Owner and Transmission Owner shall have evidence that applicable voltage protection has been set in accordance with Requirement R2, such as dated setting sheets, voltage-time boundaries, calibration sheets, coordination plots, dynamic simulation studies, calculations, or other documentation.

This Variance adds the following Requirement:

D.A.5 Each Planning Coordinator shall designate, at least once every five calendar years, the strategic power plants that must comply with Attachment 2a and notify, within 30 calendar days of its designation, each Generator Owner or Transmission Owner that owns facilities⁷ in the strategic power plants. [*Violation Risk Factor: Medium*] [*Time Horizon: Long-term planning*]

M.D.A.5 Each Planning Coordinator shall have evidence that it designated, at least once every five calendar years, strategic power plants in accordance with Requirement D.A.5, Part 5 and shall have dated evidence that each Generator Owner or Transmission Owner has been notified in accordance with Requirement D.A.5, part 5.2. Evidence may include, but is not limited to: letters, emails, electronic files, or hard copy records demonstrating transmittal of information.

⁷ Facilities in the strategic power plants include facilities from the generator up to and including the MPT or GSU.

Violation Severity Levels

This Variance adds a VSL for D.A.5 and modifies the VSL for R2 as follows:

R #	Violation Severity Levels			
	Lower VSL	Moderate VSL	High VSL	Severe VSL
D.A.2.	N/A	N/A	N/A	<p>The Generator Owner or Transmission Owner failed to set its applicable voltage protection so that it does not trip or enter momentary cessation<u>cease injecting current</u> in accordance with Requirement D.A.2.</p> <p>OR</p> <p>The Generator Owner or Transmission Owner set its applicable voltage protection in accordance with Requirement D.A.2 but, for strategic power plants, failed to do so within 48 months of notification.</p>
D.A.5.	N/A	The Planning Coordinator designated strategic power plants at least once every five calendar years but notified each Generator Owner or Transmission Owner that owns	The Planning Coordinator designated strategic power plants at least once every five calendar years but notified each Generator Owner or Transmission Owner that owns	The Planning Coordinator failed to designate, at least once every five years, the strategic power plants that must comply with Attachment 2a.

R #	Violation Severity Levels			
	Lower VSL	Moderate VSL	High VSL	Severe VSL
		facilities in the strategic power plants between 31 days and 45 days after its designation.	facilities in the strategic power plants between 46 days and 60 days after its designation.	OR The Planning Coordinator failed to notify, each Generator Owner or Transmission Owner that owns facilities in the strategic power plants or notified them more than 60 days after the its designation.

E. Associated Documents

Implementation Plan

Version History

Version	Date	Action	Change Tracking
1	May 9, 2013	Adopted by the NERC Board of Trustees	
1	March 20, 2014	FERC Order issued approving PRC-024-1. (Order becomes effective on 7/1/16.)	
2	February 12, 2015	Adopted by the NERC Board of Trustees	Standard revised in Project 2014-01: Applicability revised to clarify application of requirements to BES dispersed power producing resources
2	May 29, 2015	FERC Letter Order in Docket No. RD15-3-000 approving PRC-024-2	Modifications to adjust the applicability to owners of dispersed generation resources.
<u>3</u>	<u>TBD</u>	<u>Adopted by the NERC Board of Trustees</u>	<u>Standard revised in Project 2018-04</u>

Attachment 1 (Frequency No Trip Boundaries by Interconnection⁸)

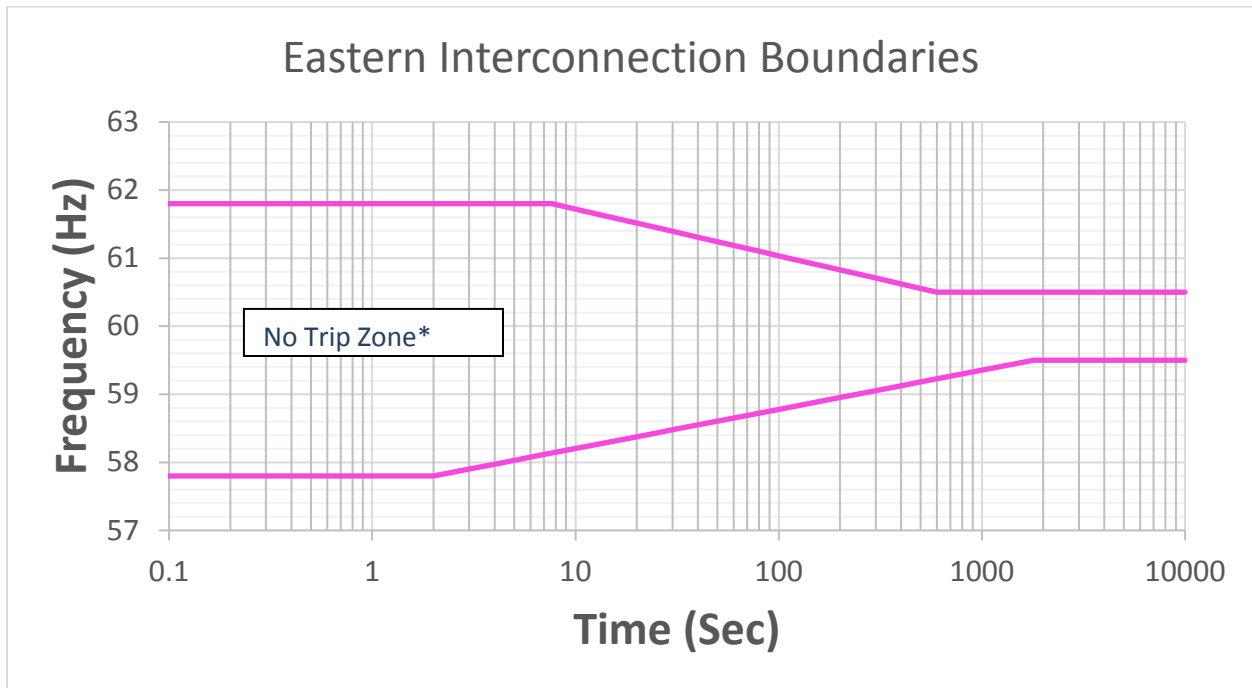

Figure 1

** The area outside the "No Trip Zone" is not a "Must Trip Zone."*

Frequency Boundary Data Points – Eastern Interconnection

High Frequency Duration		Low Frequency Duration	
Frequency (Hz)	Minimum Time (Sec)	Frequency (Hz)	Minimum Time (sec)
≥61.8	Instantaneous ⁹	≤57.8	Instantaneous ⁹
≥60.5	$10^{(90.935-1.45713*f)}$	≤59.5	$10^{(1.7373*f-100.116)}$
<60.5	Continuous operation	> 59.5	Continuous operation

Table 1

⁸ The figures do not visually represent the “no trip zone” boundaries before 0.1 seconds and after 10,000 seconds. The Frequency Boundary Data Points Table defines the entirety of the “no trip zone” boundaries.

⁹ Frequency is calculated over a window of time. While the frequency boundaries include the option to trip instantaneously for frequencies outside the specified range, this calculation should occur over a time window. Typical window/filtering lengths are three to six cycles (50 – 100 milliseconds). Instantaneous trip settings based on instantaneously calculated frequency measurement is not permissible.

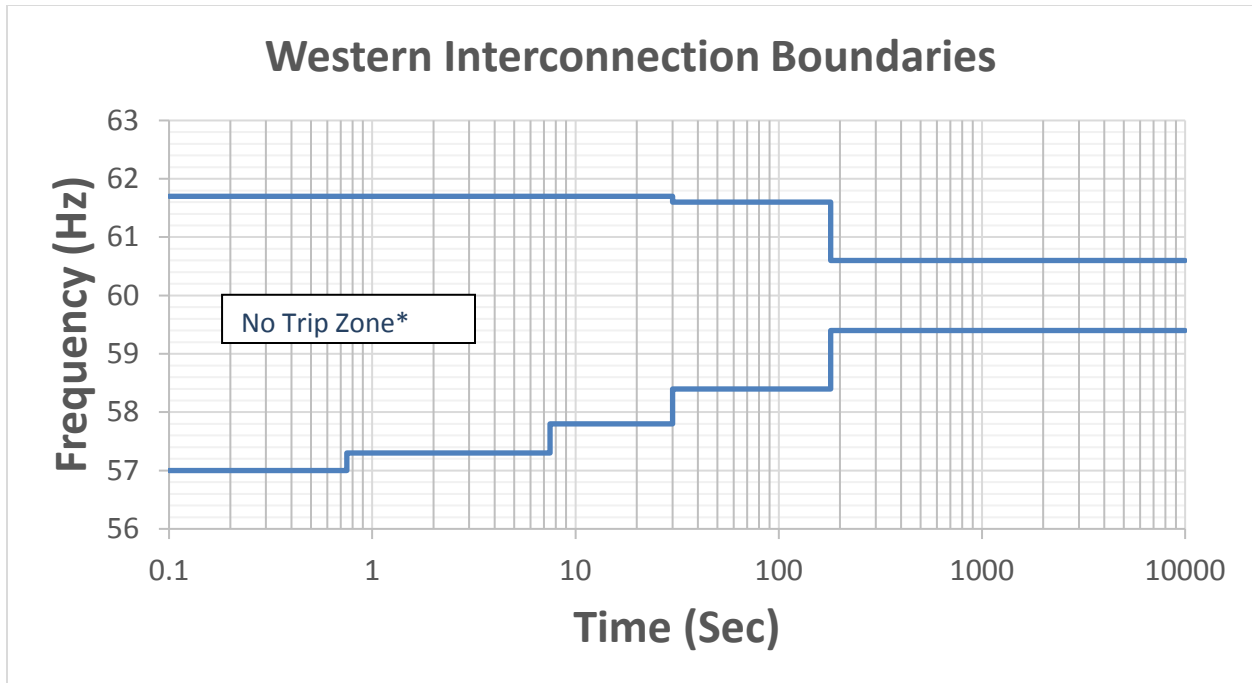

Figure 2

* The area outside the "No Trip Zone" is not a "Must Trip Zone."

Frequency Boundary Data Points – Western Interconnection

High Frequency Duration		Low Frequency Duration	
Frequency (Hz)	Minimum Time (Sec)	Frequency (Hz)	Minimum Time (sec)
≥61.7	Instantaneous ⁹	≤57.0	Instantaneous ⁹
≥61.6	30	≤57.3	0.75
≥60.6	180	≤57.8	7.5
<60.6	Continuous operation	≤58.4	30
		≤59.4	180
		>59.4	Continuous operation

Table 2

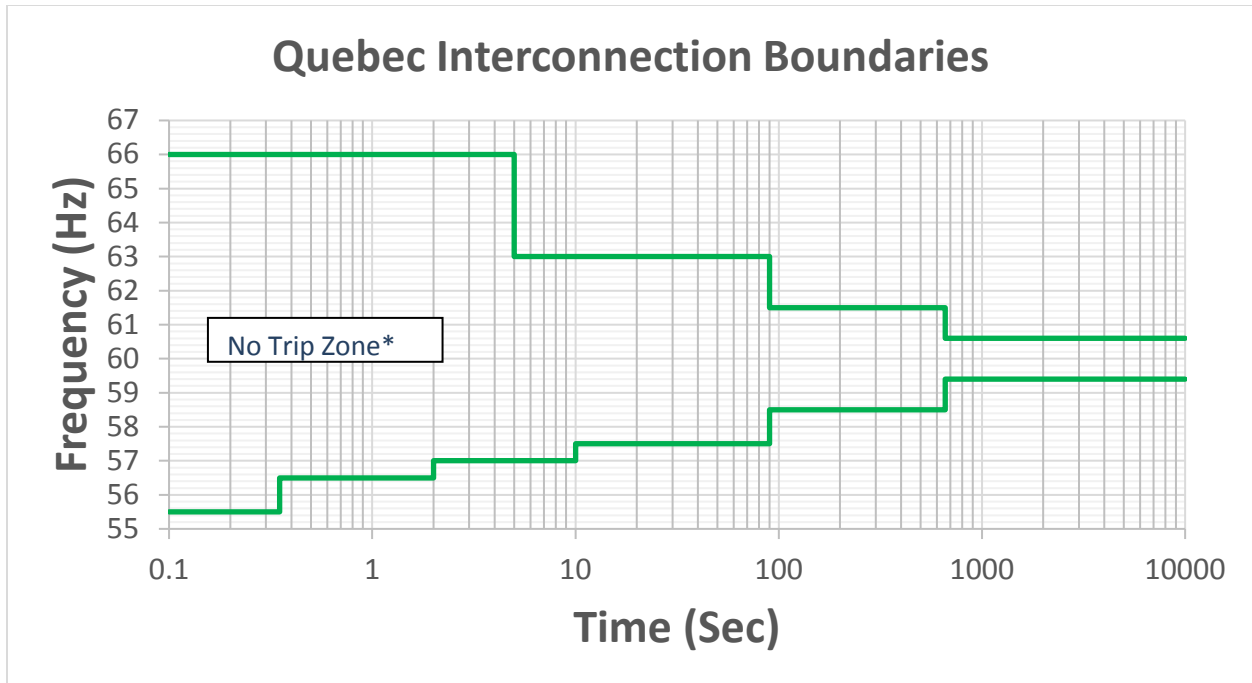

Figure 3

* The area outside the "No Trip Zone" is not a "Must Trip Zone."

Frequency Boundary Data Points – Quebec Interconnection

High Frequency Duration		Low Frequency Duration	
Frequency (Hz)	Minimum Time (Sec)	Frequency (Hz)	Minimum Time (Sec)
>66.0	Instantaneous ⁹	<55.5	Instantaneous ⁹
≥63.0	5	≤56.5	0.35
≥61.5	90	≤57.0	2
≥60.6	660	≤57.5	10
<60.6	Continuous operation	≤58.5	90
		≤59.4	660
		>59.4	Continuous operation

Table 3

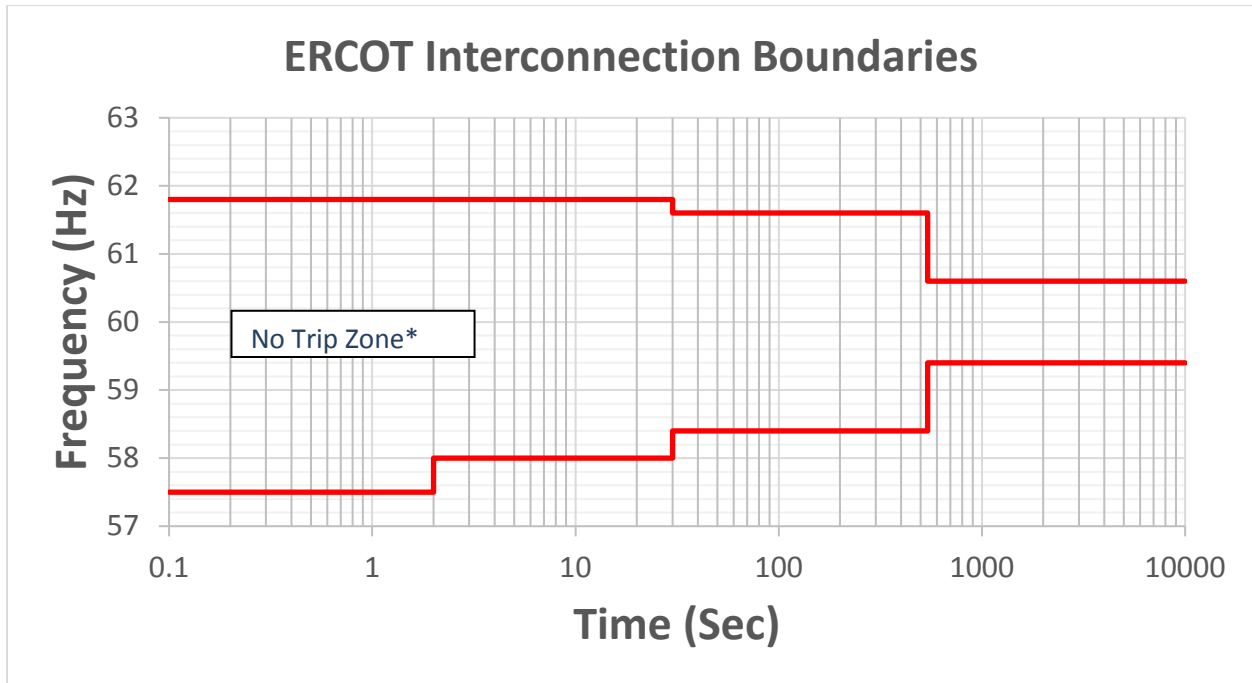

Figure 4

* The area outside the "No Trip Zone" is not a "Must Trip Zone."

Frequency Boundary Data Points – ERCOT Interconnection

High Frequency Duration		Low Frequency Duration	
Frequency (Hz)	Minimum Time (Sec)	Frequency (Hz)	Minimum Time (sec)
≥61.8	Instantaneous ⁹	≤57.5	Instantaneous ⁹
≥61.6	30	≤58.0	2
≥60.6	540	≤58.4	30
<60.6	Continuous operation	≤59.4	540
		>59.4	Continuous operation

Table 4

PRC-024 — Attachment 2

(Voltage No-Trip Boundaries – Eastern, Western, and ERCOT Interconnections)

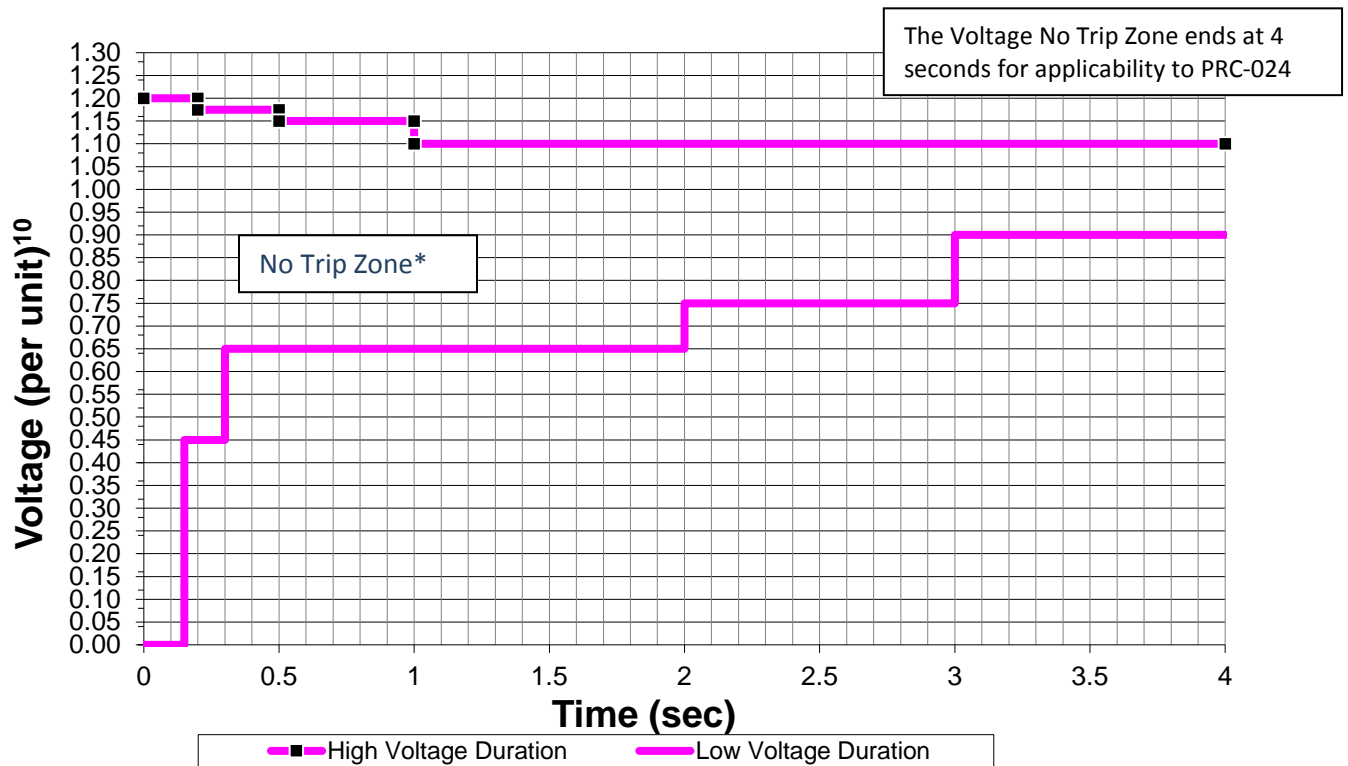

Figure 1

** The area outside the "No Trip Zone" is not a "Must Trip Zone."*

Voltage Boundary Data Points

High Voltage Duration		Low Voltage Duration	
Voltage (pu)	Minimum Time (sec)	Voltage (pu)	Minimum Time (sec)
≥1.200	0.00	<0.45	0.15
≥1.175	0.20	<0.65	0.30
≥1.15	0.50	<0.75	2.00
≥1.10	1.00	<0.90	3.00
<1.10	4.00	≥ 0.90	4.00

Table 1

¹⁰Voltage at the high-side of the GSU or MPT.

Attachment 2: Voltage Boundary Clarifications – Eastern, Western, and ERCOT Interconnections

Boundary Details:

1. Unless otherwise specified by the Transmission Planner, the per unit voltage base for these boundaries is the nominal transmission system voltage (e.g., 100 kV, 115 kV, 138 kV, 161 kV, 230 kV, 345 kV, 400 kV, 500 kV, 765 kV, etc.).
2. The values in the table represent the minimum time durations allowed for specified voltage excursion thresholds.
3. When evaluating volts per hertz protection, either assume a system frequency of 60 Hertz or the magnitude of the high voltage boundary can be adjusted in proportion to deviations of frequency below 60 Hertz.
4. Voltages in the boundaries assume RMS fundamental frequency phase-to-ground or phase-to-phase per unit voltage.
5. For applicability to PRC-024, the “no trip zone” ends at 4 seconds.

Evaluating Protection Settings:

The voltage values in the Attachment 2 voltage boundaries are voltages at the high side of the GSU/MPT. For generating resources with multiple stages of step up to reach interconnecting voltage, this is the high side of the transformer with a low side below 100kV and a high side 100kV or above. When evaluating protection settings, consider the voltage differences between where the protection is measuring voltage and the high side of the GSU/MPT. A steady state calculation or dynamic simulation may be used.

If using a steady state calculation or dynamic simulation, use the following conditions when evaluating protection settings:

- a. The most probable real and reactive loading conditions for the unit under study.
- b. All installed generating plant reactive support (e.g., static VAR compensators, synchronous condensers, capacitors) equipment is available and operating normally.
- c. Account for the actual tap settings of transformers between the generator terminals and the high side of the GSU/MPT.
- d. For dynamic simulations, the automatic voltage regulator is in automatic voltage control mode with associated limiters in service.

PRC-024— Attachment 2a (Voltage No-Trip Boundaries – Quebec Interconnection)

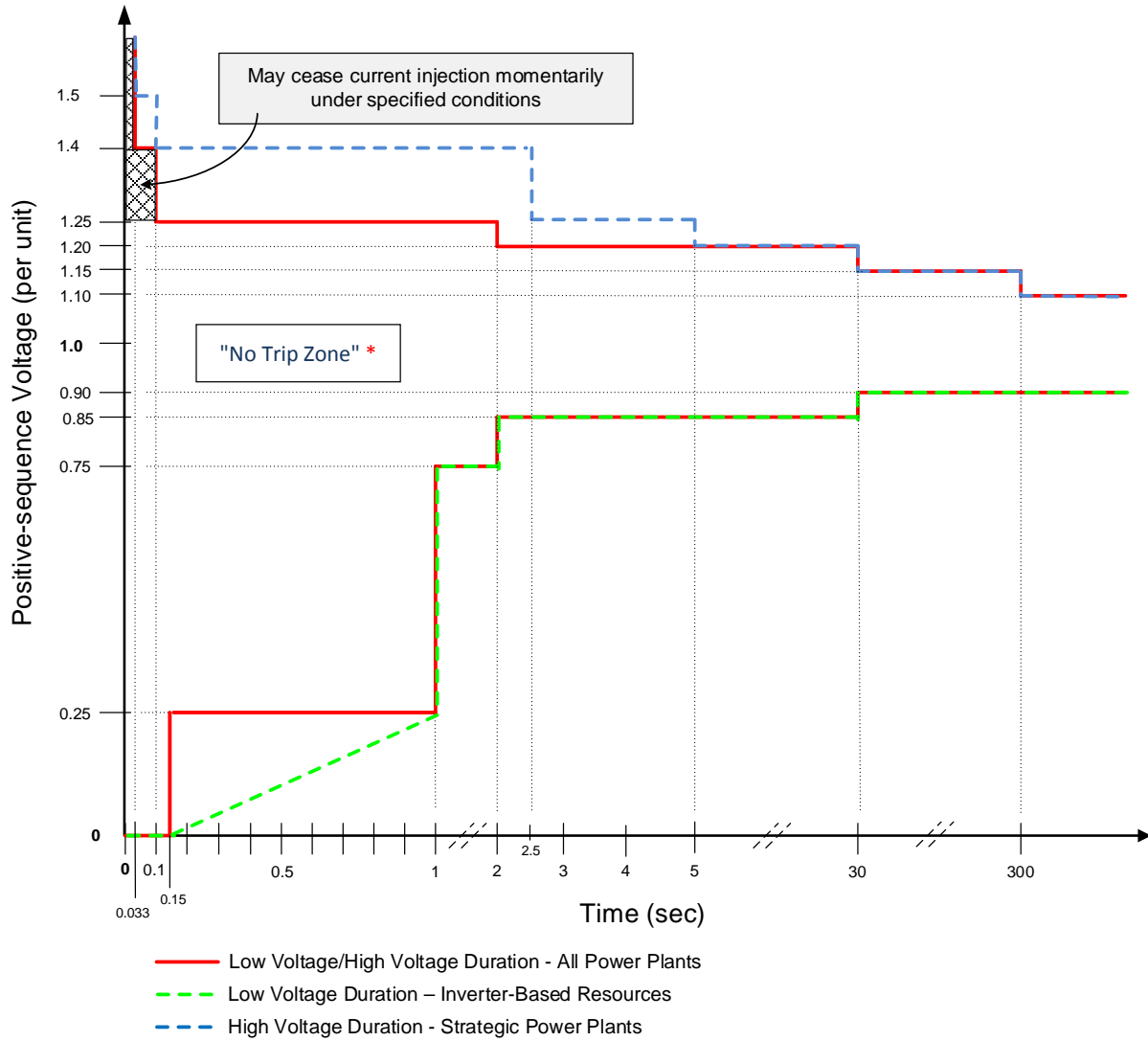

Figure 1

*** The area outside the "No Trip Zone" is not a "Must Trip Zone."**

Voltage Boundary Data Points – Quebec Interconnection

High Voltage Duration for all Power Plants		High Voltage Duration for strategic Power Plants	
Voltage (pu)	Minimum Time (sec)	Voltage (pu)	Minimum Time (sec)
---	---	>1.50	0.033
>1.40	0.033	>1.40	0.10
>1.25	0.10	>1.25	2.50
>1.20	2.00	>1.20	5.00
>1.15	30	>1.15	30
>1.10	300	>1.10	300
≤1.10	continuous	≤1.10	continuous

Table 1

Voltage Boundary Data Points – Quebec Interconnection

Low Voltage Duration for all Power Plants		Low Voltage Duration for Inverter-Based Resources	
Voltage (pu)	Minimum Time (sec)	Voltage (pu)	Minimum Time (sec)
<0.25	0.15	<0.25	$3.4 * V(\text{pu}) + 0.15$
<0.75	1.00	<0.75	1.00
<0.85	2.00	<0.85	2.00
<0.90	30	<0.90	30
≥0.90	continuous	≥0.90	continuous

Table 2

Attachment 2a: Voltage Boundary Clarifications – Quebec Interconnection

Boundary Details:

1. The per unit voltage base for these boundaries is the nominal operating voltage (e.g., 120 kV, 161 kV, 230 kV, 315 kV, 735 kV, etc.).
2. The values in the table represent the minimum time durations allowed for specified voltage excursion thresholds.
3. When evaluating volts per hertz protection, either assume a system frequency of 60 Hertz or the magnitude of the high voltage boundary can be adjusted in proportion to deviations of frequency below 60 Hertz.
4. Voltages in the Quebec Interconnection boundaries assume positive-sequence values.

Evaluating Protection Settings:

The voltage values in the Attachment 2a voltage boundaries are voltages at the high side of the GSU/MPT. For generating resources with multiple stages of step up to reach interconnecting voltage, this is the high side of the transformer that connects to the interconnecting voltage. When evaluating protection settings, consider the voltage differences between where the protection is measuring voltage and the high side of the GSU/MPT. A steady state calculation or dynamic simulation may be used.

If using a steady state calculation or dynamic simulation, use the following conditions when evaluating protection settings:

- a. The most probable real and reactive loading conditions for the unit under study.
- b. All installed generating plant reactive support (e.g., static VAR compensators, synchronous condensers, capacitors) equipment is available and operating normally.
- c. Account for the actual tap settings of transformers between the generator terminals and the high side of the GSU/MPT.
- d. For dynamic simulations, the automatic voltage regulator is in automatic voltage control mode with associated limiters in service.

Standard Development Timeline

This section is maintained by the drafting team during the development of the standard and will be removed when the standard is adopted by the NERC Board of Trustees (Board).

Description of Current Draft

PRC-024-3 is posted for a 10-day final ballot.

Completed Actions	Date
Standards Committee approved Standard Authorization Request (SAR) for posting	December 2018
SAR posted for comment	December 2018 – January 2019
Standards Committee accepted the revised SAR	February 2019
45-day formal comment period with ballot	April – May 2019
45-day formal or informal comment period with additional ballot	September – November 2019

Anticipated Actions	Date
10-day final ballot	December 2019
Board adoption	February 2020

A. Introduction

1. **Title:** ~~Generator Frequency and Voltage Protective Relay Settings for Generating Resources~~
2. **Number:** PRC-024-~~23~~
3. **Purpose:** ~~Ensure Generator Owners To set their generator protectionve relays~~ such that generating ~~resource(s) units~~ remain connected during defined frequency and voltage excursions ~~in support of the Bulk Electric System (BES).~~
4. **Applicability:**

4.1. Generator Owner Functional Entities:

4.1.1 Generator Owners that apply protection listed in Section 4.2.1.

4.1.2 Transmission Owners (in the Quebec Interconnection only) that own a BES generator step-up (GSU) transformer or main power transformer (MPT)¹ and apply protection listed in Section 4.2.1.

4.1.3 Planning Coordinators (in the Quebec Interconnection only)

4.2. Facilities²:

4.2.1 Frequency, voltage, and volts per hertz protection (whether provided by relaying or functions within associated control systems) that respond to electrical signals and: (i) directly trip the generating resource(s); or (ii) provide signals to the generating resource(s) to either trip or cease injecting current; and are applied to the following:

4.2.1.1 BES generating resource(s).

4.2.1.2 BES GSU transformer(s).

4.2.1.3 High side of the generator-connected unit auxiliary transformer³ (UAT) installed on BES generating resource(s).

4.2.1.4 Individual dispersed power producing resource(s) identified in the BES Definition, Inclusion I4.

4.2.1.5 Elements that are designed primarily for the delivery of capacity from the individual dispersed power producing resources

¹ For the purpose of this standard, the MPT is the power transformer that steps up voltage from the collection system voltage to the nominal transmission/interconnecting system voltage for dispersed power producing resources.

² It is not required to install or activate the protections described in Facilities Section 4.2.

³ These transformers are variably referred to as station power UAT, or station service transformer(s) used to provide overall auxiliary power to the generating resource(s). This UAT is the transformer connected on the generator bus between the low side of the GSU and the generator terminal.

identified in the BES Definition, Inclusion I4, to the point where those resources aggregate to greater than 75 MVA.

4.2.1.6 MPT⁴ of resource(s) identified in the BES Definition, Inclusion I4.

4.2.2 Exemptions: Protection on all auxiliary equipment within the generating Facility.

5. Effective Date: See the Implementation Plan for PRC-024-23.

⁴ For the purpose of this standard, the MPT is the power transformer that steps up voltage from the collection system voltage to the nominal transmission/interconnecting system voltage for dispersed power producing resources

~~D.B. Requirements and Measures~~

~~R1. Each Generator Owner shall set its applicable frequency protection⁵ that has generator frequency protective relaying¹ activated to trip its applicable generating unit(s) shall set its protective relaying in accordance with PRC-024 Attachment 1 such that the generator frequency protective relaying does not trip the applicable generating unit(s) protection does not cause the generating resource to trip or cease injecting current within the “no trip zone” of PRC-024 Attachment 1, subject to during a frequency excursion with the following exceptions:² [Violation Risk Factor: Medium] [Time Horizon: Long-term Planning]~~

- ~~• Generating unit(s) Applicable frequency protection may may trip if the protective functions (such as out of step functions or loss of field functions) operate due to an impending be set to trip or cease injecting current within a portion of the “no trip zone” for documented and communicated regulatory or equipment limitations in accordance with Requirement R3. actual loss of synchronism or, for asynchronous generating units, due to instability in power conversion control equipment.~~

~~Generating unit(s) may trip if clearing a system fault necessitates disconnecting (a) generating unit(s).~~

~~**M1.** Generating unit(s) may trip within a portion of the “no trip zone” of PRC-024 Attachment 1 for documented and communicated regulatory or equipment limitations in accordance~~

⁵ Frequency, voltage, and volts per hertz protection (whether provided by relaying or functions within associated control systems) that respond to electrical signals and: (i) directly trip the generating resource(s); or (ii) provide signals to the generating resource(s) to either trip or cease injecting current.

¹ Each Generator Owner is not required to have frequency or voltage protective relaying (including but not limited to frequency and voltage protective functions for discrete relays, volts per hertz relays evaluated at nominal frequency, multi-function protective devices or protective functions within control systems that directly trip or provide tripping signals to the generator based on frequency or voltage inputs) installed or activated on its unit.

² For frequency protective relays associated with dispersed power producing resources identified through Inclusion I4 of the Bulk Electric System definition, this requirement applies to frequency protective relays applied on the individual generating unit of the dispersed power producing resources, as well as frequency protective relays applied on equipment from the individual generating unit of the dispersed power producing resource up to the point of interconnection.

³ For the purposes of this standard, point of interconnection means the transmission (high voltage) side of the generator step-up or collector transformer.

⁴ For voltage protective relays associated with dispersed power producing resources identified through Inclusion I4 of the Bulk Electric System definition, this requirement applies to voltage protective relays applied on the individual generating unit of the dispersed power producing resources, as well as voltage protective relays applied on equipment from the individual generating unit of the dispersed power producing resource up to the point of interconnection.

~~with Requirement R3. Each Generator Owner shall have evidence that the generator applicable frequency protective relays have been set in accordance with Requirement R1, such as dated setting sheets, calibration sheets, calculations, or other documentation.~~

~~**R3.R2.** Each Generator Owner shall set its applicable voltage protection⁵ in accordance with PRC-024 Attachment 2, that has generator voltage protective relaying⁴ activated to trip its applicable generating unit(s) shall set its protective relaying such that the generator voltage protective relaying does not trip the applicable protection does not cause the generating resource to trip or cease injecting current within the “no trip zone” during a voltage excursion at the high side of the GSU or MPT, generating unit(s) as a result of a voltage excursion (at the point of interconnection³) caused by an event on the transmission system external to the generating plant that remains within the “no trip zone” of PRC-024 Attachment 2. ⁴If the Transmission Planner allows less stringent voltage relay settings than those required to meet PRC-024 Attachment 2, then the Generator Owner shall set its protective relaying within the voltage recovery characteristics of a location-specific Transmission Planner’s study. Requirement R2 is subject to the following exceptions: *[Violation Risk Factor: Medium] [Time Horizon: Long-term Planning]*~~

- ~~• If the Transmission Planner allows less stringent voltage protection settings than those required to meet PRC-024 Attachment 2, then the Generator Owner may set its protection within the voltage recovery characteristics of a location-specific Transmission Planner’s study.~~
- ~~• Generating unit(s) may trip in accordance with a Special Protection System (SPS) or Remedial Action Scheme (RAS).~~
- ~~• Generating unit(s) may trip if clearing a system fault necessitates disconnecting (a) generating unit(s).~~
- ~~• Generating unit(s) may trip by action of protective functions (such as out-of-step functions or loss-of-field functions) that operate due to an impending or actual loss of synchronism or, for asynchronous generating units, due to instability in power conversion control equipment.~~
- ~~• Generating unit(s) may trip by action of protective functions (such as out-of-step functions or loss-of-field functions) that operate due to an impending or actual loss of synchronism or, for asynchronous generating units, due to instability in power conversion control equipment.~~
- ~~• Applicable voltage protection may be set to trip or cease injecting current during a voltage excursion within a portion of the “no trip zone” of PRC-024 Attachment 2 for documented and communicated regulatory or equipment limitations in accordance with Requirement R3.~~

~~**M2.** Each Generator Owner shall have evidence that generator applicable voltage protective relays have been set in accordance with Requirement R2, such as dated setting sheets, voltage-time curves boundaries, calibration sheets, coordination plots, dynamic simulation studies, calculations, or other documentation.~~

R4.R3. Each Generator Owner shall document each known regulatory or equipment limitation⁶ that prevents an applicable generating ~~resource(s)~~unit with ~~generator~~ frequency or voltage protective ~~on relays~~ from meeting the ~~relay protection~~ setting criteria in Requirements R1 or R2, including (but not limited to) study results, experience from an actual event, or manufacturer's advice. *[Violation Risk Factor: Lower] [Time Horizon: Long-term Planning]*

4.1.3.1. The Generator Owner shall communicate the documented regulatory or equipment limitation, or the removal of a previously documented regulatory or equipment limitation, to its Planning Coordinator and Transmission Planner within 30 calendar days of any of the following:

- Identification of a regulatory or equipment limitation.
- Repair of the equipment causing the limitation that removes the limitation.
- Replacement of the equipment causing the limitation with equipment that removes the limitation.
- Creation or adjustment of an equipment limitation caused by consumption of the cumulative turbine life-time frequency excursion allowance.

M3. Each Generator Owner shall have evidence that it has documented and communicated any known regulatory or equipment limitations (excluding limitations noted in footnote 3) that resulted in an exception to Requirements R1 or R2 in accordance with Requirement R3, such as a dated email or letter that contains such documentation as study results, experience from an actual event, or manufacturer's advice.

R6.R4. Each Generator Owner shall provide its applicable ~~generator~~ protection ~~trip~~ settings associated with Requirements R1 and R2 to the Planning Coordinator or Transmission Planner that models the associated ~~unit-generating resource(s)~~ within 60 calendar days of receipt of a written request for the data and within 60 calendar days of any change to those previously requested ~~trip~~ settings unless directed by the requesting Planning Coordinator or Transmission Planner that the reporting of ~~relay protection~~ setting changes is not required. *[Violation Risk Factor: Lower] [Time Horizon: Operations Planning]*

~~**M3-M1.** Each Generator Owner shall have evidence that generator frequency protective relays have been set in accordance with Requirement R1 such as dated setting sheets, calibration sheets or other documentation.~~

⁶ Excludes limitations ~~that are~~ caused by the setting capability of the ~~generator~~ frequency, ~~and~~ voltage, ~~and volts per hertz~~ protective relays ~~themselves for the generating resource(s)~~. This ~~but~~ does not exclude limitations originating in the equipment ~~that they~~ protected by the relay. This also does not exclude limitations of frequency, voltage, and volts per hertz protection embedded in control systems.

Standard PRC-024-23 — ~~Generator~~ Frequency and Voltage Protective ~~Relay~~ Settings for Generating Resources

~~**M4-M1.** Each Generator Owner shall have evidence that generator voltage protective relays have been set in accordance with Requirement R2 such as dated setting sheets, voltage time curves, calibration sheets, coordination plots, dynamic simulation studies or other documentation.~~

~~**M5-M1.** Each Generator Owner shall have evidence that it has documented and communicated any known regulatory or equipment limitations (excluding limitations noted in footnote 3) that resulted in an exception to Requirements R1 or R2 in accordance with Requirement R3 such as a dated email or letter that contains such documentation as study results, experience from an actual event, or manufacturer's advice.~~

M4. Each Generator Owner shall have evidence that it communicated applicable ~~generator protective relay trip~~protection settings in accordance with Requirement R4, such as dated e-mails, correspondence or other evidence and copies of any requests it has received for that information.

E.C. Compliance

1. Compliance Monitoring Process

1.1. Compliance Enforcement Authority: “Compliance Enforcement Authority” means NERC or the Regional Entity, or any entity as otherwise designated by an Applicable Governmental Authority, in their respective roles of monitoring and/or enforcing compliance with mandatory and enforceable Reliability Standards in their respective jurisdictions.

~~The Regional Entity shall serve as the Compliance Enforcement Authority (CEA) unless the applicable entity is owned, operated, or controlled by the Regional Entity. In such cases, the ERO or a Regional Entity approved by FERC or other applicable governmental authority shall serve as the CEA.~~

~~1.3. Data Evidence Retention:~~

1.2. The following evidence retention period(s) identify the period of time an entity is required to retain specific evidence to demonstrate compliance. -For instances where the evidence retention period specified below is shorter than the time since the last audit, the Compliance Enforcement Authority may ask an entity to provide other evidence to show that it was compliant for the full-time period since the last audit.

The applicable entity shall keep data or evidence to show compliance as identified below unless directed by its Compliance Enforcement Authority to retain specific evidence for a longer period of time as part of an investigation.

- The Generator Owner shall ~~retain~~ keep data or evidence ~~of compliance with~~ Requirement R1 through R4; for 3 years or until the next audit, whichever is longer.
- If a Generator Owner is found non-compliant, the Generator Owner or Transmission Owner shall keep information related to the non-compliance until mitigation is complete and approved for the time period specified above, whichever is longer.

~~The Compliance Enforcement Authority shall keep the last audit records and all requested and submitted subsequent audit records.~~

1.6.1.3. Compliance Monitoring and Assessment Processes Program: As defined in the NERC Rules of Procedure, “Compliance Monitoring and Enforcement Program” refers to the identification of the processes that will be used to evaluate data or information for the purpose of assessing performance or outcomes with the associated Reliability Standard.

~~Compliance Audit~~

~~Self-Certification~~

~~Spot Checking~~

~~Compliance Investigations~~

~~Self-Reporting~~

~~Complaint~~

Violation Severity Levels

R #	Violation Severity Levels			
	Lower VSL	Moderate VSL	High VSL	Severe VSL
R1.	N/A	N/A	N/A	The Generator Owner that has failed to set its applicable frequency protection activated to trip a generating unit, failed to set its generator frequency protective relaying so that it does not trip within the criteria listed in or cease injecting current according to Requirement R1 unless there is a documented and communicated regulatory or equipment limitation per Requirement R3.
R2.	N/A	N/A	N/A	The Generator Owner with voltage protective relaying activated to trip a generating unit, failed to set its applicable voltage protective relaying protection so that it does not trip as a result of a voltage excursion at the point of interconnection, caused by an event external

R #	Violation Severity Levels			
	Lower VSL	Moderate VSL	High VSL	Severe VSL
				to the plant per the criteria specified in or cease injecting current according to Requirement R2 unless there is a documented and communicated regulatory or equipment limitation per Requirement R3.
R3.	The Generator Owner documented the known non-protection system equipment limitation that prevented it from meeting the criteria in Requirement R1 or R2 and communicated the documented limitation to its Planning Coordinator and Transmission Planner more than 30 calendar days but less than or equal to 60 calendar days of identifying the limitation.	The Generator Owner documented the known non-protection system equipment limitation that prevented it from meeting the criteria in Requirement R1 or R2 and communicated the documented limitation to its Planning Coordinator and Transmission Planner more than 60 calendar days but less than or equal to 90 calendar days of identifying the limitation.	The Generator Owner documented the known non-protection system equipment limitation that prevented it from meeting the criteria in Requirement R1 or R2 and communicated the documented limitation to its Planning Coordinator and Transmission Planner more than 90 calendar days but less than or equal to 120 calendar days of identifying the limitation.	The Generator Owner failed to document any known non-protection system equipment limitation that prevented it from meeting the criteria in Requirement R1 or R2. OR The Generator Owner failed to communicate the documented limitation to its Planning Coordinator and Transmission Planner within 120 calendar days of identifying the limitation.

R #	Violation Severity Levels			
	Lower VSL	Moderate VSL	High VSL	Severe VSL
R4.	<p>The Generator Owner provided its generator protection trip settings more than 60 calendar days but less than or equal to 90 calendar days of any change to those trip settings.</p> <p>OR</p> <p>The Generator Owner provided trip protection settings more than 60 calendar days but less than or equal to 90 calendar days of a written request.</p>	<p>The Generator Owner provided its generator protection trip settings more than 90 calendar days but less than or equal to 120 calendar days of any change to those trip settings.</p> <p>OR</p> <p>The Generator Owner provided protection trip settings more than 90 calendar days but less than or equal to 120 calendar days of a written request.</p>	<p>The Generator Owner provided its generator protection trip settings more than 120 calendar days but less than or equal to 150 calendar days of any change to those trip settings.</p> <p>OR</p> <p>The Generator Owner provided protection trip settings more than 120 calendar days but less than or equal to 150 calendar days of a written request.</p>	<p>The Generator Owner failed to provide its generator protection trip settings within 150 calendar days of any change to those trip settings.</p> <p>OR</p> <p>The Generator Owner failed to provide protection trip settings within 150 calendar days of a written request.</p>

F.D. Regional Variances

None

D.A. Variance for the Quebec Interconnection

This Variance extends the applicability of Requirements R1, R3, and R4 to Transmission Owners in the Quebec Interconnection that own a BES GSU or MPT and apply protection listed in Section 4.2.1, Facilities. This Variance also replaces Requirement R2 of the continent-wide standard in its entirety and adds a new requirement, Requirement D.A.5., applicable to Planning Coordinators in the Quebec Interconnection.

In Requirements R1, R3, and R4, all references to “Generator Owner” are replaced with “Generator Owner and Transmission Owner.”

This Variance replaces continent-wide Requirement R2 in its entirety with the following:

D.A.2. Each Generator Owner and Transmission Owner shall set its applicable voltage protection⁵ in accordance with PRC-024 Attachment 2a, such that the applicable protection does not cause the generating resource to trip or cease injecting current during a voltage excursion within the “no trip zone” at the high side of the GSU or MPT, subject to the following exceptions: [Violation Risk Factor: Medium] [Time Horizon: Long-term Planning]

- For newly designated strategic power plants, applicable protections must comply with the high voltage durations for such plants within 48 calendar months of the notification made pursuant to Requirement D.A.5. During this transition period, voltage protections must at least comply with the high voltage durations for “all power plants”.
- The generating resource(s) are permitted to be set to trip or to cease injecting current during a voltage excursion bounded by the “no trip zone” of PRC-024 Attachment 2a for documented and communicated regulatory or equipment limitations in accordance with Requirement R3.
- If the Transmission Planner allows less stringent voltage protection settings than those required to meet PRC-024 Attachment 2a, then the Generator Owner or Transmission Owner may set its protection within the voltage recovery characteristics of a location-specific Transmission Planner’s study.
- Inverter-based resources voltage protection settings may be set to cease injecting current momentarily during a voltage excursion at the

high side of the MPT, bounded by the “no trip zone” of PRC-024 Attachment 2a, under the following conditions:

- o After a minimum delay of 0.022 s, when the positive-sequence voltage exceeds 1.25 per unit (p.u.) Normal operation must resume once the voltage drops back below 1.25 p.u at the high side of the MPT.
- o After a minimum delay of 0.022 s, when the phase-to-ground root mean square (RMS) voltages exceeds 1.4 p.u., as measured at generator terminals, on one or multiple phases. Normal operation must resume once the positive-sequence voltage drops back below the 1.25 p.u. at the high side of the MPT.

M.D.A.2. Each Generator Owner and Transmission Owner shall have evidence that applicable voltage protection has been set in accordance with Requirement R2, such as dated setting sheets, voltage-time boundaries, calibration sheets, coordination plots, dynamic simulation studies, calculations, or other documentation.

This Variance adds the following Requirement:

D.A.5 Each Planning Coordinator shall designate, at least once every five calendar years, the strategic power plants that must comply with Attachment 2a and notify, within 30 calendar days of its designation, each Generator Owner or Transmission Owner that owns facilities⁷ in the strategic power plants. *[Violation Risk Factor: Medium] [Time Horizon: Long-term planning]*

M.D.A.5 Each Planning Coordinator shall have evidence that it designated, at least once every five calendar years, strategic power plants in accordance with Requirement D.A.5, Part 5 and shall have dated evidence that each Generator Owner or Transmission Owner has been notified in accordance with Requirement D.A.5, part 5.2. Evidence may include, but is not limited to: letters, emails, electronic files, or hard copy records demonstrating transmittal of information.

⁷ Facilities in the strategic power plants include facilities from the generator up to and including the MPT or GSU.

Violation Severity Levels

This Variance adds a VSL for D.A.5 and modifies the VSL for R2 as follows:

R #	Violation Severity Levels			
	Lower VSL	Moderate VSL	High VSL	Severe VSL
<u>D.A.2.</u>	<u>N/A</u>	<u>N/A</u>	<u>N/A</u>	<p><u>The Generator Owner or Transmission Owner failed to set its applicable voltage protection so that it does not trip or cease injecting current in accordance with Requirement D.A.2.</u></p> <p><u>OR</u></p> <p><u>The Generator Owner or Transmission Owner set its applicable voltage protection in accordance with Requirement D.A.2 but, for strategic power plants, failed to do so within 48 months of notification.</u></p>
<u>D.A.5.</u>	<u>N/A</u>	<u>The Planning Coordinator designated strategic power plants at least once every five calendar years but notified each Generator Owner or Transmission Owner that owns</u>	<u>The Planning Coordinator designated strategic power plants at least once every five calendar years but notified each Generator Owner or Transmission Owner that owns</u>	<u>The Planning Coordinator failed to designate, at least once every five years, the strategic power plants that must comply with Attachment 2a.</u>

R.#	<u>Violation Severity Levels</u>			
	<u>Lower VSL</u>	<u>Moderate VSL</u>	<u>High VSL</u>	<u>Severe VSL</u>
		<u>facilities in the strategic power plants between 31 days and 45 days after its designation.</u>	<u>facilities in the strategic power plants between 46 days and 60 days after its designation.</u>	<u>OR</u> <u>The Planning Coordinator failed to notify, each Generator Owner or Transmission Owner that owns facilities in the strategic power plants or notified them more than 60 days after the its designation.</u>

G.E. Associated Documents

~~None~~ Implementation Plan

Version History

<u>Version</u>	<u>Date</u>	<u>Action</u>	<u>Change Tracking</u>
<u>1</u>	<u>May 9, 2013</u>	<u>Adopted by the NERC Board of Trustees</u>	
<u>1</u>	<u>March 20, 2014</u>	<u>FERC Order issued approving PRC-024-1. (Order becomes effective on 7/1/16.)</u>	
<u>2</u>	<u>February 12, 2015</u>	<u>Adopted by the NERC Board of Trustees</u>	<u>Standard revised in Project 2014-01: Applicability revised to clarify application of requirements to BES dispersed power producing resources</u>
<u>2</u>	<u>May 29, 2015</u>	<u>FERC Letter Order in Docket No. RD15-3-000 approving PRC-024-2</u>	<u>Modifications to adjust the applicability to owners of dispersed generation resources.</u>
<u>3</u>	<u>TBD</u>	<u>Adopted by the NERC Board of Trustees</u>	<u>Standard revised in Project 2018-04</u>

~~H. References~~

- ~~1. “The Technical Justification for the New WECC Voltage Ride-Through (VRT) Standard, A White Paper Developed by the Wind Generation Task Force (WGTF),” dated June 13, 2007, a guideline approved by WECC Technical Studies Subcommittee.~~

PRC-024 — Attachment 1

OFF NOMINAL FREQUENCY CAPABILITY CURVE

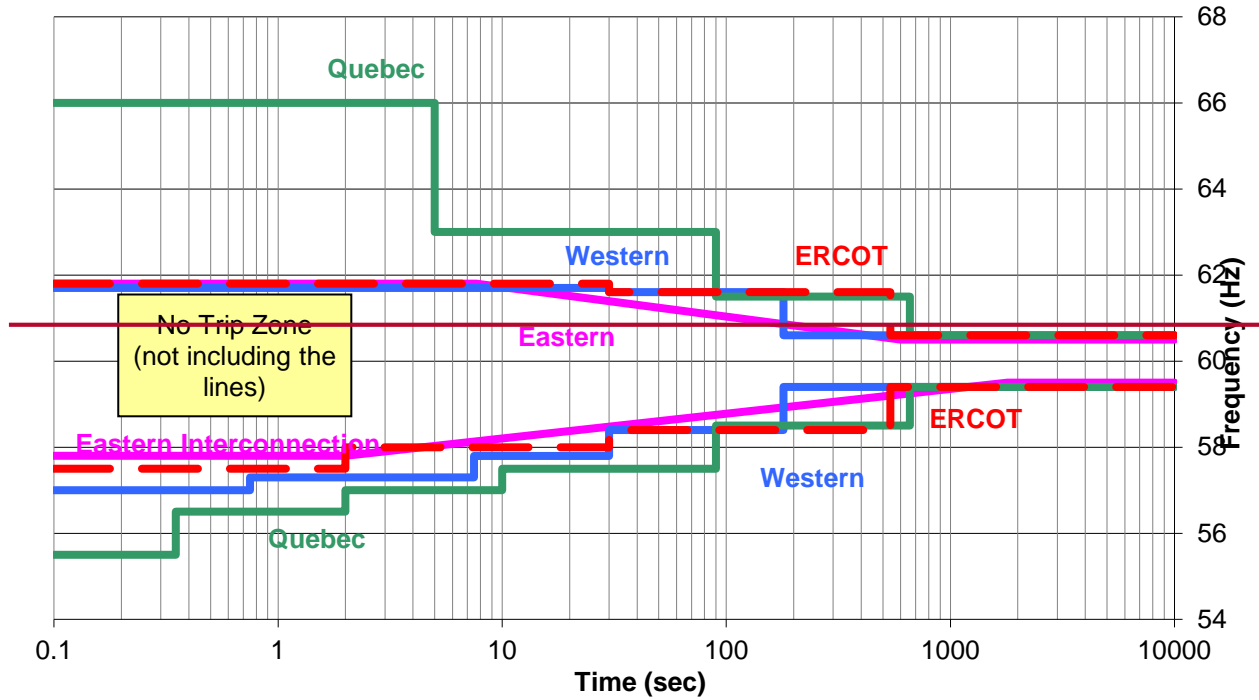

(Frequency No Trip Boundaries by Interconnection⁸)

⁸ The figures do not visually represent the “no trip zone” boundaries before 0.1 seconds and after 10,000 seconds. The Frequency Boundary Data Points Table defines the entirety of the “no trip zone” boundaries.

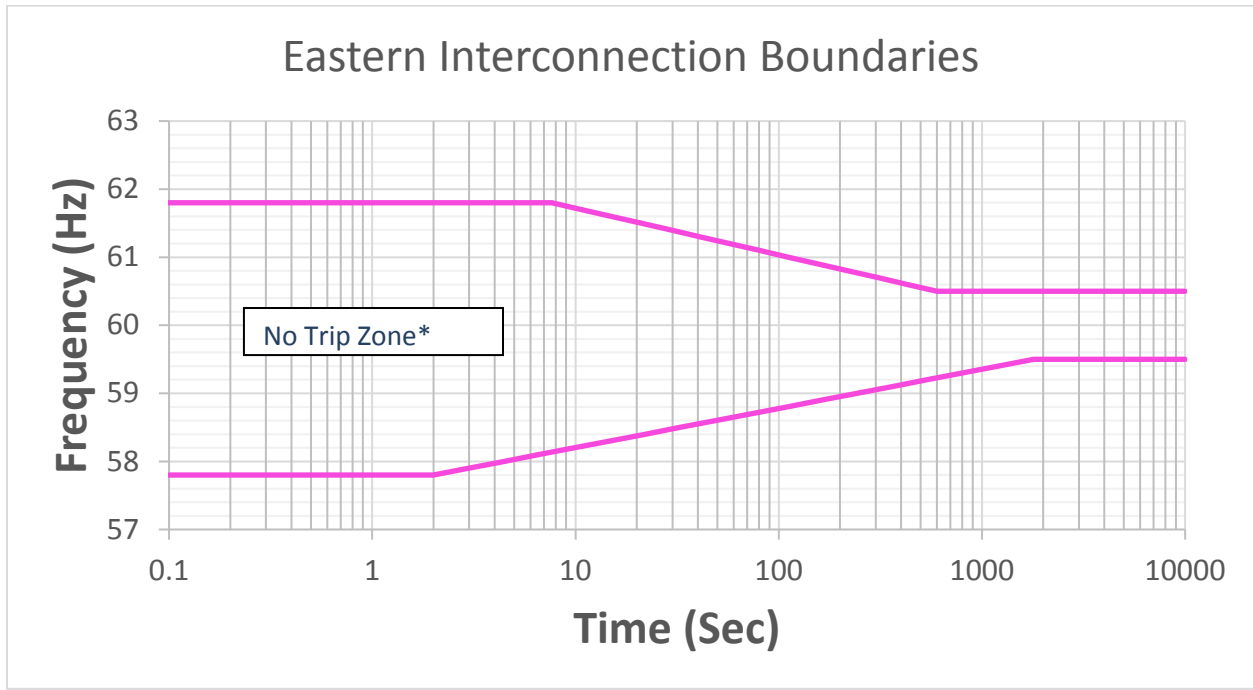

Figure 1

** The area outside the "No Trip Zone" is not a "Must Trip Zone."*

Curve-Frequency Boundary Data Points:

- Eastern Interconnection

High Frequency Duration		Low Frequency Duration	
Frequency (Hz)	Minimum Time (Sec)	Frequency (Hz)	Minimum Time (sec)
≥61.8	Instantaneous ⁹ trip	≤57.8	Instantaneous ⁹ trip
≥60.5	$10^{(90.935-1.45713*f)}$	≤59.5	$10^{(1.7373*f-100.116)}$
<60.5	Continuous operation	> 59.5	Continuous operation

Table 1

⁹ Frequency is calculated over a window of time. While the frequency boundaries include the option to trip instantaneously for frequencies outside the specified range, this calculation should occur over a time window. Typical window/filtering lengths are three to six cycles (50 – 100 milliseconds). Instantaneous trip settings based on instantaneously calculated frequency measurement is not permissible.

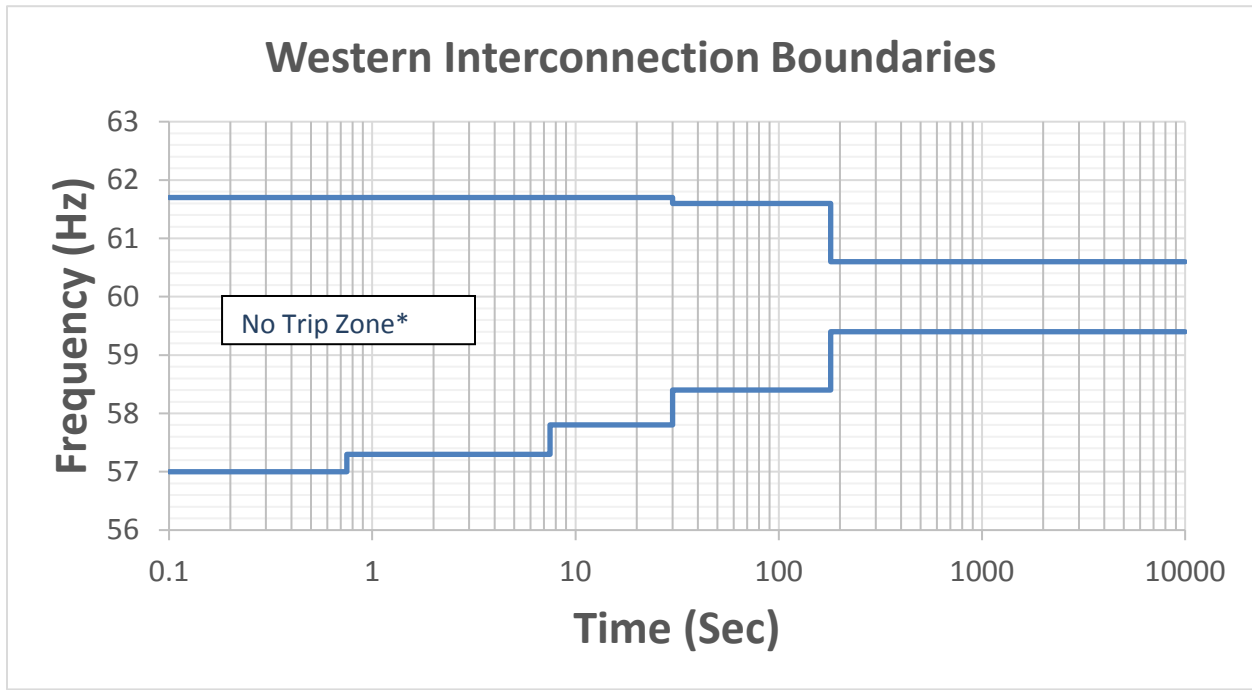

Figure 2

* The area outside the "No Trip Zone" is not a "Must Trip Zone."

Frequency Boundary Data Points –Western Interconnection

High Frequency Duration		Low Frequency Duration	
Frequency (Hz)	Minimum Time (Sec)	Frequency (Hz)	Minimum Time (sec)
≥61.7	Instantaneous ⁹ trip	≤57.0	Instantaneous ⁹ trip
≥61.6	30	≤57.3	0.75
≥60.6	180	≤57.8	7.5
<60.6	Continuous operation	≤58.4	30
		≤59.4	180
		>59.4	Continuous operation

Table 2

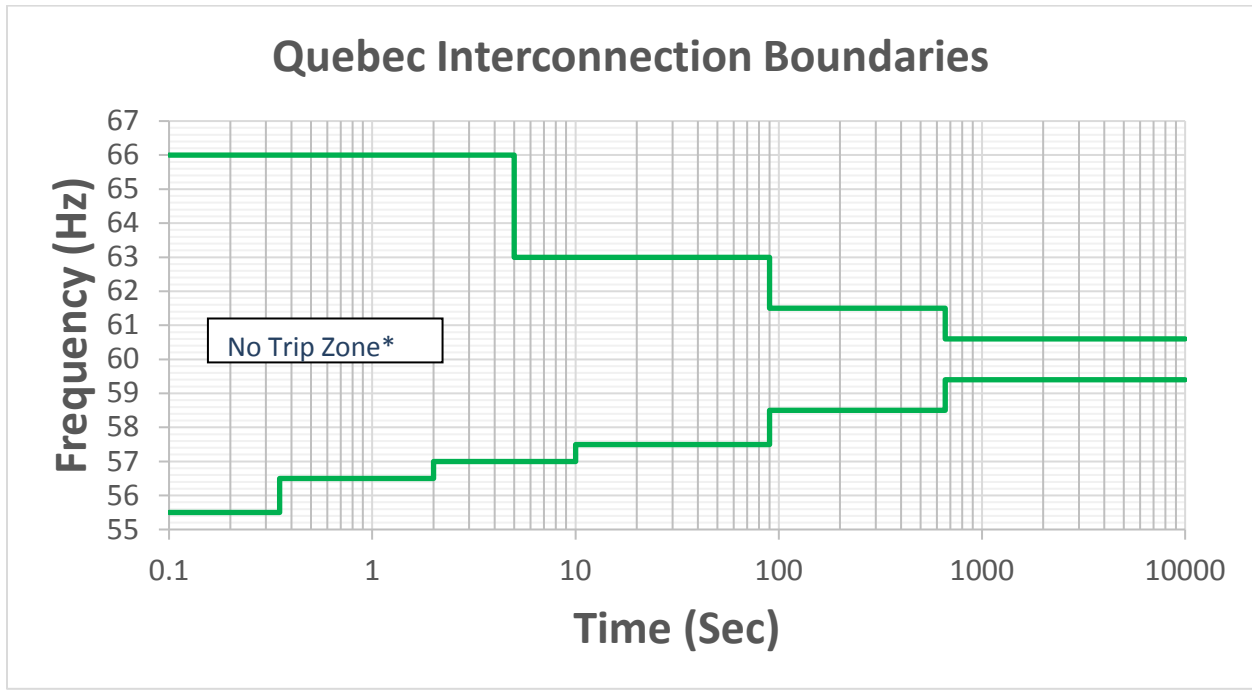

Figure 3

** The area outside the "No Trip Zone" is not a "Must Trip Zone."*

Frequency Boundary Data Points – Quebec Interconnection

High Frequency Duration		Low Frequency Duration	
Frequency (Hz)	Minimum Time (Sec)	Frequency (Hz)	Minimum Time (Sec)
>66.0	Instantaneous ⁹ trip	<55.5	Instantaneous ⁹ trip
≥63.0	5	≤56.5	0.35
≥61.5	90	≤57.0	2
≥60.6	660	≤57.5	10
<60.6	Continuous operation	≤58.5	90
		≤59.4	660
		>59.4	Continuous operation

Table 3

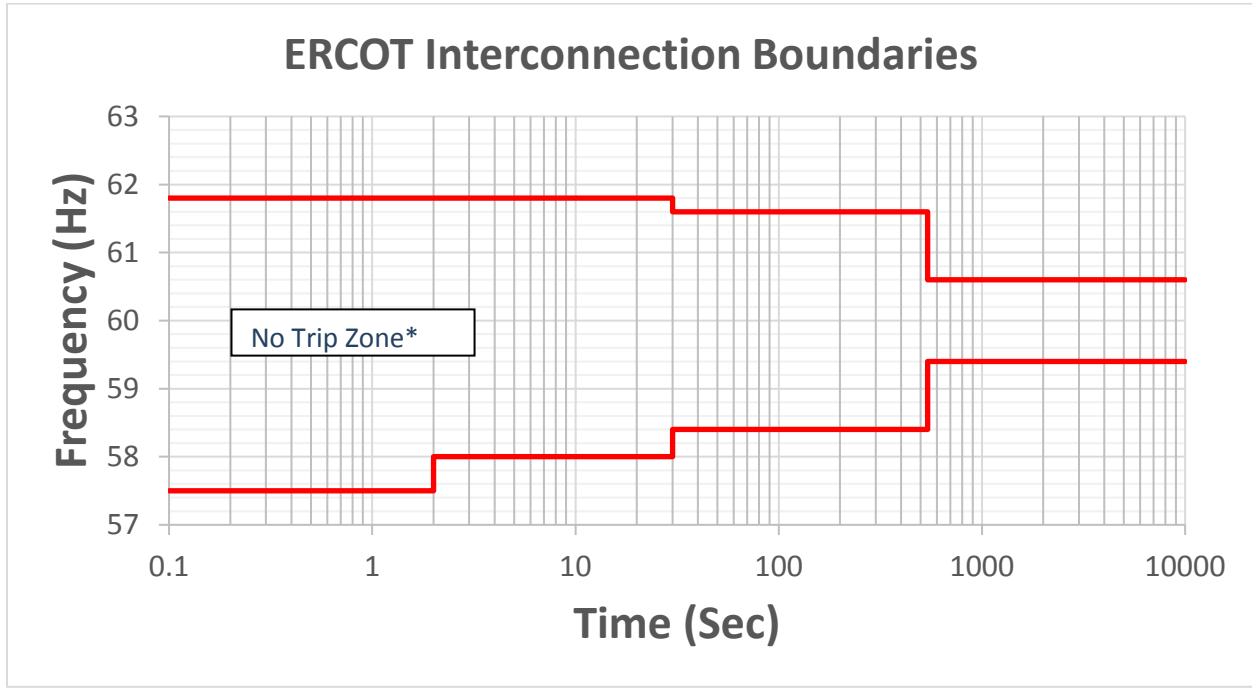

Figure 4

* The area outside the "No Trip Zone" is not a "Must Trip Zone."

Frequency Boundary Data Points – ERCOT Interconnection

High Frequency Duration		Low Frequency Duration	
Frequency (Hz)	Minimum Time (Sec)	Frequency (Hz)	Minimum Time (sec)
≥61.8	Instantaneous ⁹ trip	≤57.5	Instantaneous ⁹ trip
≥61.6	30	≤58.0	2
≥60.6	540	≤58.4	30
<60.6	Continuous operation	≤59.4	540
		>59.4	Continuous operation

Table 4

~~PRC-024 — Attachment 2~~

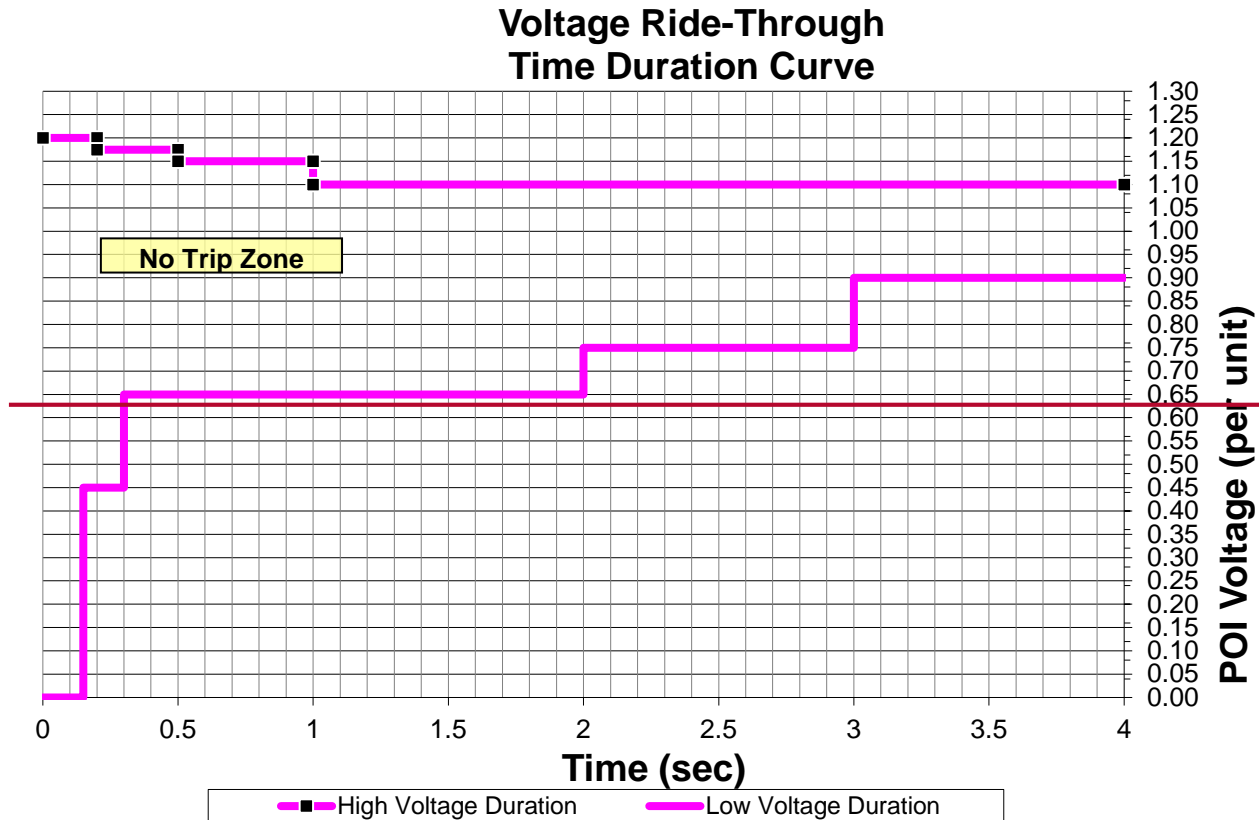

~~Ride Through Duration:~~

PRC-024 — Attachment 2
(Voltage No-Trip Boundaries – Eastern, Western, and ERCOT Interconnections)

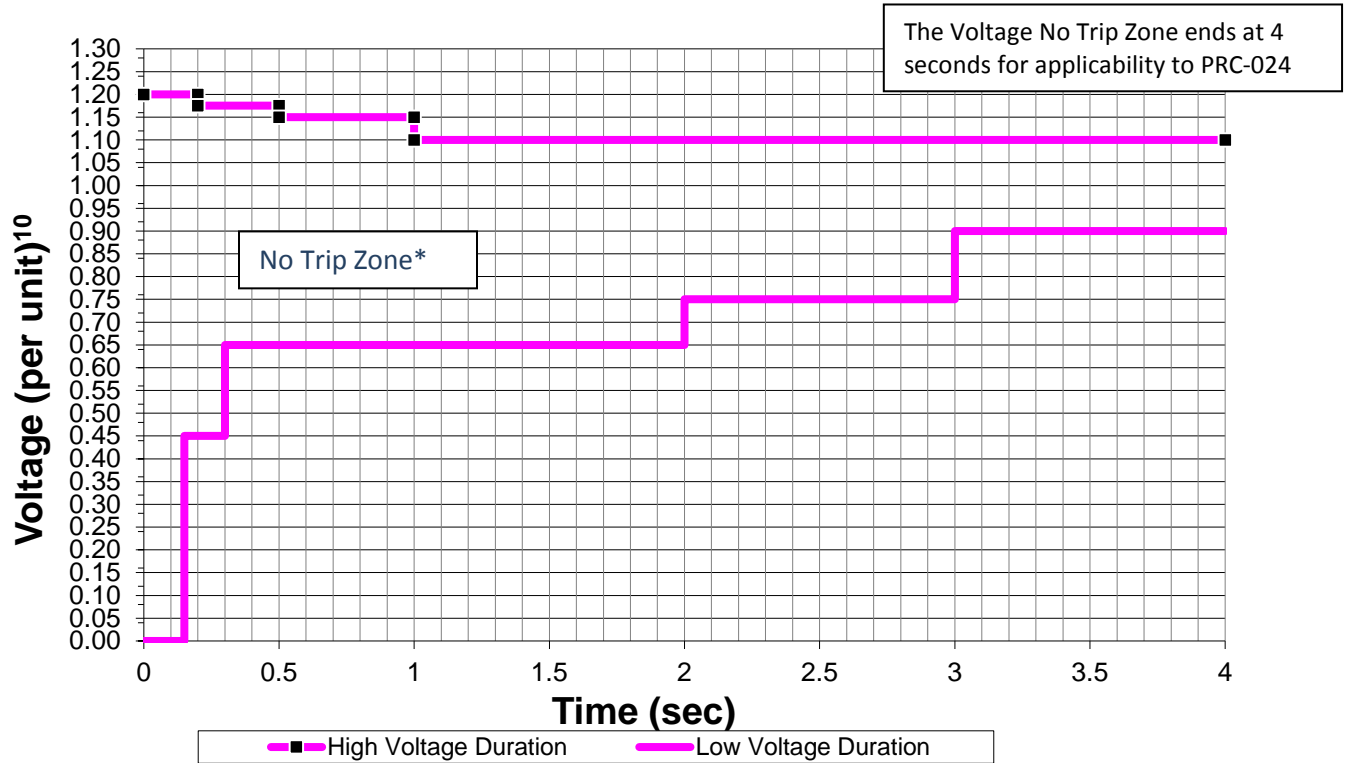

Figure 1

** The area outside the "No Trip Zone" is not a "Must Trip Zone."*

Voltage Boundary Data Points

High Voltage Duration		Low Voltage Duration	
Voltage (pu)	Minimum Time (sec)	Voltage (pu)	Minimum Time (sec)
≥ 1.200	<u>0.00</u>	< 0.45	<u>0.15</u>
≥ 1.175	<u>0.20</u>	< 0.65	<u>0.30</u>
≥ 1.15	<u>0.50</u>	< 0.75	<u>2.00</u>
≥ 1.10	<u>1.00</u>	< 0.90	<u>3.00</u>
< 1.10	<u>4.00</u>	≥ 0.90	<u>4.00</u>

Table 1

¹⁰Voltage at the high-side of the GSU or MPT.

Attachment 2: Voltage Ride-Through Curve Boundary Clarifications — Eastern, Western, and ERCOT Interconnections

Curve

Boundary Details:

- ~~1. The per unit voltage base for these curves is the nominal operating voltage. Unless otherwise specified by the Transmission Planner in the analysis of the reliability of the Interconnected Transmission Systems at the point of interconnection to the Bulk Electric System (BES).~~
- ~~2.1. The curves depicted were derived based on three phase, the per unit voltage base for these boundaries is the nominal transmission system zone 1 faults with Normal Clearing not exceeding 9 cycles. The curves apply to voltage excursions regardless of the type of initiating event. voltage (e.g., 100 kV, 115 kV, 138 kV, 161 kV, 230 kV, 345 kV, 400 kV, 500 kV, 765 kV, etc.).~~
- ~~3. The envelope within the curves represents the cumulative voltage duration at the point of interconnection with the BES. For example, if the voltage first exceeds 1.15 pu at 0.3 seconds after a fault, does not exceed 1.2 pu voltage, and returns below 1.15 pu at 0.4 seconds, then the cumulative time the voltage is above 1.15 pu voltage is 0.1 seconds and is within the no trip zone of the curve.~~
- ~~2. The curves depicted. The values in the table represent the minimum time durations allowed for specified voltage excursion thresholds.~~
- ~~4.3. When evaluating volts per hertz protection, either assume a system frequency is of 60 Hertz. When evaluating Volts/Hertz protection, you may adjust or the magnitude of the high voltage curve boundary can be adjusted in proportion to deviations of frequency below 60 Hz. Hertz.~~
- ~~5.4. Voltages in the curve boundaries assume minimum RMS fundamental frequency phase-to-ground or phase-to-phase voltage for the low voltage duration curve and the greater of maximum RMS or crest phase to phase voltage for the high voltage duration curve per unit voltage.~~
- ~~5. For applicability to PRC-024, the “no trip zone” ends at 4 seconds.~~

Evaluating Protective Relay Protection Settings:

~~Use either. The voltage values in the Attachment 2 voltage boundaries are voltages at the high side of the GSU/MPT. For generating resources with multiple stages of step up to reach interconnecting voltage, this is the high side of the transformer with a low side below 100kV and a high side 100kV or above. When evaluating protection settings, consider the voltage differences between where the protection is measuring voltage and the high side of the GSU/MPT. A steady state calculation or dynamic simulation may be used.~~

~~If using a steady state calculation or dynamic simulation, use the following assumptions or conditions when evaluating protection settings:~~

- a. The most probable real and reactive loading conditions that are believed to be the most probable for the unit under study to evaluate voltage protection relay setting calculations on the static case for steady state initial conditions:
 - ~~b. All of the units connected to the same transformer are online and operating.~~
 - ~~c. All of the units are at full nameplate real power output.~~
 - ~~d. Power factor is 0.95 lagging (i.e. supplying reactive power to the system) as measured at the generator terminals.~~
 - ~~e. The automatic voltage regulator is in automatic voltage control mode.~~
- b. Evaluate voltage protection relay settings assuming that additional ~~All~~ installed generating plant reactive support ~~equipment (such as (e.g., static VAR VAR compensators, synchronous condensers, or capacitors)~~ equipment is available and operating normally.
- c. Account for the actual tap settings of transformers between the generator terminals and the high side of the GSU/MPT.
- d. For dynamic simulations, the automatic voltage regulator is in automatic voltage control mode with associated limiters in service.

PRC-024— Attachment 2a
(Voltage No-Trip Boundaries – Quebec Interconnection)

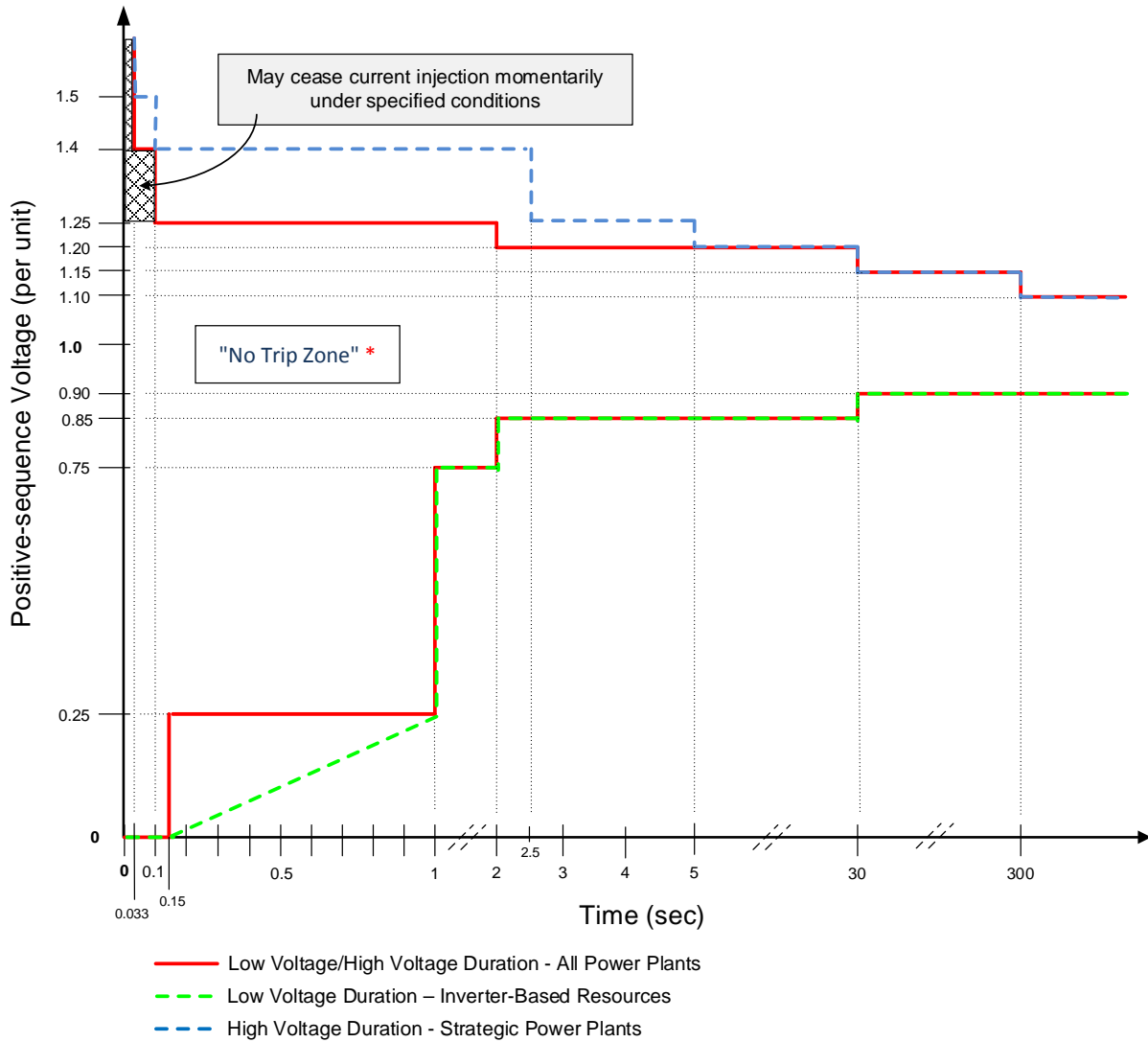

Figure 1

**** The area outside the "No Trip Zone" is not a "Must Trip Zone."***

Voltage Boundary Data Points – Quebec Interconnection

<u>High Voltage Duration for all Power Plants</u>		<u>High Voltage Duration for strategic Power Plants</u>	
<u>Voltage (pu)</u>	<u>Minimum Time (sec)</u>	<u>Voltage (pu)</u>	<u>Minimum Time (sec)</u>
<u>---</u>	<u>---</u>	<u>>1.50</u>	<u>0.033</u>
<u>>1.40</u>	<u>0.033</u>	<u>>1.40</u>	<u>0.10</u>
<u>>1.25</u>	<u>0.10</u>	<u>>1.25</u>	<u>2.50</u>
<u>>1.20</u>	<u>2.00</u>	<u>>1.20</u>	<u>5.00</u>
<u>>1.15</u>	<u>30</u>	<u>>1.15</u>	<u>30</u>
<u>>1.10</u>	<u>300</u>	<u>>1.10</u>	<u>300</u>
<u>≤1.10</u>	<u>continuous</u>	<u>≤1.10</u>	<u>continuous</u>

Table 1

Voltage Boundary Data Points – Quebec Interconnection

<u>Low Voltage Duration for all Power Plants</u>		<u>Low Voltage Duration for Inverter-Based Resources</u>	
<u>Voltage (pu)</u>	<u>Minimum Time (sec)</u>	<u>Voltage (pu)</u>	<u>Minimum Time (sec)</u>
<u><0.25</u>	<u>0.15</u>	<u><0.25</u>	<u>3.4*V(pu)+0.15</u>
<u><0.75</u>	<u>1.00</u>	<u><0.75</u>	<u>1.00</u>
<u><0.85</u>	<u>2.00</u>	<u><0.85</u>	<u>2.00</u>
<u><0.90</u>	<u>30</u>	<u><0.90</u>	<u>30</u>
<u>≥0.90</u>	<u>continuous</u>	<u>≥0.90</u>	<u>continuous</u>

Table 2

Attachment 2a: Voltage Boundary Clarifications – Quebec Interconnection

Boundary Details:

1. The per unit voltage base for these boundaries is the nominal operating voltage (e.g., 120 kV, 161 kV, 230 kV, 315 kV, 735 kV, etc.).
2. The values in the table represent the minimum time durations allowed for specified voltage excursion thresholds.
3. When evaluating volts per hertz protection, either assume a system frequency of 60 Hertz or the magnitude of the high voltage boundary can be adjusted in proportion to deviations of frequency below 60 Hertz.
4. Voltages in the Quebec Interconnection boundaries assume positive-sequence values.

Evaluating Protection Settings:

The voltage values in the Attachment 2a voltage boundaries are voltages at the high side of the GSU/MPT. For generating resources with multiple stages of step up to reach interconnecting voltage, this is the high side of the transformer that connects to the interconnecting voltage. When evaluating protection settings, consider the voltage differences between where the protection is measuring voltage and the high side of the GSU/MPT. A steady state calculation or dynamic simulation may be used.

If using a steady state calculation or dynamic simulation, use the following conditions when evaluating protection settings:

- a. The most probable real and reactive loading conditions for the unit under study.
- b. All installed generating plant reactive support (e.g., static VAR compensators, synchronous condensers, capacitors) equipment is available and operating normally.
- c. Account for the actual tap settings of transformers between the generator terminals and the high side of the GSU/MPT.
- d. For dynamic simulations, the automatic voltage regulator is in automatic voltage control mode with associated limiters in service.

~~During development of this standard, text boxes were embedded within the standard to explain the rationale for various parts of the standard. Upon BOT approval, the text from the rationale text boxes was moved to this section.~~

~~Rationale for Footnotes 2 and 4~~

~~Standard Standard-PRC-024-23 — Generator Frequency and Voltage Protective Relay Settings for Generating Resources~~ Generator Frequency and Voltage Protective Relay Settings

~~The SDT has determined it is appropriate to require that protective relay settings applied on both the individual generating units and aggregating equipment (including any non-Bulk Electric System collection system equipment) are set respecting the “no-trip zone” referenced in the requirements to maintain reliability of the BES. If any of the protective relay settings applied on these elements of the facility were to be excluded from this standard, the potential would exist for portions of or the entire generating capacity of the dispersed power producing facility to be lost during a voltage or frequency excursion.~~

Implementation Plan

Project 2018-04 Modifications to PRC-024-2 Reliability Standard PRC-024-3

Applicable Standard

- Reliability Standard PRC-024-3 –Frequency and Voltage Protection Settings for Generating Resources

Requested Retirement

- Reliability Standard PRC-024-2 – Generator Frequency and Voltage Protective Relay Settings

Prerequisite Standard(s)

- None

Applicable Entities

- Generator Owners that apply protection listed in Section 4.2.1.
- Transmission Owners (in the Quebec Interconnection only) that own a BES generator step-up (GSU) transformer or main power transformer (MPT) and apply protection listed in Section 4.2.1.
- Planning Coordinators (in the Quebec Interconnection only)

Background

Reliability Standard PRC-024-3 contains a series of revisions and clarifications intended to help ensure that inverter-based resources respond to grid disturbances in a manner that contributes to the reliable operation of the Bulk-Power System.

The standard was revised to address recommendations of the NERC Inverter-Based Resource Performance Task Force. These recommendations were developed in response to the findings and recommendations of the NERC and WECC analysis of the [Blue Cut Fire](#) and [Canyon 2 Fire](#) disturbances in southern California.

In addition, the standard includes a Regional Variance for the Quebec Interconnection and related revisions to clarify the applicability of the standard in that Interconnection.

General Considerations

This Implementation Plan is intended to provide applicable entities with sufficient time to evaluate settings, make changes for applicable equipment, and purchase necessary equipment, if necessary.

Setting changes and equipment installations are typically completed during generating Facility outages, which may be scheduled in up to twenty-four (24) month intervals.

Effective Date

Reliability Standard PRC-024-3

Where approval by an applicable governmental authority is required, the standard shall become effective on the first day of the first calendar quarter that is twenty-four (24) months after the effective date of the applicable governmental authority's order approving the standard, or as otherwise provided for by the applicable governmental authority.

Where approval by an applicable governmental authority is not required, the standard shall become effective on the first day of the first calendar quarter that is twenty-four (24) months after the date the standard is adopted by the NERC Board of Trustees, or as otherwise provided for in that jurisdiction.

Retirement Date

Reliability Standard PRC-024-2

Reliability Standard PRC-024-2 shall be retired immediately prior to the effective date of Reliability Standard PRC-024-3 in the particular jurisdiction in which the revised standard is becoming effective.

Violation Risk Factor and Violation Severity Level Justifications

Project 2018-04 Modifications to PRC-024-2 December 2019

This document provides the standard drafting team's (SDT's) justification for assignment of violation risk factors (VRFs) and violation severity levels (VSLs) for each requirement in Reliability Standard PRC-024-3. Each requirement is assigned a VRF and a VSL. These elements support the determination of an initial value range for the Base Penalty Amount regarding violations of requirements in FERC-approved Reliability Standards, as defined in the Electric Reliability Organizations (ERO) Sanction Guidelines. The SDT applied the following NERC criteria and FERC Guidelines when developing the VRFs and VSLs for the requirements.

NERC Criteria for Violation Risk Factors

High Risk Requirement

A requirement that, if violated, could directly cause or contribute to Bulk Electric System instability, separation, or a cascading sequence of failures, or could place the Bulk Electric System at an unacceptable risk of instability, separation, or cascading failures; or, a requirement in a planning time frame that, if violated, could, under emergency, abnormal, or restorative conditions anticipated by the preparations, directly cause or contribute to Bulk Electric System instability, separation, or a cascading sequence of failures, or could place the Bulk Electric System at an unacceptable risk of instability, separation, or cascading failures, or could hinder restoration to a normal condition.

Medium Risk Requirement

A requirement that, if violated, could directly affect the electrical state or the capability of the Bulk Electric System, or the ability to effectively monitor and control the Bulk Electric System. However, violation of a medium risk requirement is unlikely to lead to Bulk Electric System instability, separation, or cascading failures; or, a requirement in a planning time frame that, if violated, could, under emergency, abnormal, or restorative conditions anticipated by the preparations, directly and adversely affect the electrical state or capability of the Bulk Electric System, or the ability to effectively monitor, control, or restore the Bulk Electric System. However, violation of a medium risk requirement is unlikely, under emergency, abnormal, or restoration conditions anticipated by the preparations, to lead to Bulk Electric System instability, separation, or cascading failures, nor to hinder restoration to a normal condition.

Lower Risk Requirement

A requirement that is administrative in nature and a requirement that, if violated, would not be expected to adversely affect the electrical state or capability of the Bulk Electric System, or the ability to effectively monitor and control the Bulk Electric System; or, a requirement that is administrative in nature and a requirement in a planning time frame that, if violated, would not, under the emergency, abnormal, or restorative conditions anticipated by the preparations, be expected to adversely affect the electrical state or capability of the Bulk Electric System, or the ability to effectively monitor, control, or restore the Bulk Electric System.

FERC Guidelines for Violation Risk Factors

Guideline (1) – Consistency with the Conclusions of the Final Blackout Report

FERC seeks to ensure that VRFs assigned to Requirements of Reliability Standards in these identified areas appropriately reflect their historical critical impact on the reliability of the Bulk-Power System. In the VSL Order, FERC listed critical areas (from the Final Blackout Report) where violations could severely affect the reliability of the Bulk-Power System:

- Emergency operations
- Vegetation management
- Operator personnel training
- Protection systems and their coordination
- Operating tools and backup facilities
- Reactive power and voltage control
- System modeling and data exchange
- Communication protocol and facilities
- Requirements to determine equipment ratings
- Synchronized data recorders
- Clearer criteria for operationally critical facilities
- Appropriate use of transmission loading relief.

Guideline (2) – Consistency within a Reliability Standard

FERC expects a rational connection between the sub-Requirement VRF assignments and the main Requirement VRF assignment.

Guideline (3) – Consistency among Reliability Standards

FERC expects the assignment of VRFs corresponding to Requirements that address similar reliability goals in different Reliability Standards would be treated comparably.

Guideline (4) – Consistency with NERC’s Definition of the Violation Risk Factor Level

Guideline (4) was developed to evaluate whether the assignment of a particular VRF level conforms to NERC’s definition of that risk level.

Guideline (5) – Treatment of Requirements that Co-mingle More Than One Obligation

Where a single Requirement co-mingles a higher risk reliability objective and a lesser risk reliability objective, the VRF assignment for such Requirements must not be watered down to reflect the lower risk level associated with the less important objective of the Reliability Standard.

NERC Criteria for Violation Severity Levels

VSLs define the degree to which compliance with a requirement was not achieved. Each requirement must have at least one VSL. While it is preferable to have four VSLs for each requirement, some requirements do not have multiple “degrees” of noncompliant performance and may have only one, two, or three VSLs.

VSLs should be based on NERC’s overarching criteria shown in the table below:

Lower VSL	Moderate VSL	High VSL	Severe VSL
The performance or product measured almost meets the full intent of the requirement.	The performance or product measured meets the majority of the intent of the requirement.	The performance or product measured does not meet the majority of the intent of the requirement, but does meet some of the intent.	The performance or product measured does not substantively meet the intent of the requirement.

FERC Order of Violation Severity Levels

The FERC VSL guidelines are presented below, followed by an analysis of whether the VSLs proposed for each requirement in the standard meet the FERC Guidelines for assessing VSLs:

Guideline (1) – Violation Severity Level Assignments Should Not Have the Unintended Consequence of Lowering the Current Level of Compliance

Compare the VSLs to any prior levels of non-compliance and avoid significant changes that may encourage a lower level of compliance than was required when levels of non-compliance were used.

Guideline (2) – Violation Severity Level Assignments Should Ensure Uniformity and Consistency in the Determination of Penalties

A violation of a “binary” type requirement must be a “Severe” VSL.

Do not use ambiguous terms such as “minor” and “significant” to describe noncompliant performance.

Guideline (3) – Violation Severity Level Assignment Should Be Consistent with the Corresponding Requirement

VSLs should not expand on what is required in the requirement.

Guideline (4) – Violation Severity Level Assignment Should Be Based on a Single Violation, Not on a Cumulative Number of Violations

Unless otherwise stated in the requirement, each instance of non-compliance with a requirement is a separate violation. Section 4 of the Sanction Guidelines states that assessing penalties on a per violation per day basis is the “default” for penalty calculations.

Justification for PRC-024-3 VRFs and VSLs

VRF Justification for PRC-024-3, Requirement R1

The VRF did not change from the previously FERC-approved PRC-024-2 Reliability Standard.

VSL Justification for PRC-024-3, Requirement R1

The SDT only made changes to conform the Requirement R1 VSL to the revised Requirement R1 language. The SDT retained the binary structure of the VSL, which is consistent with both the PRC-024-2 and PRC-024-1 VSLs. As a result, the [justification](#) for the Commission-approved PRC-024-1 Requirement R1 VSL supports the justification for the proposed PRC-024-3, Requirement R1 VSL.

VRF Justification for PRC-024-3, Requirement R2

The VRF did not change from the previously FERC-approved PRC-024-2 Reliability Standard.

VSL Justification for PRC-024-3, Requirement R2

The SDT only made changes to conform the Requirement R2 VSL to the revised Requirement R2 language. The SDT retained the binary structure of the VSL, which is consistent with both the PRC-024-2 and PRC-024-1 VSLs. As a result, the [justification](#) for the Commission-approved PRC-024-1 Requirement R2 VSL supports the justification for the proposed PRC-024-3, Requirement R2 VSL.

VRF Justification for PRC-024-3, Requirement R3

The VRF did not change from the previously FERC-approved PRC-024-2 Reliability Standard.

VSL Justification for PRC-024-3, Requirement R3

The SDT only revised the Requirement R4 VSL to remove the word “generator” to encompass all protection as defined in Section 4.2, Facilities. The SDT retained the existing levels of the VSLs, which is consistent with both the PRC-024-2 and PRC-024-1 VSLs. As a result, the [justification](#) for the Commission-approved PRC-024-1 Requirement R3 VSL supports the justification for the proposed PRC-024-3, Requirement R3 VSL.

VRF Justification for PRC-024-3, Requirement R4

The VRF did not change from the previously FERC-approved PRC-024-2 Reliability Standard.

VSL Justification for PRC-024-3, Requirement R4

The SDT only revised the Requirement R4 VSL to remove the word “generator” to encompass all protection as defined in Section 4.2, Facilities. The SDT retained the existing levels of the VSLs, which is consistent with both the PRC-024-2 and PRC-024-1 VSLs. As a result, the

[justification](#) for the Commission-approved PRC-024-1 Requirement R4 VSL supports the justification for the proposed PRC-024-3, Requirement R4 VSL.

VRF Justification for PRC-024-3, Requirement D.A.2.

The SDT made changes to conform the Requirement D.A.2. VSL to the revised Requirement 2 language with the addition of different no trip voltage boundaries based on power plant type as designated by the Planning Coordinator.

VSL Justification for PRC-024-3, Requirement D.A.2.

The SDT only made changes to conform Requirement D.A.2. with the Requirement R2 VSL as well as to add that newly designated strategic power plants have no less than 48 months to set their protection in accordance with the strategic power plant voltage boundaries in Attachment 2a. The SDT retained the binary structure of the VSL, which is consistent with both the PRC-024-2 and PRC-024-1 VSLs. As a result, the [justification](#) for the Commission-approved PRC-024-1 Requirement R2 VSL supports the justification for the proposed PRC-024-3, Requirement D.A.2. VSL.

VRF Justification for PRC-024-3, Requirement D.A.5.

The VRF for Requirement D.A.5. is Medium, given that is unlikely to lead to Bulk Electric System instability, separation, or cascading failures if violated. This is consistent with Requirements R1, R2, and D.A.2.

VSL Justification for PRC-024-3, Requirement D.A.5.

Proposed VSL's incorporate the increments for tardiness methodology. Proposed VSL language does not include ambiguous terms and ensure uniformity and consistency in the determination of penalties based on timeliness of the action specified. Proposed VSL's are based on a single violation and not a cumulative violation methodology.

Standards Announcement

Project 2018-04 Modifications to PRC-024-2

Final Ballot Open through December 13, 2019

[Now Available](#)

The final ballot for **PRC-024-3 – Generator Frequency and Voltage Protection Settings** is open through **8 p.m. Eastern, Friday, December 13, 2019.**

Balloting

In the final ballot, votes are counted by exception. Votes from the previous ballot are automatically carried over in the final ballot. Only members of the applicable ballot pools can cast a vote. Ballot pool members who previously voted have the option to change their vote in the final ballot. Ballot pool members who did not cast a vote during the previous ballot can vote in the final ballot.

Members of the ballot pool associated with this project can log in and submit their votes by accessing the [Standards Balloting and Commenting System \(SBS\)](#). Contact [Wendy Muller](#) regarding issues with the SBS.

- Contact NERC IT support directly at <https://support.nerc.net/> (Monday – Friday, 8 a.m. - 5 p.m. Eastern) for problems regarding accessing the SBS due to a forgotten password, incorrect credential error messages, or system lock-out.
- Passwords expire every **6 months** and must be reset.
- The SBS **is not** supported for use on mobile devices.
- Please be mindful of ballot and comment period closing dates. We ask to **allow at least 48 hours** for NERC support staff to assist with inquiries. Therefore, it is recommended that users try logging into their SBS accounts **prior to the last day** of a comment/ballot period.

Next Steps

The voting results will be posted and announced after the ballot closes. If approved, the standard will be submitted to the Board of Trustees for adoption and then filed with the appropriate regulatory authorities.

Standards Development Process

For more information on the Standards Development Process, refer to the [Standard Processes Manual](#).

For more information or assistance, contact Senior Standards Developers, [Alison Oswald](#) (via email) or at (404) 446-9675 or [Latrice Harkness](#) (via email) or at 404-446-9728.

North American Electric Reliability Corporation
3353 Peachtree Rd, NE
Suite 600, North Tower
Atlanta, GA 30326
404-446-2560 | www.nerc.com

BALLOT RESULTS

Ballot Name: 2018-04 Modifications to PRC-024-2 PRC-024-3 FN 3 ST

Voting Start Date: 12/4/2019 10:07:30 AM

Voting End Date: 12/13/2019 8:00:00 PM

Ballot Type: ST

Ballot Activity: FN

Ballot Series: 3

Total # Votes: 266

Total Ballot Pool: 298

Quorum: 89.26

Quorum Established Date: 12/4/2019 11:24:39 AM

Weighted Segment Value: 82.47

Segment	Ballot Pool	Segment Weight	Affirmative Votes	Affirmative Fraction	Negative Votes w/ Comment	Negative Fraction w/ Comment	Negative Votes w/o Comment	Abstain	No Vote
Segment: 1	73	1	51	0.81	12	0.19	0	4	6
Segment: 2	7	0.6	6	0.6	0	0	0	0	1
Segment: 3	73	1	46	0.821	10	0.179	0	3	14
Segment: 4	18	1	11	0.786	3	0.214	0	1	3
Segment: 5	70	1	47	0.758	15	0.242	0	3	5
Segment: 6	48	1	33	0.786	9	0.214	0	3	3
Segment: 7	0	0	0	0	0	0	0	0	0
Segment: 8	1	0.1	1	0.1	0	0	0	0	0
Segment: 1	1	0.1	1	0.1	0	0	0	0	0

Segment	Ballot Pool	Segment Weight	Affirmative Votes	Affirmative Fraction	Negative Votes w/ Comment	Negative Fraction w/ Comment	Negative Votes w/o Comment	Abstain	No Vote
Segment: 10	7	0.7	6	0.6	1	0.1	0	0	0
Totals:	298	6.5	202	5.36	50	1.14	0	14	32

BALLOT POOL MEMBERS

Show entries

Search:

Segment	Organization	Voter	Designated Proxy	Ballot	NERC Memo
1	AEP - AEP Service Corporation	Dennis Sauriol		Negative	N/A
1	Allete - Minnesota Power, Inc.	Jamie Monette		Affirmative	N/A
1	Ameren - Ameren Services	Eric Scott		Affirmative	N/A
1	APS - Arizona Public Service Co.	Michelle Amarantos		Affirmative	N/A
1	Arizona Electric Power Cooperative, Inc.	John Shaver		Affirmative	N/A
1	Associated Electric Cooperative, Inc.	Mark Riley		Affirmative	N/A
1	Avista - Avista Corporation	Mike Magruder		Affirmative	N/A
1	Balancing Authority of Northern California	Kevin Smith	Joe Tarantino	Affirmative	N/A
1	BC Hydro and Power Authority	Adrian Andreoiu		Affirmative	N/A

Segment	Organization	Voter	Designated Proxy	Ballot	NERC Memo
1	Beaches Energy Services	Don Cuevas	Brandon McCormick	None	N/A
1	Black Hills Corporation	Wes Wingen		Negative	N/A
1	Bonneville Power Administration	Kammy Rogers-Holliday		Affirmative	N/A
1	CenterPoint Energy Houston Electric, LLC	Daniela Hammons		Affirmative	N/A
1	Central Electric Power Cooperative (Missouri)	Michael Bax		Affirmative	N/A
1	City Utilities of Springfield, Missouri	Michael Buyce		Affirmative	N/A
1	CMS Energy - Consumers Energy Company	Donald Lynd		Negative	N/A
1	Colorado Springs Utilities	Mike Braunstein		Affirmative	N/A
1	Con Ed - Consolidated Edison Co. of New York	Dermot Smyth		Affirmative	N/A
1	Dairyland Power Cooperative	Renee Leidel		Abstain	N/A
1	Dominion - Dominion Virginia Power	Candace Marshall		Negative	N/A
1	Duke Energy	Laura Lee		Negative	N/A
1	Edison International - Southern California Edison Company	Ayman Samaan		Affirmative	N/A
1	Entergy - Entergy Services, Inc.	Oliver Burke		Negative	N/A
1	Exelon	Daniel Gacek		Abstain	N/A
1	FirstEnergy - FirstEnergy Corporation	Julie Severino		Negative	N/A
1	Gainesville Regional Utilities	David Owens	Brandon McCormick	None	N/A
1	Georgia Transmission Corporation	Greg Davis		Affirmative	N/A

Segment	Organization	Voter	Designated Proxy	Ballot	NERC Memo
1	Glencoe Light and Power Commission	Terry Volkmann		Affirmative	N/A
1	Great Plains Energy - Kansas City Power and Light Co.	James McBee		Affirmative	N/A
1	Great River Energy	Gordon Pietsch		Affirmative	N/A
1	Hydro-Qu?bec TransEnergie	Nicolas Turcotte		Affirmative	N/A
1	Imperial Irrigation District	Jesus Sammy Alcaraz		Abstain	N/A
1	Lakeland Electric	Larry Watt		Negative	N/A
1	Lincoln Electric System	Danny Pudenz		Affirmative	N/A
1	Los Angeles Department of Water and Power	faranak sarbaz		None	N/A
1	Lower Colorado River Authority	Trey Melcher		None	N/A
1	M and A Electric Power Cooperative	William Price		Affirmative	N/A
1	Manitoba Hydro	Bruce Reimer		Affirmative	N/A
1	Muscatine Power and Water	Andy Kurriger		Affirmative	N/A
1	N.W. Electric Power Cooperative, Inc.	Mark Ramsey		Affirmative	N/A
1	National Grid USA	Michael Jones		Affirmative	N/A
1	Nebraska Public Power District	Jamison Cawley		Affirmative	N/A
1	New York Power Authority	Salvatore Spagnolo		Affirmative	N/A
1	NextEra Energy - Florida Power and Light Co.	Mike ONeil		Affirmative	N/A
1	NiSource - Northern Indiana Public Service Co.	Steve Toosevich		Affirmative	N/A

Segment	Organization	Voter	Designated Proxy	Ballot	NERC Memo
1	Northeast Missouri Electric Power Cooperative	Kevin White		Affirmative	N/A
1	OGE Energy - Oklahoma Gas and Electric Co.	Terri Pyle		Affirmative	N/A
1	Oncor Electric Delivery	Lee Maurer	Eric Shaw	None	N/A
1	Orlando Utilities Commission	Aaron Staley		Affirmative	N/A
1	Platte River Power Authority	Matt Thompson		Affirmative	N/A
1	PPL Electric Utilities Corporation	Michelle Longo		Affirmative	N/A
1	PSEG - Public Service Electric and Gas Co.	Sean Cavote		Affirmative	N/A
1	Public Utility District No. 1 of Chelan County	Ginette Lacasse		Affirmative	N/A
1	Public Utility District No. 1 of Snohomish County	Long Duong		Affirmative	N/A
1	Puget Sound Energy, Inc.	Theresa Rakowsky		Affirmative	N/A
1	Sacramento Municipal Utility District	Arthur Starkovich	Joe Tarantino	Affirmative	N/A
1	Salt River Project	Chris Hofmann		Affirmative	N/A
1	Santee Cooper	Chris Wagner		Affirmative	N/A
1	SaskPower	Wayne Guttormson		Affirmative	N/A
1	Seattle City Light	Pawel Krupa		Affirmative	N/A
1	Seminole Electric Cooperative, Inc.	Bret Galbraith		Negative	N/A
1	Sempra - San Diego Gas and Electric	Mo Derbas		Affirmative	N/A
1	Sho-Me Power Electric Cooperative	Peter Dawson		Affirmative	N/A

Segment	Organization	Voter	Designated Proxy	Ballot	NERC Memo
1	Southern Company - Southern Company Services, Inc.	Matt Carden		Negative	N/A
1	Tacoma Public Utilities (Tacoma, WA)	John Merrell		Affirmative	N/A
1	Tallahassee Electric (City of Tallahassee, FL)	Scott Langston		Affirmative	N/A
1	Tennessee Valley Authority	Gabe Kurtz		Negative	N/A
1	Tri-State G and T Association, Inc.	Kjersti Drott		None	N/A
1	U.S. Bureau of Reclamation	Richard Jackson		Negative	N/A
1	Unisource - Tucson Electric Power Co.	John Tolo		Affirmative	N/A
1	Westar Energy	Allen Klassen	Douglas Webb	Affirmative	N/A
1	Western Area Power Administration	sean erickson		Abstain	N/A
1	Xcel Energy, Inc.	Dean Schiro		Affirmative	N/A
2	California ISO	Jamie Johnson		Affirmative	N/A
2	Electric Reliability Council of Texas, Inc.	Brandon Gleason		Affirmative	N/A
2	Independent Electricity System Operator	Leonard Kula		Affirmative	N/A
2	Midcontinent ISO, Inc.	Bobbi Welch		None	N/A
2	New York Independent System Operator	Gregory Campoli		Affirmative	N/A
2	PJM Interconnection, L.L.C.	Mark Holman		Affirmative	N/A
2	Southwest Power Pool, Inc. (RTO)	Charles Yeung		Affirmative	N/A
3	AEP	Kent Feliks		Negative	N/A

Segment	Organization	Voter	Designated Proxy	Ballot	NERC Memo
3	AES - Indianapolis Power and Light Co.	Colleen Campbell		Affirmative	N/A
3	Ameren - Ameren Services	David Jendras		Affirmative	N/A
3	APS - Arizona Public Service Co.	Vivian Moser		Affirmative	N/A
3	Associated Electric Cooperative, Inc.	Todd Bennett		Affirmative	N/A
3	Austin Energy	W. Dwayne Preston		Affirmative	N/A
3	Avista - Avista Corporation	Scott Kinney		Affirmative	N/A
3	BC Hydro and Power Authority	Hootan Jarollahi		Affirmative	N/A
3	Beaches Energy Services	Steven Lancaster	Brandon McCormick	None	N/A
3	Berkshire Hathaway Energy - MidAmerican Energy Co.	Darnez Gresham		Affirmative	N/A
3	Black Hills Corporation	Eric Egge		Negative	N/A
3	Bonneville Power Administration	Ken Lanehome		Affirmative	N/A
3	Central Electric Power Cooperative (Missouri)	Adam Weber		Affirmative	N/A
3	City Utilities of Springfield, Missouri	Scott Williams		Affirmative	N/A
3	CMS Energy - Consumers Energy Company	Karl Blaszkowski		Negative	N/A
3	Colorado Springs Utilities	Hillary Dobson		Affirmative	N/A
3	Con Ed - Consolidated Edison Co. of New York	Peter Yost		Affirmative	N/A
3	Cowlitz County PUD	Russell Noble		Affirmative	N/A
3	CPS Energy	James Grimshaw		None	N/A

Segment	Organization	Voter	Designated Proxy	Ballot	NERC Memo
3	Dominion - Dominion Resources, Inc.	Connie Lowe		Negative	N/A
3	DTE Energy - Detroit Edison Company	Karie Barczak		Negative	N/A
3	Duke Energy	Lee Schuster		Negative	N/A
3	Edison International - Southern California Edison Company	Romel Aquino		Affirmative	N/A
3	Eversource Energy	Sharon Flannery		None	N/A
3	Exelon	Kinte Whitehead		Abstain	N/A
3	FirstEnergy - FirstEnergy Corporation	Aaron Ghodooshim		Negative	N/A
3	Florida Municipal Power Agency	Dale Ray		Negative	N/A
3	Gainesville Regional Utilities	Darko Kovac	Brandon McCormick	None	N/A
3	Georgia System Operations Corporation	Scott McGough		Affirmative	N/A
3	Great Plains Energy - Kansas City Power and Light Co.	John Carlson		Affirmative	N/A
3	Great River Energy	Brian Glover		Affirmative	N/A
3	JEA	Garry Baker		None	N/A
3	KAMO Electric Cooperative	Tony Gott		Affirmative	N/A
3	Lakeland Electric	Patricia Boody		None	N/A
3	Lincoln Electric System	Jason Fortik		Affirmative	N/A
3	Los Angeles Department of Water and Power	Tony Skourtas		Affirmative	N/A
3	M and A Electric Power Cooperative	Stephen Pogue		Affirmative	N/A
3	Manitoba Hydro	Karim Abdel-Hadi		Affirmative	N/A

Segment	Organization	Voter	Designated Proxy	Ballot	NERC Memo
3	MGE Energy - Madison Gas and Electric Co.	Ronald Bauer		None	N/A
3	Muscatine Power and Water	Seth Shoemaker		Affirmative	N/A
3	National Grid USA	Brian Shanahan		Affirmative	N/A
3	Nebraska Public Power District	Tony Eddleman		Affirmative	N/A
3	New York Power Authority	David Rivera		Affirmative	N/A
3	NiSource - Northern Indiana Public Service Co.	Dmitriy Bazylyuk		Affirmative	N/A
3	North Carolina Electric Membership Corporation	doug white		None	N/A
3	Northeast Missouri Electric Power Cooperative	Skyler Wiegmann		Affirmative	N/A
3	NW Electric Power Cooperative, Inc.	John Stickley		Affirmative	N/A
3	Ocala Utility Services	Neville Bowen		Abstain	N/A
3	OGE Energy - Oklahoma Gas and Electric Co.	Donald Hargrove		Affirmative	N/A
3	Omaha Public Power District	Aaron Smith		Affirmative	N/A
3	Owensboro Municipal Utilities	Thomas Lyons		Abstain	N/A
3	Platte River Power Authority	Wade Kiess		Affirmative	N/A
3	PNM Resources - Public Service Company of New Mexico	Trevor Tidwell		None	N/A
3	Portland General Electric Co.	Dan Zollner		Affirmative	N/A

Segment	Organization	Voter	Designated Proxy	Ballot	NERC Memo
3	PPL - Louisville Gas and Electric Co.	James Frank		Affirmative	N/A
3	PSEG - Public Service Electric and Gas Co.	James Meyer		None	N/A
3	Public Utility District No. 1 of Chelan County	Joyce Gundry		Affirmative	N/A
3	Puget Sound Energy, Inc.	Tim Womack		Affirmative	N/A
3	Sacramento Municipal Utility District	Nicole Looney	Joe Tarantino	Affirmative	N/A
3	Salt River Project	Zack Heim		None	N/A
3	Santee Cooper	James Poston		Affirmative	N/A
3	Seminole Electric Cooperative, Inc.	Michael Lee		None	N/A
3	Sempra - San Diego Gas and Electric	Bridget Silvia		Affirmative	N/A
3	Sho-Me Power Electric Cooperative	Jarrod Murdaugh		Affirmative	N/A
3	Silicon Valley Power - City of Santa Clara	Val Ridad		None	N/A
3	Snohomish County PUD No. 1	Holly Chaney		Affirmative	N/A
3	Southern Company - Alabama Power Company	Joel Dembowski		Negative	N/A
3	Tacoma Public Utilities (Tacoma, WA)	Marc Donaldson		Affirmative	N/A
3	TECO - Tampa Electric Co.	Ronald Donahey		None	N/A
3	Tennessee Valley Authority	Ian Grant		Negative	N/A
3	WEC Energy Group, Inc.	Thomas Breene		Affirmative	N/A
3	Westar Energy	Bryan Taggart	Douglas Webb	Affirmative	N/A
3	Xcel Energy, Inc.	Joel Limoges		Affirmative	N/A

Segment	Organization	Voter	Designated Proxy	Ballot	NERC Memo
4	Alliant Energy Corporation Services, Inc.	Larry Heckert		Affirmative	N/A
4	Austin Energy	Jun Hua		None	N/A
4	City Utilities of Springfield, Missouri	John Allen		Affirmative	N/A
4	CMS Energy - Consumers Energy Company	Dwayne Parker		Negative	N/A
4	FirstEnergy - FirstEnergy Corporation	Mark Garza		Negative	N/A
4	Florida Municipal Power Agency	Carol Chinn		Negative	N/A
4	Georgia System Operations Corporation	Andrea Barclay		Affirmative	N/A
4	Indiana Municipal Power Agency	Jack Alvey	Scott Berry	Abstain	N/A
4	Keys Energy Services	Nick Batty	Brandon McCormick	None	N/A
4	MGE Energy - Madison Gas and Electric Co.	Joseph DePoorter		Affirmative	N/A
4	North Carolina Electric Membership Corporation	Richard McCall	Kagen DelRio	Affirmative	N/A
4	Oklahoma Municipal Power Authority	Ashley Stringer		None	N/A
4	Public Utility District No. 1 of Snohomish County	John Martinsen		Affirmative	N/A
4	Public Utility District No. 2 of Grant County, Washington	Karla Weaver		Affirmative	N/A
4	Sacramento Municipal Utility District	Beth Tincher	Joe Tarantino	Affirmative	N/A
4	Seattle City Light	Hao Li		Affirmative	N/A

Segment	Organization	Voter	Designated Proxy	Ballot	NERC Memo
4	Tacoma Public Utilities (Tacoma, WA)	Hien Ho		Affirmative	N/A
4	Utility Services, Inc.	Brian Evans-Mongeon		Affirmative	N/A
5	AEP	Thomas Foltz		Negative	N/A
5	AES - AES Corporation	Leo Bernier		None	N/A
5	Ameren - Ameren Missouri	Sam Dwyer		Affirmative	N/A
5	APS - Arizona Public Service Co.	Kelsi Rigby		Affirmative	N/A
5	Associated Electric Cooperative, Inc.	Brad Haralson		Affirmative	N/A
5	Austin Energy	Lisa Martin		Affirmative	N/A
5	Avista - Avista Corporation	Glen Farmer		Affirmative	N/A
5	Basin Electric Power Cooperative	Mike Kraft		None	N/A
5	Berkshire Hathaway - NV Energy	Kevin Salsbury		Affirmative	N/A
5	Black Hills Corporation	George Tatar		Negative	N/A
5	Bonneville Power Administration	Scott Winner		Affirmative	N/A
5	Brazos Electric Power Cooperative, Inc.	Shari Heino		Affirmative	N/A
5	Choctaw Generation Limited Partnership, LLLP	Rob Watson		Negative	N/A
5	City of Independence, Power and Light Department	Jim Nail		Affirmative	N/A
5	City Water, Light and Power of Springfield, IL	Rick Meadows		None	N/A

Segment	Organization	Voter	Designated Proxy	Ballot	NERC Memo
5	CMS Energy - Consumers Energy Company	David Greyerbiehl		Negative	N/A
5	Con Ed - Consolidated Edison Co. of New York	William Winters	Daniel Valle	Affirmative	N/A
5	Cowlitz County PUD	Deanna Carlson		Affirmative	N/A
5	Dairyland Power Cooperative	Tommy Drea		Affirmative	N/A
5	Dominion - Dominion Resources, Inc.	Rachel Snead		Negative	N/A
5	DTE Energy - Detroit Edison Company	Adrian Raducea		Negative	N/A
5	Duke Energy	Dale Goodwine		Negative	N/A
5	Edison International - Southern California Edison Company	Neil Shockey		Affirmative	N/A
5	Exelon	Cynthia Lee		Abstain	N/A
5	FirstEnergy - FirstEnergy Solutions	Robert Loy		Negative	N/A
5	Florida Municipal Power Agency	Chris Gowder		Negative	N/A
5	Great Plains Energy - Kansas City Power and Light Co.	Marcus Moor		Affirmative	N/A
5	Great River Energy	Preston Walsh		Affirmative	N/A
5	Herb Schrayshuen	Herb Schrayshuen		Affirmative	N/A
5	Imperial Irrigation District	Tino Zaragoza		Abstain	N/A
5	Lakeland Electric	Jim Howard		Negative	N/A
5	Lincoln Electric System	Kayleigh Wilkerson		Affirmative	N/A
5	Los Angeles Department of Water and Power	Glenn Barry		Affirmative	N/A

Segment	Organization	Voter	Designated Proxy	Ballot	NERC Memo
5	Lower Colorado River Authority	Teresa Cantwell		Affirmative	N/A
5	Manitoba Hydro	Yuguang Xiao		Affirmative	N/A
5	Massachusetts Municipal Wholesale Electric Company	Anthony Stevens		None	N/A
5	MGE Energy - Madison Gas and Electric Co.	Steven Schultz		None	N/A
5	National Grid USA	Elizabeth Spivak		Affirmative	N/A
5	NaturEner USA, LLC	Eric Smith		Affirmative	N/A
5	NB Power Corporation	Laura McLeod		Affirmative	N/A
5	New York Power Authority	Shivaz Chopra		Affirmative	N/A
5	NextEra Energy	Allen Schriver		Affirmative	N/A
5	NiSource - Northern Indiana Public Service Co.	Kathryn Tackett		Affirmative	N/A
5	North Carolina Electric Membership Corporation	John Cook	Kagen DelRio	Affirmative	N/A
5	Northern California Power Agency	Marty Hostler		Negative	N/A
5	OGE Energy - Oklahoma Gas and Electric Co.	Patrick Wells		Affirmative	N/A
5	Oglethorpe Power Corporation	Donna Johnson		Affirmative	N/A
5	Omaha Public Power District	Mahmood Safi		Affirmative	N/A
5	Ontario Power Generation Inc.	Constantin Chitescu		Affirmative	N/A
5	Platte River Power Authority	Tyson Archie		Affirmative	N/A
5	PPL - Louisville Gas and Electric Co.	JULIE HOSTRANDER		Affirmative	N/A

Segment	Organization	Voter	Designated Proxy	Ballot	NERC Memo
5	PSEG - PSEG Fossil LLC	Tim Kucey		Affirmative	N/A
5	Public Utility District No. 1 of Chelan County	Meaghan Connell		Affirmative	N/A
5	Public Utility District No. 1 of Snohomish County	Sam Nietfeld		Affirmative	N/A
5	Puget Sound Energy, Inc.	Lynn Murphy		Affirmative	N/A
5	Sacramento Municipal Utility District	Susan Oto	Joe Tarantino	Affirmative	N/A
5	Salt River Project	Kevin Nielsen		Affirmative	N/A
5	Santee Cooper	Tommy Curtis		Affirmative	N/A
5	Seattle City Light	Faz Kasraie		Affirmative	N/A
5	Seminole Electric Cooperative, Inc.	David Weber		Negative	N/A
5	Sempra - San Diego Gas and Electric	Jennifer Wright		Affirmative	N/A
5	Southern Company - Southern Company Generation	William D. Shultz		Negative	N/A
5	SunPower	Bradley Collard		Abstain	N/A
5	Tacoma Public Utilities (Tacoma, WA)	Ozan Ferrin		Affirmative	N/A
5	Talen Generation, LLC	Donald Lock		Negative	N/A
5	U.S. Bureau of Reclamation	Wendy Center		Negative	N/A
5	Vistra Energy	Dan Roethemeyer		Affirmative	N/A
5	WEC Energy Group, Inc.	Janet OBrien		Affirmative	N/A
5	Westar Energy	Derek Brown	Douglas Webb	Affirmative	N/A
5	Xcel Energy, Inc.	Gerry Huitt	Amy Casuscelli	Affirmative	N/A
6	AEP - AEP Marketing	Yee Chou		Negative	N/A

Segment	Organization	Voter	Designated Proxy	Ballot	NERC Memo
6	Ameren - Ameren Services	Robert Quinlivan		Affirmative	N/A
6	APS - Arizona Public Service Co.	Chinedu Ochonogor		Affirmative	N/A
6	Associated Electric Cooperative, Inc.	Brian Ackermann		None	N/A
6	Berkshire Hathaway - PacifiCorp	Sandra Shaffer		Affirmative	N/A
6	Black Hills Corporation	Eric Scherr		Affirmative	N/A
6	Bonneville Power Administration	Andrew Meyers		Affirmative	N/A
6	Cleco Corporation	Robert Hirschak	Louis Guidry	Affirmative	N/A
6	Con Ed - Consolidated Edison Co. of New York	Christopher Overberg		Affirmative	N/A
6	Dominion - Dominion Resources, Inc.	Sean Bodkin		Negative	N/A
6	Duke Energy	Greg Cecil		Negative	N/A
6	Edison International - Southern California Edison Company	Kenya Streeter		Affirmative	N/A
6	Exelon	Becky Webb		Abstain	N/A
6	FirstEnergy - FirstEnergy Solutions	Ann Carey		Negative	N/A
6	Florida Municipal Power Agency	Richard Montgomery		Negative	N/A
6	Florida Municipal Power Pool	Tom Reedy	Brandon McCormick	None	N/A
6	Great Plains Energy - Kansas City Power and Light Co.	Jennifer Flandermeyer		Affirmative	N/A
6	Great River Energy	Donna Stephenson	Michael Brytowski	Affirmative	N/A
6	Lakeland Electric	Paul Shipp		Negative	N/A

Segment	Organization	Voter	Designated Proxy	Ballot	NERC Memo
6	Lincoln Electric System	Eric Ruskamp		Affirmative	N/A
6	Los Angeles Department of Water and Power	Anton Vu		Affirmative	N/A
6	Manitoba Hydro	Blair Mukanik		Affirmative	N/A
6	MGE Energy - Madison Gas and Electric Co.	Robert Thorson		None	N/A
6	Muscatine Power and Water	Nick Burns		Affirmative	N/A
6	New York Power Authority	Erick Barrios	Shelly Dineen	Affirmative	N/A
6	NextEra Energy - Florida Power and Light Co.	Justin Welty		Affirmative	N/A
6	NiSource - Northern Indiana Public Service Co.	Joe O'Brien		Affirmative	N/A
6	Northern California Power Agency	Dennis Sismaet		Abstain	N/A
6	OGE Energy - Oklahoma Gas and Electric Co.	Sing Tay		Affirmative	N/A
6	Platte River Power Authority	Sabrina Martz		Affirmative	N/A
6	Portland General Electric Co.	Daniel Mason		Affirmative	N/A
6	Powerex Corporation	Gordon Dobson-Mack		Affirmative	N/A
6	PPL - Louisville Gas and Electric Co.	Linn Oelker		Affirmative	N/A
6	PSEG - PSEG Energy Resources and Trade LLC	Luigi Beretta		Affirmative	N/A
6	Public Utility District No. 1 of Chelan County	Davis Jelusich		Affirmative	N/A

Segment	Organization	Voter	Designated Proxy	Ballot	NERC Memo
6	Public Utility District No. 2 of Grant County, Washington	LeRoy Patterson		Affirmative	N/A
6	Sacramento Municipal Utility District	Jamie Cutlip	Joe Tarantino	Affirmative	N/A
6	Santee Cooper	Michael Brown		Affirmative	N/A
6	Seattle City Light	Charles Freeman		Affirmative	N/A
6	Seminole Electric Cooperative, Inc.	Michael Lee		Abstain	N/A
6	Snohomish County PUD No. 1	John Liang		Affirmative	N/A
6	Southern Company - Southern Company Generation	Ron Carlsen		Negative	N/A
6	Tacoma Public Utilities (Tacoma, WA)	Terry Gifford		Affirmative	N/A
6	Talen Energy Marketing, LLC	Jennifer Hohenshilt		Negative	N/A
6	Tennessee Valley Authority	Marjorie Parsons		Negative	N/A
6	WEC Energy Group, Inc.	David Hathaway		Affirmative	N/A
6	Westar Energy	Grant Wilkerson	Douglas Webb	Affirmative	N/A
6	Xcel Energy, Inc.	Carrie Dixon	Amy Casuscelli	Affirmative	N/A
8	David Kiguel	David Kiguel		Affirmative	N/A
9	Commonwealth of Massachusetts Department of Public Utilities	Donald Nelson		Affirmative	N/A
10	Midwest Reliability Organization	Russel Mountjoy		Affirmative	N/A
10	New York State Reliability Council	ALAN ADAMSON		Affirmative	N/A
10	Northeast Power Coordinating Council	Guy V. Zito		Affirmative	N/A

Segment	Organization	Voter	Designated Proxy	Ballot	NERC Memo
10	ReliabilityFirst	Anthony Jablonski		Affirmative	N/A
10	SERC Reliability Corporation	Dave Krueger		Affirmative	N/A
10	Texas Reliability Entity, Inc.	Rachel Coyne		Negative	N/A
10	Western Electricity Coordinating Council	Steven Rueckert		Affirmative	N/A

Showing 1 to 298 of 298 entries

Previous Next

Exhibit F

PRC-024-2 Gaps Whitepaper

PRC-024-2 Gaps Whitepaper

NERC Inverter-Based Resource Performance Task Force (IRPTF)

Purpose

The NERC Inverter-Based Resource Performance Task Force (IRPTF)¹ scope document² includes a deliverable on “recommendations on inverter-based resource performance and any modifications to NERC Reliability Standards related to the control and dynamic performance of these resources during abnormal grid conditions.” The whitepaper presented here details the findings of the IRPTF as a result of investigations related to this deliverable. Specifically, the whitepaper details potential gaps and needed clarifications in PRC-024-2: *Generator Frequency and Voltage Protective Relay Settings*. There is some overlap between the findings of this whitepaper and the Integration of Variable Generation Task Force (IVGTF) Summary and Recommendations of 12 Tasks³ which was published in 2015.

Background

Multiple grid disturbances in the Western Interconnection have highlighted the potential risk of fault-induced solar photovoltaic (PV) tripping. While these disturbances have been prominent in the West, the underlying issues are systemic in the solar PV fleet across interconnections.

- On August 16, 2016, the Blue Cut Fire disturbance resulted in approximately 1200 MW of solar photovoltaic (PV) resources tripping offline or momentarily ceasing output in Southern California. NERC and WECC created an ad hoc task force to investigate causes of the solar PV tripping, develop a disturbance report⁴, initiate remedial actions, and provide recommendations for future work.
- On October 9, 2017, the Canyon 2 Fire disturbance in Southern California resulted in approximately 900 MW of solar PV tripping or momentarily ceasing output. This disturbance involved voltage-related tripping, and highlighted an unintended interpretation of PRC-024-2. NERC and WECC developed a disturbance report⁵, which included key findings and recommendations for mitigating action.

Both disturbance reports have led to NERC Alerts to gather necessary data to understand the extent of the conditions identified as well as to recommend mitigating actions to these potential reliability risks to

¹ NERC Inverter-Based Resource Performance Task Force (IRPTF) webpage. Available: <https://www.nerc.com/comm/PC/Pages/Inverter-Based-Resource-Performance-Task-Force.aspx>.

² IRPTF Scope Document. Available:

https://www.nerc.com/comm/PC/InverterBased%20Resource%20Performance%20Task%20Force%20IRPT/IRPTF_Scope_20170619.pdf.

³ IVGTF Report. Available:

https://www.nerc.com/comm/PC/Integration%20of%20Variable%20Generation%20Task%20Force%20I1/IVGTF%20Summary%20and%20Recommendation%20Report_Final.pdf

⁴ Blue Cut Fire Disturbance Report. Available:

http://www.nerc.com/pa/rrm/ea/1200_MW_Fault_Induced_Solar_Photovoltaic_Resource_/1200_MW_Fault_Induced_Solar_Photovoltaic_Resource_Interruption_Final.pdf.

⁵ Canyon 2 Fire Disturbance Report. Available:

<https://www.nerc.com/pa/rrm/ea/Pages/October-9-2017-Canyon-2-Fire-Disturbance-Report.aspx>.

the Bulk Electric System (BES). Following completion of the Blue Cut Fire disturbance analysis, NERC formed the NERC IRPTF to continue focusing on inverter-based resource performance during steady-state

PRC-024-2 Issues

FERC approved the NERC Reliability Standard PRC-024-2: *Generator Frequency and Voltage Protective Relay Settings* in May 2015 and the standard went into effect on July 1, 2016. The original version of the standard, PRC-024-1, was approved by FERC in 2014. The purpose of PRC-024-2 is to “ensure Generator Owners set their generator protective relays such that generating units remain connected during defined frequency and voltage excursions.”⁶ The primary purpose of the revision was not to ensure the protection of generation resources, but rather to aid BES stability without jeopardizing the generation resources. Hence, the standard includes requirements that generator protective relays be set such that they do not trip the applicable generating unit(s) when operating within specified frequency and voltage “no trip zones”.

Event analysis for both the Blue Cut Fire and Canyon 2 Fire disturbances revealed that misinterpretation of the requirements of PRC-024-2 led to the intentional and unnecessary tripping of solar PV resources during these events. In addition to identifying the need to provide clarity around the requirements in PRC-024-2, the IRPTF also found errors within the standard. Based on these findings, the IRPTF has concluded that the following issues in PRC-024-2 should be addressed:

- The region outside the “No-Trip” zone of the PRC-024-2 ride-through curves should be clearly marked as a “May-Trip” zone so it is not incorrectly interpreted as a “Must-Trip” zone. The preferred behavior is for the generators to ride-through disturbances to the greatest extent possible.
- There is inconsistency between the Curve Data Point tables and the Off Nominal Frequency Capability Curves as the table identifies “instantaneous” trip points while the time axis of the curve starts at 100 ms.
- There is confusion in point #5 of the Curve Details section of the Voltage Ride-Through Curve Clarifications regarding crest and RMS voltage relationship.
- There is confusion regarding the inclusion of the four second cumulative timer functionality, as well as when the timer starts, stops, and resets.
- There is confusion regarding footnote 1 and the applicability of inverter control systems to the standard.

“Must-Trip” versus “May-Trip” Interpretation

PRC-024-2 specifies a “No-Trip” area for voltage and frequency excursions, as measured at the point of interconnection to the BES. According to the Blue Cut Fire Disturbance Analysis Report solar development owners and inverter manufacturers have misinterpreted the area outside of the “No-Trip” curve as a

⁶ NERC Reliability Standard PRC-024-2 – Generator Frequency and Voltage Protective Relay Settings. Available: <https://www.nerc.com/ layouts/15/PrintStandard.aspx?standardnumber=PRC-024-2&title=Generator%20Frequency%20and%20Voltage%20Protective%20Relay%20Settings&jurisdiction=United States>.

“Must-Trip” requirement. This is possibly due to the use of the term “instantaneous trip” in the tables following the voltage and frequency ride-through curves.

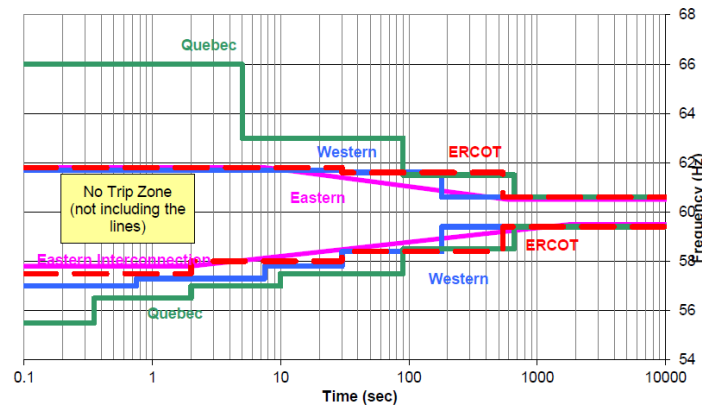

Figure 1: PRC-024-2 Frequency Ride-Through Curve

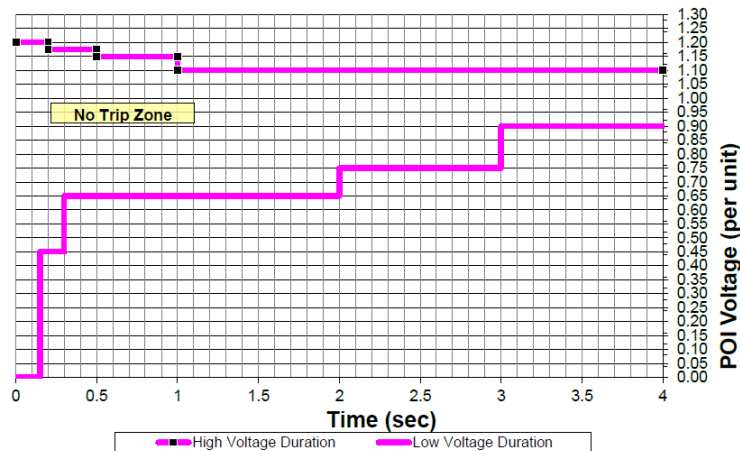

Figure 2: PRC-024-2 Voltage Ride-Through Curve

PRC-024-2 footnote 1 clarifies that Generator Owners are not required to have frequency or voltage protective relays. However, most inverter control systems have built-in protective controls for which the Generator Owners must provide settings. The Canyon 2 Fire Disturbance Report⁷ found that all of the owners and manufacturers of the affected inverters had used the PRC-024-2 voltage ride-through curve to set the voltage protective settings. Several of the data request responses indicated that the “May- Trip” zone was being interpreted as a “Must-Trip” zone. Hence, despite the recognition in the Blue Cut Fire Disturbance Analysis Report of this misinterpretation, the industry was still setting the voltage protective settings according to the standard ride-through curve rather than on actual equipment voltage limitations, approximately 14 months after the Blue Cut Fire Event. Further, these set points were incorrectly applied at the inverter terminals, which are subject to wider voltage excursions than at the

⁷ Canyon 2 Fire Disturbance Report. Available: <https://www.nerc.com/pa/rrm/ea/Pages/October-9-2017-Canyon-2-Fire-Disturbance-Report.aspx>.

point of interconnection during transmission system disturbances due to voltage drop or rise across the collection system during the disturbance.

However, the intent of the PRC-024-2 voltage ride-through requirement is to define the minimum and maximum voltage conditions where generating resources may trip from protective relaying for voltage excursions. The region outside the “No-Trip” zone should be interpreted as a “May-Trip” zone and not a “Must-Trip” zone. Inverter settings should be determined based on equipment limitations and should be set to ride-through to the greatest extent possible. This helps support bulk power system (BPS) reliability during and following grid events such as faults.

Similarly, frequency trip settings for generation resources should be set as wide as possible while still ensuring equipment protection and personnel safety to support BPS reliability. This aligns with the intent of PRC- 024-2. One possible solution could be to change the requirement such that relay settings be set based on equipment limitations but no narrower than the “No-Trip” zones.

Inconsistency between Ride-Through Curves and Tables

PRC-024-2 Attachments 1 and 2 include graphics showing the off-nominal frequency capability curve and the voltage ride-through curve, respectively, with curve data point tables describing the curves in tabular form. The curves and tables define the frequency and voltage protective relay setting minimum performance requirements. Each table contains a value for which a generation resource is allowed to instantaneously trip, essentially describing at what frequency or voltage a generator is no longer required to stay connected to the system.

The task force that analyzed the Blue Cut Fire event found that, “[a] significant amount of solar PV resources disconnected due to a perceived system frequency below 57 Hz. This perceived frequency was due to the Phase Locked Loop logic indicating a near instantaneous frequency during the transient/distorted waveform period as less than 57 Hz. The solar development owner and inverter manufacturer interpreted outside of the PRC-024-2 no- trip curve area as a must-trip area. The frequency table in PRC-024-2 for the Western Interconnection indicates instantaneous trip for frequency equal to or less than 57 Hz. Therefore, the inverters were set to trip instantaneously upon seeing a frequency of 57 Hz.”

However, in generation resource control systems, frequency is calculated over a window of time. Instantaneously derived frequency should not be used for protection. Frequency calculation methods use various types of time windows and filtering methods in order to accurately calculate grid frequency. Typically, these methods use a sliding window with a window width on the order of 100 ms (6 cycles). Thus, a delay would occur even if the protective relay algorithm had no intentional time delay. This measurement interval should be reflected in the standard.

Further, the Off Nominal Frequency Capability Curve of PRC-024-2 is a logarithmic graph that starts at time $t=0.1$ seconds. Thus, the Curve Data Point table “Instantaneous trip” value is inconsistent with the graphic.

Voltage Ride-Through Curve Clarification Error

Point #5 in the Curve Details section of the “Voltage Ride-Through Curve Clarifications” of PRC-024-2 states, “voltages in the curve assume minimum fundamental frequency phase to ground or phase to phase voltage for the low duration curve and the greater of maximum RMS (Root Mean Square) or crest phase to phase voltage for the high voltage duration curve.” Numerically, the crest value is always greater than the RMS value of a periodic waveform, so there is ambiguity and technical concern on how this is applied. Without addressing this, there may be reliability issues, as identified in the Canyon 2 Fire Disturbance Analysis Report.

Any voltage measured and compared with the PRC-024-2 voltage ride-through curve should be a well-filtered, fundamental frequency component of the voltage waveform. This filters out spurious voltage spikes caused by switching actions on the BPS. Voltage protective relays should not operate at the voltage levels specified in the voltage ride-through curve (e.g., 1.2 pu) using instantaneously sampled values, although it is reasonable for a generator resource to trip for instantaneous voltage spikes above equipment limitations if they can be properly detected. The other issue with this clarification is that the overvoltage component of the clarification states “the greater of maximum RMS or crest phase-to-phase voltage”. Numerically, the crest value is always greater than the RMS value of a periodic waveform, so there is ambiguity and technical concern on how this is applied.

Further, PRC-024-2 clarifies that the low voltage duration curve is based on either phase-to-ground or phase-to-phase voltage, the high voltage duration curve is only based on phase-to-phase voltage. It is not clear why phase-to-ground voltage should not also be considered for high voltage ride-through. Without addressing these, there may be reliability issues, as identified in the Canyon 2 Fire Disturbance Analysis Report.

Confusion in Cumulative Timer Start and Stop Time

The PRC-024-2 voltage ride-through curve ends at four seconds, and the curve uses a cumulative time duration for the “No-Trip” zone. Protective relays must be set to accommodate the cumulative nature of ride-through curves. Under the current version of PRC-024-2, it is not clear at what points the cumulative values reset or what are the starting and ending criteria. This cumulative aspect is also applied in the Volts/Hertz relay protection that covers both synchronous generation resources and generator step up transformers and needs to have clarification for the action to trip or reset.

Footnote 1 Applicability Confusion

Footnote 1 is intended to clarify that Generator Owners are not required to have frequency or voltage protective relaying, thus the requirements only apply if they do have such relays. The footnote contains a parenthetical with an “including but not limited to” statement that is intended to further clarify and provide examples of the types of relays that are applicable. The list contained within the parenthetical includes “protective functions within control systems that directly trip or provide tripping signals to the generator resource based on frequency or voltage inputs.”

As noted in the Blue Cut Fire disturbance report, “PRC-024-2 uses language that is more common for conventional synchronous rotating ac generators with traditional protective relays.” Because of the language in the bulk of the standard, there is confusion regarding whether the parenthetical list in the

footnote is intended to make inverter controls applicable to the requirements of the standard, and if so, what operating modes or functions are considered “tripping” the generating resource. Further, if PRC-024-2 applies to inverter controls, do the requirements apply to individual inverters or to the generation resource as a whole? As an example, if 50% of inverters within a generation resource trip for a grid disturbance within the “No-Trip” zone of the ride-through curves, but the generation resource does not trip at a plant level, does that meet the intent of the requirements? These points of confusion should be addressed.

Exhibit G
Standard Drafting Team Roster

Drafting Team Roster

Project 2018-04 Modifications to PRC-024-2

	Name	Entity
Chair	S. Bryan Burch	Southern Company
Vice Chair	Jeff Billo	ERCOT
Members	John Anderson	Xcel Energy
	Noel Aubut	Hydro-Quebec
	Gary Custer	SMA-America
	Louis Fonte	California ISO
	Mark Kuras	PJM
	Tracy MacNicoll	Utility Services, Inc.
	Rajat Majumder	Siemens Gamesa
	Amir Mohammednur	Southern California Edison
	Peter Wybierala	NextEra Energy
	Yishan Zhao	Duke Energy
PMOS Liaison	Linda Lynch	Florida Power & Light
NERC Staff	Mat Bunch, Standards Developer	North American Electric Reliability Corp
	Marisa Hecht, Counsel	North American Electric Reliability Corp
	Ryan Mauldin, Compliance	North American Electric Reliability Corp