



ERNEST ORLANDO LAWRENCE BERKELEY NATIONAL LABORATORY

Power and Frequency Control as it Relates to Wind-Powered Generation

John Undrill

John Undrill, LLC

December 2010

The work described in this report was funded by the Federal Energy Regulatory Commission, Office of Electric Reliability through a subcontract administered by the Lawrence Berkeley National Laboratory, which is operated by the University of California for the U.S. Department of Energy under Contract No. DE-AC02-05CH11231.

Disclaimer

This document was prepared as an account of work sponsored by the United States Government. While this document is believed to contain correct information, neither the United States Government nor any agency thereof, nor The Regents of the University of California, nor any of their employees, makes any warranty, express or implied, or assumes any legal responsibility for the accuracy, completeness, or usefulness of any information, apparatus, product, or process disclosed, or represents that its use would not infringe privately owned rights. Reference herein to any specific commercial product, process, or service by its trade name, trademark, manufacturer, or otherwise, does not necessarily constitute or imply its endorsement, recommendation, or favoring by the United States Government or any agency thereof, or The Regents of the University of California. The views and opinions of authors expressed herein do not necessarily state or reflect those of the United States Government or any agency thereof, or The Regents of the University of California.

Ernest Orlando Lawrence Berkeley National Laboratory is an equal opportunity employer.

Power and Frequency Control as it Relates to Wind-Powered Generation

John Undrill

John Undrill, LLC

December 2010

The work described in this report was funded by the Federal Energy Regulatory Commission, Office of Electric Reliability through a subcontract administered by the Lawrence Berkeley National Laboratory, which is operated by the University of California for the U.S. Department of Energy under Contract No. DE-AC02-05CH11231.

Abstract

This report is a part of an investigation of the ability of the U.S. power system to accommodate large scale additions of wind generation. The objectives of this report are to describe principles by which large multi-area power systems are controlled and to anticipate how the introduction of large amounts of wind power production might require control protocols to be changed.

The operation of a power system is described in terms of primary and secondary control actions. Primary control is fast, autonomous, and provides the first-line corrective action in disturbances; secondary control takes place on a follow-up time scale and manages the deployment of resources to ensure reliable and economic operation.

This report anticipates that the present fundamental primary and secondary control protocols will be satisfactory as wind power provides an increasing fraction of the total production, provided that appropriate attention is paid to the timing of primary control response, to short term wind forecasting, and to management of reserves for control action.

Acknowledgments

The work described in this report was funded by the Federal Energy Regulatory Commission, Office of Electric Reliability through a subcontract administered by the Lawrence Berkeley National Laboratory, which is operated by the University of California for the U.S. Department of Energy under Contract No. DE-AC02-05CH11231.

The Principal Investigator for the overall project is Joseph H. Eto, Lawrence Berkeley National Laboratory.

The author also acknowledges a review provided by William Mittelstadt.

The study author, alone, however, bears sole responsibility for technical adequacy of the analysis methods and the accuracy of the study results.

Table of Contents

Abstract.....	i
Acknowledgments.....	iii
Table of Contents.....	v
Table of Figures.....	vii
Table of Tables.....	ix
Acronyms and Abbreviations.....	xi
Executive Summary.....	xiii
1. Introduction.....	1
1.1 Scope.....	1
1.2 Integration with Existing Practices.....	2
1.3 Primary and Secondary Control.....	2
1.4 Modes of Power Plant Control.....	3
2. Simulation Models.....	5
2.1 General.....	5
2.2 Balancing Areas and Generating Plant Types.....	5
2.3 Basic Simulation Characteristics.....	7
3. Primary Control.....	9
3.1 Simple Droop Plant Control Mode.....	9
3.2 Simulations of Governing Response.....	9
3.3 Fraction of Capacity Providing Governing Response.....	9
3.4 Amount of Available Governing Response.....	11
3.5 The Role of Turbine-Generator Inertia in Frequency Dynamics.....	12
3.6 Role of Turbine Control Dynamics in Frequency Dip Response.....	15
3.7 Frequency Response Provided by Load.....	17
3.7.1 Voluntary Underfrequency Load Disconnection.....	17
3.7.2 Case A Simulations.....	18
3.7.2.1 8 percent turbine frequency response capability.....	18
3.7.2.2 6 percent turbine frequency response capability.....	20
3.7.2.3 4 percent turbine frequency response capability.....	21
3.7.3 Case B Simulations.....	23
3.7.3.1 8 percent turbine frequency response capability.....	23
3.7.3.2 6 percent turbine frequency response capability.....	24
3.7.3.3 4 percent turbine frequency response capability.....	25
3.7.4 Notes.....	26
3.8 Transmission Distance in Relation to Frequency Response.....	26

4. Secondary Control – Sudden Events	31
4.1 Sudden Load-Generation Unbalance	31
4.2 Load Frequency Control	32
4.3 Power Plant Controls (Plant Operation by DCS).....	34
5. Secondary Control - Ramping of Load and Generation.....	37
5.1 Normal Ramping of Load and Pre-scheduling of Generation	37
5.2 Very Rapid Ramps	45
6. Imperfections and Practical Matters	49
6.1 Deadband	49
6.2 Relating it all to Reality	52
6.3 Relationship between Dispatch and Control.....	60
7. Commentary and Conclusions.....	63
7.1 Requirements for System Control.....	63
7.1.1 Control of Frequency and Power Interchanges.....	63
7.1.2 Primary Control	63
7.1.3 Secondary Control	64
7.1.4 Wind Plant Control Response.....	64
7.2 Wind Power in Relation to System Control.....	66
7.3 Wind Plant Characteristics in Perspective	67
7.4 Options for Adaptation to Variable Resources	68
7.5 Quantitative Assessments	69
7.6 Qualitative Remarks.....	69
References.....	71
Appendix A. The Dynamic Simulation Model	73

Table of Figures

Figure 1. Single balancing area for frequency dip assessment	5
Figure 2. System with two balancing areas for examination of Secondary Control.....	6
Figure 3. Relative forms of Type A and Type B response	7
Figure 4. Primary response to 0.01 per unit load increase, $K_t=1.0$	10
Figure 5. Primary response to 0.01 per unit load increase, $K_t=0.3$	11
Figure 6. Primary response to 0.01 per unit load increase with limited response	12
Figure 7. Dependence of frequency nadir on system inertia constant, H	14
Figure 8. Summary of frequency nadir values.....	15
Figure 9. Dependence of frequency on the fraction of generation providing response.....	16
Figure 10. Dependence of frequency on principal response time constant	17
Figure 11. Effect of VLD - 8 pct prompt primary response capability.....	19
Figure 12. Effect of VLD - 6 pct prompt primary response capability.....	21
Figure 13. Effect of VLD - 4 pct prompt primary response capability.....	22
Figure 14. Effect of VLD - 4/4 pct prompt/slow primary response capability	23
Figure 15. Effect of VLD - 3/3 pct prompt/slow primary response capability	24
Figure 16. Effect of VLD - 2/2 pct prompt/slow primary response capability.....	25
Figure 17. Chain-form power system model to show propagation of disturbance through multiple blocks of inertia.....	26
Figure 18. Frequency deviations along a chain-form power system model in response to a generation trip at one end of the chain	27
Figure 19. Primary power response of turbines along the chain-form system to a generation trip at one end.....	28
Figure 20. Typical simulated response of WECC system frequencies to loss of generation	29
Figure 21. Simulation of two area systems – no LFC action.....	32
Figure 22. Simulation of two area systems - LFC active in both areas	33
Figure 23. Simulation of two area systems - LFC active in both areas, magnified x-axis	34
Figure 24. Effect of frequency bias in power plant preselected load control	35
Figure 25. Sample daily load cycle with significant ramp-up of load.....	37
Figure 26. Ramps of load and prescheduled generation for illustrative examples	38
Figure 27. Response to ramps of load in both balancing areas - no LFC action	39
Figure 28. Response to ramps of load in both balancing areas - no LFC action - increased primary control participation.....	40
Figure 29. Response to ramps of load in both balancing areas - LFC active	41
Figure 30. Response to ramps of load in both balancing areas - LFC active - increased primary control participation	42
Figure 31. Response to load ramps - Limited primary response headroom - LFC active	43
Figure 32. Response to load ramps - Limited primary response headroom - LFC active - increased primary control participation.....	44
Figure 33. Response to concurrent ramps of load and wind power production - adequate secondary response capability	46
Figure 34. Response to concurrent ramps of load and wind power production - insufficient secondary response capability	47
Figure 35. Effect of governor deadband of 0.02 percent speed	50

Figure 36. Effect of governor deadband of 0.02 percent speed - limited primary response availability	51
Figure 37. Effect of governor deadband of 0.02 percent speed - LFC active.....	52
Figure 38. Sample A – Response of WECC system frequency to loss of generation	53
Figure 39. Sample B – Response of Texas system frequency to loss of generation.....	54
Figure 40. Sample C - Response of Eastern Interconnection frequency to loss of generation....	55
Figure 41. Sample D - Response of Eastern Interconnection frequency to loss of generation....	55
Figure 42. Simulation of response to loss of generation over a 60 second time span reproducing the general form of Figure 35 with simulation of primary control action in absence of load frequency control.....	56
Figure 43. Extension of Figure 37 to 600 second time span with simulation of primary control action in absence of load frequency control.....	57
Figure 44. Sample E - Response of Texas system to loss of 750MW over a 120 second time span	58
Figure 45. Sample E - Response of Texas system to loss of 750MW over a 22 minute time span	59
Figure 46. Simulation of Response to loss of generation over a 600 second time span and reproducing the general form of Figure 38	60
Figure A- 1. Energy balance representation of power and speed behavior	73
Figure A- 2. Very simple load frequency control model	74
Figure A- 3. Simple transfer function representation of turbine dynamic response	74

Table of Tables

Table 1. Summary of Variables	31
-------------------------------------	----

Acronyms and Abbreviations

ACE1	Balancing area 1 Area Control Error
ACE2	Balancing area 2 Area Control Error
BA	Balancing Area
DCS	Digital Control Systems
Freq1	Frequency - balancing area 1
Freq2	Frequency - balancing area 2
Hz	hertz
LFC	Load Frequency Control
mHz	millihertz (10^{-3} hertz)
MW	megawatt (10^6 watt)
Net Interchange	Real power flow on inter area transmission path
P-C1A	Power output of responsive turbine A in balancing area 1
P-C1B	Power output of responsive turbine B in balancing area 1
P-C2A	Power output of responsive turbine A in balancing area 2
P-C2B	Power output of responsive turbine B in balancing area 2
RES1	Total power output of balancing area 1
RES2	Total power output of balancing area 2
VLD	Voluntary load disconnection
WECC	Western Electricity Coordinating Council

Executive Summary

General

This report is a part of an investigation of the ability of the U.S. power system to accommodate large scale additions of wind powered generation. For more information on this larger effort, please see Eto et al. 2010.¹

The two objectives of this report are to:

- review the principles by which frequency and power flows are controlled
- illustrate the relative roles of primary and secondary control action in maintaining the frequency and key power flows of the grid within appropriate limits

The discussion is carried on by means of example simulations using simple microcosm-level models of power system dynamics. These simulations are not intended to provide detailed quantitative indications of the amount of wind power generation that can be accommodated. Rather, they are used to provide concise illustrations that will clarify the features of the detailed simulation work presented elsewhere in the main report.

Primary and Secondary Control

Control of the power system is undertaken at two levels commonly referred to as primary and secondary control.

Primary control is the second-by-second action of turbine governors. It is the essential function in the maintenance of steady operation as the system experiences normal small short term variations of load. It must always be present in this role. Further, and of prime importance in this discussion, primary control provides the essential defensive function of arresting deviations of frequency when the power system experiences a sudden large disturbance of its generation or load. Primary controls related to frequency and real power are entirely within the power plants, and autonomous. The primary control of each individual turbine-generator is single minded in its focus on that turbine.

Secondary control is the action of elements that supervise the primary controls to manage the allocation of loading among the many plants of the system. This allocation of loadings to individual plants is the means by which the loadings of transmission lines are managed and is essential for reliability of the transmission grid. The adjustment of generation, minute-by-minute, in the presence of continual, but not sudden, changes in system conditions is the

¹ Eto, J. H., J. Undrill, P. Mackin, R. Daschmans, B. Williams, B. Haney, R. Hunt, J. Ellis, H. Illian, C. Martinez, M. O'Malley, K. Coughlin, K. H. LaCommare. 2010. Use of Frequency Response Metrics to Assess the Planning and Operating Requirements for Reliable Integration of Variable Renewable Generation. LBNL-4142E. Berkeley: Lawrence Berkeley National Laboratory.

responsibility of secondary control. Secondary control functions are executed both within power plants and in Balancing Area operations centers.

The action of primary control is much quicker than can be accomplished continually by human operators. Secondary controls are intentionally slower acting than primary controls; they are, in effect, the automation of functions that could be handled by continuously attentive human operators.

Provision of Control Action

While it is not essential that every power plant contribute primary and secondary control action to the grid, it is essential that the system be dispatched and the plants be operated such that contributions of primary and secondary control action are sufficient in amount, in timing of deployment, and in geographical location.

Primary Control

The main report advocates Frequency Response as a key measure of the adequacy of power system control resources and hence of system reliability. Frequency Response, as defined in the main report, is the collective primary control response of the generating plants in the power system to a dip in grid frequency, where the frequency dip is most often (but certainly not always) the result of the sudden disappearance of a block of generating capacity.

The illustrative simulations presented here show the importance of having the power system carry proper reserve for the provision of Frequency Response. The introduction of wind power plants is not expected to change the amount of reserve required for Frequency Response. The introduction of a large amount of wind powered generation will, however, make it necessary to sharpen the attention that is paid to the speed of deployment of Frequency Response.

Secondary Control

In the context of this discussion the task of secondary control is to ensure that the system is always positioned so that the required amount of primary control action will be available if called for. Secondary control action should restore reserves for primary control promptly after a sudden disturbance has caused Frequency Response to be deployed, and should follow foreseeable variations of load and generating plant output closely so as to use the smallest possible amount of primary control action in normal conditions. A low level of primary control action is present at all times; primary control action will be used beyond this essential low level if secondary control action is not sufficient and appropriate.

Secondary control capability takes on particular importance when there is a large unplanned change, particularly a reduction, in wind power production. Rapid ramping of power production, if coincident with opposite ramping of load, will significantly increase both the rate at which secondary control action must be deployed and the amount of the deployment.

Indications and Conclusions

While it is not the purpose of this report to draw conclusions, the discussion does give some useful indications with regard to the introduction of wind powered generation on the presently foreseeable scale:

- it will not require extensive technical changes in the way the grids provide Frequency Response but will require diligence in the observance of policies and practices regarding primary control
- it will not require significant increases in reserves for Frequency Response
- it will require improved attention to the management of reserve for primary control with respect to its dynamic characteristics
- it will increase the need for reserves of on-line generation for secondary control action

1. Introduction

1.1 Scope

This discussion considers the control of system frequency and the flow of real power between balancing areas (BA) of the transmission grid. The discussion is a part of the broad field of considerations raised by the introduction of a large amount of variable renewable generation into the electric power system. The immediate subject is wind-powered generation but, with few exceptions, the points raised here apply equally to photovoltaic solar and other types of non-storage renewable generation.

Frequency-and-power control is but one of a large number of engineering issues that are touched by the introduction of wind-powered generators. It is distinctive and warrants attention because the control of frequency in particular, and the control of real power flows to nearly the same extent, are grid-wide issues. Local system design issues and issues of electrical behavior associated with wind-powered generators are assumed for the purpose of this discussion to have been solved or to be solvable. Our concern here is whether, with electrical issues solved, the systemwide issues of frequency and interarea power flow control can be managed in a system with a high percentage of wind-powered generation.

The control of frequency and real power flow is accomplished by manipulating the controls of the turbines of the power system, not by manipulating controls on the electrical side of the power system. For this reason, throughout this discussion we refer to the machines that are our concerns as turbines and not as generators.

The objective of this discussion is to show the basic principles of power system control that define the environment that wind power plants must operate in and the community of which they will be citizens. There is little reference to the specific characteristics of wind power plants in this discussion. The concern here is to understand the distinctions between plants that are responsive to the key signals of power system operation and those that, for various reasons, operate with little or no response to changing grid conditions. Wind power plants presently being installed in the USA are not responsive to grid frequency or to the load frequency control (LFC) commands issued by BAs. In this regard they are very similar to the many conventional power plants that are operated in nonresponsive control modes.

The quick ramping of wind power plant output differs from the quick ramping of a large conventional plant in that it is more likely and in that the collective ramping of a concentration of wind plants could produce faster ramping, over a wider span, than has been seen with the traditional turbine fleet.

The presence of wind power plants in the system narrows the range of choice available to the system operator in assigning primary and secondary control duty. This makes it necessary to assess the effect on frequency control of changing the fraction of the on-line turbine capacity that provides the two key forms of control response. That assessment is the primary objective of this discussion.

1.2 Integration with Existing Practices

The fundamental principles by which the power system is controlled and operated are those of the existing fleet of generating plants. These plants are based on synchronous generators driven by turbines that are intended to operate at substantially constant speed. The introduction of any new generating technology into the system must be done in a way that is compatible with the operational principles of the existing system. Surely, some details of present operating practice might be changed to accommodate the introduction of new technology but, equally surely, many cannot.

Given this, it is useful to examine the effect of variations that have been made, or that could be made, in the way the present power system is operated. This examination is made by simulations using the microcosm level power system models shown in Figure 1 and Figure 2. These models do not consider details of the transmission system or the fundamental synchronization process of the electric machinery. Their focus is the way the turbine controls influence and can be used to control grid level variables. It should be noted that, just as this discussion assumes satisfactory operation of the electric transmission, the engineering of the electric transmission system assumes satisfactory operation of the generation system in the sense discussed here.

1.3 Primary and Secondary Control

The power system requires both *Primary Control Response* and *Secondary Control Response* from turbines connected to it. It is neither possible nor necessary for all turbines to contribute to these control responses but a sufficient quantity and appropriate geographic distribution of each is essential. Primary control is the essential means by which the grid is assured to be stable and controllable. Secondary control is used to manage resources. Secondary control systems are used to maneuver power plants in accordance with a broad field of considerations including energy markets, transmission security requirements, and internal operational necessities of individual power plants. For this discussion, the overriding interest in secondary control is its role in ensuring that the power system is secure in the sense that it is always prepared to deal with the contingencies that are inherent in power system operations.

Primary Control is the immediate control of the relationship between turbine speed and power that is exerted by turbine governor. *Primary Control Response* is the change of turbine power produced by the governor in response to a change in turbine speed. The grid is operated on the basis that the primary controls of turbines are autonomous and will function continuously to enforce the required relationship between speed and power without requiring inputs from any external source. *Primary Response* to frequency changes is an inherent property of turbine governing and is depended on, millisecond-by-millisecond as the fundamental phenomenon that keeps the grid in stable equilibrium.

Secondary Control is the control by which turbines respond to commands issued by external entities. Secondary control inputs are normally applied to the governor speed-load references. It is common for a modern power plant to have several distinct modes of secondary control

implemented within the plant and, also, to be able to accept secondary control inputs from sources external to the plant. For example, a multiunit hydro plant would typically have a plant controller whose objective is to optimize the allocation of loading among the several turbines to make best use of water. This plant controller would be able to accept a setpoint for total plant output either as a local manual operator input or from a grid control center via telecontrol. In addition, there is the possibility of the telecontrol from the grid control center delivering input signals directly to the governor speed-load references, bypassing the plant controller. All of the many ways of manipulating the governor references are secondary control in that they are means by which grid operators can control the turbines by the issuance of instructions.

A key distinguishing difference between primary and secondary control is that a power system would be able to operate steadily, for a few minutes at least, with no secondary control action being taken, but that it would not be possible for it to operate at all without the exertion of effective primary control.

Another useful distinction is that primary control is the immediate feedback control function that regulates the power of the turbine on a time scale that is much quicker than a human operator could achieve, while secondary control is most often the automation by a computer of a function that could be done by an attentive human operator.

A last distinction is that primary control is the enforcement of a simple and purely local control objective for each turbine individually, while secondary control is mainly concerned with managing the relationships between multiple turbines. Both levels of control affect transmission flows; this effect is a byproduct of primary control action and one of the main objectives of secondary control.

1.4 Modes of Power Plant Control

The control service available to the grid, for both primary and secondary control, is determined by the ways the individual power plant operators choose to run their machines. Few turbines are controlled manually, though manual control is possible in some special situations. The great majority of the turbines on the grid are operated by unit, plant, and grid level control systems that can be put into a very wide variety of modes. The plant control modes that account for the majority of the capacity and are of interest here are:

- a. **Simple droop mode.** The governor receives secondary control inputs only by manual actions of the turbine operator. A turbine running in simple droop mode provides primary control response to the grid but no automatic or dependable secondary response.
- b. **Preselected load mode without frequency bias.** A plant controller applies secondary control commands to the governor speed-load reference to hold the plant at a prescheduled output without reference to grid frequency. This prescheduled output typically is a constant or a ramp at a preset rate. In this mode a turbine provides primary response temporarily when grid frequency changes, but is returned to its preprogrammed value by the secondary control.

- c. **Preselected load mode with frequency bias.** A controller applies secondary control commands to the governor speed-load reference to hold the plant at a prescheduled output with the prescheduled output being biased by deviation of grid frequency. The prescheduled output is stated as the output to be produced when grid frequency is at scheduled value. This prescheduled output typically is a constant or a ramp at a preset rate. In this mode a turbine provides primary response on a sustained basis when grid frequency changes.
- d. **Load frequency control mode.** The speed-load reference of the turbine is manipulated by signals received from the LFC system of the BA. In this mode the turbine provides primary control and whether this primary control response is sustained or not depends on the secondary control action of the LFC System.
- e. **Non-responsive mode.** The turbine control valves are wide open or are under the command of a controller that does not respond to turbine speed or grid frequency, such as the exhaust temperature limiter of a gas turbine or the pressure controller of a steam turbine. For the purpose of this discussion a non-responsive turbine provides neither primary nor secondary control response.

The way these control modes are used has been influenced very strongly by commercial energy and power trading arrangements in recent years and, as a result, there has been a widespread lack of appreciation of how the plants' choices of control mode affect the behavior of the grid.

2. Simulation Models

2.1 General

This discussion is carried on in terms of simulation results. Accordingly, the first step is to describe the simulation model that is used throughout the discussion. Details at the level of equations are provided in Appendix 1.

2.2 Balancing Areas and Generating Plant Types

Simulations are made with the two small scale simulation models shown in Figure 1 and Figure 2. These models consider a power system to be made up of electric load (with transmission losses being a part of the electric load), turbines whose power drives the generators supplying that load, power plant controls, and grid-level LFC.

Figure 1 shows a power system model in which there is no concern for power flows between parts of the system; the only variables of interest are the system synchronous speed (frequency) and the turbine power outputs.

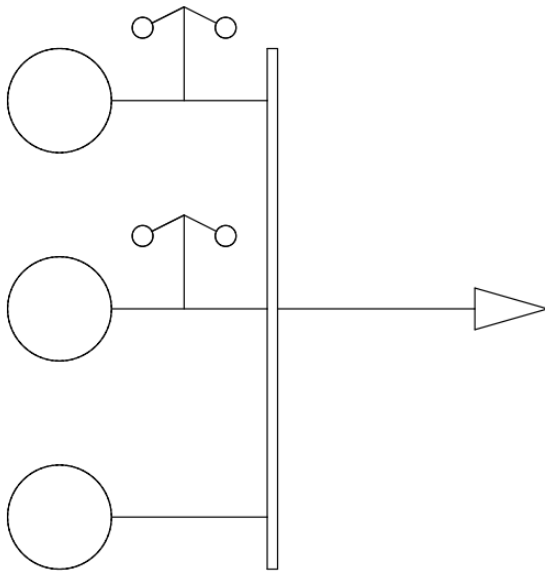

Figure 1. Single balancing area for frequency dip assessment

Two groups of responsive generation and remainder is nonresponsive

Figure 2 shows a power system in which two BAs are interconnected by a transmission path whose capacity is small in relation to the generating capacities of the two areas. With this system model the power flow on the interconnecting transmission path is of interest, as well as turbine powers and frequency.

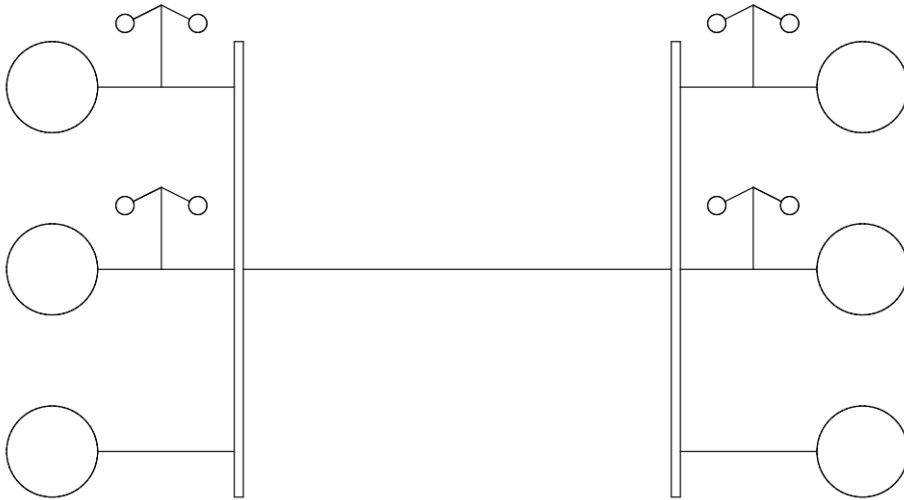

Figure 2. System with two balancing areas for examination of Secondary Control

Responsive and nonresponsive generation in each area

The basic principles of LFC and the features of the associated simulation models are well known. For more information, see references 1- 3.

The simulation model recognizes the variations in control capability associated with the many modes of plant operation by grouping the generating capacity of each BA into blocks with dynamic characteristics as follows:

- Type A. Plants whose turbines can change power output very quickly over a limited range from a near-steady initial condition but which can vary the power output only relatively slowly after the limited range has been traversed. Most steam and large gas turbine plants belong in capacity block.
- Type B. Plants whose turbines can change output from a near-steady condition only at a relatively slow rate but which can continue to change output at this rate over the entire turbine capacity. Many, though far from all, hydro plants fall into this block.
- Type C. Plants in which turbine power output is substantially constant over periods from a few seconds to a few minutes.

The distinction between types A and B is illustrated in Figure 3.

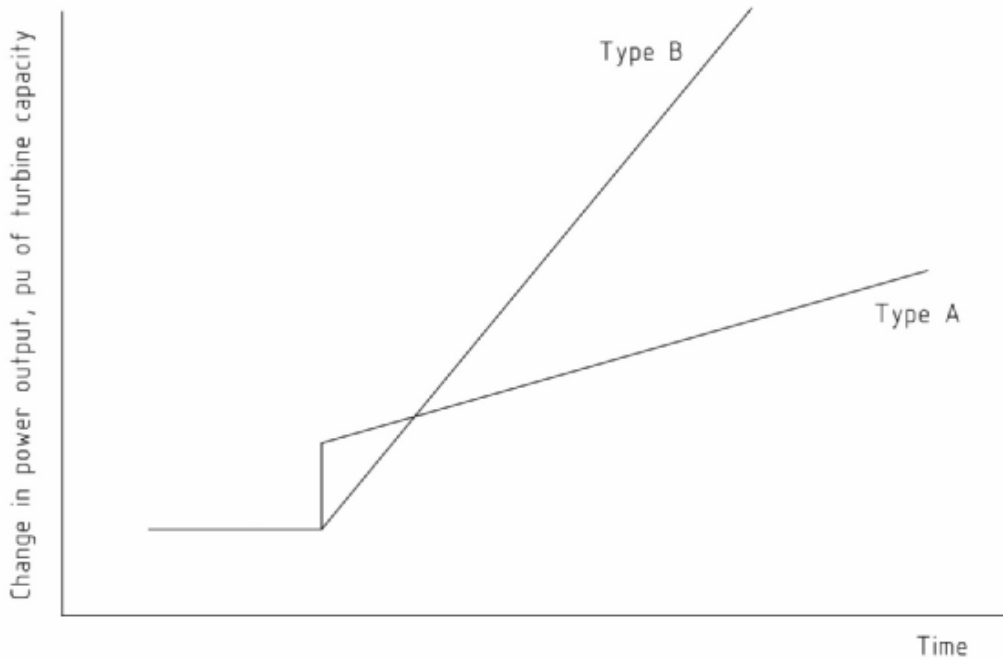

Figure 3. Relative forms of Type A and Type B response

Each BA is modeled as having two maneuverable blocks of generating capacity with other turbine capacity operating in non-responsive modes. The maneuverable generation can be type A or B turbines in plants operating in the responsive control modes of Section 1.4.

The fractions of the total turbine capacity in each BA assigned to these maneuverable capacity blocks and the control modes in use in these blocks are the variables in this discussion. The premise is that each BA has a substantial number of turbines and that these machines are allocated to differing operational regimes in varying numbers. The simulation model is stated in per unit terms; each BA has a total connected turbine capacity of one per unit. Except where otherwise stated the total load served in each BA is 0.8 per unit. The strength of the interconnecting transmission of Figure 2 is chosen to give the inter-area oscillation a natural frequency of close to 0.25 Hz.

2.3 Basic Simulation Characteristics

The steady state behavior of the simulation models is given by the well known relationships between turbine speed, tie line power flow, and the Area Control Error (ACE) of the BAs.

$$\Delta n = \frac{-\Delta P_l + \Delta P_t}{D + \frac{K_t}{R}} \quad (1)$$

$$\Delta P_t - \Delta P_l - \Delta P_i = 0 \quad (2)$$

$$ACE = \Delta P_i + B \Delta n \quad (3)$$

$$B = \left(D + \frac{K_t}{R} \right) \quad (4)$$

where

Δn is deviation of synchronous speed from scheduled value

ΔP_t is the collective deviation of turbine power from pre-event value

ΔP_l is the change in load-plus-losses from the pre-event value

ΔP_i is deviation of intertie net real power flow from pre-event value

D is frequency sensitivity coefficient of load (load damping factor)

K_t is fraction of connected turbine capacity providing sustained primary control response

R is governor droop

B is frequency bias factor for the balancing area

The collective deviation of turbine power output, ΔP_t , is the summation of the power output deviations of the individual turbines.

The parameter, K_t , is the fraction of the connected capacity on the BA that contributes governing response; that is, K_t is the sum of the fractions of turbine capacity of types A and B of Section 2.2.

The ideal LFC is achieved if the frequency bias factor, B , of each BA is set in accordance with (4) when normalized to the generating capacity of the BA.

The dynamics of the simulation model is defined by the collective acceleration equation for each BA and on transfer function descriptions of the governing response of the type A and type B turbines. These transfer function relationships are given in the appendix and are shown in Figure A- 3.

LFC is modeled in these simple simulations as a pure integral control; the speed-load reference of each turbine operating in LFC mode is adjusted at a rate proportional to the ACE of the BA. The ACE is allocated to turbines in proportion to their capacities.

3. Primary Control

3.1 Simple Droop Plant Control Mode

The immediate first necessity in controlling the power system is to maintain the balance between load and generation when load is changing. The best indicator of this balance, or unbalance, is the grid frequency. The first and overriding requirement of grid control is to arrest deviations of grid frequency promptly and at small amplitude. This is primary control and is implemented by governors; it must happen very quickly and it is single minded in its focus on frequency. Commercial arrangements and optimal use of resources are left to be handled by secondary control. When all is going according to plan plant primary control response is present continually, though small in amplitude.

Sections 3.2 through 3.7, illustrate the importance of proper primary control in terms of the grid frequency deviations that can be produced by sudden unbalances of load and generation. The most common cause of such sudden unbalances is the tripping of a large generator. The illustrations in these sections consider only primary control; all responsive plants are in control modes in which they can provide and sustain primary response.

3.2 Simulations of Governing Response

We start by considering the response of the group of generators and loads connected at a single point as shown in Figure 1. For this example, the connected turbine capacity is 1 per unit and the initial load is 0.8 per unit. The load is increased suddenly by 0.01 per unit. That is, the total system load suddenly exceeds the total power production by one percent of the system's power production capacity.

Both the fraction of the generation in the system that participates in governing and the amount of response that the participating units are able to provide are important factors in determining the change of speed that an imbalance of load and generation will produce. The fraction, K_t , participating in governing strongly influences the rate at which power production can be adjusted to remove the imbalance. The synchronous speed can only recover from an initial dip to the level predicted by (1) if the 'headroom' on the governing units is sufficient to cover the entire excess of load over initial generation.

3.3 Fraction of Capacity Providing Governing Response

First, consider the fraction of the total generation that contributes governing action. Figure 1 shows the response of synchronous speed expressed in terms of deviation of frequency from the base value of 60 Hz when all turbines contribute governing response, (the governing fraction, K_t , is unity). The nadir of frequency occurs 2.6 seconds after the initiation of the event at a deviation of -0.073 Hz. The speed then rises to settle at exactly the value predicted by (1) for the case with $K_t=1.0$.

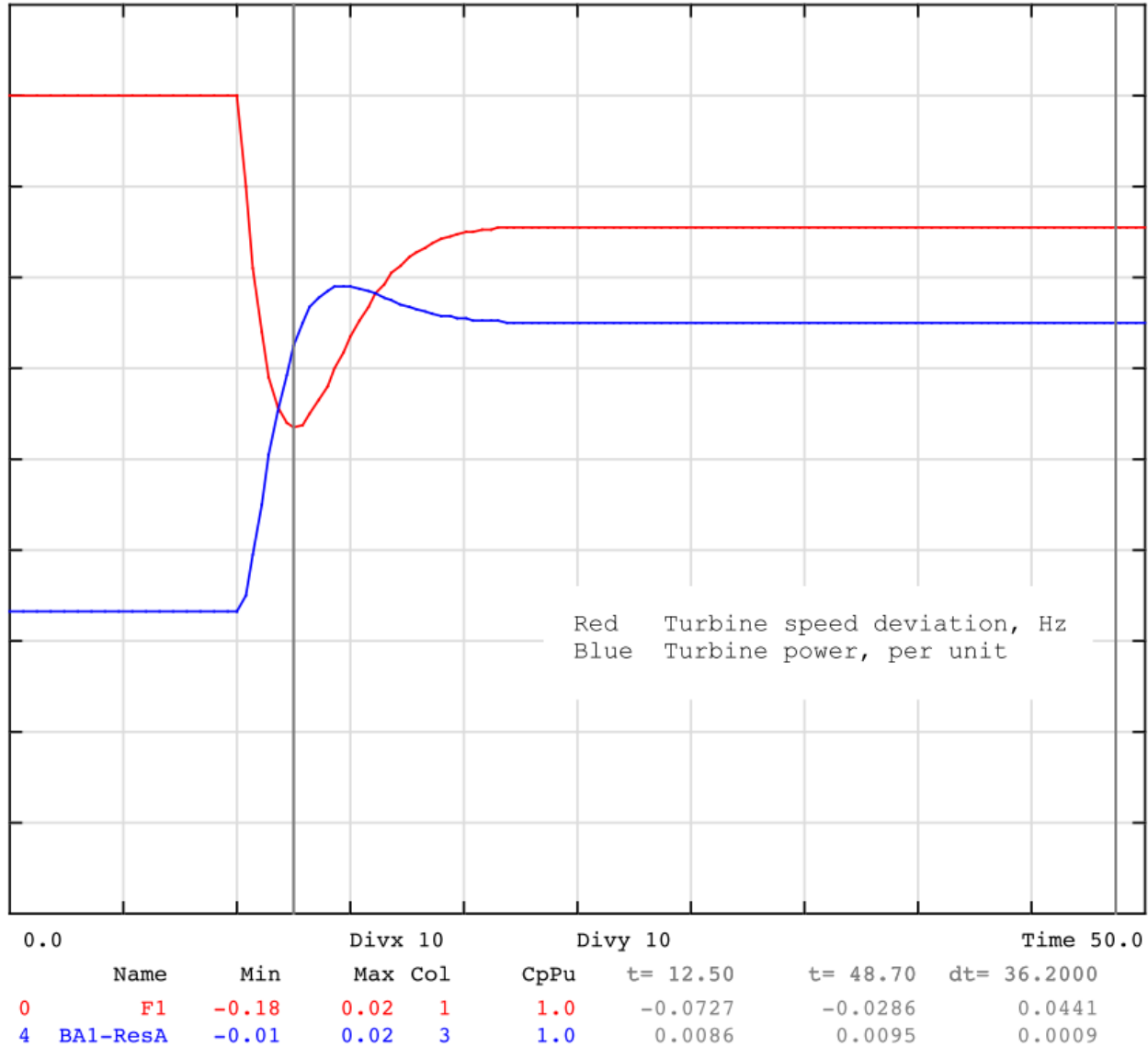

Figure 4. Primary response to 0.01 per unit load increase, $K_t=1.0$

*Single area system model of Figure 1
All generation contributes primary response*

This rather quick response would be expected in a small power system in which all turbines are operating in governing mode and all are of quick-responding type such as aeroderivative engines. However it is not what would be expected of a large power system because in a large system a substantial fraction of the turbines would be operating in control modes where the governors are not in command. Experience with the Western Electricity Coordinating Council (WECC) system is that 30 to 40 percent of the on-line capacity operates with governors in command, resulting in a value of 0.3 to 0.4 for the parameter, K_t . Figure 5 shows the result of the same simulation as Figure 4 but with K_t reduced from unity to 0.3. The frequency nadir is at a deviation of -0.15 Hz after 5.8 seconds; the settling frequency is now -0.086 Hz, again in accordance with (1).

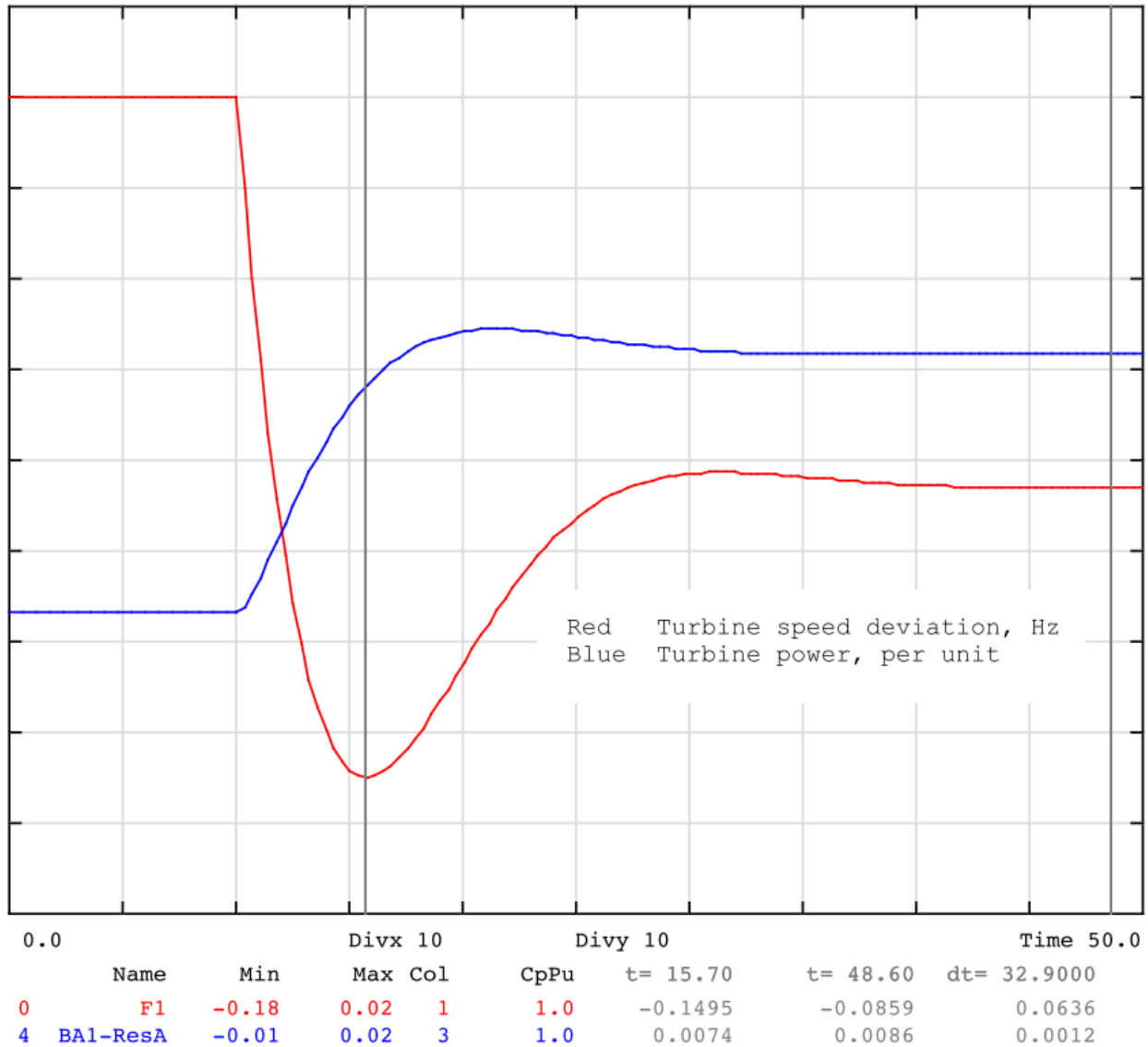

Figure 5. Primary response to 0.01 per unit load increase, $K_t=0.3$

*Single area system model of Figure 1
30 percent of generation provides primary response*

The frequency nadir shown in Figure 5 is in fairly close agreement with the experience of the WECC grid.

3.4 Amount of Available Governing Response

Next, consider the effect of having insufficient primary response capability. Figure 6 shows the response of synchronous speed when the same fraction of turbine capacity, $K_t=0.3$, is in governing mode, but where the headroom allowing these units to increase output is only 0.005

per unit, instead of the 0.01 per unit needed to 'cover' the increase in load. The frequency response shown in Figure 6 has a much greater frequency deviation at its nadir (-0.336 Hz) and does not recover significantly above its nadir. This L-shaped has been seen in the Eastern U.S. interconnection following substantial losses of generation.

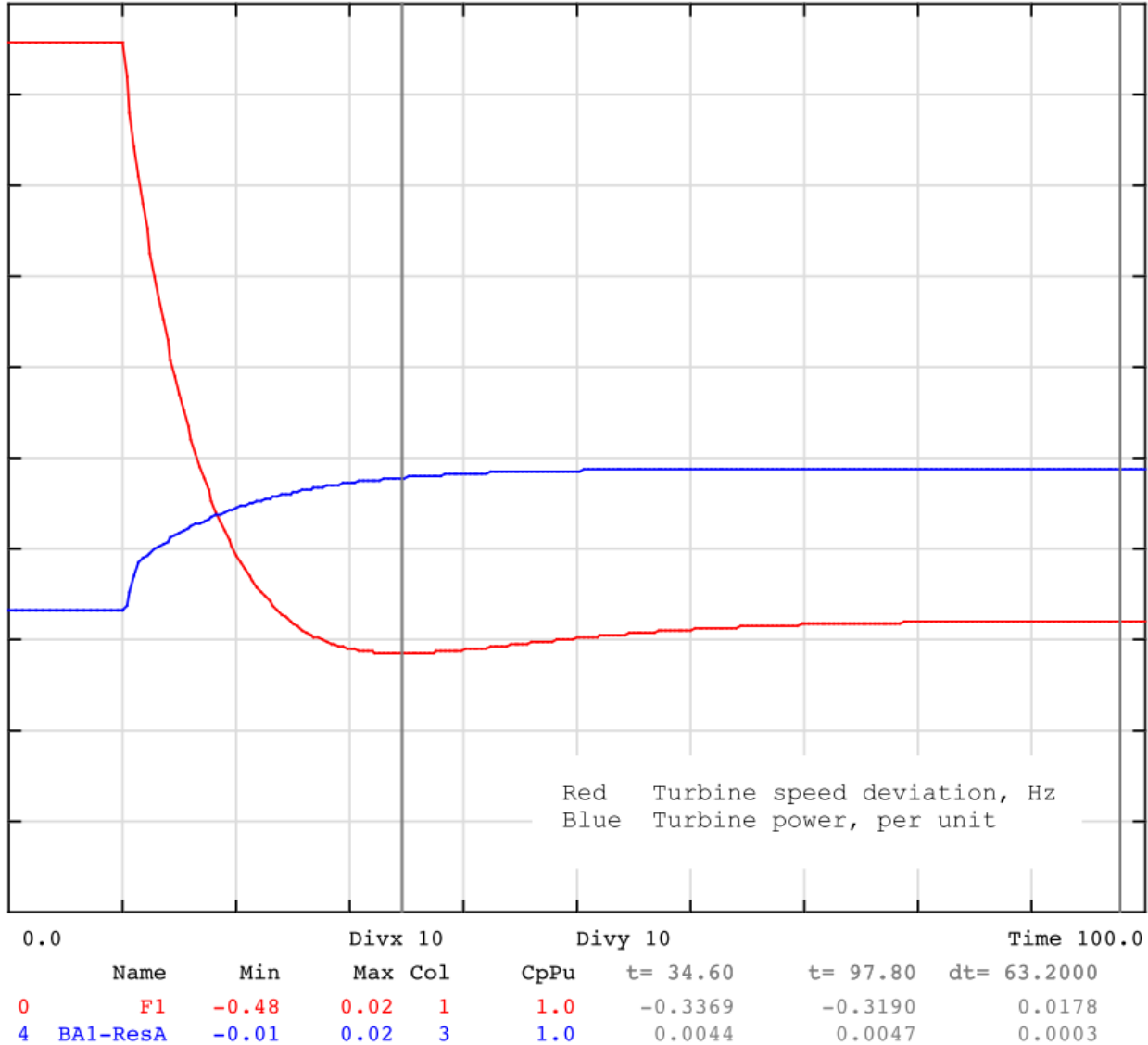

Figure 6. Primary response to 0.01 per unit load increase with limited response

*Single area system model of figure 1
 30 percent of generation provides primary response
 Total primary response is limited to 0.005 per unit*

3.5 The Role of Turbine-Generator Inertia in Frequency Dynamics

A recent concern has been that a reduction in the inertia constant of a power system, possibly by the widespread introduction of machinery having lower-than-normal inertia, would lead to

severely increased frequency deviation at the nadir after a sudden appearance of load or loss of generation.

The standard analysis, implemented as shown in Figure A- 1, indicates that the initial rate of decline of frequency produced by a sudden unbalance of load and generation is given by $dP/2H$ where dP is the magnitude of the imbalance and H is the inertia constant of the system. (Note that dP and H are normalized parameters; dP is dimensionless and H is in seconds.) Figure 4, Figure 5, and Figure 6 confirm this.

Figure 7 addresses this issue. It shows the response of the system to the same load change as used for Figure 5, with the same fraction of generation providing governing response. The four traces were made with the turbine-generator inertia constants set at 2.5, 3.75, 5, and 6.25 seconds respectively. This range of inertia covers the practical extremes that would arise with synchronous generating units.

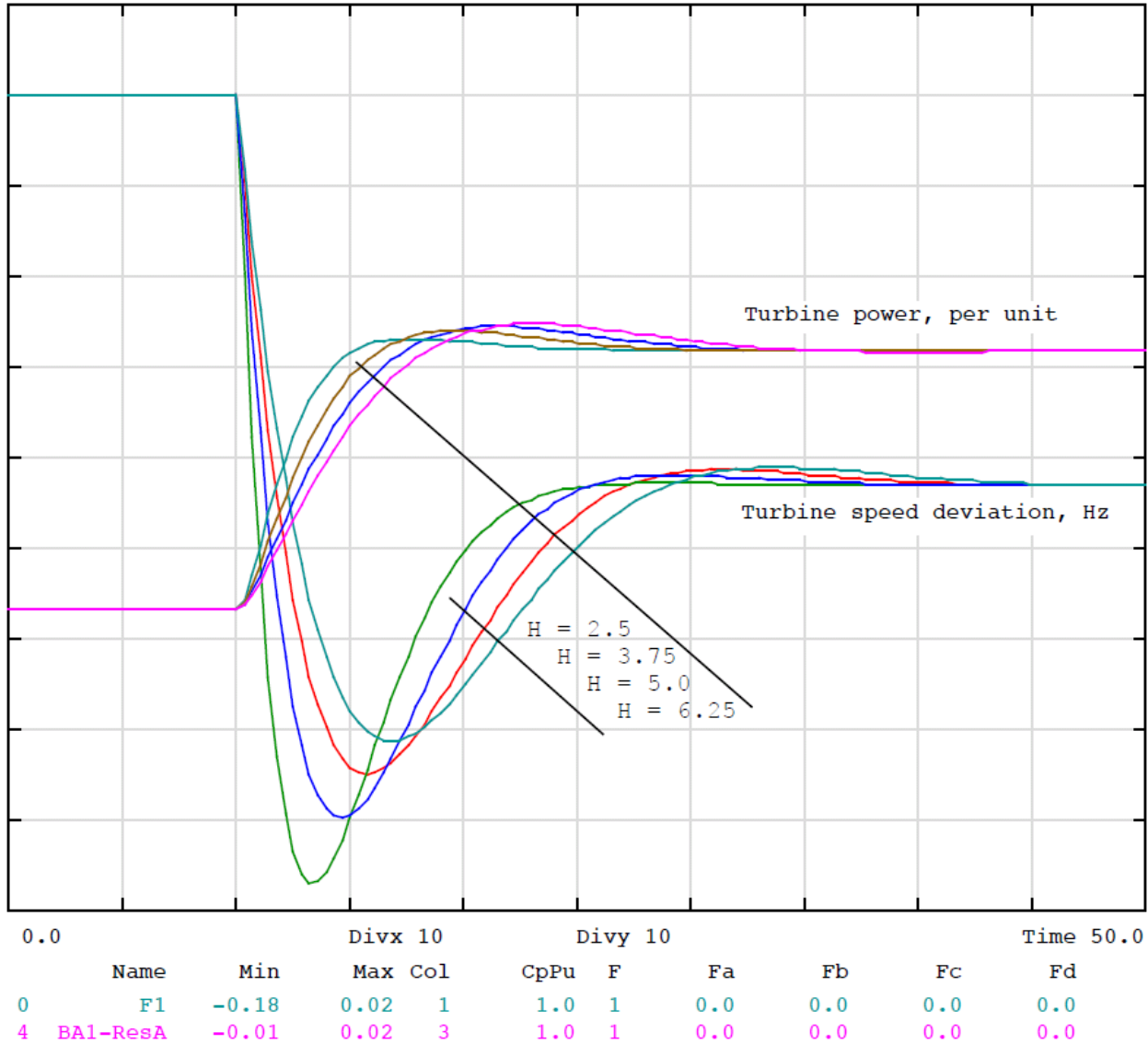

Figure 7. Dependence of frequency nadir on system inertia constant, H

*Single area system of figure 1 and 0.01 per unit load increase
30 percent of capacity provides primary response: $Kt = 0.3$*

A scan of the 2009 WECC simulation data base showed the overall system inertia constant to be 3.9 seconds. A system consisting entirely of aeroderivative machines could have an inertia constant as low as 2.5. To have an overall inertia constant as high as 6.25 seconds a system would have to be made up almost entirely of large industrial gas turbines.

Figure 8 summarizes the simulation results, showing nadir frequency versus system inertia constant. These simulations (Figure 7) show that changing inertia constant by a ratio of 2.5:1 changes the frequency nadir by a ratio of only 1.23:1. While inertia constant certainly affects the magnitude of the frequency dip, halving inertia is certainly not so severe that it doubles the dip. The more significant effect of reducing inertia constant is that it makes the dip in frequency

occur more quickly and thereby reduces the time available to protection systems for discrimination between situations that require action and those that do not. The family of traces shown in Figure 7 were made with a fixed proportion of type A and B plants such that 30 percent of the connected capacity contributed primary response ($K_t=0.3$). Further simulations with varying proportions of type A and B plants would show that decreasing system inertia increases the importance of prompt delivery of primary control response.

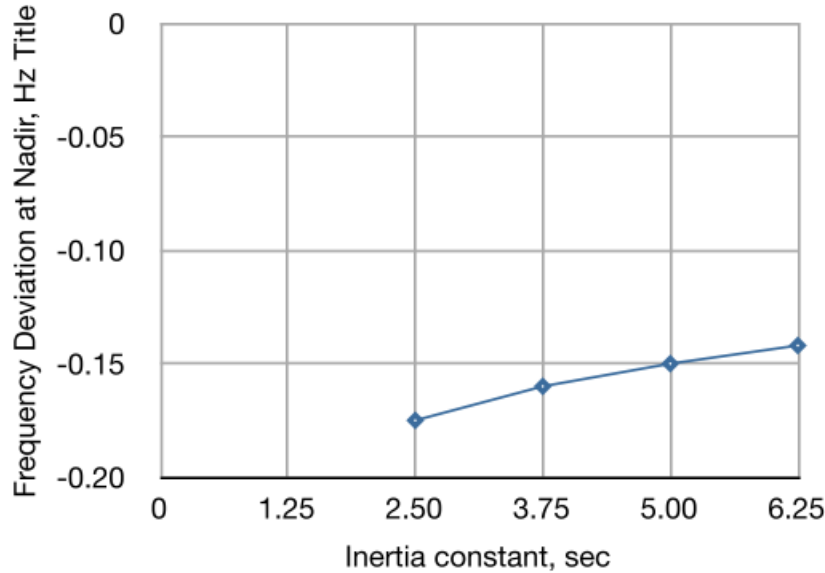

Figure 8. Summary of frequency nadir values

3.6 Role of Turbine Control Dynamics in Frequency Dip Response

In addition to the fraction of generating capacity contributing governing action and the amount of headroom available for governing, the promptness with which turbines respond to the commands of their governors is a key factor in determining how the grid synchronous speed will behave.

We now consider the results of simulations made with variations in the fractional representation of the turbine types in the system. Figure 9 and Figure 10 summarize simulations of the response to the sudden appearance of an unbalance of load and generation of three percent of the running generating capacity.

First consider Figure 9. This figure shows the nadir of frequency in simulations where a varying fraction of the total turbine capacity is of type A and contributes to governing, with all other capacity being of type C. Type A capacity was represented by the transfer function of Figure A-3 with parameters set as often used to represent the response of steam turbines to governing action:

$$\begin{array}{ll} R = 0.05 & T_a = 0.5 \\ P_{fa} = 0.3 & T_b = 10.0 \end{array}$$

The headroom available on the governing turbines is sufficient to cover the required three percent increase in generation. All generation has an inertia constant of 4 seconds for these simulations.

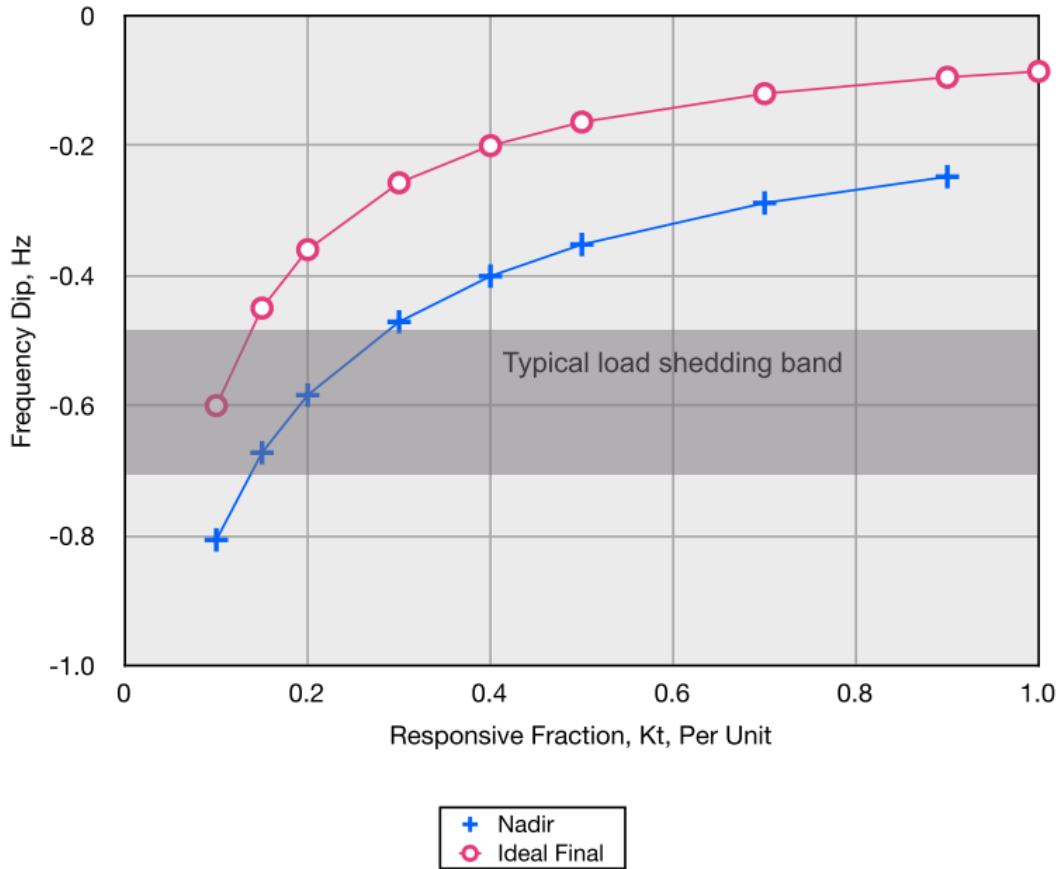

Figure 9. Dependence of frequency on the fraction of generation providing response

Blue cross= frequency nadir, Red circle= settling frequency

The red curve in Figure 9 shows the frequency at which the system would settle if governing were to be the only control action taken. It is as expected on the basis of equation (1). The blue curve shows the nadir frequency value. In the 30 to 40 percent range that is characteristic of the WECC system the nadir frequency is clearly very sensitive to the fraction of turbine capacity that contributes to governing. Comparison with simulations varying the inertia constant, such as those shown in Figure 7 indicate that variation of governing capacity percentage is as important as variation of connected inertia with regard to the magnitudes of frequency dips.

Figure 10 shows the dependence of the frequency nadir on the principal time constant of the governor-turbine subsystems. In this figure the abscissa variable is the time constant, T_b , characterizing the response of the turbine to a quick change of control valve position. A fraction, P_{fa} , of the change in turbine power produced by a change of control valve opening is assumed to be delivered promptly and the remaining change is assumed to appear with the time constant, T_b .

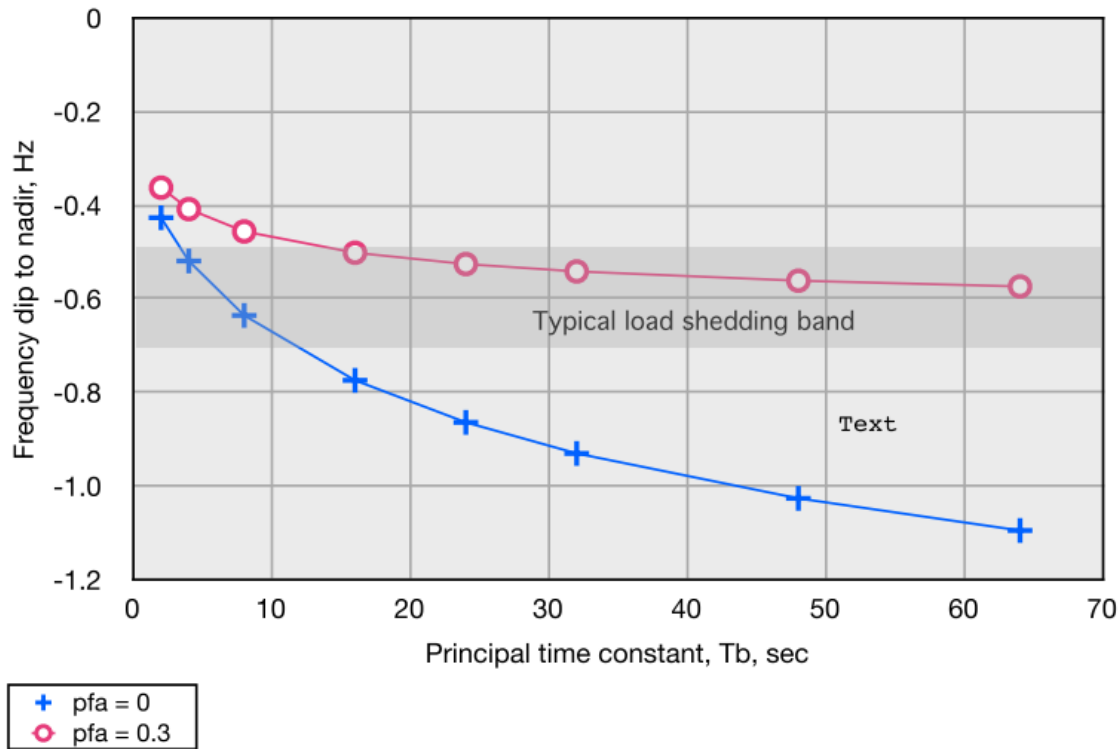

Figure 10. Dependence of frequency on principal response time constant

30 percent of capacity provides response

Blue cross= all responsive generation has stated principal time constant

Red circle= 30 percent of responsive is produced promptly and 70 percent follows with the principal time constant

The blue curve in Figure 10 is for the pessimistic case where only a vanishing fraction of the turbine power appears immediately; this characterizes plants where the governor is adjusted for very slow response, as might be done in a hydro plant with an unfavorable water column characteristic for example. The red curve shows the frequency nadir for the more optimistic case where thirty percent of the power response appears immediately and the balance follows with the time constant, T_b . Both curves show that changes in the dynamic response of the turbines are a significant influence on the frequency dip transient.

3.7 Frequency Response Provided by Load

3.7.1 Voluntary Underfrequency Load Disconnection

While involuntary load shedding is used only as a last resort to arrest a decline in system frequency in extreme conditions, voluntary load disconnection (VLD) is regarded in several power systems as an augmentation of the Frequency Response provided by turbine controls and is intended to operate in parallel with turbine controls at frequencies above the frequency where involuntary load shedding is initiated.

Disconnection of load differs from governing in that, for practical purposes, it is unidirectional and irreversible. Also, unlike the primary response of turbines which necessarily lags the governor's detection of speed change by periods ranging up to several seconds, the effect of disconnecting load is immediate. Load is assumed to be disconnected in blocks by underfrequency relays set to operate at a small set of discrete frequencies. There will inevitably be some dispersal of the operation of these relays because of the natural small differences in frequency at different locations in the grid and because of normal variations of relay parameters. Nevertheless, load disconnection can be expected to appear as distinct blocks when viewed on the time scale of turbine primary controls.

Simulations of the simple single area power system model illustrate the relative effectiveness of turbine primary control and load disconnection. We consider that the turbines are operating in such ways that their collective headroom for contribution to Frequency Response is 8, 6, or 4 percent of the connected capacity. This Frequency Response capability is provided in two cases as follows:

- Case A - by 60 percent of the connected capacity - all of which has quick responding primary control
- Case B - by 30 percent of connected capacity with quick responding primary control and 30 percent of connected capacity with slow responding primary control

In addition to its Frequency Response capability provided by primary controls of turbines the system has VLD equal to two percent of its connected capacity; this disconnection capacity is arranged in three equal blocks of 0.0667 percent set to operate at 59.85, 59.775, and 59.7 Hz.

We consider the instantaneous loss of power production equal to 4 percent of the running capacity. This loss of 4 percent of capacity would be beyond what is regarded as credible for a system operating near its day's peak load but surely would be credible in nighttime operation.

3.7.2 Case A Simulations

3.7.2.1 8 percent turbine frequency response capability

Figure 11 shows the frequency trajectories produced by the loss of production in case A where all generation contributing primary response does so quickly and when the collective Frequency Response capability is 8 percent of connected capacity.

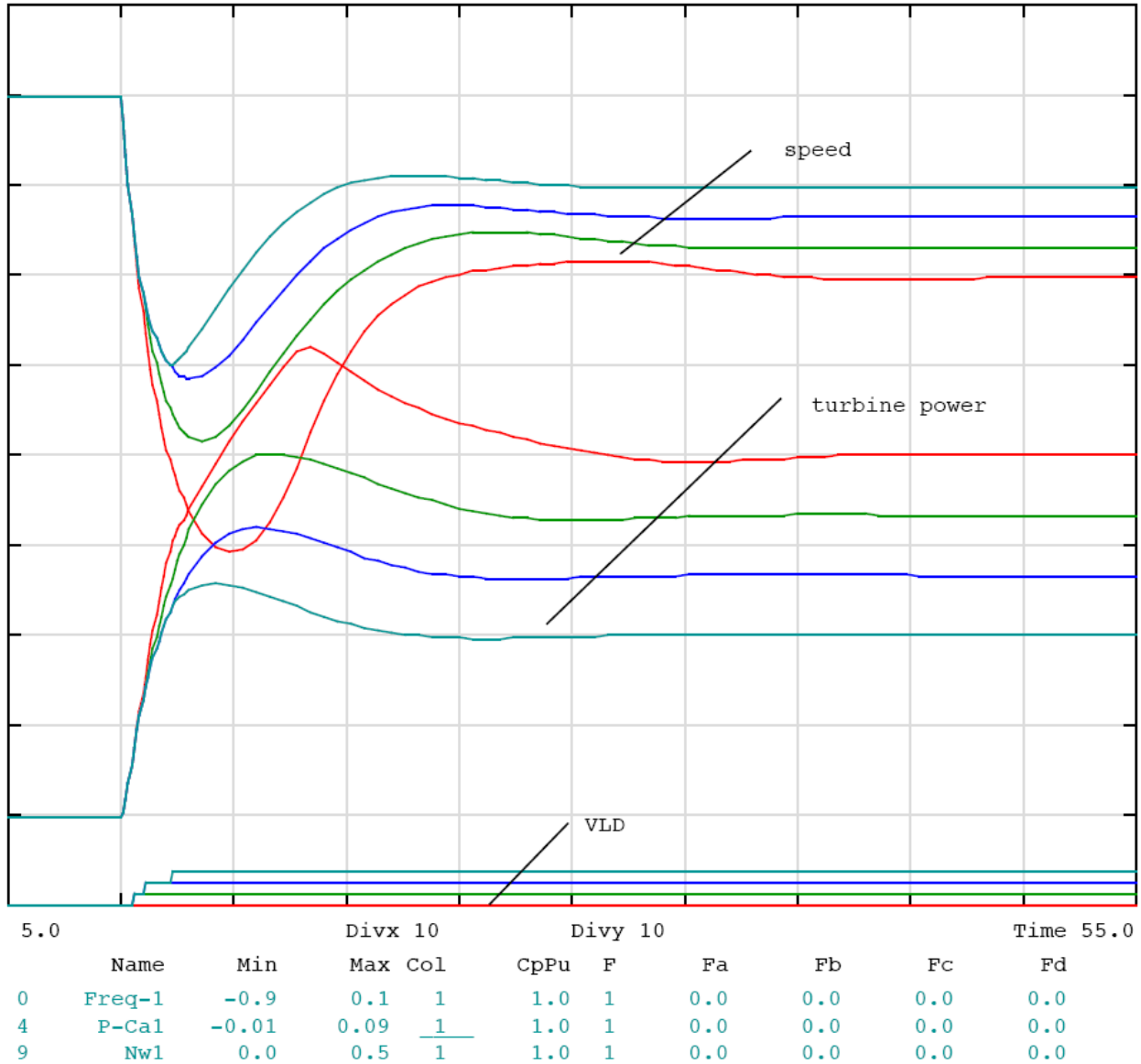

Figure 11. Effect of VLD - 8 pct prompt primary response capability

Four percent generation loss
red no VLD
green 0.667 percent VLD
blue 1.33 percent VLD
cyan 2.0 percent VLD

The red curve in Figure 11 shows the response with no VLD. The settling frequency is 0.2Hz below nominal in exact accordance with equation (1). The cyan curve shows response when the full 2 percent VLD is used and, as a result the required governing response is halved; as expected the settling frequency offset of is exactly half of that seen without VLD.

The green and blue curves show the response when one third and two thirds of VLD are deployed. At these levels of VLD deployment the reduction of load clearly reduces the

requirement for primary response from the turbines but does not shift the system immediately from deceleration to acceleration. Full deployment (cyan curve) produces a decisive shift to acceleration.

It is very important to note that, even though this case has combined turbine and load Frequency Response capability of 2.5 times the lost generation, the nadir of frequency is well below the settling frequency. This is the inevitable result of the inherent delay in the primary response of the turbines.

Figure 11 is a useful reference point for consideration of cases where the reserve of turbine primary control capacity for Frequency Response is less comfortably greater than the loss of production.

3.7.2.2 6 percent turbine frequency response capability

Figure 12 can now be compared with Figure 11 to show the relative value of reserves for primary control response from turbines and reserves of VLD. The red curve of Figure 12 shows that a 6 percent turbine Frequency Response capability, alone, is not sufficient to avoid involuntary load shedding when 4 percent of production is lost; the frequency nadir is at 59.15Hz and involuntary load shedding would surely take place.

With 1.33 percent of VLD (2 blocks out of 3) activated the response in Figure 12 is almost identical to Figure 11. The responses with 6 percent turbine Frequency Response Capability and 2 or 3 VLD blocks are clearly more desirable than that with 8 percent turbine Frequency Response and no VLD.

Even with only one VLD block activated (0.67 percent) the frequency nadir with 6 percent turbine Frequency Response is very close to that shown with 8 percent turbine Frequency Response and no VLD.

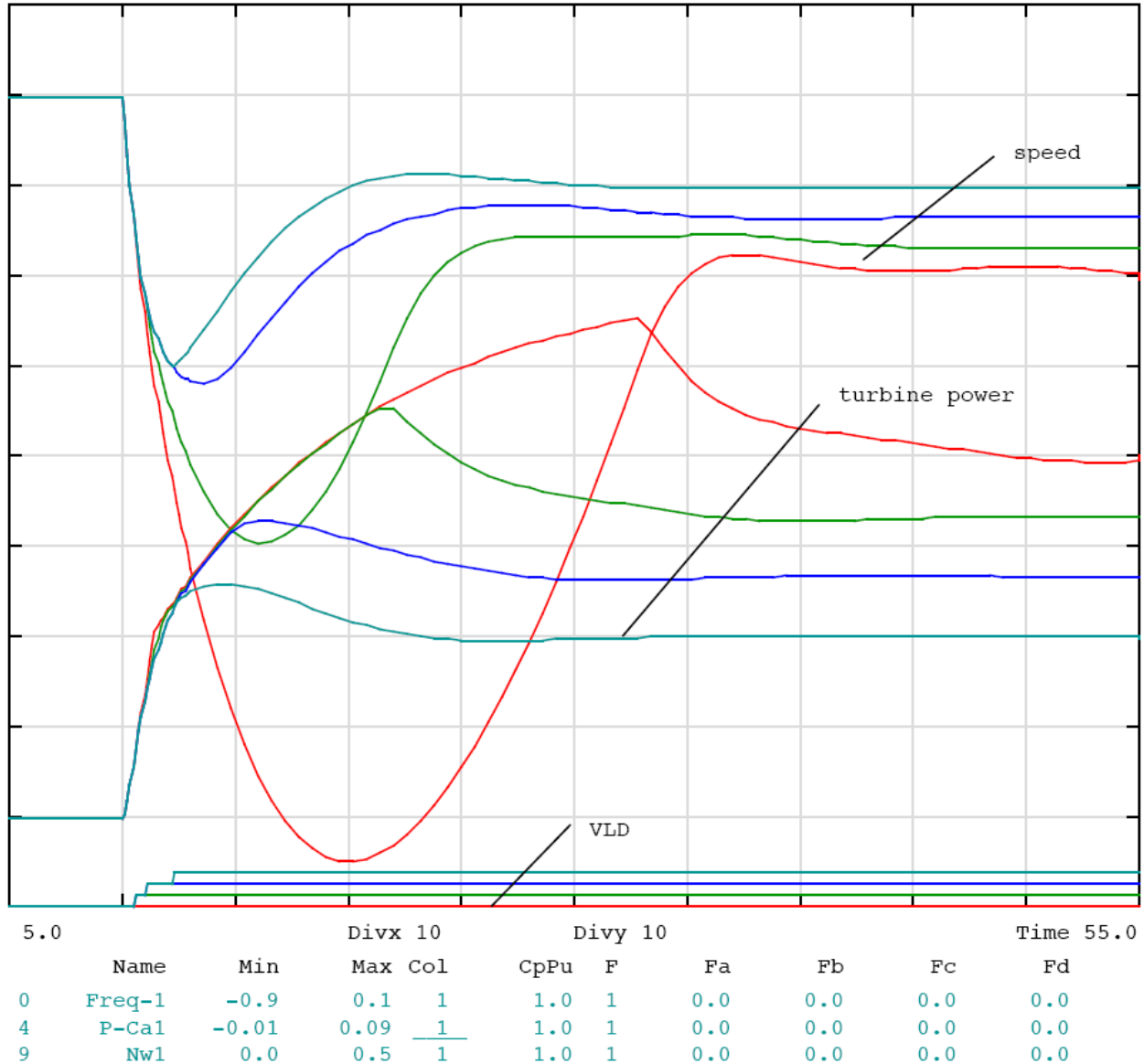

Figure 12. Effect of VLD - 6 pct prompt primary response capability

Four percent generation loss
red no VLD
green 0.667 percent VLD
blue 1.33 percent VLD
cyan 2.0 percent VLD

3.7.2.3 4 percent turbine frequency response capability

Figure 13 shows the responses corresponding to Figure 11 and Figure 12 for the case with turbine Frequency Response capability of 4 percent of connected turbine capacity. As must be the case, the response with no VLD is unacceptable; there is no possibility of an accelerating margin and frequency can drift to an indeterminate low value. A single block of VLD does not

provide a sufficient accelerating margin but two blocks (blue curve) gives a frequency nadir of 59.4 Hz and involuntary load shedding might be avoided.

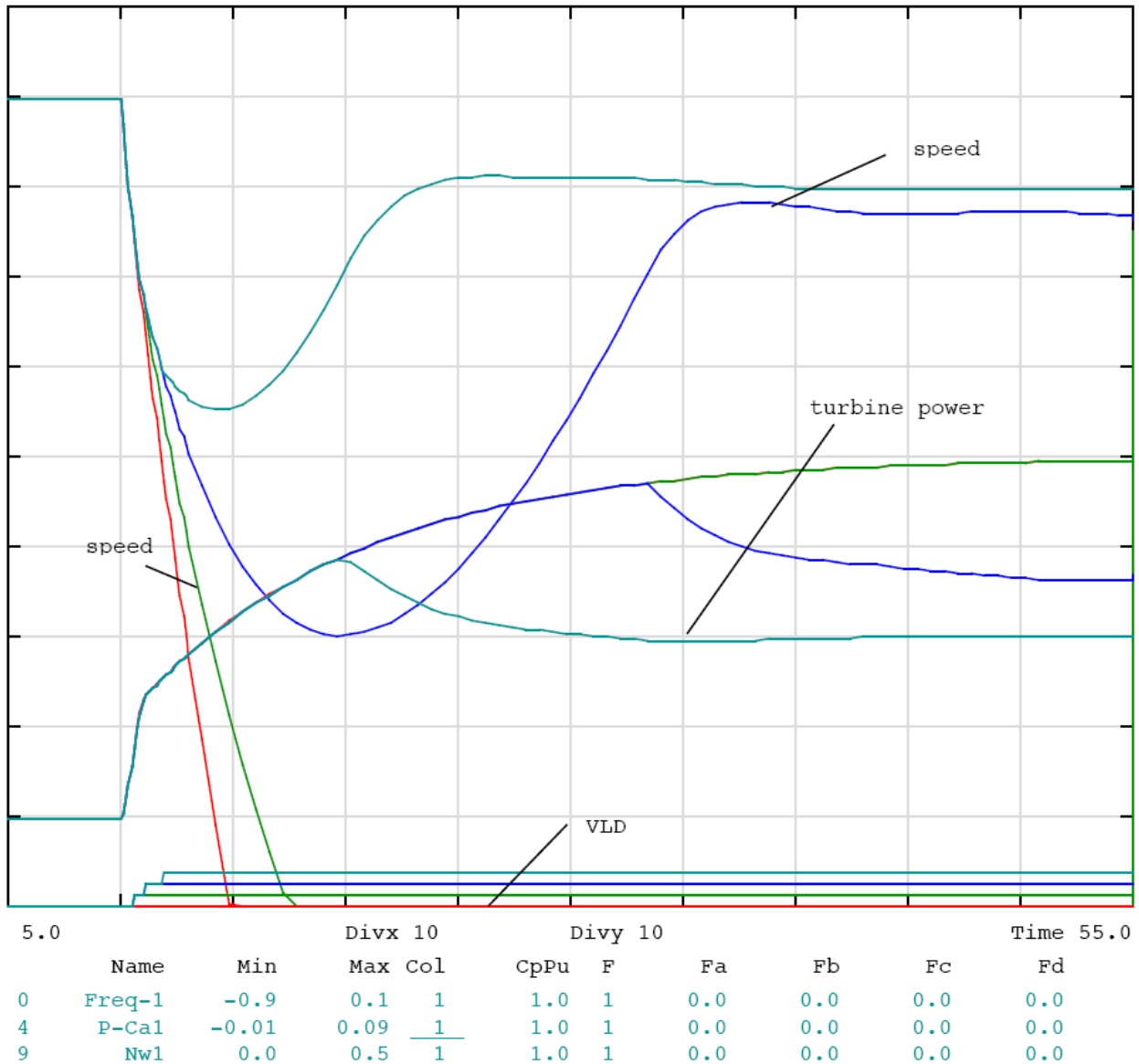

Figure 13. Effect of VLD - 4 pct prompt primary response capability

Four percent generation loss
red no VLD
green 0.667 percent VLD
blue 1.33 percent VLD
cyan 2.0 percent VLD

With the full (2 percent) activation of VLD the frequency nadir is only slightly less than the 59.7 Hz frequency at which the last block is activated.

3.7.3 Case B Simulations

3.7.3.1 8 percent turbine frequency response capability

Figure 14 is similar to Figure 11 but applies for case B in which half of the turbine frequency response is deployed much more slowly than in case A. With this manner of deployment of frequency response the 8 percent turbine frequency response alone is not sufficient to avoid involuntary load shedding and the frequency nadir with one of the three VLD blocks is barely acceptable.

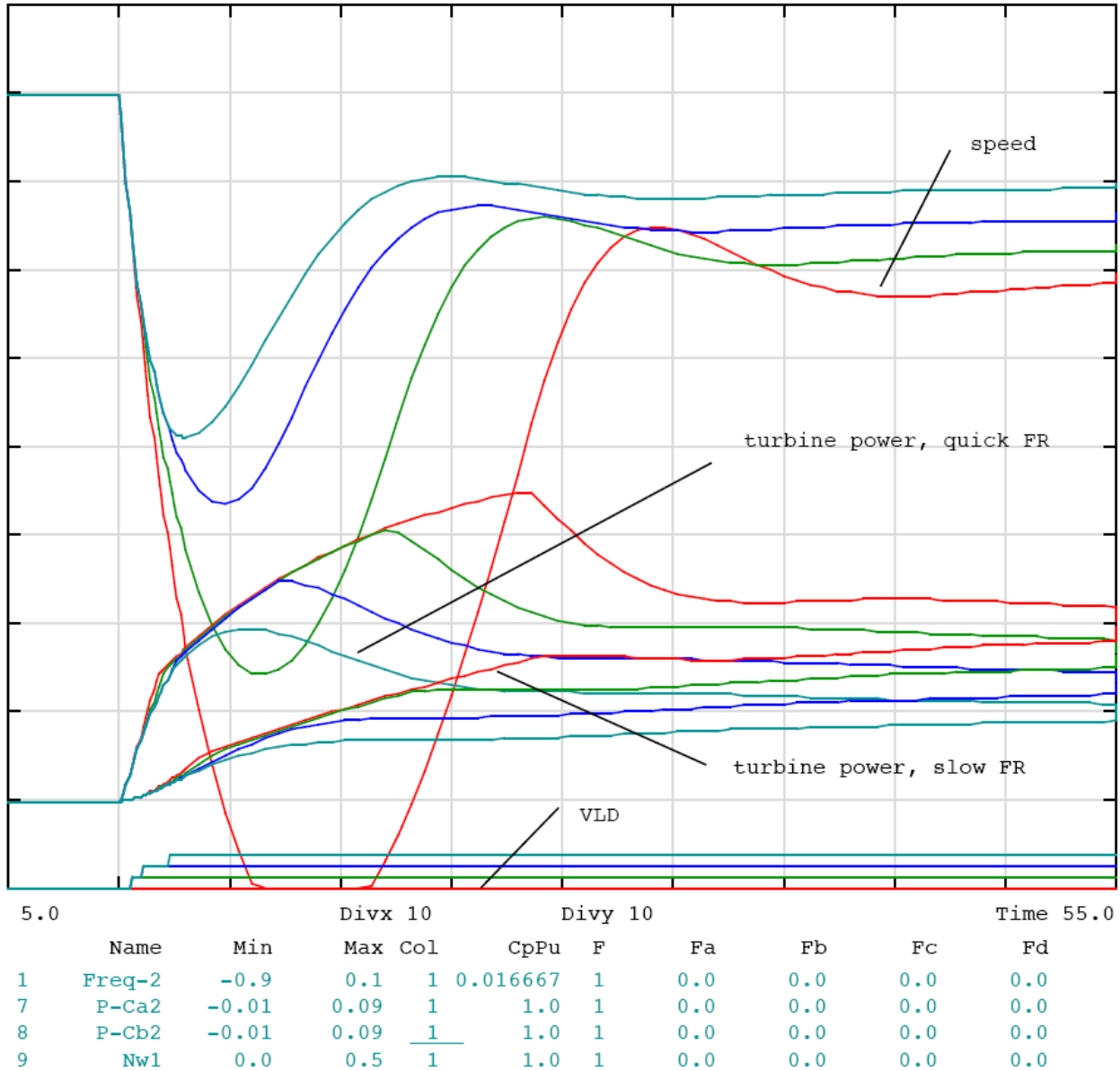

Figure 14. Effect of VLD - 4/4 pct prompt/slow primary response capability

*Four percent generation loss
red no VLD*

green 0.667 percent VLD
 blue 1.33 percent VLD
 cyan 2.0 percent VLD

3.7.3.2 6 percent turbine frequency response capability

Figure 15 shows a barely acceptable frequency nadir with 6 percent turbine Frequency Response and two of the three blocks of VLD.

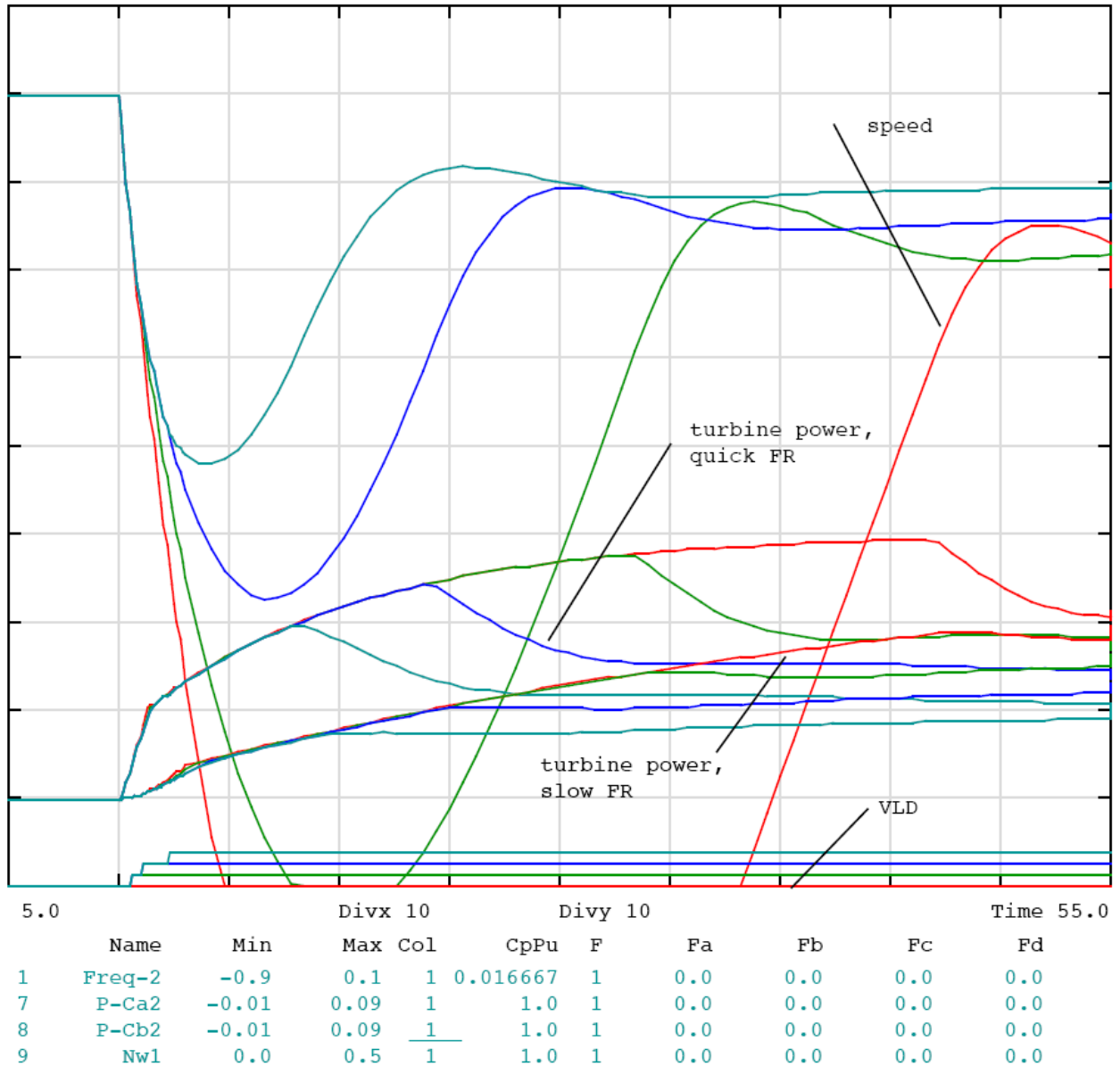

Figure 15. Effect of VLD - 3/3 pct prompt/slow primary response capability

Four percent generation loss
 red no VLD
 green 0.667 percent VLD

blue 1.33 percent VLD
 cyan 2.0 percent VLD

3.7.3.3 4 percent turbine frequency response capability

Even with the full two percent of VLD activated Figure 16 shows that a turbine Frequency Response capability of four percent of connected capacity is inadequate.

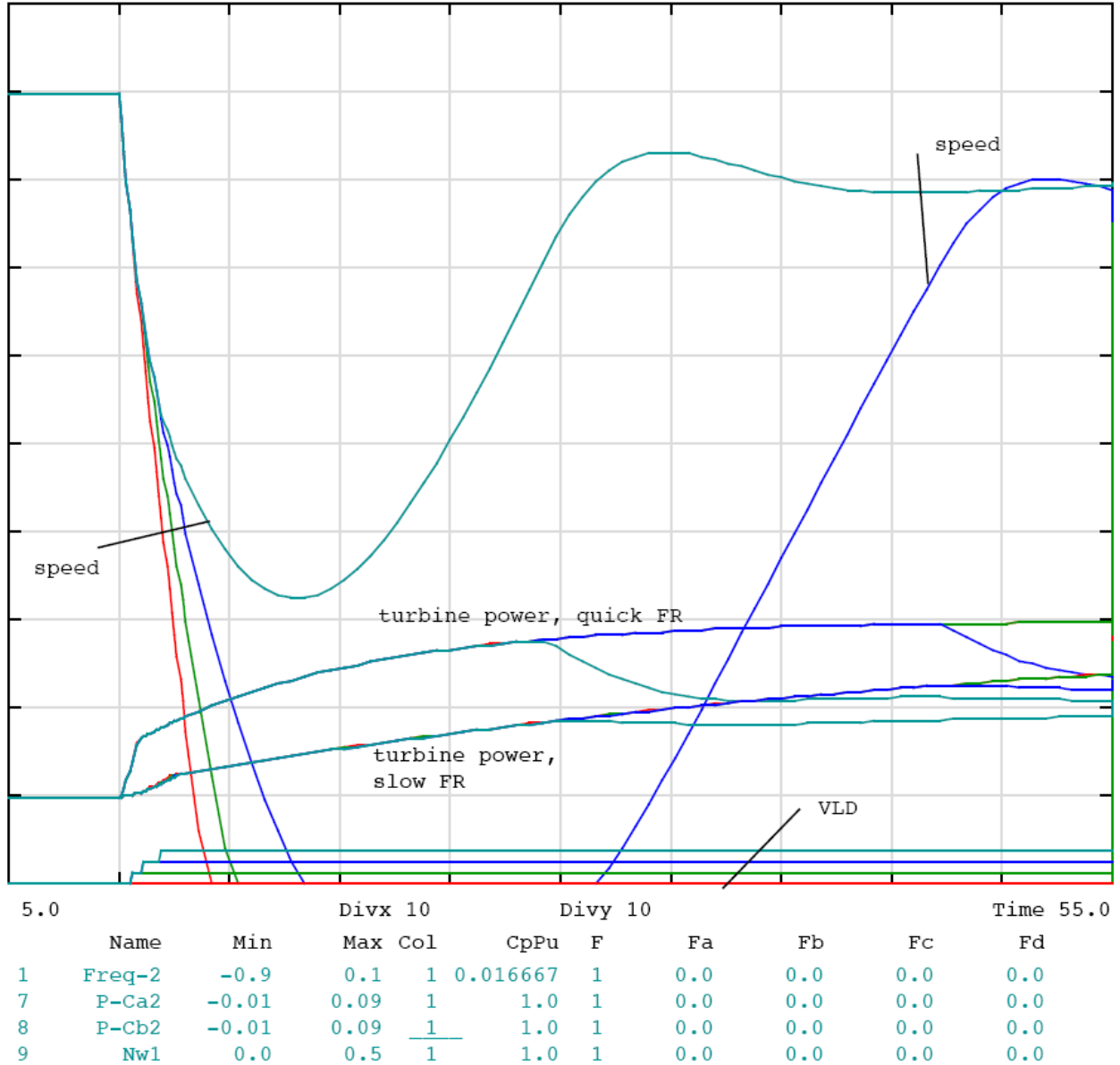

Figure 16. Effect of VLD - 2/2 pct prompt/slow primary response capability

Four percent generation loss
 red no VLD
 green 0.667 percent VLD
 blue 1.33 percent VLD

cyan 2.0 percent VLD

3.7.4 Notes

The simulations shown here, particularly those for case B, are consistent with and emphasize that Figure 9 and Figure 10 make the critical points regarding Frequency Response. A sufficient fraction of the on-line capacity must contribute to primary control in accordance with governor droop, the amount of primary response must be sufficient, and it must be produced in a timely manner. The Frequency Response provided by load is certainly advantageous with regard to timeliness. The unsatisfactory results shown in Figure 16 make it clear, however, that quick response obtained by having a part of the required Frequency Response from voluntary load disconnection does not remove the need for properly prompt response from turbine primary control.

3.8 Transmission Distance in Relation to Frequency Response

It is often asked whether turbines remote from the site of a power-load unbalance will, or should, contribute the same control response as those close to the disturbance site. Intuition suggests that there will be a delay between the occurrence of a disturbance in one corner of the Eastern US grid and its being felt at the opposite corner.

Geographic distance and electrical impedance are not the significant factors in relation to closeness to or distance from the site of a disturbance. Rather, the significant factor is the number of blocks of inertia encountered as one goes from the disturbance site to the point of interest. Figure 17 can be used to illustrate the point. This figure shows a conceptual model of a chain of power system segments in which a disturbance occurring at one end must perturb the segments sequentially before being felt at the far end. In highly simplified form, this small system model can illustrate the delay that would be expected to occur between a generator tripping in Florida and its effect being felt in Minnesota, for example.

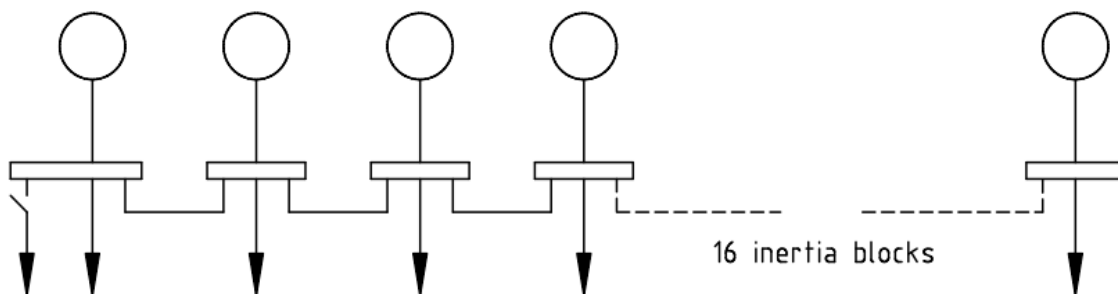

Figure 17. Chain-form power system model to show propagation of disturbance through multiple blocks of inertia

Figure 18 and Figure 19 show how a trip of generation at the left hand end of the chain would be felt at points along the chain towards the right. The speeds of the turbines certainly do not decline equally at the beginning of the event; the delay between the frequency dip at the left and right hand nodes is readily apparent. Nevertheless, the collective speed of the system clearly

does follow the form predicted by the microcosm models and shown in Figure 4 through Figure 7. More importantly, Figure 19 shows that while there is a delay of slightly less than 2 seconds between the initiating generator trip and the beginning of the power increase of the farthest turbine, the differences between the responses of the near and far turbines are minimal. Being separated from the site of the initial capacity loss does not prevent the distant turbines from feeling the event and hence does not prevent them from responding to it.

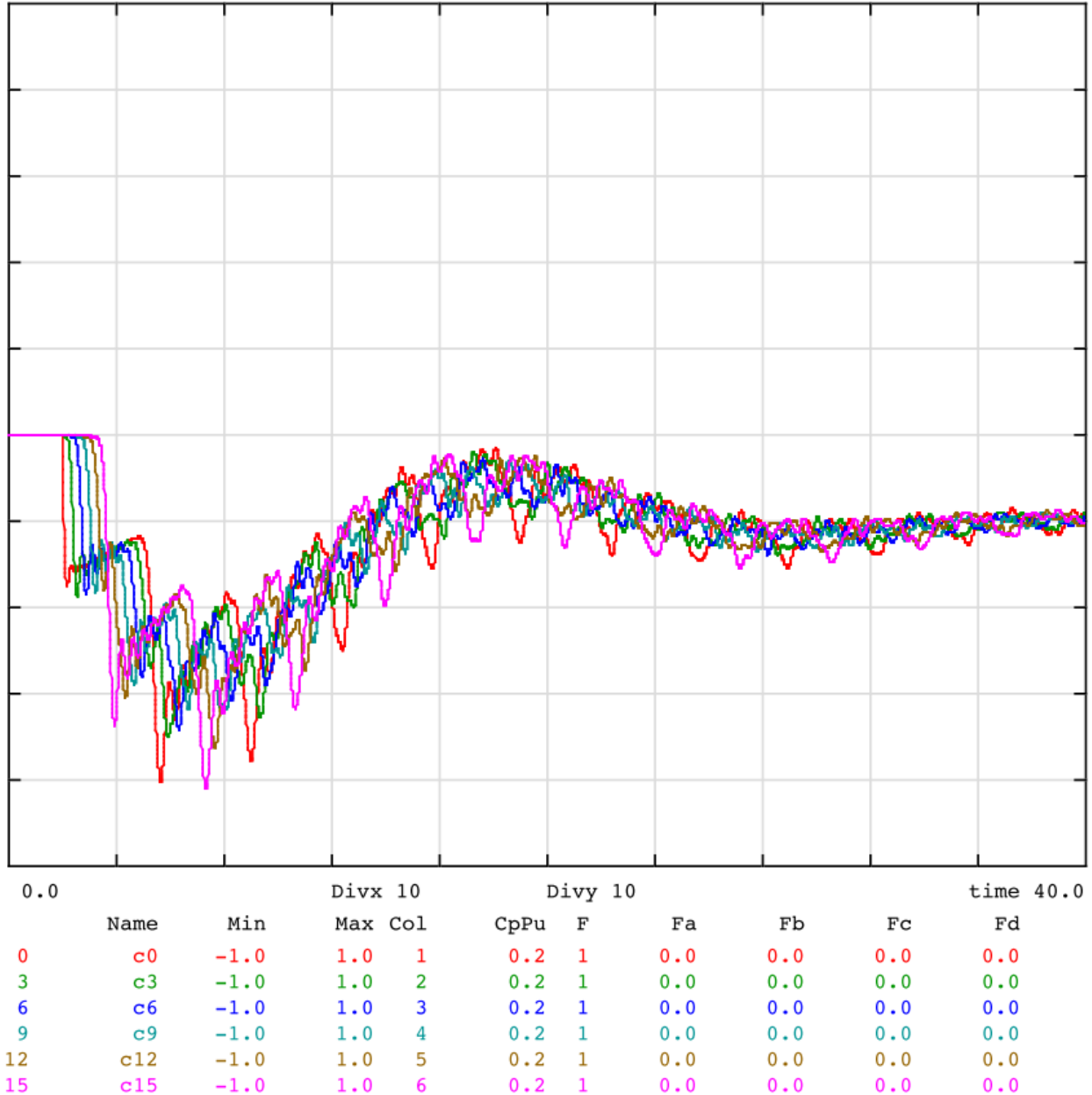

Figure 18. Frequency deviations along a chain-form power system model in response to a generation trip at one end of the chain

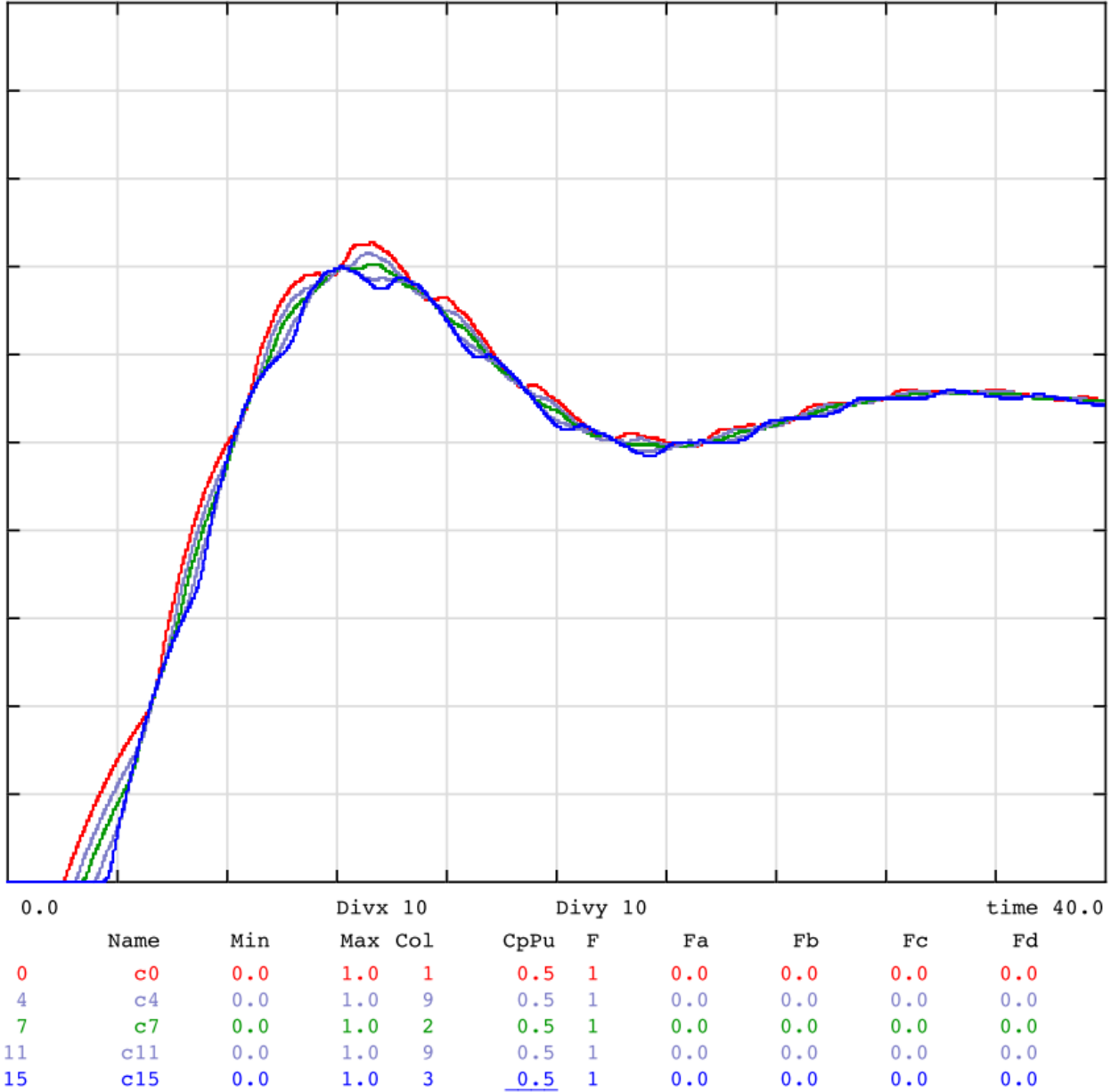

Figure 19. Primary power response of turbines along the chain-form system to a generation trip at one end

The simple chain model of Figure 17 is an exaggeration of the distributed form of the real system and exaggerates the 'propagation' effect. Figure 20 shows a response from a full-scale simulation of the WECC grid. The speeds of turbines located along the full length of the grid are shown for the trip of a large generator in the south. The delay before the northernmost turbines feel the event is readily seen but it is clear that the collective response follows the form predicted by the microcosm model, that both near and far turbines feel the disturbance fully, and hence that all can contribute to the collective response.

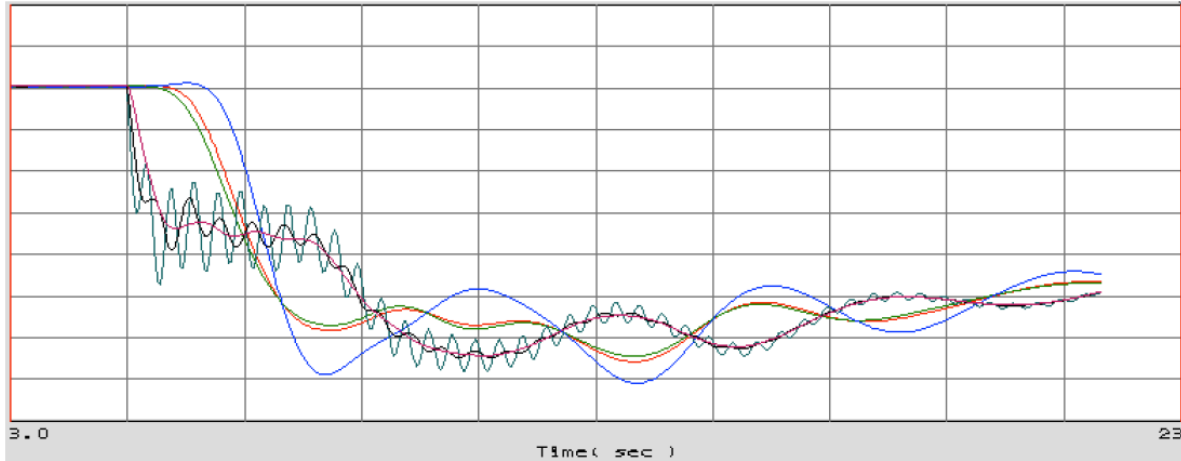

Figure 20. Typical simulated response of WECC system frequencies to loss of generation

With respect to frequency control, it is favorable that turbines throughout the grid can respond to an unbalance of load and generation. However, it is essential to recognize that primary response by turbines that are not adjacent to the site of the unbalance changes transmission loadings. It is essential that transmission flows in normal conditions be kept within limits that allow for the changes in flow that primary response will impose. This, in turn, requires the grid operator to be able to exert secondary control over turbines, both to maintain proper pre-event transmission flows and to reposition generation in appropriate ways after primary response has taken place.

4. Secondary Control – Sudden Events

4.1 Sudden Load-Generation Unbalance

We now turn attention to the small system of Figure 2 when a block of generation of one of the BAs is tripped. This asymmetric event causes the frequency of the interconnected system to dip in the manner covered in the previous discussion and adds additional factor of the power flow on the tie line between the two areas. We consider the case where the capacity of the tie is quite small in relation to the capacities of the BAs that it connects. The example considered here is roughly representative of the configuration of the western side of the WECC system where two large blocks of generating capacity are connected by a relatively weak transmission path at the California-Oregon state line; the collective capacity of this interconnection is somewhat less than 10 percent of the capacities of the generation complexes it connects.

The response of the interconnected systems to this disturbance for the first 10-20 seconds is determined by primary control action. Secondary control action by the LFC systems of the two BAs then should restore the interconnected system to nominal frequency and the tie line flow to scheduled value.

The fractions of type A and type B turbine capacity in each BA are variables in the following examples.

The type A quick responding generation block is modeled by setting parameters in the turbine governor transfer function of Figure A- 3 to

$$T_c = 0.5 \qquad P_{fa} = 0.3 \qquad T_b = 10.0$$

The type B slow responding generation block is modeled by setting parameters in the turbine governor transfer function of Figure A- 3 to

$$T_c = 2.5 \qquad P_{fa} = 0.1 \qquad T_b = 40$$

Table 1 below summarizes the variables and notations used in this report.

Table 1. Summary of Variables

Red	Frequency of BA1	Red	Power flow BA1 to BA2
Blue	Frequency of BA2		
Red	Block A power output, BA1	Red	Block A power output, BA2
Blue	Block B power output, BA1	Blue	Block B power output, BA2

Red	Total incremental power output, BA1	Red	BA1 Area Control Error
Blue	Total incremental power output, BA2	Blue	BA2 Area Control Error

4.2 Load Frequency Control

Figure 21 and Figure 22 show the response of the microcosm system of Figure 2 to the sudden disappearance of generation in BA2. A generation trip in BA2 deprives it of 4 percent of its power production. This is a loss of 2 percent of the total production of the interconnected system. Each BA has 20 percent of its turbine capacity in each of the two responsive types (A and B).

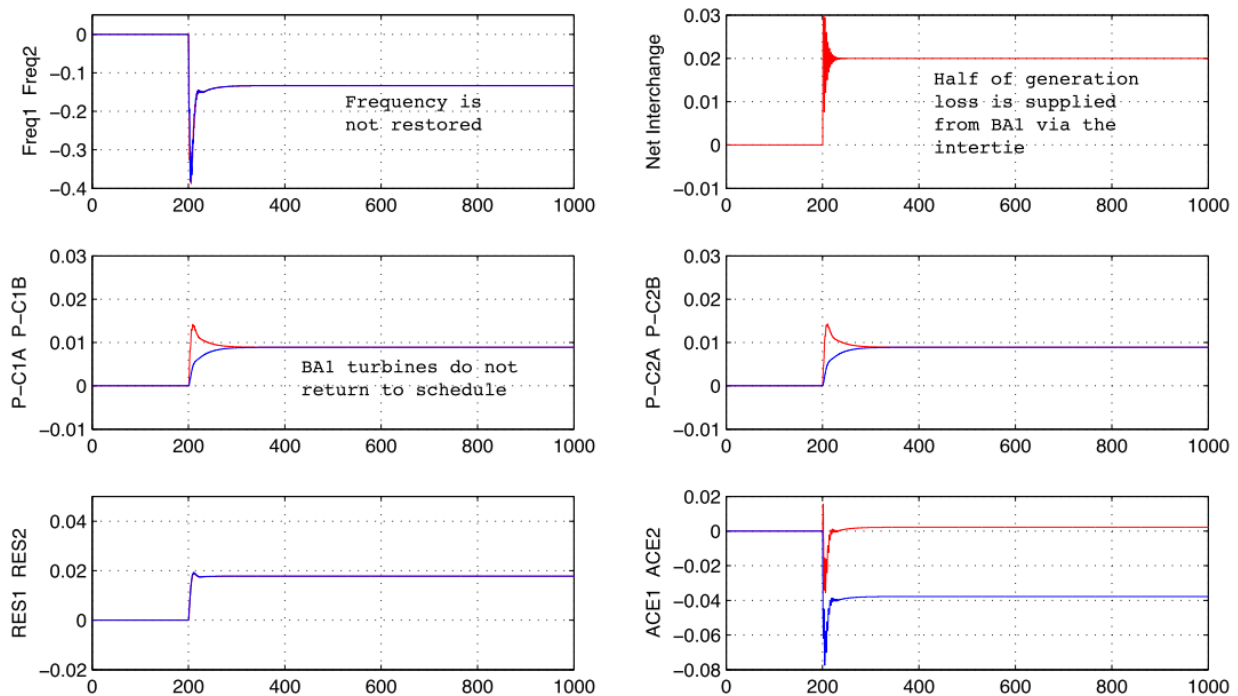

Figure 21. Simulation of two area systems – no LFC action

Balancing area 2 loses 0.04 per unit generation

0.2 per unit of balancing area 1 capacity is type A

0.2 per unit of balancing area 1 capacity is type B

0.2 per unit of balancing area 2 capacity is type A

0.2 per unit of balancing area 2 capacity is type B

Figure 21 shows the response of the interconnected system when there is no secondary LFC action. The plants providing primary frequency response are all operating in simple droop mode. The loss of 2 percent of the system's generation depresses frequency by 0.35 Hz at the nadir and 0.133 Hz in the post-event steady state. The generation increases in the two BAs are equal and

the post event increase in the tie-line flow is two percent of the capacity of BA2. In real terms this simulation corresponds to the loss to roughly 2,000 MW of generation from a 100,000 MW interconnection and an increase of roughly 1,000 MW in tie line flow.

Figure 22 shows simulation of the same event as Figure 21 but with LFC in effect on 40 percent of the turbine capacity in each BA. The frequency deviation at the nadir is essentially unchanged at -0.35 Hz, but in the post-event steady state it has been returned to zero deviation from 60 Hz. Figure 23 expands 50 seconds of the transient to show the tie line oscillation initiated by the asymmetric disturbance.

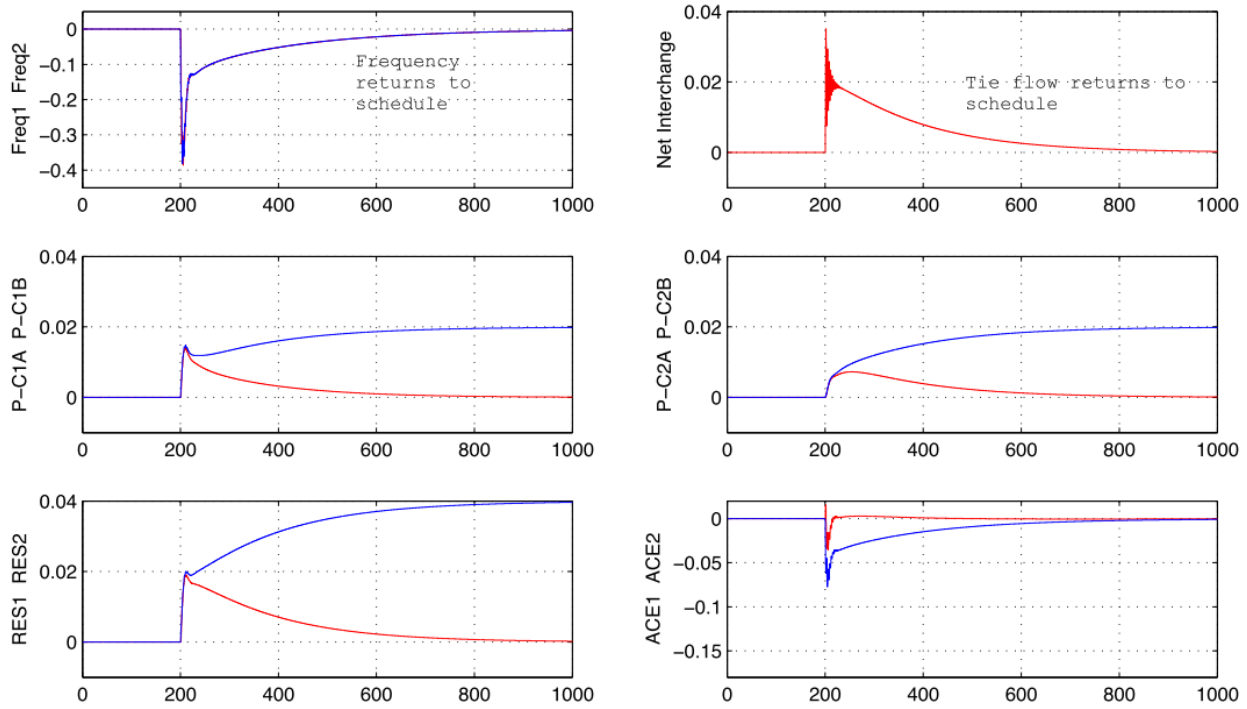

Figure 22. Simulation of two area systems - LFC active in both areas

*Balancing area 2 loses 0.04 per unit generation
 0.2 per unit of balancing area 1 capacity is type A
 0.2 per unit of balancing area 1 capacity is type B
 0.2 per unit of balancing area 2 capacity is type A
 0.2 per unit of balancing area 2 capacity is type B*

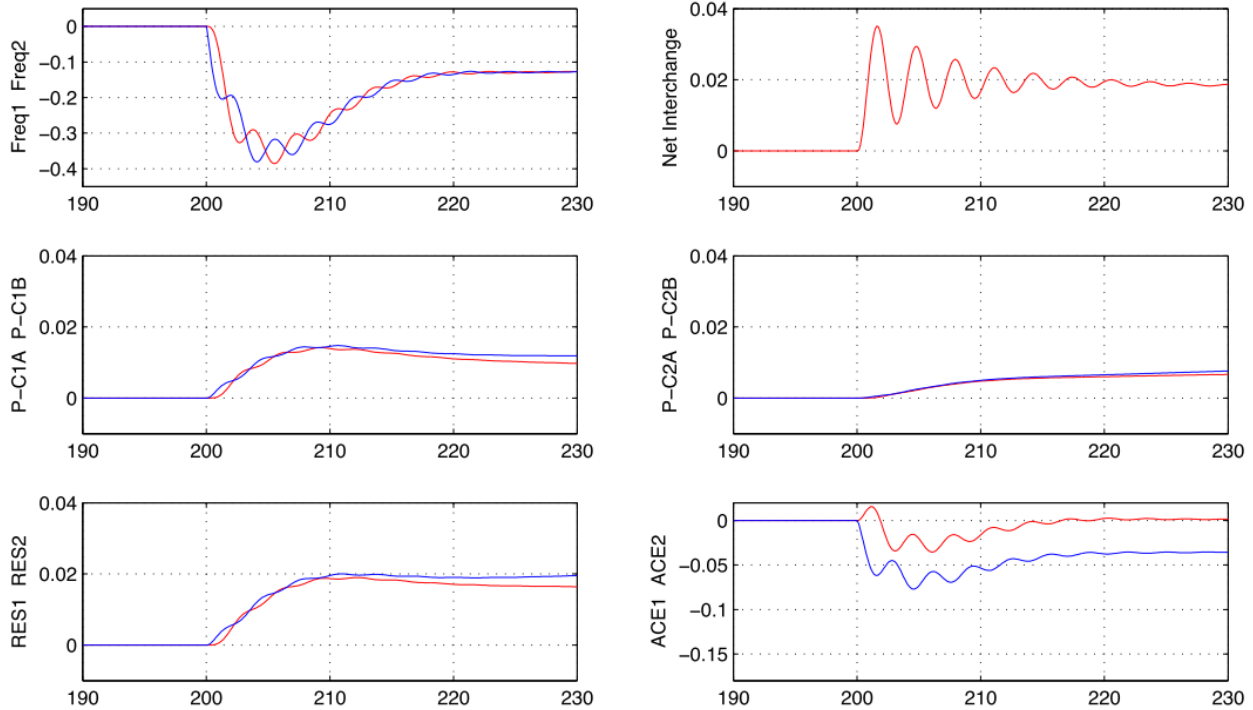

Figure 23. Simulation of two area systems - LFC active in both areas, magnified x-axis

The important result of the secondary control action exerted by the LFC systems of the two BAs is that the power flow on the inter-area tie is returned to its scheduled value in approximately five minutes, thus re-establishing the transmission capacity margin needed to ensure the security of the interconnection. These two simple simulations also emphasize the point that while LFC acts decisively on the time scale of many minutes, it is a slow acting control in comparison to the time scale of the response of frequency to sudden events and has no significant effect on the frequency at which the grid 'settles' when primary control has run its course

4.3 Power Plant Controls (Plant Operation by DCS)

Power plants are operated by Digital Control Systems (DCS). The DCS operates the plant in one of the control modes identified in Section 1.4. In practice plant operators rarely choose simple droop mode and, when asked to run the turbine at a constant output, will normally choose one of the Preselected Load modes. These two operating modes are very different from the viewpoint of the power system.

Figure 24 shows two variations on the simulation shown in Figure 21. In both of these cases 40 percent of the connected turbine capacity is in Preselected Load mode and provides primary response. The remaining 60 percent of capacity in both cases is in non-responsive control modes. There is no LFC. In the first case entire 40 percent of the turbine capacity in Preselected Load mode has its frequency bias set to match the governor droop. In the second only 20 percent of the capacity in Preselected Load mode has its frequency bias active. The simulations show the response to the loss of a turbine carrying 2 percent of the system's total capacity.

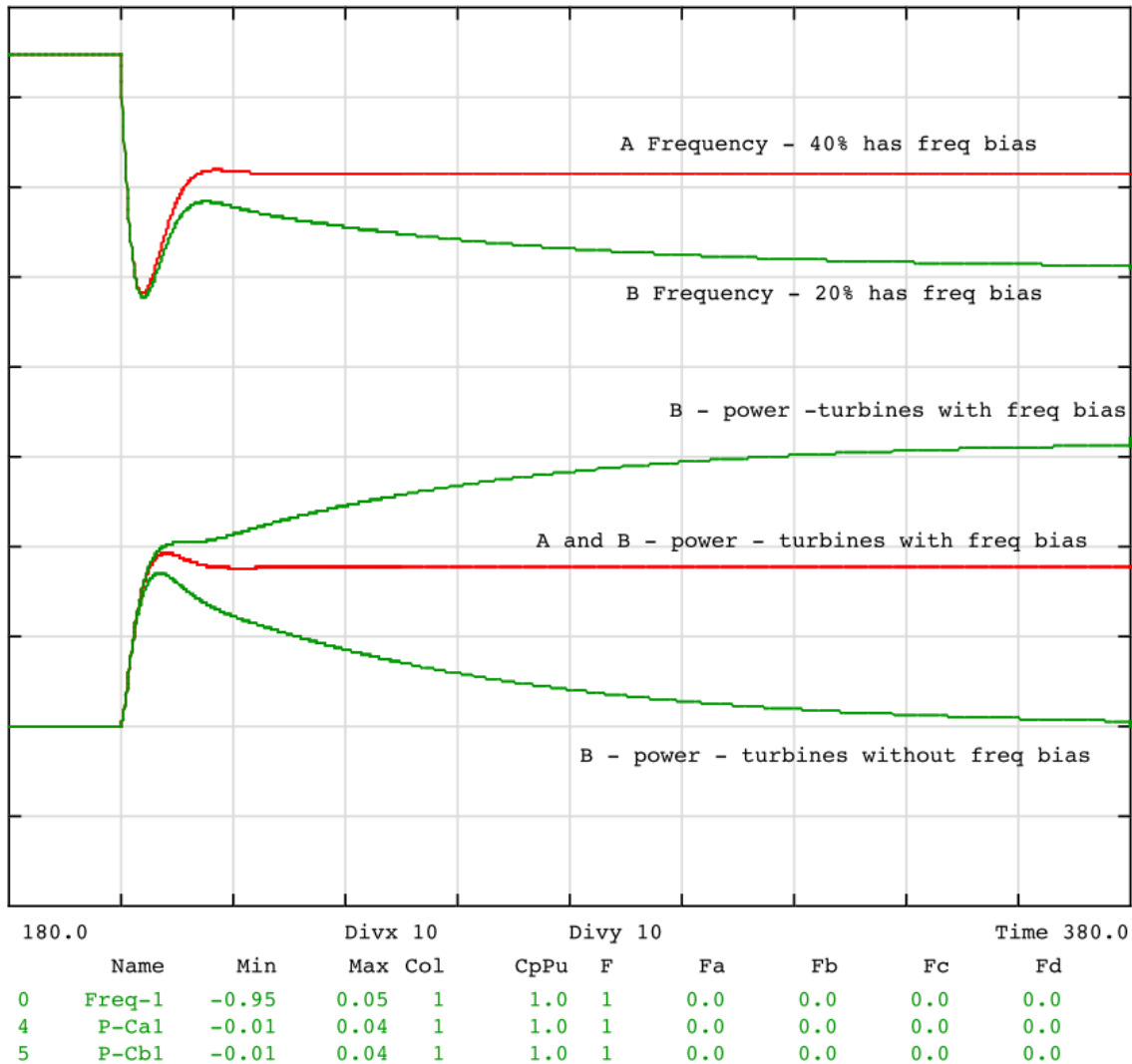

Figure 24. Effect of frequency bias in power plant preselected load control

40 percent of capacity provides primary response while in preselected load mode

Case A All of responsive capacity has frequency bias

Case B Half of responsive capacity has frequency bias

It is seen that:

- the initial frequency dip is the same in both cases but that halving the capacity with frequency bias doubles the deviation of the settling frequency
- the turbines operating in preselected load mode without frequency bias initially provide very nearly the same primary response as when the bias is active but return to the scheduled output in about two minutes

Certainly, providing primary response initially but then withdrawing it is better for the grid than not providing it at all. However it is clear a plant operating in unbiased preselected load mode transfers the task of sustaining a required change in output to other plants.

5. Secondary Control - Ramping of Load and Generation

5.1 Normal Ramping of Load and Pre-scheduling of Generation

The normal ramping of load through the daily load cycle is slow in relation to the rate-of-response capabilities of essentially all generating plants. A typical load-pick-up ramp (early morning or early evening depending on time of year, latitude, etc) would be at a rate of several percent of connected capacity over a period of 1 to 3 hours. The great majority of generating plants (nuclear plants excluded) can ramp their output over their full range at rates of several percent per minute.

The daily cyclic ramping of load is not normally handled entirely by action of the LFC system. In fact, much of the maneuvering of generation needed to follow the daily load profile is scheduled well in advance under a wide variety of commercial arrangements. Many of the day's maneuvers of turbine output are executed in the ten minutes before or ten minutes after the turn of the hour. Each BA schedules maneuvering of generation on the basis of its daily load forecast. In many cases plant operating staff receive their maneuvering schedules well in advance and run their machines accordingly. In these cases the plants are most frequently run in preselected load mode with the load setpoint being a constant or a ramp.

Figure 25 shows a typical daily load forecast and actual load profile for California (3 December 2009). The load increase between 1700 and 1800 hours (as darkness falls) is a ramp of roughly 10 percent per hour.

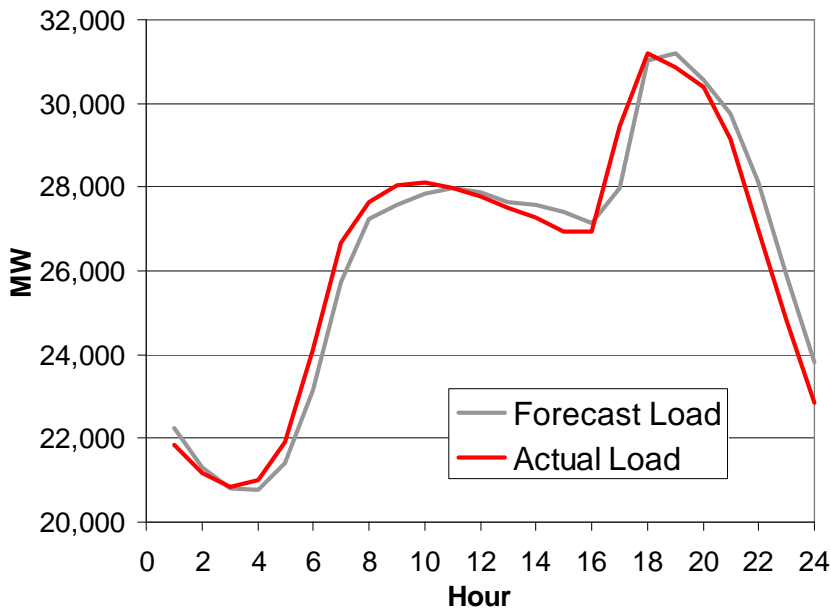

Figure 25. Sample daily load cycle with significant ramp-up of load

Figure 27 through Figure 34 show the trajectories of variables in simulations of a period of 1.5 hours in which both BAs of Figure 2 experience a load increase equal to 10 percent of their connected capacity.

In BA1 the grid operators anticipated the start of the load ramp nearly exactly and pre-scheduled plants totaling 20 percent of the area's connected capacity to increase output at a rate that turned out to be just slightly faster than the load ramp. The ramping of pre-scheduled plants in BA1 was suspended for a period of 10 minutes in the middle of the load ramp. The load ramp started in area 2 ten minutes after it started in BA1. Twenty percent of the connected capacity in BA2 was also pre-scheduled to increase output, but did not start increasing until 10 minutes after the load of BA2 started to increase. The load and prescheduled generation profiles are shown in Figure 26.

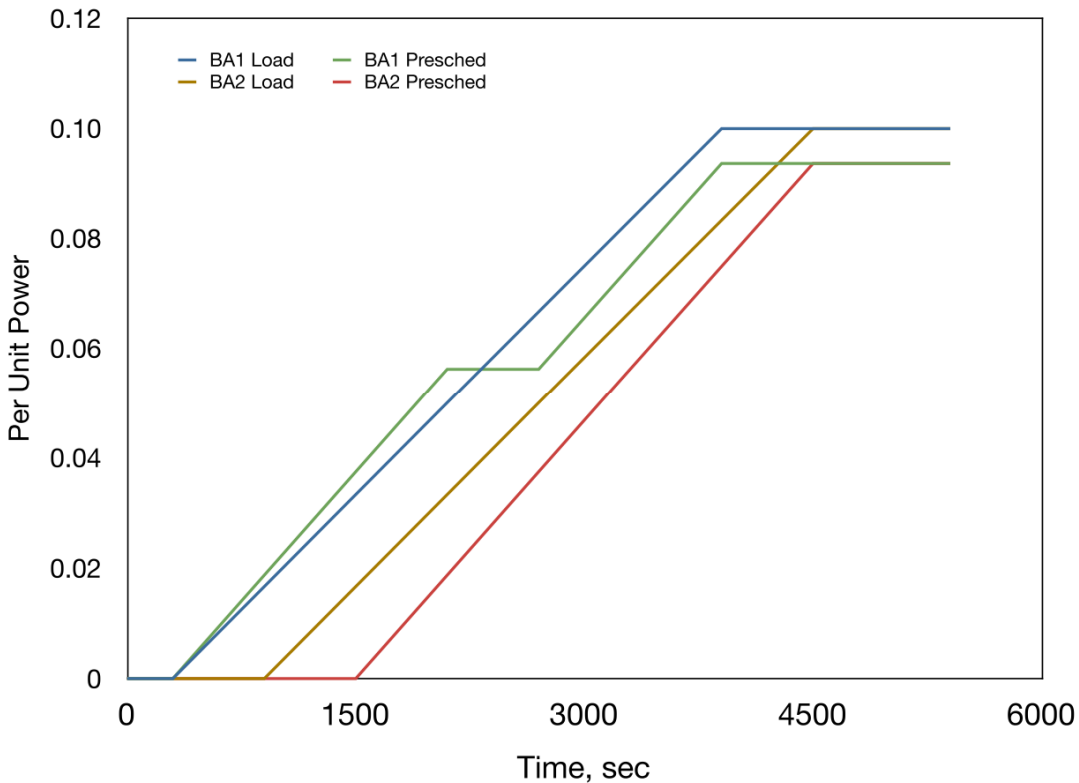

Figure 26. Ramps of load and prescheduled generation for illustrative examples

In addition to generation following prescheduled ramps, each BA had 20 percent of its capacity operating at constant scheduled output in frequency biased prescheduled load mode.

It is normally possible to preschedule generation to match the forecast load profile quite closely but, of course, it is rare that the pre-scheduling achieves an exact match. The continual adjustment of turbine outputs to take care of the imperfection of pre-scheduled generation dispatch is handled by the combined action of primary controls (governing) and LFCs. For the

ramps in these simulations, which are fast in terms of normal 'load following' but slow in relation to the frequency dips caused by sudden losses of generation, it is desirable that the contribution of primary control response be minimal. The secondary control action of LFC systems should provide ideally provide all of the response needed to handle the discrepancy between prescheduled generation output and actual load.

Figure 27 illustrates the behavior of the two BAs in the absence of LFC. All prescheduled capacity was in preselected mode with frequency bias and hence provided sustained primary response. The only secondary control action was the pre-scheduled ramping done by plant controllers. The discrepancies between load and generation were corrected solely by primary response; this resulted in frequency deviations of as much as 79 mHz and caused the flow on the interconnecting path to increase substantially. At the end of the period frequency is 0.045 Hz below schedule.

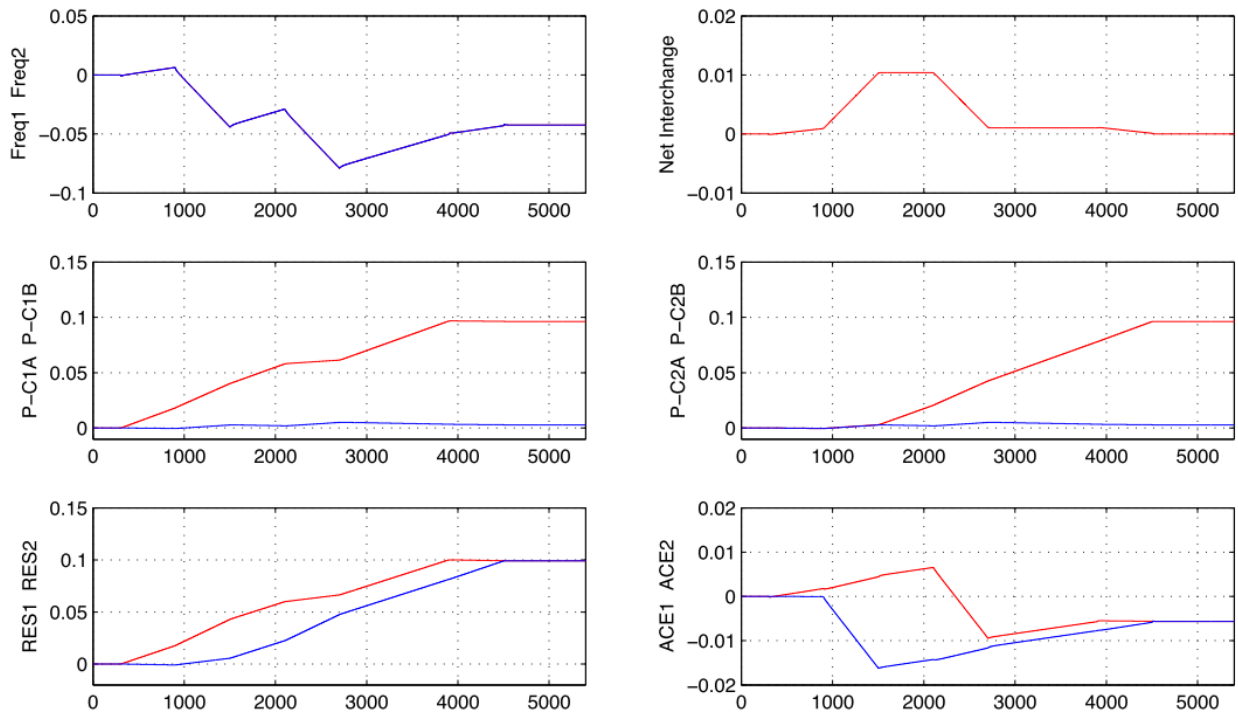

Figure 27. Response to ramps of load in both balancing areas - no LFC action

20 percent of capacity in each BA provides primary response and pre-scheduled ramping of output
20 percent of capacity in each BA provides primary response but no secondary response

Figure 28 corresponds exactly to Figure 27 except that the fraction of connected capacity providing primary response but not secondary response is increased from 0.2 to 0.4. Spreading the primary response requirement, which is the same in both cases, over a larger fraction of the connected capacity reduces the frequency excursions proportionately and has essentially no effect on the deviation of tie line flow from schedule.

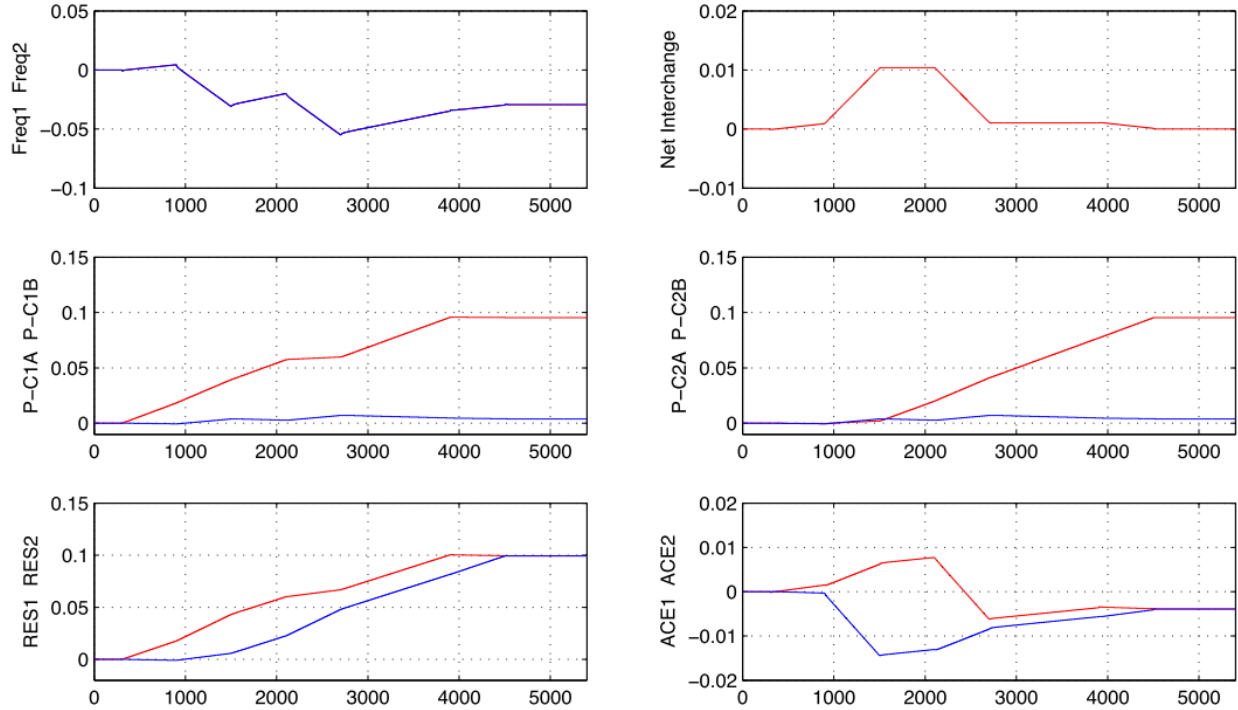

Figure 28. Response to ramps of load in both balancing areas - no LFC action - increased primary control participation

*20 percent of capacity in each BA provides primary response and pre-scheduled ramping of output
 40 percent of capacity in each BA provides primary response but no secondary response*

Figure 29 corresponds to Figure 27 except that LFC is active, sending its commands to 20 percent of the connected capacity in each BA that, for Figure 27, had provided only primary response. The deviations of frequency are approximately one third of those seen without LFC action. The maximum deviations of flow on the interconnection are roughly half of that seen without LFC action. It is notable that the significant reduction in deviations of frequency and interconnection flow are achieved with only small changes in the profiles of load-versus-time followed by the generation that responded to LFC action.

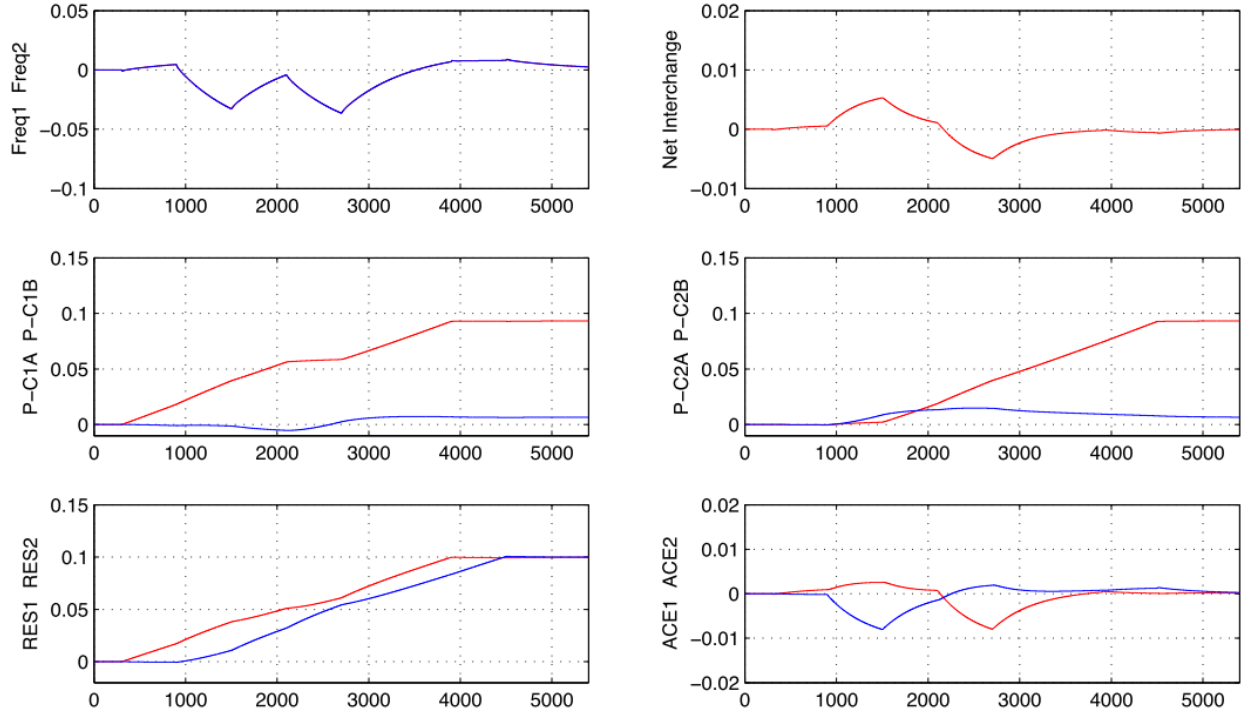

Figure 29. Response to ramps of load in both balancing areas - LFC active

20 percent of capacity in each BA provides primary response and pre-scheduled ramping of output

20 percent of capacity in each BA provides primary response but no secondary response

Figure 30 corresponds to Figure 28 but has 40 percent of its connected capacity responding to LFC. The improvement in control of the interconnected system in comparison to Figure 29 is spectacular; the reason for the improvement is that the doubling of the turbine capacity responding to LFC signals effectively doubles the gain of the LFC system. (Note that the gain of LFC systems is normally set conservatively to ensure that the LFC feedback loop will be stable for wide variations in the amount of turbine capacity responding to LFC commands.)

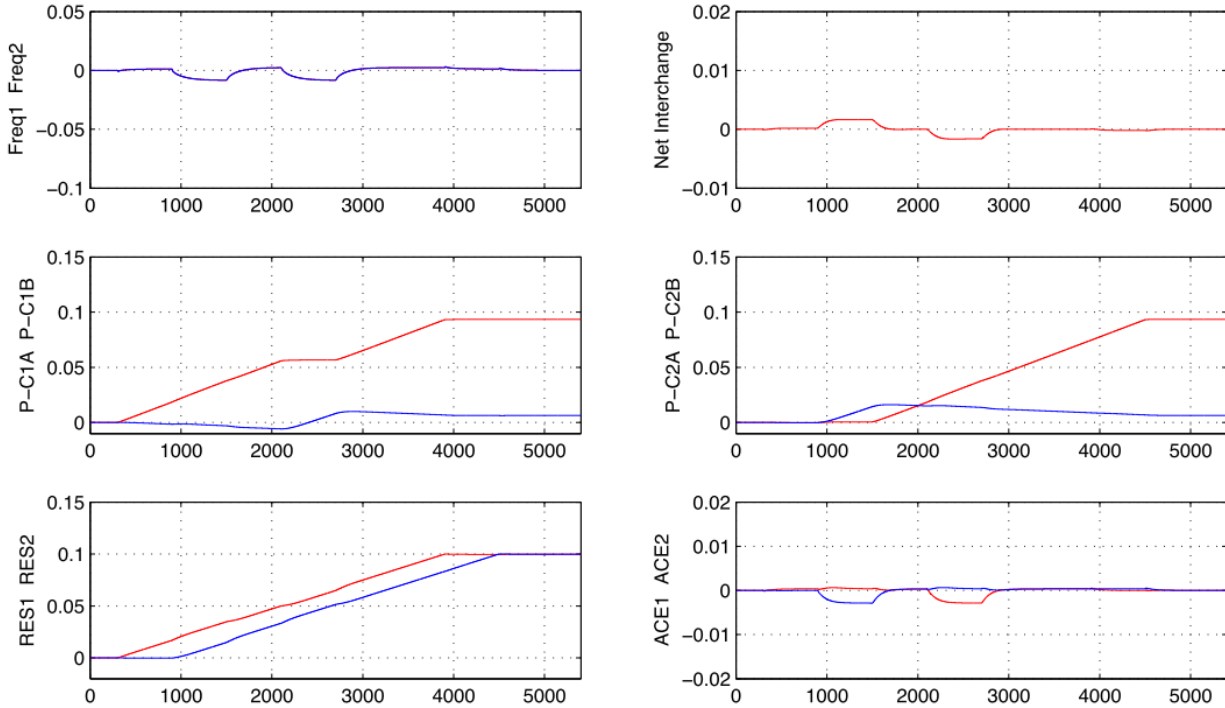

Figure 30. Response to ramps of load in both balancing areas - LFC active - increased primary control participation

*20 percent of capacity in each BA provides primary response and pre-scheduled ramping of output
 40 percent of capacity in each BA provides primary response but no secondary response*

The difference between Figure 29 and Figure 30 is not a complete assessment of how secondary response capability should be allocated. We must now look at Figure 31 and Figure 32.

For the Figure 29 and Figure 30 the turbines providing both primary and LFC response were operating with headroom between their initial and maximum outputs of:

- 7.5 percent of turbine capacity for Figure 29
- 4.0 percent of turbine capacity for Figure 30

With these headroom levels the sum of primary and secondary response called for to correct the imperfection of the pre-scheduled turbine output ramping did not use up the full headroom available.

Figure 31 and Figure 32 show simulations that are the same as shown in Figure 29 and Figure 30 except that the initial headroom levels are:

- 5.0 percent of turbine capacity for Figure 31
- 3.0 percent of turbine capacity for Figure 32

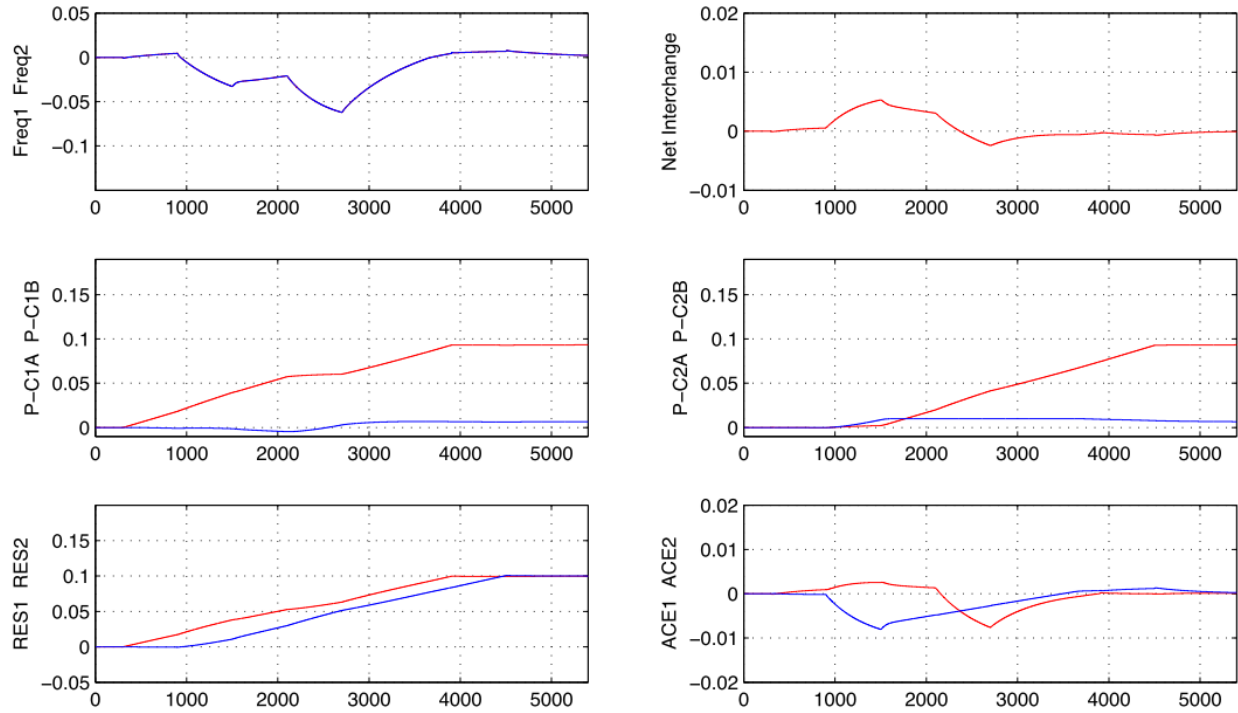

Figure 31. Response to load ramps - Limited primary response headroom - LFC active
20 percent of capacity in each BA provides primary response and pre-scheduled ramping of output
20 percent of capacity in each BA provides primary response but no secondary response

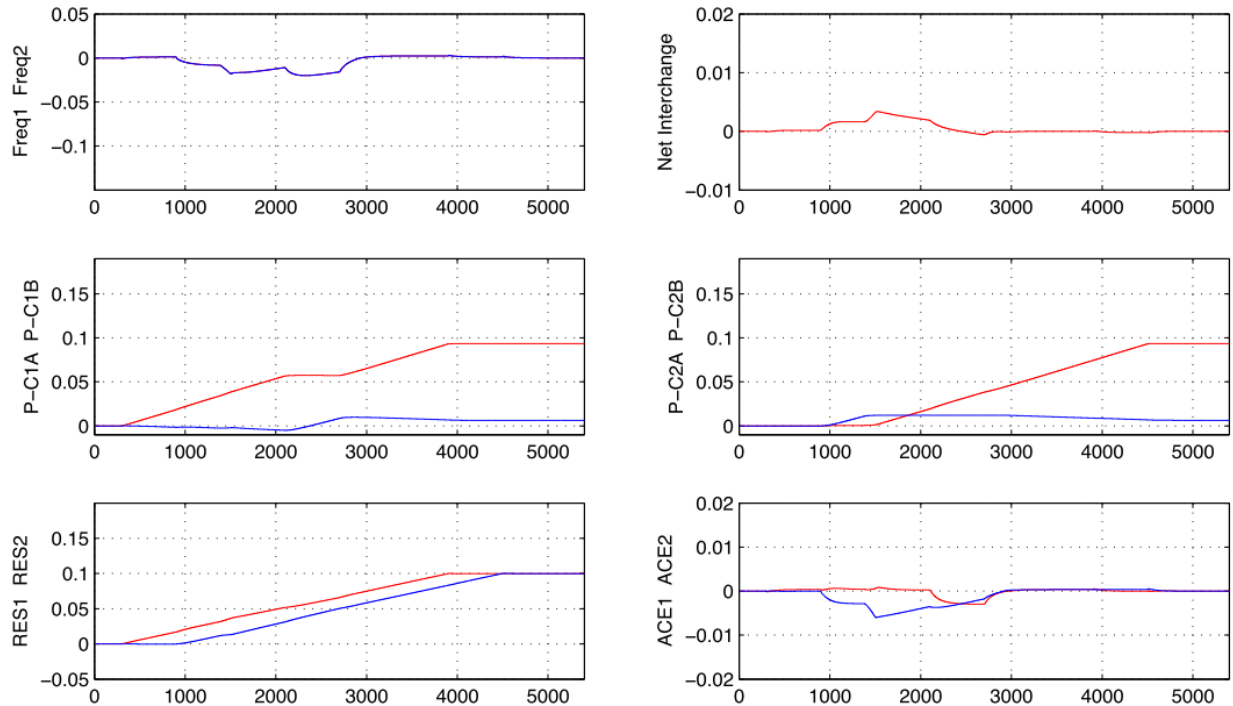

Figure 32. Response to load ramps - Limited primary response headroom - LFC active - increased primary control participation

20 percent of capacity in each BA provides primary response and pre-scheduled ramping of output

20 percent of capacity in each BA provides primary response but no secondary response

With these headroom levels the system does not have enough LFC response capacity to correct the imperfection of the pre-scheduled generation profile. The resulting large frequency and tie flow excursions would have to be corrected by the grid operator revising the load orders to prescheduled plants.

The indication of Figure 27 to Figure 32 is that LFC action must be spread over a fraction of the on line turbine capacity such that:

- the net gain of the load frequency feedback loop is sufficient to drive the secondary control response at the rate needed to handle the discrepancy between prescheduled power production and actual load
- the rates of change of output called for from individual turbines are within their rate of response capabilities
- the collective headroom on the turbines assigned to LFC service is greater than the expected discrepancy between the net load-plus-wind ramp and the prescheduled ramping of generation

5.2 Very Rapid Ramps

The ramping rate of load in per unit of systemwide load is quite gentle in comparison to the ramping rates that turbines can achieve in per unit of their own capacities. Thus, as shown above, the grid as a whole can 'follow' the daily load cycle with far less than all of its connected capacity contributing response.

Ramping of the net unbalance of load and generation at a rate significantly greater than the daily load cycle rates has not been a major concern in large grids until recently. (It is a constant concern in power systems such as isolated industrial sites where the benefits of diversity are much smaller than in large grids.) Unusually fast ramps, often associated with large public events such as the Soccer World Cup final are well understood, anticipated, and prepared for by appropriate allocation of responsive reserves.

It is quite common for a single generating unit to need to ramp its power down or up at the maximum rate that it can achieve. Rapid ramping down is usually associated with trouble in the plant; quick ramping up is increasingly needed to reach a minimum output as quickly as possible after startup in order to comply with air quality requirements. (Stack emissions are usually worst at low output.)

Until recently it has been rare to see so many turbines moving quickly at the same time that the net effect on the grid is troublesome. Recently, though, the European grid has noted that the practice of changing pre-scheduled outputs 'on the hour' has resulted in net ramp rates fast enough to cause unwelcome deviations of frequency. (See reference 5)

The introduction of large amounts of wind generation confronts the grid with a situation that is new with regard to its scale, though familiar with regard to behavior of frequency and power flows. It is now known that the power production of wind plants must be expected, not frequently but often enough to require constant preparedness, to ramp up or down at a rate comparable to the fastest ramping rates of thermal power plants. That is, it must be anticipated that the power output of a wind plant will disappear completely in less than one hour. It is unlikely that the entire wind power output in a large grid will disappear simultaneously at such a rate, but high rates are to be expected within concentrations of wind plants (such as the Tehachapi and Columbia Gorge areas in the WECC system).

In a BA that has a high percentage of its on-line turbine capacity in wind plants the effect of a change of wind must be anticipated to be both rapid and large. Figure 33 and Figure 34 show simulations of the sort of situation that must be anticipated.

The system model is the same as used in the previous section. BA1 initially has 1.0 per unit capacity on line and an area load of 0.8 per unit. It experiences a normal ramp up of load at 0.1 per unit per hour over 70 minutes and its prescheduled ramp up of turbine power matches the load ramp closely for the first 60 minutes. The last 10 minutes of the load ramp take the area load higher than anticipated in the pre-scheduling.

The initial on line capacity in BA2 is 1.0 per unit and its initial load is 70 percent of this capacity. BA2 experiences the same 0.1 per unit per hour ramp up of load, starting 10 minutes after the load ramp starts in BA1. In BA2, however, wind power production disappears at 0.2 per unit per hour concurrently with the ramp up of load. BA2 therefore sees a ramping unbalance between turbine output and load equivalent to a ramp-up of load at 0.3 per unit per hour over a range of 0.3 per unit of the area's total connected capacity. This will take the unused capacity of BA2 to zero at the end of the ramps.

For Figure 33 BA1 has just sufficient generation committed to provide a pre-dispatched turbine ramp up of 0.1 per unit and has headroom provision for 0.1 per unit of LFC response. BA2 (having been forewarned by a short term weather observation) has unloaded turbine capacity equal to 0.2 per unit of its total connected capacity available to be ramped by pre-dispatch order. The predispached ramp starts 10 minutes after the start of the load and wind power ramps. BA2 has headroom on 0.2 percent of its capacity to be able to provide 0.1 per unit of LFC response.

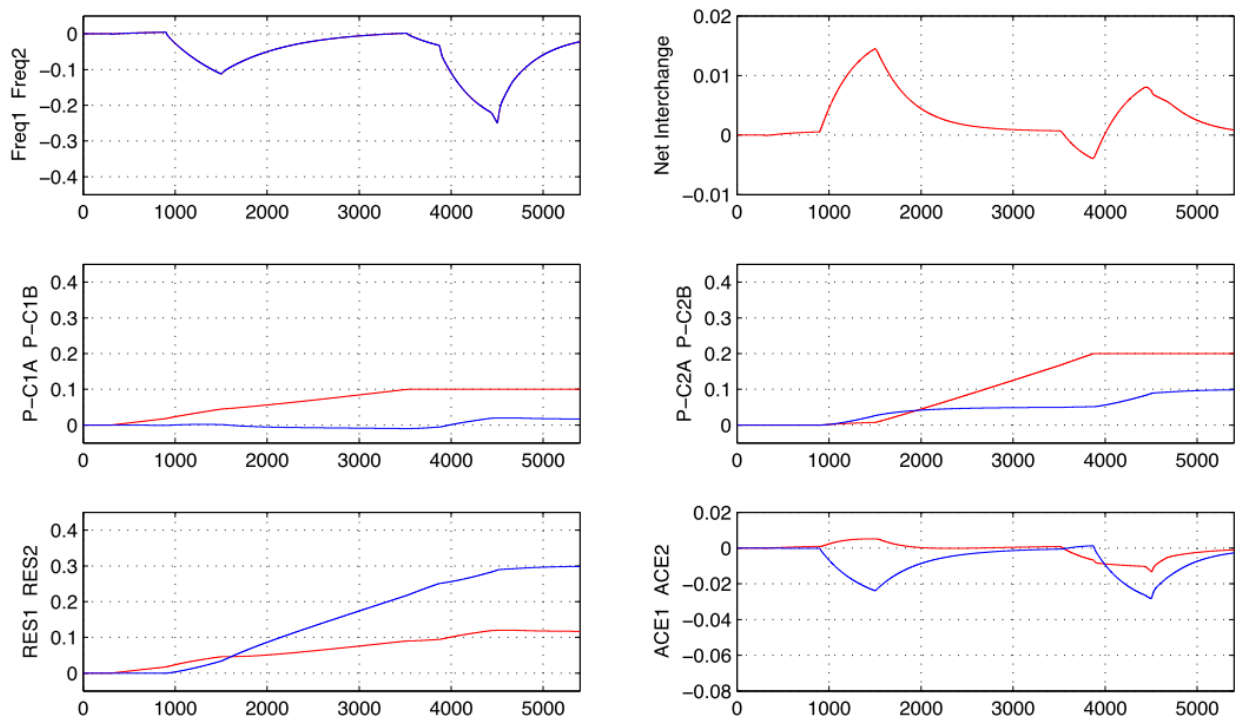

Figure 33. Response to concurrent ramps of load and wind power production - adequate secondary response capability

Load ramps up at 0.1 per unit per hour in both balancing areas

Wind power ramps down at 0.2 per unit per hour in balancing area 2

20 percent of BA 1 capacity can provide 0.1 per unit prescheduled response

20 percent of BA 1 capacity can provide 0.02 per unit LFC response

20 percent of BA 2 capacity can provide 0.2 per unit prescheduled response

20 percent of BA 2 capacity can provide 0.1 per unit LFC response

Figure 33 shows that BA1 handles its load ramp with substantial margin. The response of its LFC generation is a slight decrease until the last several minutes of the event, but turns into an increase when the pre-dispatched generation reaches the end of its ramp. The ACE of BA1 shows a minimal deviation until near the end of the event.

Because the prescheduled generation started *late*, BA2 initially needs assistance from BA1 and there is a large deviation of tie line power flow towards BA2. The frequency and tie flow then return towards scheduled values until BA2 reaches the limits of both its prescheduled ramp capability and its LFC capability. Frequency then dips by 0.24 Hz and the primary-plus-LFC response capability of BA1 is all that is left to restore frequency to schedule. At the end of the simulation the interconnected system is nearly back at scheduled frequency but there is no remaining primary or secondary control capability.

Figure 34 shows the simulation of the same event with the same system conditions except that the limit of the prescheduled ramp up production in BA1 is reduced from 0.1 per unit to 0.09 per unit of connected capacity. The simulated response is the same as in Figure 33 until the prescheduled capacity in BA1 reaches its limit. By the end of the run all prescheduled and LFC-responsive reserves have been deployed and frequency has settled at 0.2 Hz below schedule, after falling as far as 0.35 Hz below schedule. The only possibilities for regaining control of the system are to disconnect load or to start up additional generation.

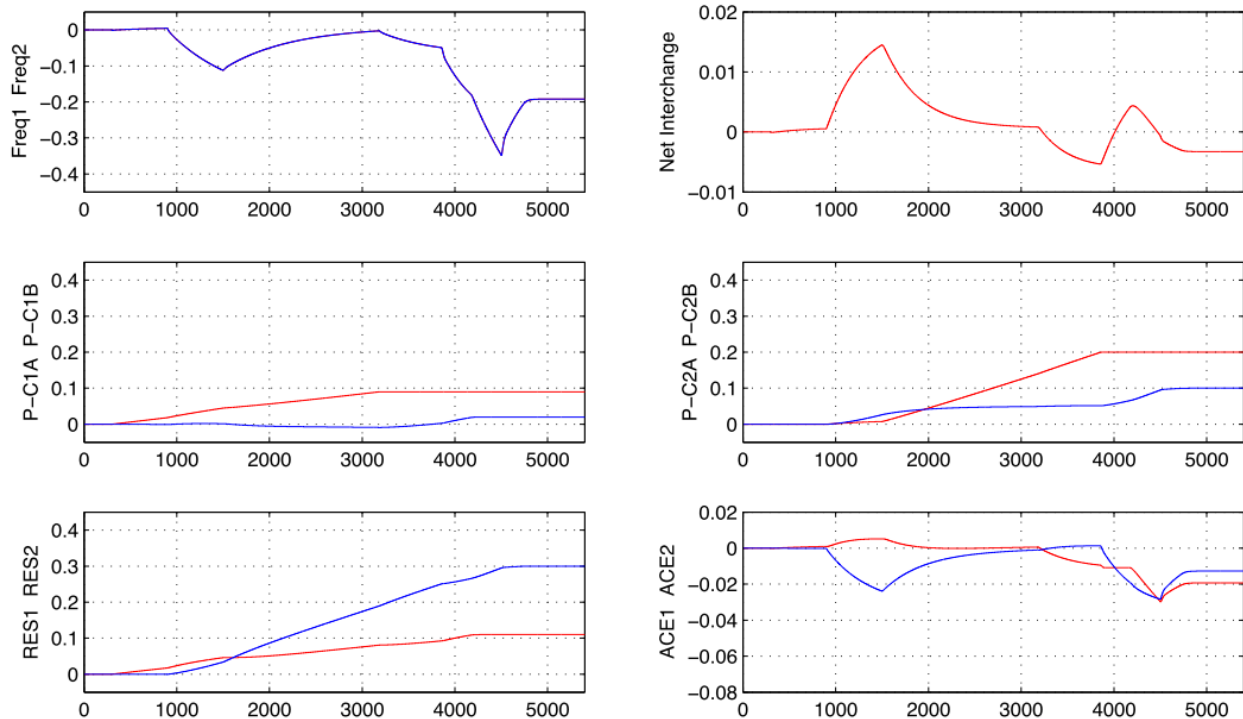

Figure 34. Response to concurrent ramps of load and wind power production - insufficient secondary response capability

*Load ramps up at 0.1 per unit per hour in both balancing areas
 Wind power ramps down at 0.2 per unit per hour in balancing area 2*

Power and Frequency Control as it Relates to Wind-Powered Generation

20 percent of BA 1 capacity can provide 0.09 per unit prescheduled response

20 percent of BA 1 capacity can provide 0.02 per unit LFC response

20 percent of BA 2 capacity can provide 0.2 per unit prescheduled response

20 percent of BA 2 capacity can provide 0.1 per unit LFC response

6. Imperfections and Practical Matters

6.1 Deadband

Deadband in turbine governors is often mentioned as a cause of poor control performance. While it is certainly true that excessive deadband is detrimental to the performance of nearly all feedback controls, it is important to recognize that deadband effects in properly maintained turbine controls are minimal. The prevailing grid codes (such as reference 4) allow a deadband of 0.02 percent in terms of speed and the majority of well maintained equipment can achieve this level. A deadband of 0.02 percent corresponds to a frequency deviation of 12 mHz in a 60 Hz system. This level of deadband surely does affect the accuracy of frequency control in quiescent conditions but it is important to recognize that it is a minor effect in relation to the loss-of-capacity and ramping situations of interest here.

Figure 35, Figure 36, and Figure 37 give a useful indication of the effects of deadband in relation to simulations shown here. Figure 35 compares the simulation shown in Figure 5 when made with and without a deadband of 0.02 percent (Figure 5 was made without deadband). In this case of a fairly small loss of turbine capacity the effect of the deadband is clear but is not a substantial change in the quality of frequency control. Figure 36 shows the same comparison as Figure 35 for the case shown in Figure 6; it shows the response to the same 1 percent loss of turbine capacity when the headroom available for primary response is only just enough to cover the capacity loss. In this situation the governors call for the entire available primary response regardless of deadband and the effect of deadband is negligible. Figure 37 compares the simulation of Figure 22 with and without deadband; here the effect of the deadband is negligible in relation to the action of the LFC system.

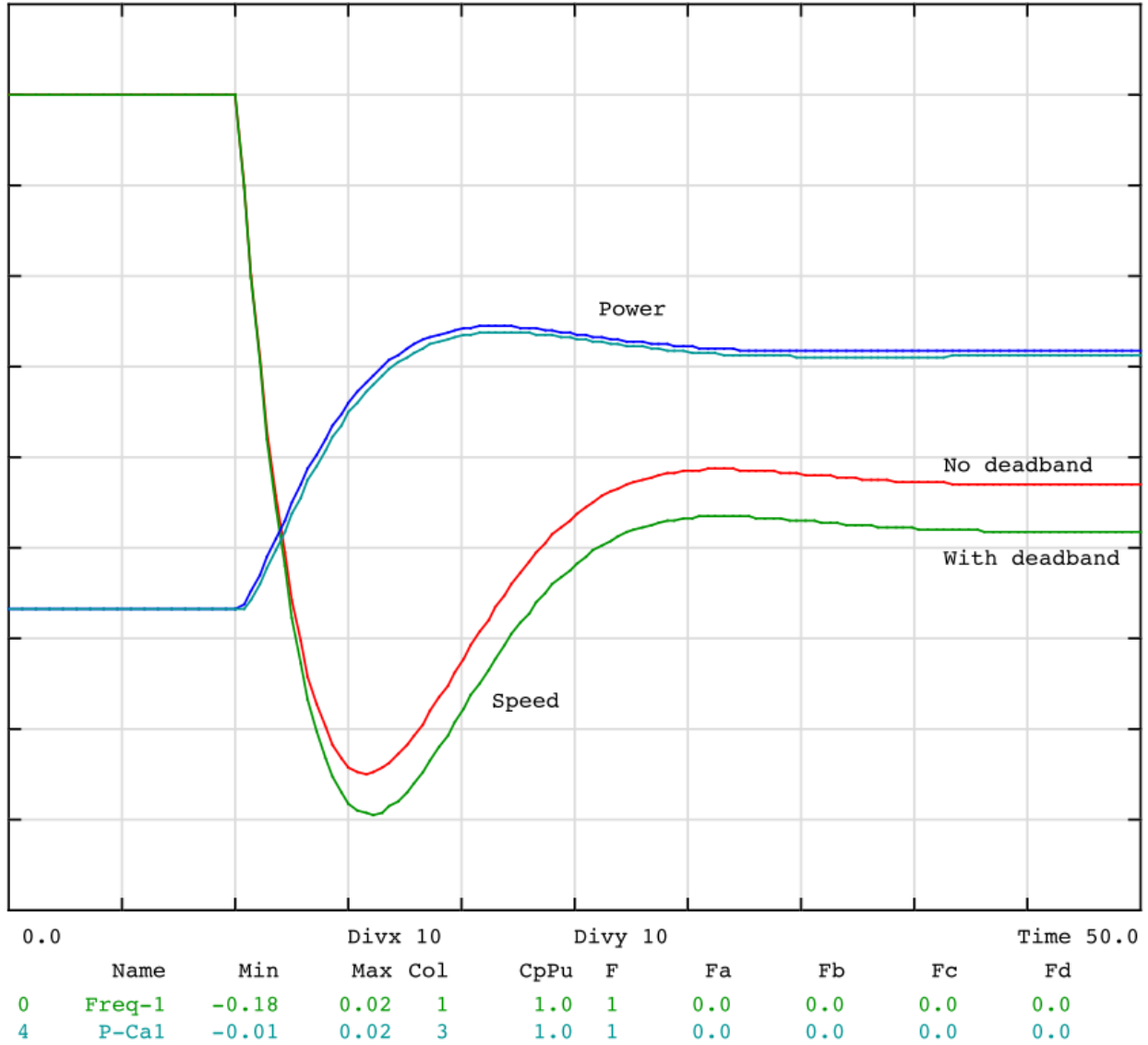

Figure 35. Effect of governor deadband of 0.02 percent speed

*Single area simulation model - 0.01 per unit load increase
 Red - without deadband (same result as shown in figure 5)
 Green - with deadband*

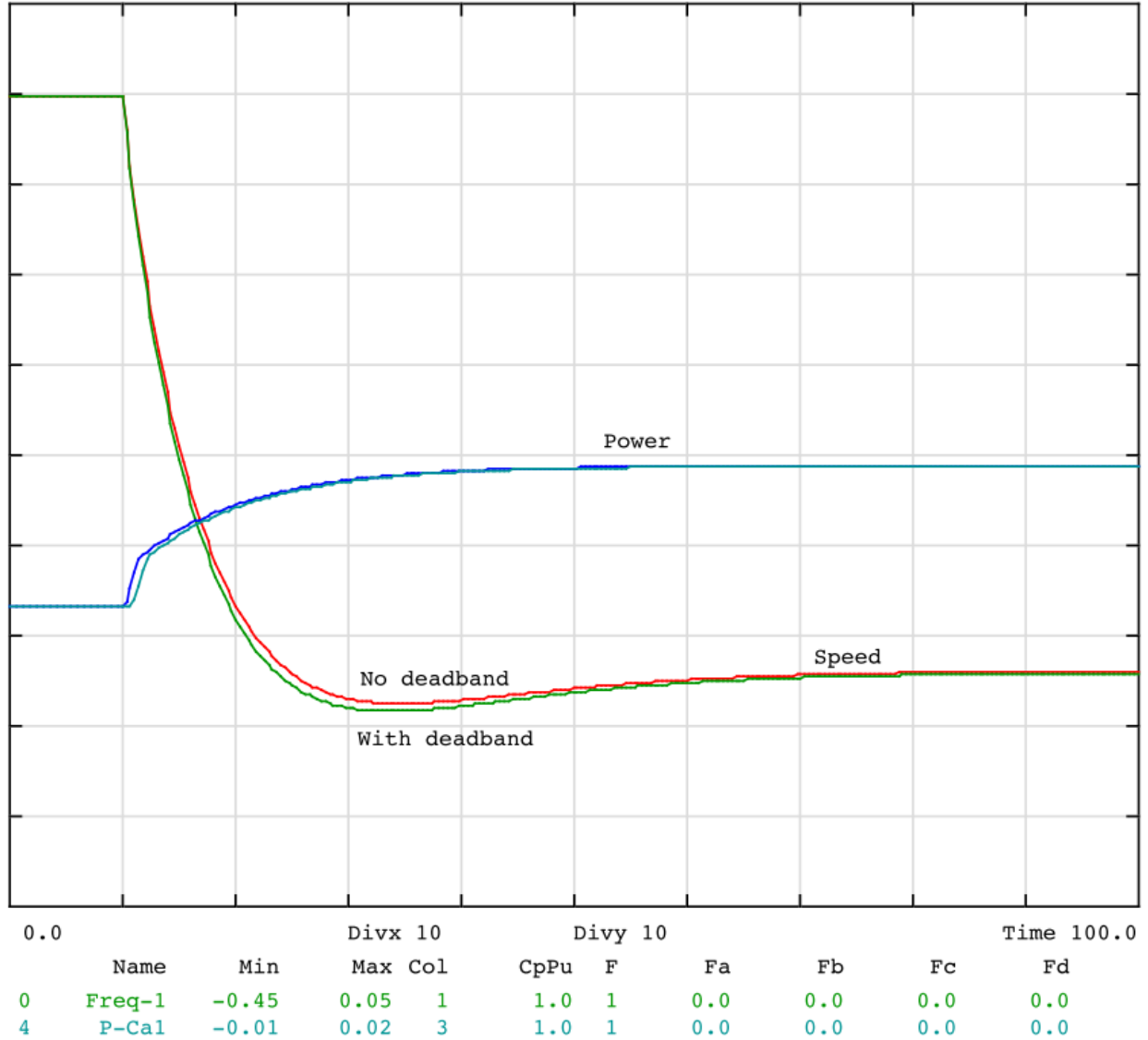
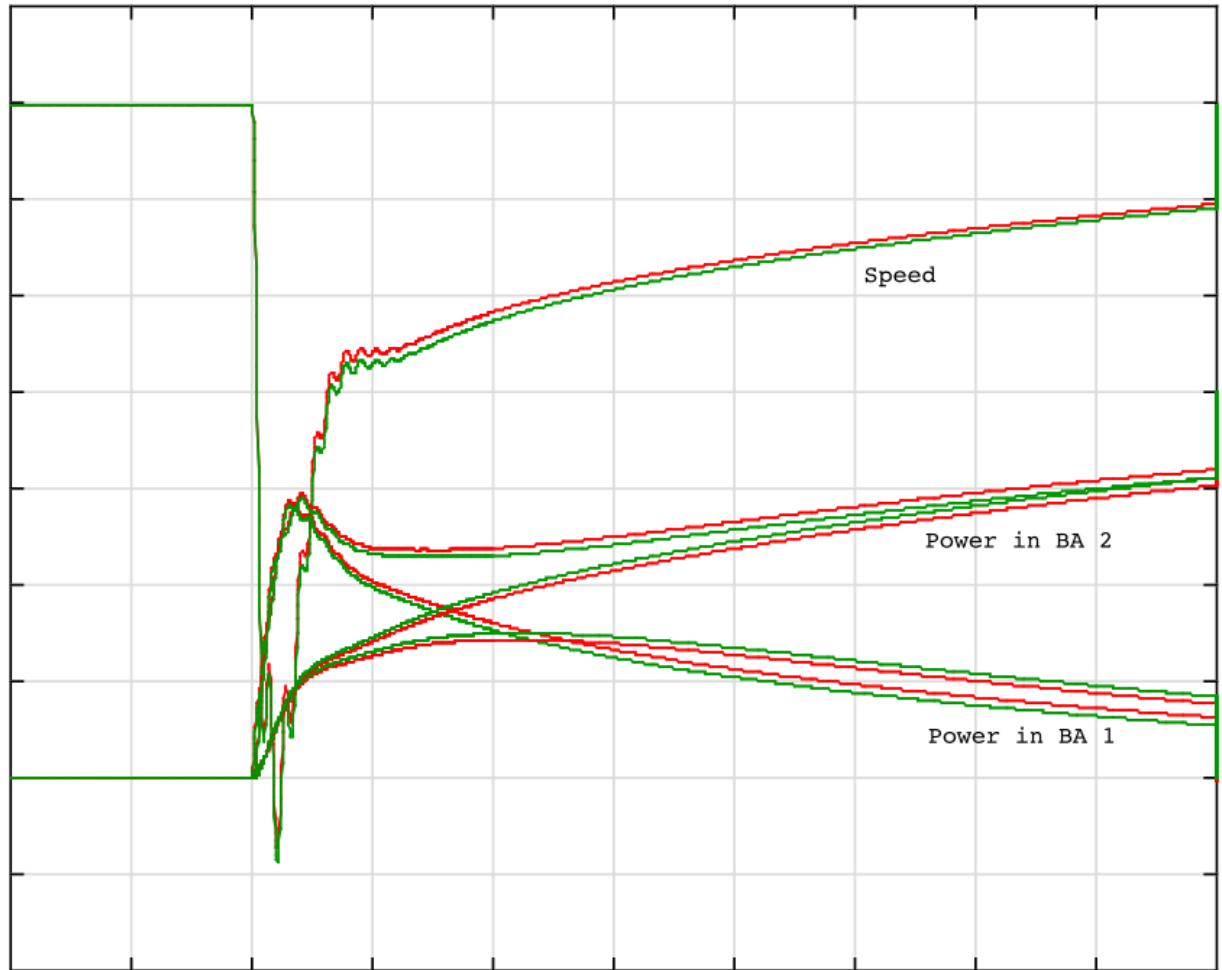

Figure 36. Effect of governor deadband of 0.02 percent speed - limited primary response availability

Single area simulation model - 0.01 per unit load increase
 Red - without deadband (same result as shown in figure 6)
 Green - with deadband



		150.0	Divx 10			Divy 10			Time 400.0		
	Name	Min	Max	Col	CpPu	F	Fa	Fb	Fc	Fd	
0	Freq-1	-0.45	0.05	1	1.0	1	0.0	0.0	0.0	0.0	
4	P-Ca1	-0.01	0.04	1	1.0	1	0.0	0.0	0.0	0.0	
5	P-Cb1	-0.01	0.04	1	1.0	1	0.0	0.0	0.0	0.0	
7	P-Ca2	-0.01	0.04	1	1.0	1	0.0	0.0	0.0	0.0	
8	P-Cb2	-0.01	0.04	<u>1</u>	1.0	1	0.0	0.0	0.0	0.0	

Figure 37. Effect of governor deadband of 0.02 percent speed - LFC active

Two area simulation model - BA 2 loses 0.04 per unit generation

Red - without deadband (same result as figure 16)

Green - with deadband

6.2 Relating it all to Reality

While this discussion has intentionally been at the level of concepts, it is useful to end with a look at reality. The three main interconnections in the US have widely different characteristics in terms of size, type of generation, and transmission configuration. Their responses to generation losses have a range of forms that undoubtedly reflect structural differences in the systems, operating practices, reserve policies, and the many other factors affecting their

behavior. It is encouraging to find that the forms of frequency response produced by the conceptual level model used here are readily related to responses that are observed in the three very different interconnections.

Figure 38 and Figure 39 show responses of the WECC and Texas grids to losses in generation.

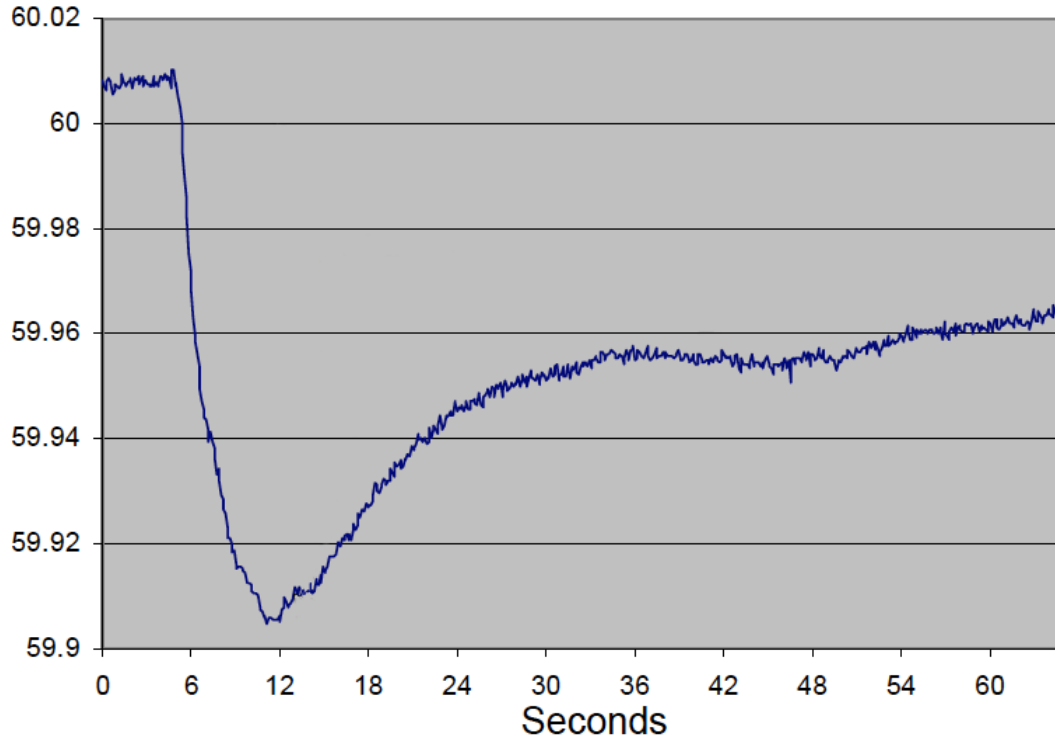

Figure 38. Sample A – Response of WECC system frequency to loss of generation

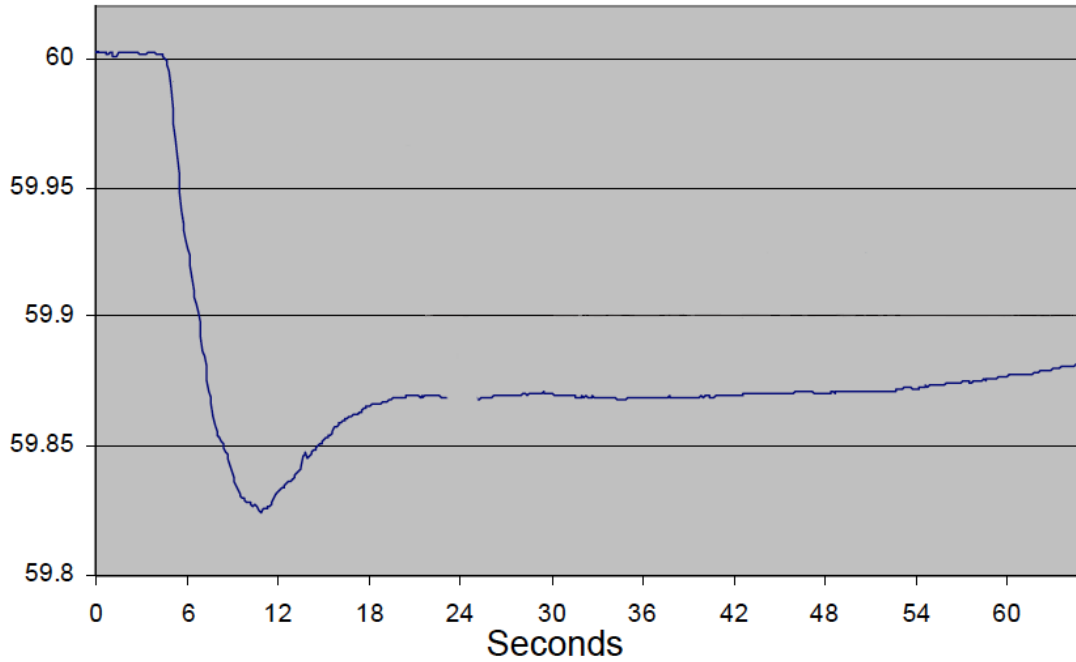

Figure 39. Sample B – Response of Texas system frequency to loss of generation

The form of these responses agrees well with that shown by Figure 5 in section 3.3; it is consistent with sufficient Frequency Response being both available promptly and well sustained after the initial deployment. Both figures indicate satisfactory behavior; figure 39 suggests that a smaller fraction of the connected capacity contributed primary control action in the Texas event than in the WECC one.

Figure 40 and Figure 41 show trajectories of frequency in the Eastern US grid after losses in generation. In these two cases control action overcomes the initial fast decline of frequency but does not subsequently produce an accelerating margin.

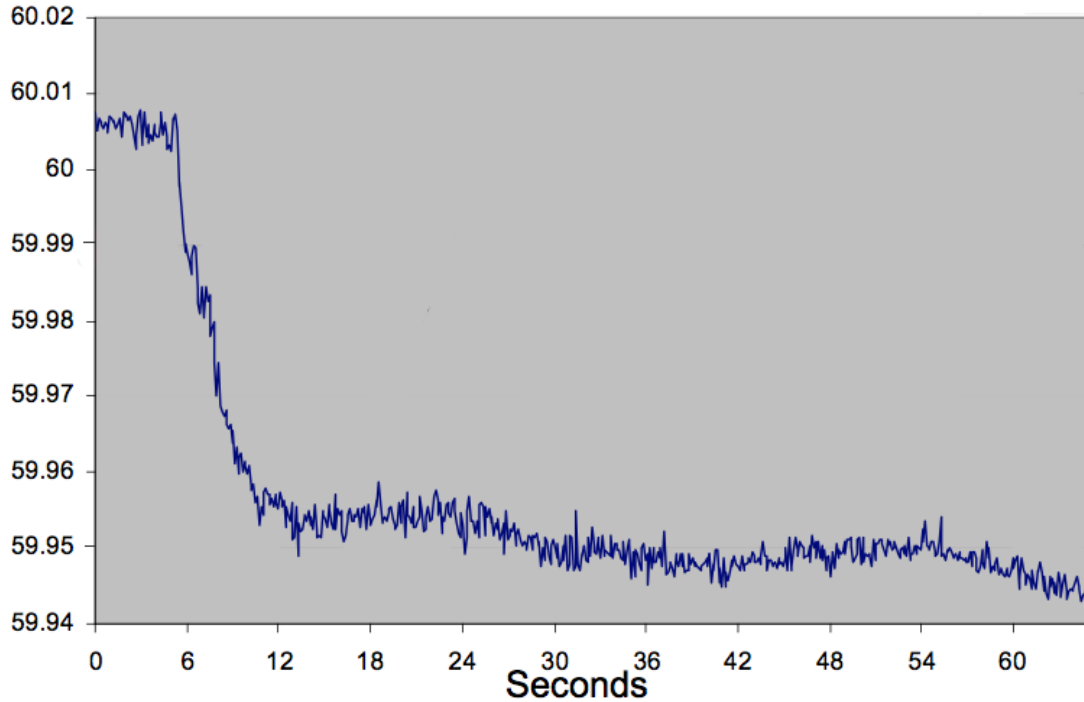

Figure 40. Sample C - Response of Eastern Interconnection frequency to loss of generation

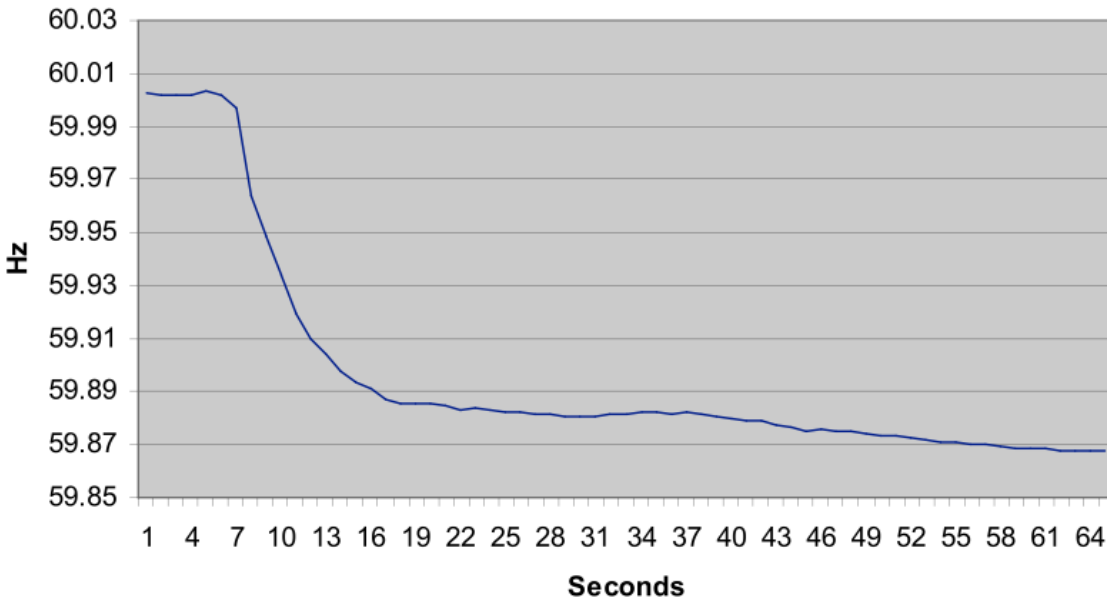

Figure 41. Sample D - Response of Eastern Interconnection frequency to loss of generation

Simulations with the microcosm model give a plausible indication of the cause of this form of response. Figure 42 shows a simulation using system conditions corresponding roughly to Figure 41. It considers an interconnection with a total load of 500,000MW; 5000MW of generation is tripped in a sequence of three events over ten seconds. Twenty percent of the

connected generation is operating in modes that allow it to contribute and sustain primary control response; a further twenty percent contributes primary response initially but has it withdrawn by prescheduled load controls in the generating plants. The form of the simulated frequency transient is a fair match to Figure 40 and Figure 41.

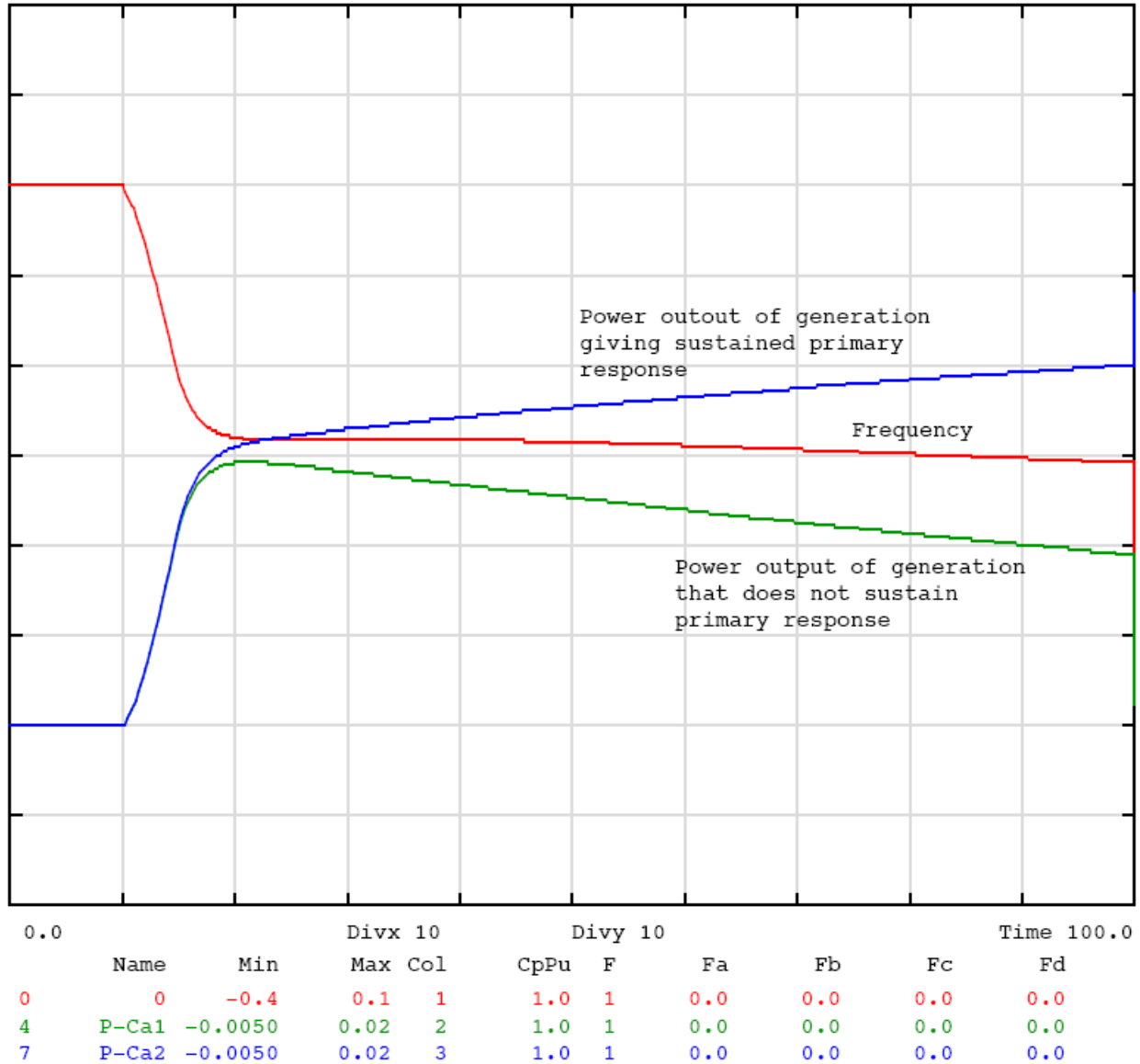

Figure 42. Simulation of response to loss of generation over a 60 second time span reproducing the general form of Figure 35 with simulation of primary control action in absence of load frequency control

Figure 43 extends the simulation for 600 seconds. One set of traces shows the response with a limitation of 1.2 percent of connected capacity on each block, sustaining and nonsustaining, of responsive generation. The other traces were made with unlimited primary response capabilities. Clearly the form of Figure 42 is not the result of limitation on the amount of primary response

capability. Varying the simulation parameters over broad ranges shows that the that the key feature establishing the form of the response is the withdrawal of a significant part of the initial primary response after the initial rapid decay of frequency has been slowed. This causes frequency to drift downward until equilibrium is reached at a value determined by the sustained primary response alone.

The responses shown in Figure 43 are neither acceptable nor a likely representation of what would follow Figure 40 and Figure 41 in reality. The initial transients would be followed up by load frequency control which, given that the loss of 5000MW would have disturbed area net interchanges as well as frequency, would be acting to manage both aspects of system behavior.

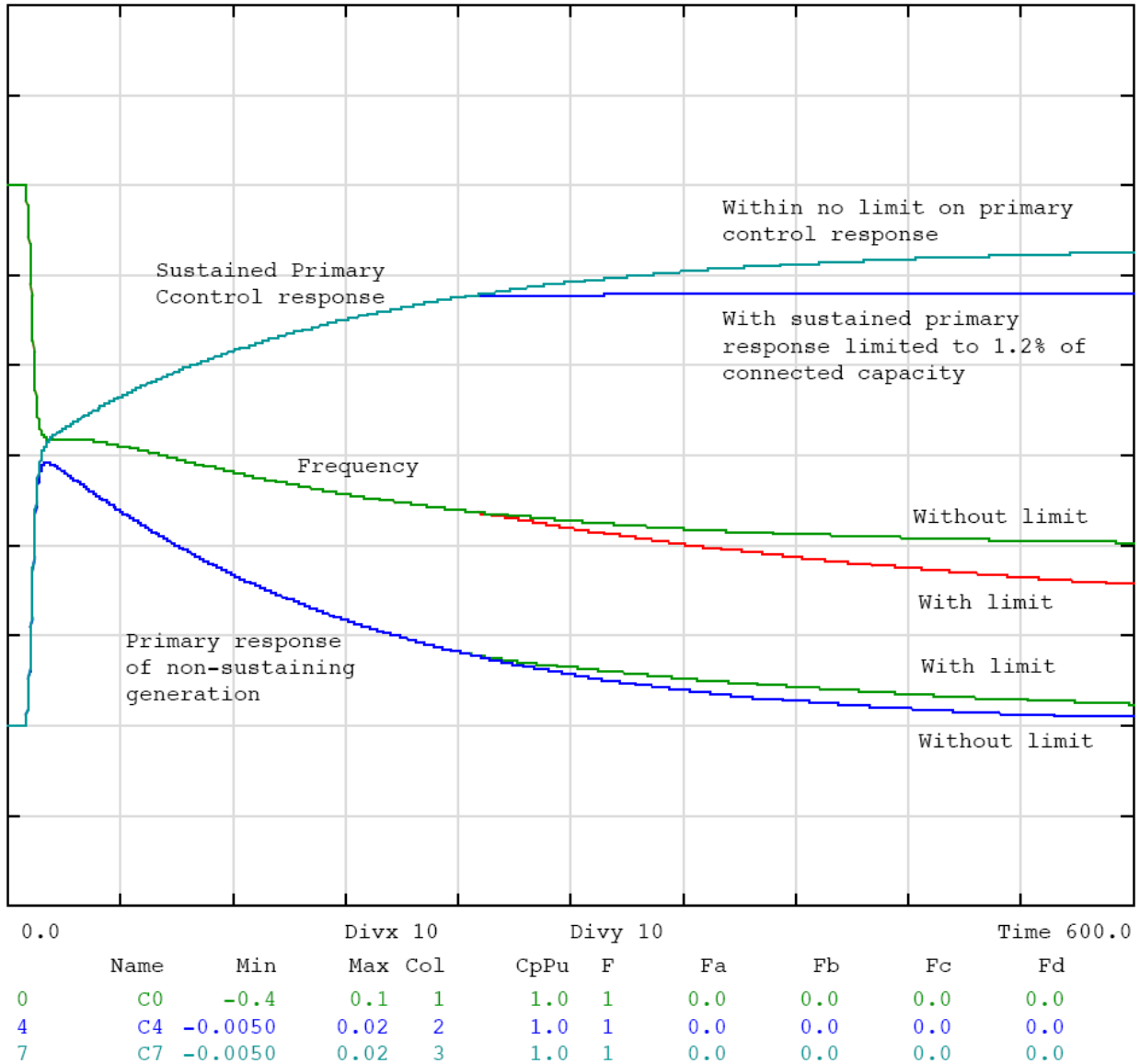

Figure 43. Extension of Figure 37 to 600 second time span with simulation of primary control action in absence of load frequency control

Figure 44 and Figure 45 show a recording of the frequency of the Texas interconnection in the one and ten minute intervals following loss of 750MW of generation. While the time resolution of these plots is barely adequate for diagnosis it is apparent that primary control response arrested frequency at a nadir of approximately 59.83Hz and provided an accelerating margin for several seconds before allowing frequency to go into a slow decline for nearly a minute. Figure 45 shows frequency recovering towards 60Hz as secondary control action (presumably but not necessarily load frequency control) ramps up generation over a period of 4 minutes. Figure 46 shows a simulation of such a situation. As with the 'L-shaped' responses of Figure 40 and Figure 41, varying simulation parameters focuses attention on the withdrawal of primary response as the likely cause of the form of this response.

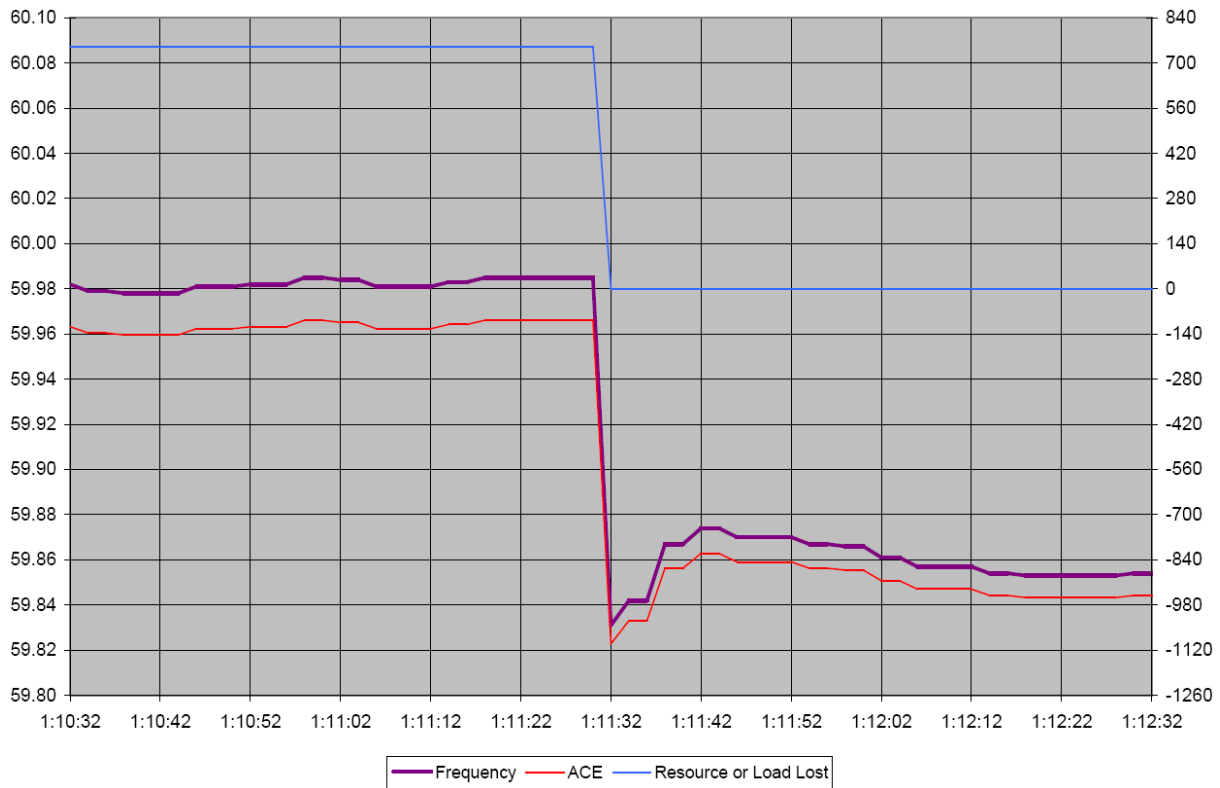

Figure 44. Sample E - Response of Texas system to loss of 750MW over a 120 second time span

Power and Frequency Control as it Relates to Wind-Powered Generation

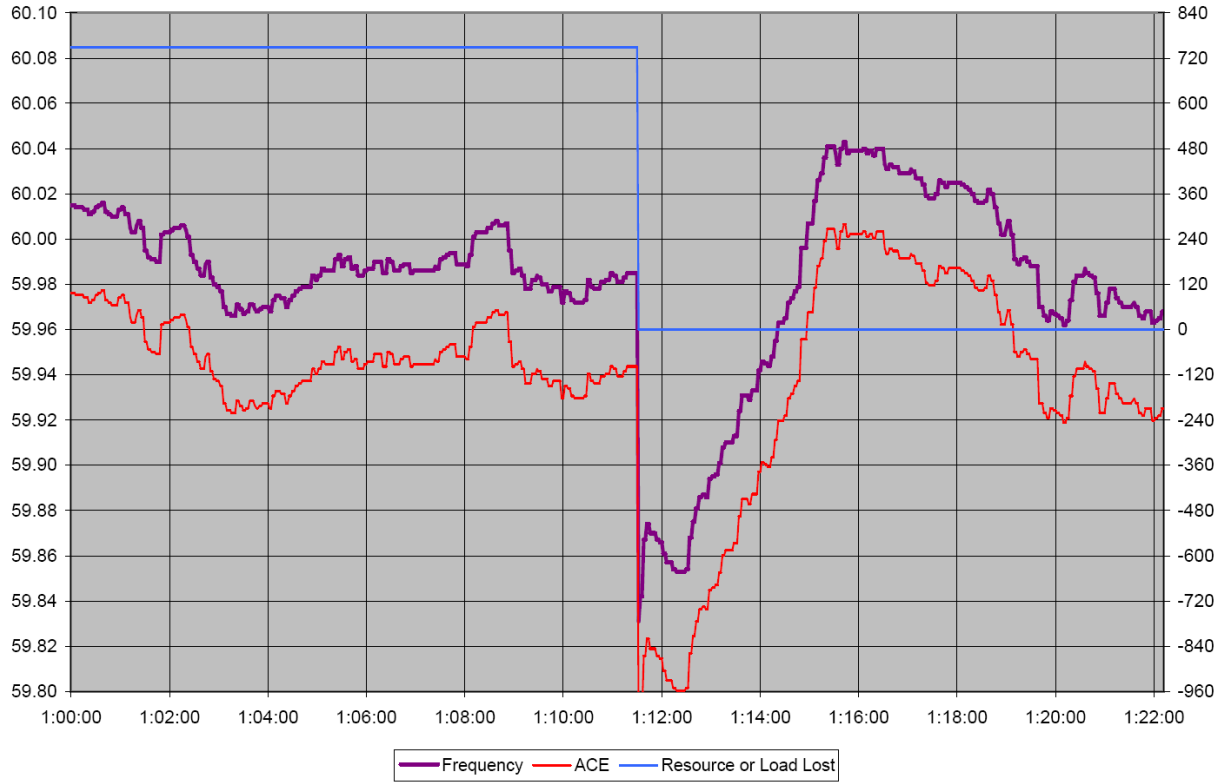

Figure 45. Sample E - Response of Texas system to loss of 750MW over a 22 minute time span

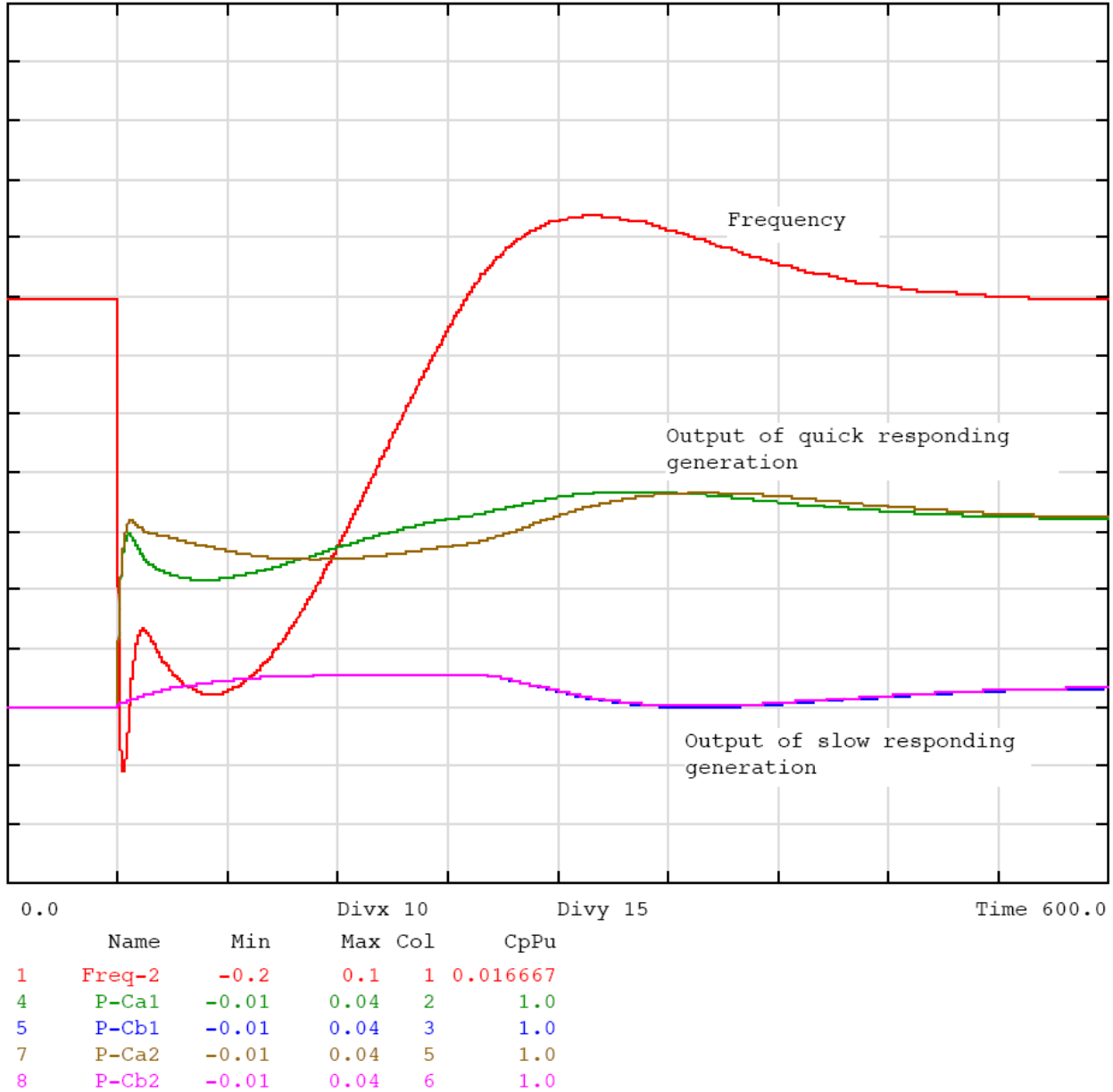

Figure 46. Simulation of Response to loss of generation over a 600 second time span and reproducing the general form of Figure 38

6.3 Relationship between Dispatch and Control

The ability of the power system to exert proper primary and secondary control effort depends on turbines being at part load outputs where they are able to maneuver. It is common for turbines and plants to have load ranges that should be avoided or in which it is impractical to provide secondary control response.

Examples are:

- The rough running bands of hydro turbines
- Loadings of coal burning steam plants at which coal mills must be brought on line
- Loading of oil burning steam plants at which oil guns must be put in service
- Combustion transition bands of large gas turbines with 'dry low NOX' combustion systems

Loading bands such as these are a significant influence on the amount of responsive capacity available to a BA. Dispatch to position turbines appropriately in relation to their maneuverable and restrictive bands should be recognized as an important system reliability requirement. For example dispatch processes and LFC systems should have the capability to decide when a turbine that is being ramped should be 'marched through' an unfavorable loading band. Such actions will be needed increasingly if wind and other variable generation requires quicker and broader ramping of conventional generation. This, in turn, will require the BAs to give plant operators the advance notice that they will need in order to prepare their subsystems for action. (This can include measures such as starting fuel gas compressors, getting shift operators into place and, even, clearing short term work tags.)

7. Commentary and Conclusions

7.1 Requirements for System Control

7.1.1 Control of Frequency and Power Interchanges

The requirement for effective control of grid frequency and of the power flows between BAs is that each BA must be able to count on its generation for primary and secondary control response. Primary control action is continual and, in normal grid conditions, is small in amount. Also, however, primary control response is the essential first response to generator trips and the required amount of primary response capability is set by this function, rather than by what is needed in normal conditions.

Secondary control action is the means by which grid operators adjust the dispatch of power production around the grid. The required amount of secondary control capability is a function of the forecasted load for the day and, with the introduction variable resources like wind power plants, it is also a function of the expected behavior of the variable resources.

7.1.2 Primary Control

There is general understanding and little controversy regarding the required amount of primary control response capability; it must be equal to or slightly greater than the largest credible sudden loss of generator power. This required amount is not dependent on system load.

While the required amount of primary response capability is well understood, it is less well understood that primary response duty must be allocated among turbines with careful regard for the number of contributing turbines and the dynamics (that is, timing) of how it is delivered.

First, the primary response of a turbine is proportional to the deviation of its speed from schedule. Consequently, the amount that grid frequency must dip to cause the production of a given amount of primary response is inversely proportional to the fraction of the connected capacity from which the primary response is drawn.

Second, the promptness with which a turbine can deliver its primary response is strongly dependent on the amount of the delivery. The great majority of turbines can produce a primary response of a few percent of their rating on a time scale of seconds but most, also, are limited in their rate of response once outside a band of a few percent.

Both of the foregoing factors make it important that the primary response capability requirement of the BA be obtained by allocating a quite small primary response duty to the largest possible number of turbines, as distinct from expecting it to be produced by larger maneuvers by a small number of turbines.

In addition to being adequate in amount and capable of appropriately prompt response, primary control capability must also be distributed geographically so that its deployment does not reduce

the security of the transmission grid. This transmission-related issue is outside the scope of this discussion; it is sufficient to note that proper geographic distribution of primary response capability in relation to transmission corridors is as important as the requirements regarding its amount and responsiveness.

7.1.3 Secondary Control

Two very distinct forms of secondary control must be recognized:

- a. The power output of turbines is pre-scheduled and hourly or daily profiles of power output are followed by power plants by means of secondary control systems (DCS in plant terminology) within the plants. This is open loop control with respect to the BA.
- b. The power output of turbines is maneuvered continually by the action of the BA's LFC system. This is feedback control with respect to the frequency of the grid and the net interchange of the BA.

The amount of secondary control response capability required and the rate at which it must be delivered have historically been functions of the daily load forecast, allowance for error in the forecast, and provision for contingencies such as transmission limitations that might require emergency changes in net interchange schedules. The introduction of variable resources surely adds a new and potentially large component to the requirement for secondary response with respect to both amount and rate of delivery.

The division of secondary control between the use of prescheduled power delivery profiles and LFC is important and this importance is greatly increased as the amount of variable resources (wind) is increased in a BA. Imperfection in matching prescheduled ramping of generation to the load profile must be corrected by LFC action or, in the last resort, by primary control response. The correct operation of the system is for LFC to handle as much as possible of the imperfection, thus minimizing the use of primary response capability. Excessive reliance on prescheduled management of plant outputs both increases the likely amount of dispatch imperfection and removes turbine capacity from the resource pool available to correct it.

7.1.4 Wind Plant Control Response

This memorandum has chosen to ascribe neither favorable nor detrimental characteristics to wind plants with respect to the control of real power. It has taken the view that wind power plants will make no contribution to primary or secondary control of real power in the sense of Frequency Response. A further assumption is that, while their output will vary as a function of the wind, the wind will be averaged spatially across the grid and the collective variation of wind power will take the form of ramps at rates that are slow in relation to the time scale of the primary control action.

It is certain that wind plants control systems will evolve to be able to manipulate the electrical power delivered to the grid². Depending on the priorities adopted in these controls they have the potential to be favorable or detrimental to the control of grid frequency.

As in all power plants, the primary responsibility of plant controls will be the safety, efficiency, and longevity of the equipment in the plants. Large size, top heavy configuration, erection processes, and the unsteady character of wind conspire to make fluctuating loadings and fatigue a matter of significant concern in wind plant structures. The maneuvering of wind turbine pitch and of electrical power output can be used to exert a degree of control over loads and stresses in the structures, to create a grid-oriented relationship between electrical power and frequency, or to provide a mix of these actions.

There are at least two possibilities by which a wind plant would be able to offer the ability to increase output in response to a dip in frequency:

- by operating below its maximum output for the present (momentary) wind condition and using pitch control to increase its power output
- by maneuvering its electronic converters to increase electrical power output and borrowing the required mechanical input from the kinetic energy stored in its rotors

Both of these approaches might allow a wind plant to offer quick response to a frequency dip and this would be favorable to the grid. However both approaches will inevitably be subject to in-plant constraints such as limits on coupling torques and turbine aerodynamic limits, for example. Further, pitch control can only increase turbine power if the wind is favorable at the moment and response provided by borrowing energy from the rotors cannot be sustained beyond a few seconds. Not only will real power obtained by borrowing rotor energy have to be withdrawn; it will be necessary to reduce electrical power output to reaccelerate the rotors.

Thus, Frequency Response capability offered by a wind plant will not be the same as the primary control capability of conventional plants. While primary response capability offered by a conventional plant can be counted on with good assurance once the appropriate control modes are selected by its operator, the response capability of a wind plant will always be conditional on the statistics of the wind.

Control actions within a wind plant will have aspects that are averaged out by the spatial diversity of the wind across the plant site and aspects that are coherent across the many towers. Actions related to load management at individual towers could be averaged-out at the plant's point of grid connection if wind gusts are spatially diverse across the plant. Actions related to general wind velocity at the high or low limits of the operating range may be simultaneous across the site and therefore fully apparent at the point of interconnection. Control actions to provide

² www.gepower.com/businesses/ge_wind_energy/en/technology/index.htm,
www.vestas.com/en/wind-power-solutions/vestas-technologies/optispeed.aspx

Frequency Response to the grid will be simultaneous across the site. Whether internal plant-related controls permit or inhibit the provision of Frequency Response by a wind plant will depend on the spatial and temporal statistics of the wind on the scale of the plant site.

That the control capabilities offered to the grid by wind plants will be conditioned by plant-scale wind statistics must be recognized but should not be cause for undue pessimism. At present, the fund of statistical information on the spatial and temporal statistics of wind on the size scale of a plant and the time scale of grid frequency control (5-30 seconds) is not a sufficient basis for sound judgements. Hence, this report has chosen to ascribe neither favorable nor detrimental characteristics to wind plants with respect to the control of real power.

Improvements in electronic converters and controls that enable wind plants to 'ride through' the voltage depressions caused by transmission faults have been important as wind generation has gone from being a negligible amount of capacity dispersed in sub-transmission and distribution circuits³ to providing significant blocks of generation at the transmission level. The likelihood that a transmission fault will deprive the grid of a large block of wind capacity is now essentially the same as, or less than, the likelihood that it will cause tripping of conventional plants. Beyond that, the ability of a wind plant to ride through an electrical fault has little to do with the way a large amount of wind capacity will affect the control of grid frequency.

The present rapid evolution of the wind power industry creates both opportunities and risks in regard to the development of controls. Open communication between manufacturers and grid operators is essential. Manufacturers should carefully explain the things they must do to protect equipment, those that are advantageous if done but not essential, and those that they cannot do. Grid operators should present the manufacturers and plant developers with clear statements of what are needed as well as quantitative definitions of the response criteria.

Evolution of wind plant controls in the absence of careful guidance regarding grid requirements carries a significant risk that controls developed with the best intentions regarding the wind plant equipment will have unintended adverse consequences in terms of the control the interconnected power systems.

7.2 Wind Power in Relation to System Control

It would be ideal if all turbines could be counted on to provide both primary and secondary response at all times. In practice, though, many power plants do not provide these services because of inherent design or operational restrictions. Wind power plants are one, among several, of the types of plant that do not offer ideal control capabilities.

The objective of this discussion has been to illustrate the way a number of key factors in the management of control resources affect the grid, so that the effects of wind power plants can be seen in perspective with other influences on grid control.

³ Electrical safety demands that all dispersed generation be disconnected from a circuit when it is faulted.

Wind power plants have three notable characteristics:

- a. They are very limited in their ability to provide primary and secondary control response to the grid.
- b. The output of a large geographically concentrated block of wind generation can increase or decrease very quickly in comparison to normal load ramping rates. To compensate for this variation, the grid must be prepared to ramp non-wind generation over a substantial range at faster rates than needed to follow daily load variation.
- c. While variation in wind power production can be predicted on the time scale of hours it cannot be predicted within minutes as to when it will occur.

With respect to point a, this discussion regards wind power plants as having no ability to provide primary or secondary control response. This is undoubtedly conservative, and the provision of primary and secondary control capability by wind plants can be considered in due course. The statistical analysis of point b. is receiving great attention at present. Information on high rates of ramping is still isolated and anecdotal. Wind forecasting appears largely to be an analytical process that supports the common sense view of point c.

Point c is of great importance to this discussion. While the daily scheduling of power system operations is done many hours in advance and power plant operators depend on advance notice to prepare their in-plant systems, adjustments to accommodate unscheduled events must be made on a time scale of minutes or seconds.

That a large change in the production of wind power is occurring cannot always be clear to the minute to operators. Rather, a significant change in the wind is most likely to become apparent over a time scale of several minutes. The forecasting, scheduling, and command facilities of a BA will certainly react to a change of wind production once it has become clearly apparent. It seems inevitable, however, that there will be periods when reaction to a change in the wind will lag the first variations in wind plant output by a few minutes. Effective LFC in these intervals will be essential.

7.3 Wind Plant Characteristics in Perspective

Recent broad discussion of wind power has brought to light a number of issues relating to system control that need attention regardless of the introduction of wind-powered, solar, or other variable-output generation. It is somewhat misleading to single out wind power plants as reducing the control resources available to the power system. The list of plant classes, plant operating regimes, environmental issues, and economic realities that result in plants not providing control services is long and varied.

That wind plants do not provide these services must be viewed in relation to issues such as these:

- The fraction of the fleet that does not provide primary response has grown significantly in the last ten years with the widespread introduction of large combined cycle plants. The steam turbines of these plants are most often operated with their valves either wide open or controlling steam pressure. In both cases they provide no useful primary response and contribute to secondary response only with long time constants.
- Nuclear plants are normally operated at constant power with their turbine control valves being used to control steam pressure; in this mode they provide neither primary nor secondary response.
- Large coal plants are run at maximum output as much because constant power operation minimizes many causes of unplanned outages as because of their competitive production cost. When at maximum output they do not provide control response.

This discussion of system control, therefore, does not focus on specifics of wind plants. Rather, it looks at the effects on the system of changing the proportions of generation that provide primary and secondary response. The introduction of large wind plants in a BA may or may not change these proportions. When wind power production replaces the output of coal plants it is likely that the net change to the amount of responsive capacity in the fleet will be minimal. Replacing hydro power with wind power, in contrast, is likely to reduce both primary and secondary control resources available to the system.

7.4 Options for Adaptation to Variable Resources

It can reasonably be assumed that variable resources, including wind power, will be connected into the grid by transmission arrangements that do not increase the likely sudden loss of generation beyond the size of the current largest credible event. Given this, the illustrative sensitivity studies shown in this discussion indicate that the introduction of wind power will make it important to emphasize the timeliness with which primary response is delivered, but will not require any large change in the required amount of primary response capability.

The fact that variable resources are expected to require increased rates of ramping of turbine output will require significant adaptation, however. To provide the capability to ramp power at newly required rates over wider ranges than have been the historical norm, it will be necessary to either:

1. operate a larger amount of on-line capacity at part load, so as to be immediately ready to provide secondary response, or
2. to depend increasingly on quick start generating units to provide a significant part of the required ramps

It may appear that the two approaches can be evaluated and compared on the basis of expected capital and operating costs. The prudence of this is questionable, however, because it would fail to recognize the very great difference between the two approaches from the viewpoint of primary and secondary control capability. The use of quick start generation to deal with unanticipated

requirements exposes the system to the risks associated with the impossibility of forecasting variable resource events 'to-the-minute'. Management of this risk will require that quick-start turbines and prescheduling of the output of on-line turbines be used only to the extent that it is possible to provide coordinated assignments of LFC duty to turbines that are on-line and in their maneuverable load ranges.

7.5 Quantitative Assessments

The simulations shown in this discussion have been illustrative. They indicate, in principle, what can be expected as the proportions of capacity providing primary and secondary response are varied, but they have not been pursued to the extent that would be needed to support quantitative recommendations on amounts of primary and secondary response capability.

The current state of analysis in the industry is somewhat adequate for assessment of the primary response needed to handle the trips of major generators. These assessments require the simulation of 20 to 40 seconds of real time and can be done in the currently available large scale grid simulation programs. These programs can provide a reasonable representation of primary control action when provided with proper data on turbines and governors.

With regard to secondary control, analytical simulations in which system elements are modeled in detail have been less useful and are less promising. Because it must look tens of minutes or hours ahead of initial conditions, analysis of secondary response inevitably requires judgements as to what grid operators, plant operators, and the citizens consuming power will do. In this context simulations are more useful if they are simple, quick, and suitable for use as a compliment to strong practical knowledge of power plant operations.

The note that can be made here regarding quantitative requirements for primary response and LFC comes from operating experience rather than analysis. There are concrete indications currently that the fractions of generating capacity providing primary and LFC response in some large grids are approaching a practical minimum, regardless of the introduction of wind or other new classes of generation. The European "Frequency Quality Investigation" (see reference 5) raises concern that prescheduled maneuvering of turbines has brought the amount of capacity providing LFC service to an acceptable minimum. The 'L-shaped' frequency dip responses seen in the Eastern US suggests that there might be inadequate primary response capability in that grid.

7.6 Qualitative Remarks

The variability of wind generation will require careful attention to the provision of both reserves for control and the dynamics of control. The impact of wind powered generation on reserve requirements is the subject of wide discussion at present. It is important that the discussion recognize that having enough reserves to cover expected variations of wind power is not sufficient on its own. Proper dynamic characteristics and control capabilities will be as important as the level of reserves.

The introduction of wind powered generation will not greatly increase the amount of reserve required for primary response to frequency variations but it will certainly increase the importance of the primary response being delivered promptly and with proper geographic distribution. A high proportion of wind powered generation will require renewed attention to secondary control capability. It will be important to recognize the distinction between the using plant controllers to hold turbines to prescheduled output profiles and control by the LFC systems of the BAs.

The required attention to system control should involve the following:

- a. BAs should be continually aware of the primary response capability in effect, both as a total for the area and by individual turbine.
- b. BAs should be continually aware of the secondary response capability in effect, both as a total for the area and by individual turbine.
- c. Plant load control systems should be required to operate with proper frequency bias when running in local preselected load control mode.
- d. The allocation of secondary control responsibility between prescheduling of plant outputs and LFC should give precedence to reliability principles over market concepts; excessive use of prescheduling should be avoided.
- e. The control mode status of all plants with respect to primary control, local load control, and LFC should be reported continually and currently to BA control centers.
- f. The terminology used to describe plant control modes and status should be standardized nationally.
- g. Plant operating and engineering staffs should be knowledgeable about the ways their control actions affect the security and reliability of the grid.
- h. BA operating staff should be continually sensitive to the response that the plants will be able to deliver and should have clear authority, based on the overriding principles of reliability, to require plants to operate at outputs and in control modes that may differ from the indications of markets. Presecheduling and dispatch of generation resources should aim to minimize the ordering of output changes and changes of control mode on short notice.

References

1. Kirchmayer, L. K, Economic Control of Interconnected Systems, New York, John Wiley and Sons, Inc. 1959.
2. Cohn, N., Control of Generation and Power Flow on Interconnected Power Systems, Second Edition. John Wiley & Son, Inc., New York. 1971.
3. deMello, F. P. and J.M. Undrill. 1975. "Automatic Generation Control", IEEE Tutorial Publication, IEEE Winter Power Meeting.
4. UCTE (Union for the Co-ordination of Transmission of Electricity). 2009. "UCTE Operation Handbook – P1 - Policy 1: Load-Frequency Control and Performance". http://www.entsoe.eu/fileadmin/user_upload/_library/publications/ce/oh/Policy1_final.pdf.
5. UCTE (Union for the Co-ordination of Transmission of Electricity). 2008. "Frequency Quality Investigation - Excerpt of the Final Report". <http://www.entsoe.eu>.

Appendix A. The Dynamic Simulation Model

The simulation model considers the power system to consist of two BAs as shown in Figure 2. Each BA consists of a single connection point for three turbine-generators. Each of these turbine-generators represents the collective output of the turbines of one of the three types listed in Section 2.2. The turbine-generators in a BA all run at the same speed. The total (load plus losses) of each BA is connected at the same point as the generators and the transmission connecting the two areas also terminates at this point. The turbines of each BA run at a common speed but the common speeds of the two areas are not necessarily the same. The power flow on the intertie transmission path is proportional to the electrical phase angle between the electrical connection points in the two areas. The phase angle varies as the speeds of the two BAs oscillate with respect to the average speed of the entire system. Figure A- 1 shows the overall structure of the simulation model.

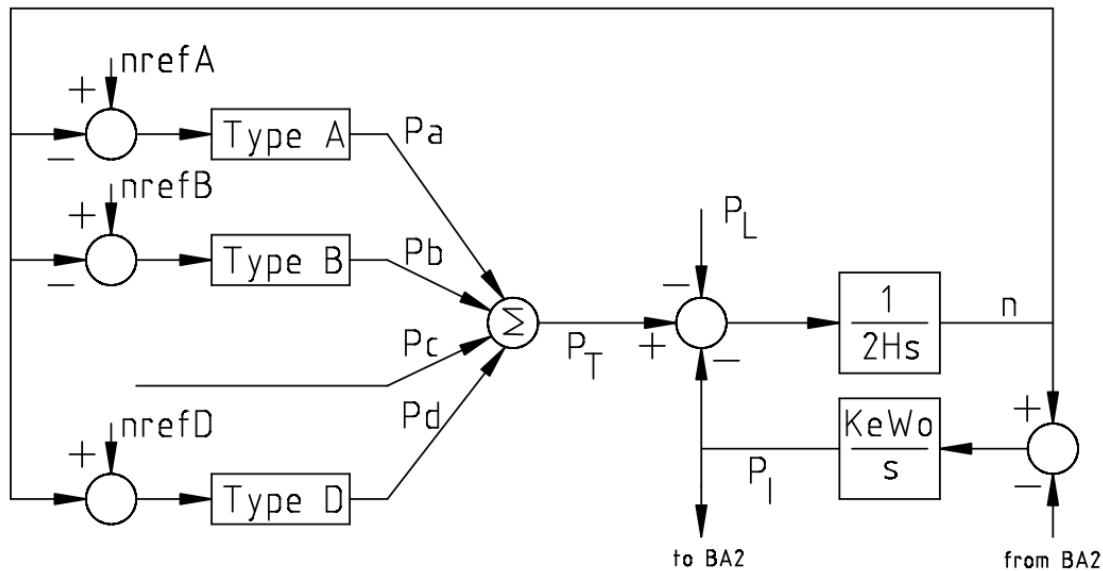

Figure A- 1. Energy balance representation of power and speed behavior

The type A and type B turbines are receptive to secondary control via incrementing or decrementing their governor speed-load references, nref. Secondary control can be provided by pre-scheduled changes (step and/or ramp) of the speed-load references, or by LFC. Pre-scheduled changes are a simple representation of the way a plant is managed by its own operator on the basis of load schedules that are provided in advance and implemented on an open-loop basis. LFC is feedback control of the synchronous speed of the system and of the power flow in the intertie.

Each BA has a simple LFC system of the form shown in Figure A- 2. Each of the responsive turbines can be assigned to participate in LFC.

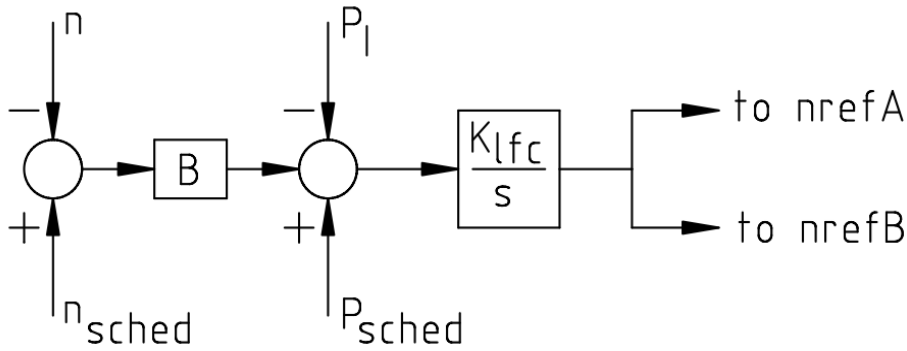
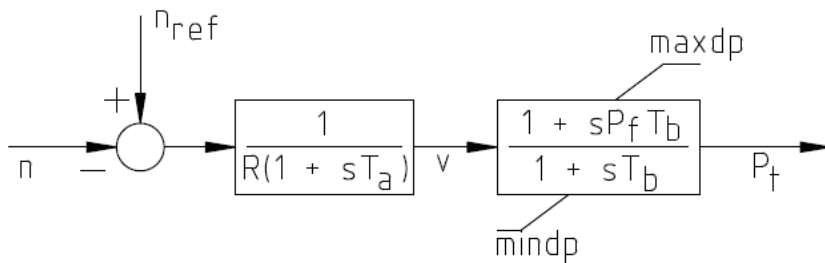

Figure A- 2. Very simple load frequency control model

The model operates in terms of deviations from an initial equilibrium condition but provides for limitation of rate of change of turbine output and for maximum output limits. Separate rate and amount limits are placed on each turbine.

The response of the type A and B turbines is modeled by the transfer functions shown in Figure A- 3.



Type A Response
 $T_a = 0.5$ $T_b = 10.0$ $P_f = 0.3$

Type B Response
 $T_a = 2.5$ $T_b = 40.0$ $P_f = 0.1$

Figure A- 3. Simple transfer function representation of turbine dynamic response